

627/628 SERIES



D-Sub Connectors: Vertical, Plastic Body

Features:

- 0.109"(2.77mm) contact spacing x 0.112"(2.84mm) row spacing
- Standard profile plug and receptacle in 9, 15, 25 and 37 contact sizes
- Pin and socket contact mating design with P.C. tail termination
- Metal shell provides EMI/RFI shielding, plug shell indents provide grounding and additional mating retention
- Grounding features include boardlocks for exceptional retention to P.C. board
- Flange mounting options for panel mount or connector mating include threaded hole and threaded standoff
- D-shaped connector mating outline provides polarization
- Design based on requirements of MIL-C-24038, EIA RS-232 and RS-449



Specifications:

Insulator Material	Thermoplastic Polyester, UL 94V-0, Chemical Resistant, Color: Black
Contact Material	Plug (Pins): Brass Receptacle (Socket): Brass
Contact Plating	Selective Gold (See Ordering Code) over Nickel for the Mating Area, Tin Plating for Tail Area
Shell Material	Nickel Plated Steel (Optional Tin Plating)
Current Rating	3 amps
Contact Resistance	25 Milliohms maximum
Insulation Resistance	5000 megohms minimum
Dielectric Withstanding Voltage	1000 V AC rms at Sea Level
Operating Temperature	-55°C To +85°C
Insertion Force	16 oz (4.45 N) Maximum Per Contact Position
Withdrawal Force	1 oz (0.28 N) Minimum Per Contact Position

Ordering Code:

627-025-220-013

SERIES:
627: PLUG (PIN)
628: RECEPTACLE (SOCKET)

NO. OF CONTACTS:
009 - 9 CONTACTS 025 - 25 CONTACTS
015 - 15 CONTACTS 037 - 37 CONTACTS

CONTACT FINISH CODE:
2 - GOLD FLASH PLATING
3 - 15 MICROINCHES OF GOLD PLATING
6 - 30 MICROINCHES OF GOLD PLATING

CONTACT CODE:
20 - .105"(2.67mm) TO .160"(4.06mm) PC TAIL
24 - .169"(4.30mm) TO .189"(4.80mm) PC TAIL
26 - PRESS FIT CONTACT
27 - IDC

FLANGE MOUNTING OPTIONS:
2 - #4-40 THREADED HOLE
3 - #4-40 THREADED STANDOFF
6 - #4-40 THREADED HOLE WITH BOARDLOCKS
7 - #4-40 THREADED STANDOFF WITH BOARDLOCKS

PROFILE:
1 - STANDARD PROFILE

SHELL PLATING:
0 - NICKEL PLATED SHELL
2 - TIN PLATED SHELL

FLANGE MOUNTING OPTIONS

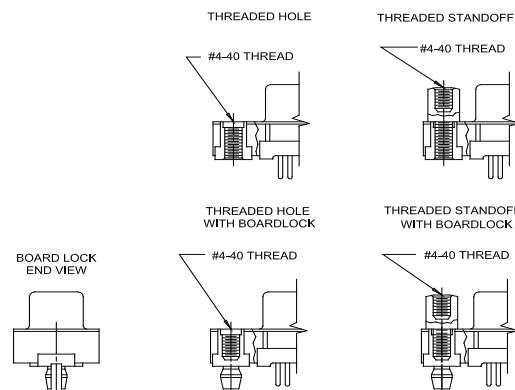

PLUG 627 SERIES

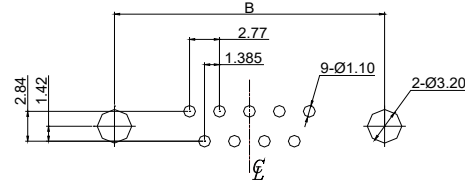
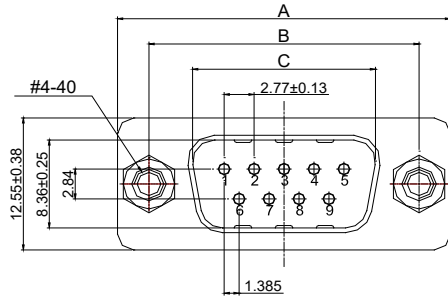

Recommended PCB Layout
(Plug and Receptacle)

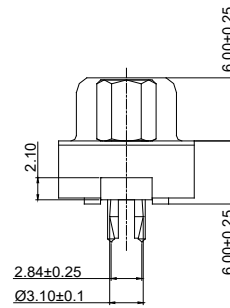
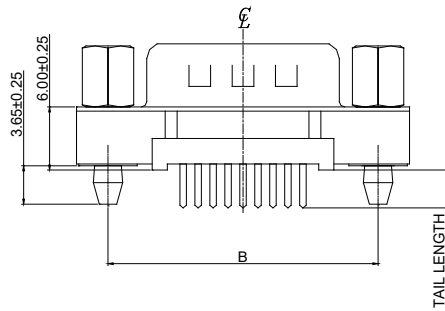

RECEPTACLE 628 SERIES

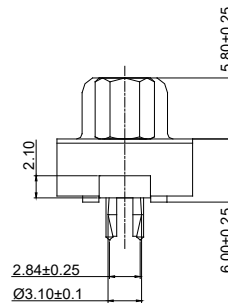
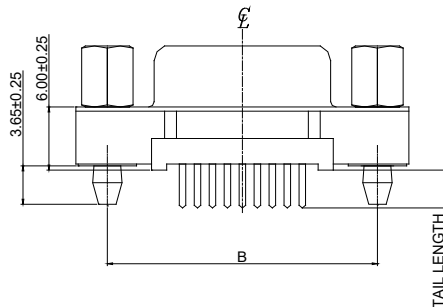
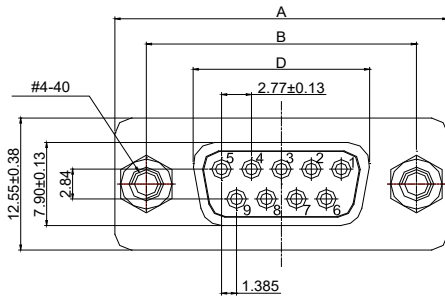

NUMBER OF CONTACTS	A±0.38		B±0.25		C±0.25 PLUG		D±0.13 RECEPTACLE	
	Inch	(mm)	Inch	(mm)	Inch	(mm)	Inch	(mm)
9	1.213	(30.81)	.984	(24.99)	.666	(16.92)	.643	(16.33)
15	1.543	(39.19)	1.312	(33.32)	.994	(25.25)	.971	(24.66)
25	2.088	(53.04)	1.852	(47.04)	1.534	(38.96)	1.534	(38.96)
37	2.729	(69.32)	2.500	(63.50)	2.182	(55.42)	2.159	(54.84)