

## SPDT SWITCH GaAs MMIC

### ■ GENERAL DESCRIPTION

The NJG1801K75 is a SPDT switch IC suited for switching transmit/receive signals at 802.11 a/b/g/n/ac/ax, Bluetooth, UWB and others wireless communication application.

The NJG1801K75 features low insertion loss, high isolation, and high handling power.

This switch exhibits wide frequency coverage up to 8.5GHz. And the ultra small and ultra thin package of DFN6-75 is adopted.

### ■ PACKAGE OUTLINE

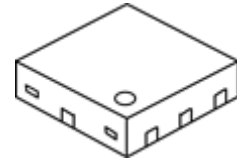

NJG1801K75

### ■ APPLICATION

WLAN 802.11a/ b/g/n/ac/ax, Bluetooth, UWB networks  
 Communication Modules, Smartphones, Access points, and others mobile devices  
 Antenna switching, Transmit / receive switching, path switching applications

### ■ FEATURES

- Control voltage range 1.8 to 5.0 V (3.0 V typ.)
- Low insertion loss 0.35 dB typ. @ f = 2.4 to 2.5 GHz  
 0.45 dB typ. @ f = 4.9 to 5.9 GHz  
 0.60 dB typ. @ f = 8.5 GHz
- High isolation 28 dB typ. @ f = 2.4 to 2.5 GHz  
 30 dB typ. @ f = 4.9 to 5.9 GHz  
 20 dB typ. @ f = 8.5 GHz
- P-1dB P<sub>-1dB</sub> = +31 dBm typ. @ f = 2.5 GHz  
 P<sub>-1dB</sub> = +31 dBm typ. @ f = 5.9 GHz
- Ultra small & ultra thin package DFN6-75 (Package Size: 1.0 x1.0 x 0.375 mm typ.)
- RoHS compliant and Halogen Free, MSL1

### ■ PIN CONFIGURATION

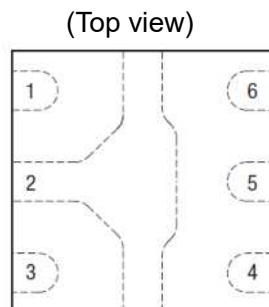

Pin connection

1. P1
2. GND
3. P2
4. VCTL2
5. PC
6. VCTL1

### ■ TRUTH TABLE

“H” = V<sub>CTL</sub>(H), “L” = V<sub>CTL</sub>(L)

| ON PATH | VCTL1 | VCTL2 |
|---------|-------|-------|
| PC-P1   | L     | H     |
| PC-P2   | H     | L     |

NOTE: Please note that any data or drawing in this catalog is subject to change.

## ■ ABSOLUTE MAXIMUM RATINGS

$T_a = +25^\circ\text{C}$ ,  $Z_s = Z_l = 50\ \Omega$

| PARAMETER             | SYMBOL    | CONDITIONS   | RATINGS     | UNITS            |
|-----------------------|-----------|--|-------------|------------------|
| RF Input Power        | $P_{IN}$  | $V_{CTL(L)} = 0\ \text{V}$ , $V_{CTL(H)} = 3.0\ \text{V}$ ,<br>ON State Port   | +31         | dBm              |
| Control Voltage       | $V_{CTL}$ |  | 6.0         | V                |
| Power Dissipation     | $P_D$     | 4-layer FR4 PCB with through-hole<br>(76.2x114.3mm), $T_j = 150^\circ\text{C}$ | 380         | mW               |
| Operating Temperature | $T_{opr}$ |  | -40 to +105 | $^\circ\text{C}$ |
| Storage Temperature   | $T_{stg}$ |  | -55 to +150 | $^\circ\text{C}$ |

## ■ ELECTRICAL CHARACTERISTICS1 (DC CHARACTERISTICS)

(General conditions:  $T_a = +25^\circ\text{C}$ , with application circuit)

| PARAMETERS             | SYMBOL       | CONDITIONS | MIN  | TYP | MAX | UNITS         |
|------------------------|--------------|------------|------|-----|-----|---------------|
| Control Voltage (HIGH) | $V_{CTL(H)}$ |            | 1.8  | 3.0 | 5.0 | V             |
| Control Voltage (LOW)  | $V_{CTL(L)}$ |            | -0.2 | -   | 0.2 | V             |
| Control Current        | $I_{CTL}$    |            | -    | 5   | 10  | $\mu\text{A}$ |

## ■ ELECTRICAL CHARACTERISTICS2 (RF CHARACTERISTICS)

(General conditions:  $V_{CTL(H)} = 3.0\text{ V}$ ,  $V_{CTL(L)} = 0\text{ V}$ ,  $T_a = +25^\circ\text{C}$ ,  $Z_S = Z_L = 50\ \Omega$ , with application circuit)

| PARAMETERS                            | SYMBOL             | CONDITIONS             | MIN | TYP  | MAX  | UNITS |
|---------------------------------------|--------------------|------------------------|-----|------|------|-------|
| Insertion loss1                       | LOSS1              | f = 2.4 to 2.5 GHz     | -   | 0.35 | 0.55 | dB    |
| Insertion loss2                       | LOSS2              | f = 4.9 to 5.9 GHz     | -   | 0.45 | 0.70 | dB    |
| Insertion loss3                       | LOSS3              | f = 8.5 GHz            | -   | 0.60 | 0.85 | dB    |
| Isolation1                            | ISL1               | f = 2.4 to 2.5 GHz     | 25  | 28   | -    | dB    |
| Isolation2                            | ISL2               | f = 4.9 to 5.9 GHz     | 25  | 30   | -    | dB    |
| Isolation3                            | ISL3               | f = 8.5 GHz            | 16  | 20   | -    | dB    |
| Return loss1                          | RL1                | f = 2.4 to 2.5 GHz     | 18  | 28   | -    | dB    |
| Return loss2                          | RL2                | f = 4.9 to 5.9 GHz     | 15  | 20   | -    | dB    |
| Return loss3                          | RL3                | f = 8.5 GHz            | 10  | 16   | -    | dB    |
| Input power at 1dB compression point1 | P <sub>-1dB1</sub> | f = 2.4 to 2.5 GHz     | +29 | +31  | -    | dBm   |
| Input power at 1dB compression point2 | P <sub>-1dB2</sub> | f = 4.9 to 5.9 GHz     | +28 | +31  | -    | dBm   |
| Input power at 1dB compression point3 | P <sub>-1dB3</sub> | f = 8.5 GHz            | +11 | -    | -    | dBm   |
| Switching time                        | T <sub>SW</sub>    | 50% VCTL to 10%/90% RF | -   | 100  | 300  | ns    |

**■ TERMINAL INFORMATION**

| No. | SYMBOL | DESCRIPTION  |
|-----|--------|--|
| 1   | P1     | RF terminal. An external DC blocking capacitor is required.  |
| 2   | GND    | Ground terminal. Please connect this terminal with ground plane as close as possible for excellent RF performance. |
| 3   | P2     | RF terminal. An external DC blocking capacitor is required.  |
| 4   | VCTL2  | Control voltage input terminal.  |
| 5   | PC     | Common RF terminal. An external DC blocking capacitor is required.   |
| 6   | VCTL1  | Control voltage input terminal.  |

## ELECTRICAL CHARACTERISTICS

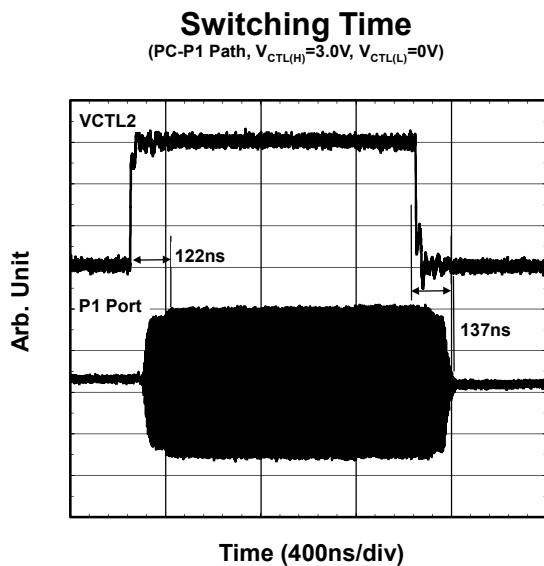
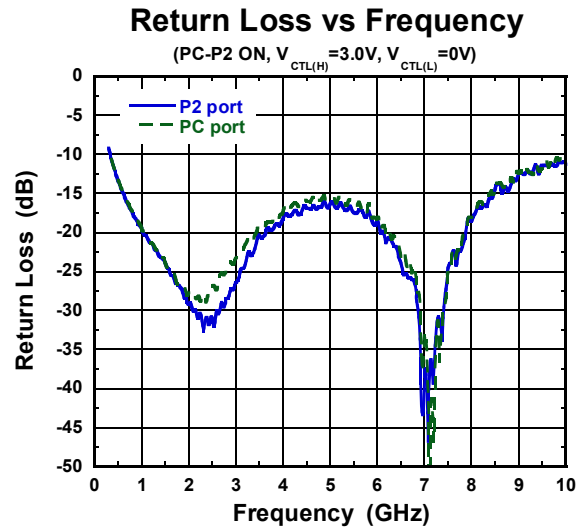
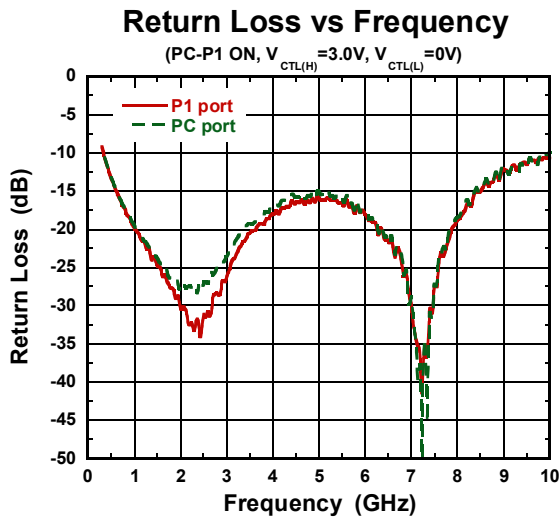
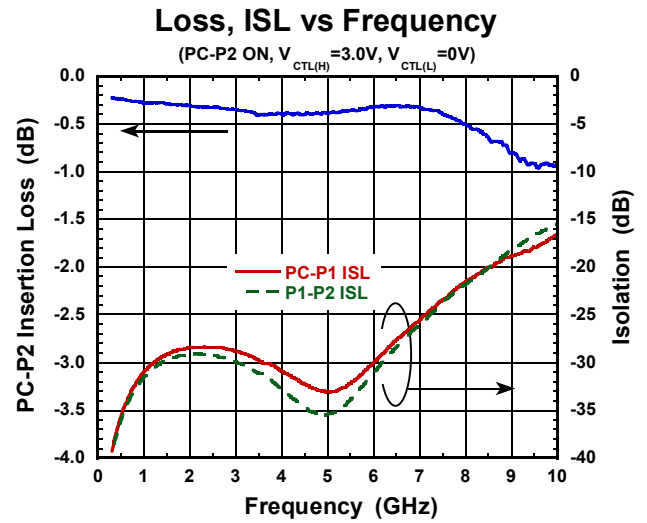
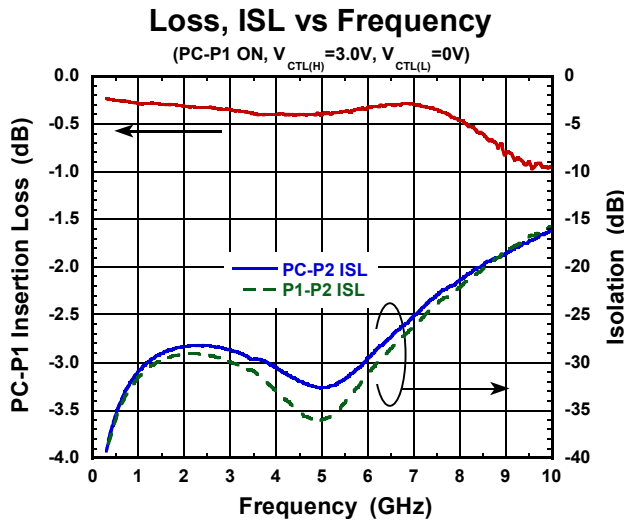

## ELECTRICAL CHARACTERISTICS

### Output Power, $I_{CTL}$ vs Input Power

(PC-P1 ON,  $V_{CTL(L)}=0V$ ,  $f=2.5GHz$ )

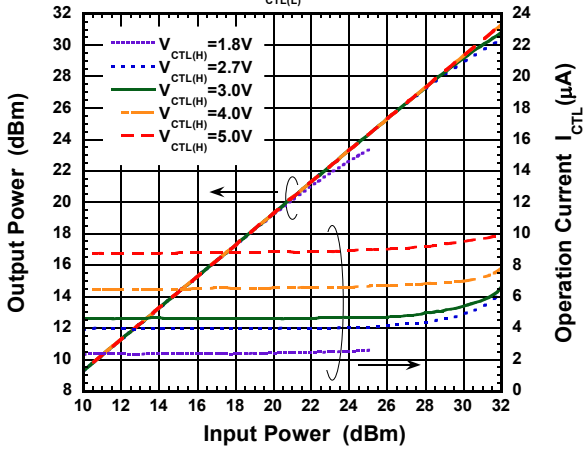

### Loss, ISL vs Input Power

(PC-P1 ON,  $V_{CTL(L)}=0V$ ,  $f=2.5GHz$ )

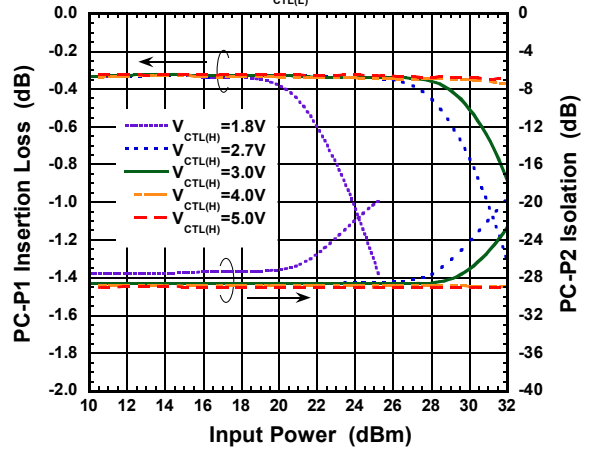

### Output Power, $I_{CTL}$ vs Input Power

(PC-P1 ON,  $V_{CTL(L)}=0V$ ,  $f=5.9GHz$ )

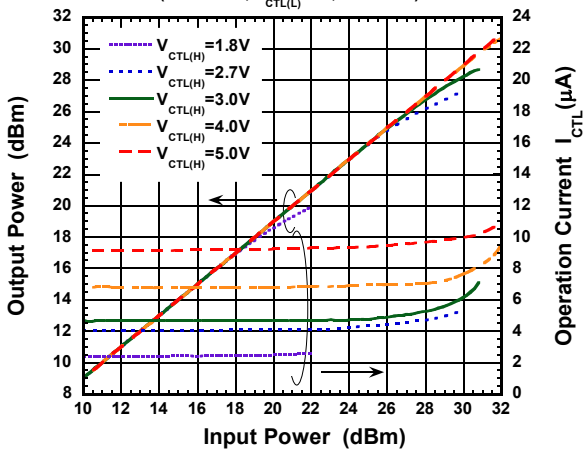

### Loss, ISL vs Input Power

(PC-P1 ON,  $V_{CTL(L)}=0V$ ,  $f=5.9GHz$ )

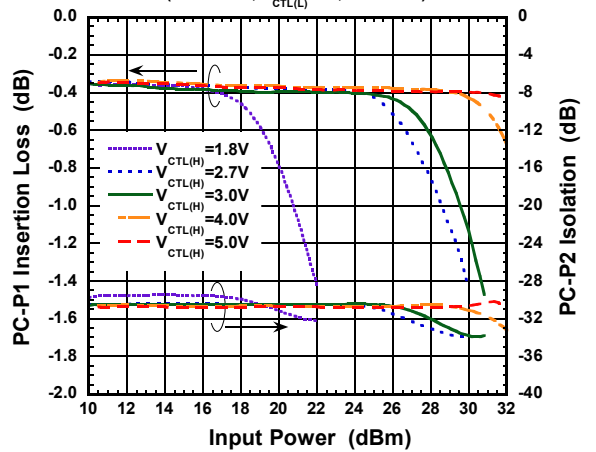

### Output Power, $I_{CTL}$ vs Input Power

(PC-P1 ON,  $V_{CTL(L)}=0V$ ,  $f=8.5GHz$ )

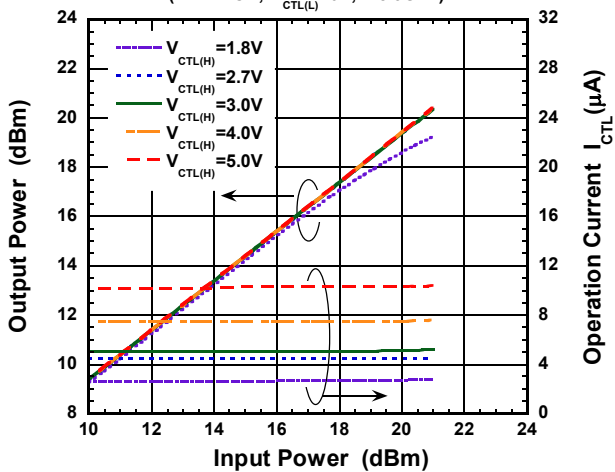

### Loss, ISL vs Input Power

(PC-P1 ON,  $V_{CTL(L)}=0V$ ,  $f=8.5GHz$ )

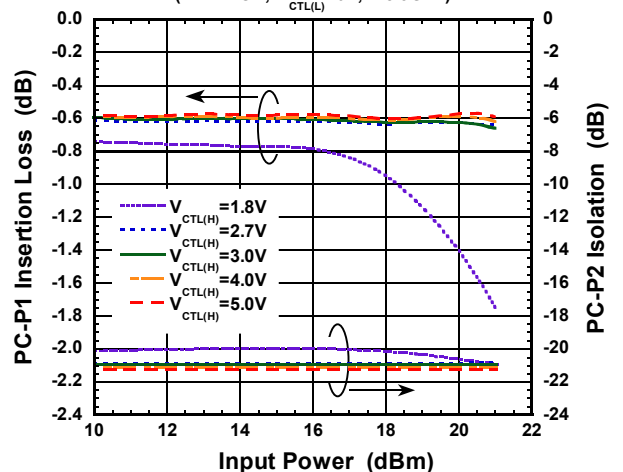

## ELECTRICAL CHARACTERISTICS

### Output Power, IM3 vs Input Power

(PC-P1 ON,  $V_{CTL(H)}=3.0V$ ,  $V_{CTL(L)}=0V$ ,  $f=2.5GHz+2.501GHz$ )

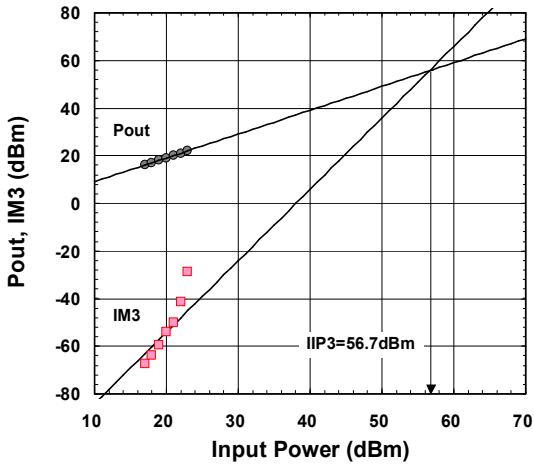

### IIP3 vs Input Power

(PC-P1 ON,  $V_{CTL(L)}=0V$ ,  $f=2.5GHz+2.501GHz$ )

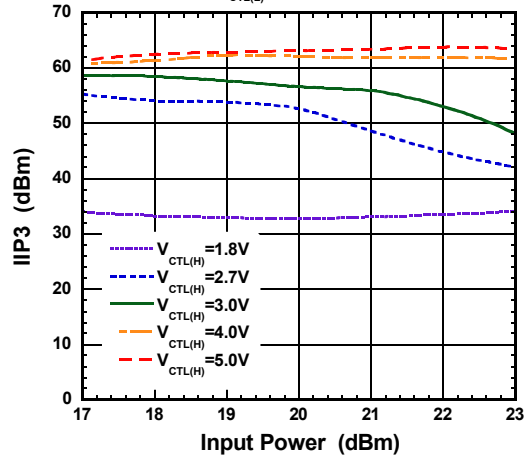

### EVM vs Input Power

(PC-P1 ON,  $V_{CTL(L)}=0V$ ,  $f=2.5GHz$ , OFDM 64QAM)

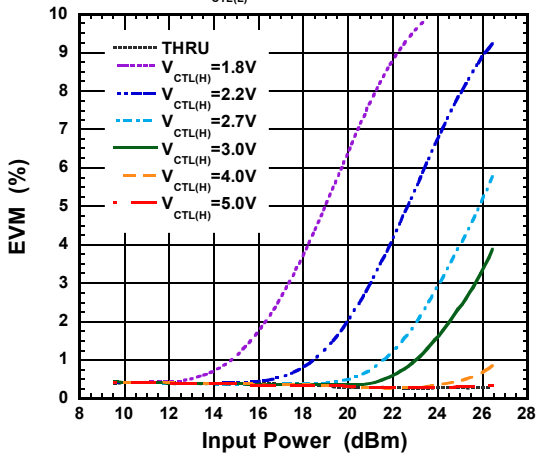

### EVM vs Input Power

(PC-P1 ON,  $V_{CTL(L)}=0V$ ,  $f=5.9GHz$ , OFDM 64QAM)

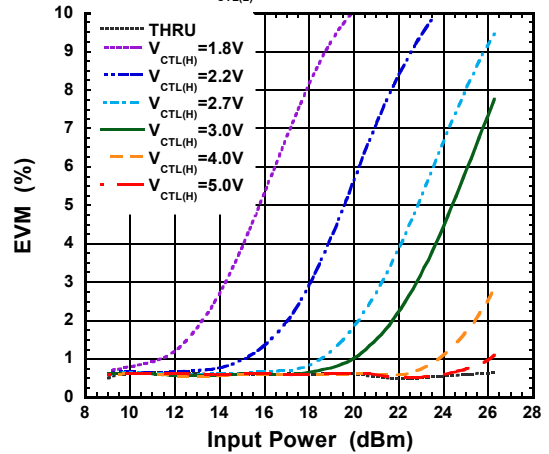

## ELECTRICAL CHARACTERISTICS

### Loss, ISL vs Temperature

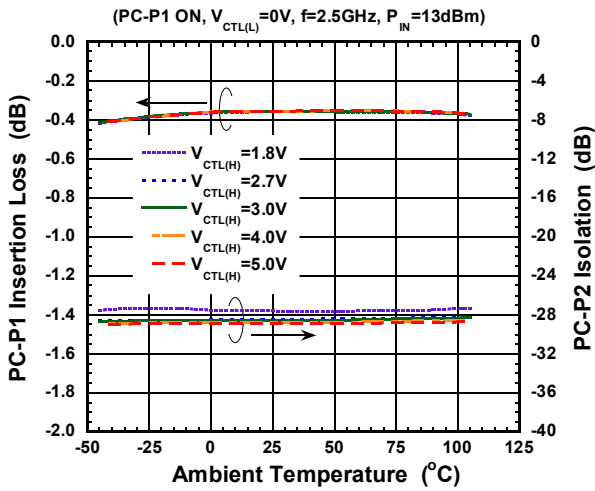

### Loss, ISL vs Temperature

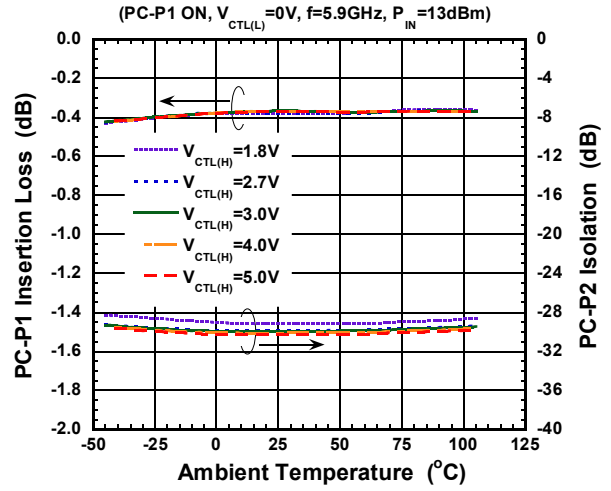

### Loss, ISL vs Temperature

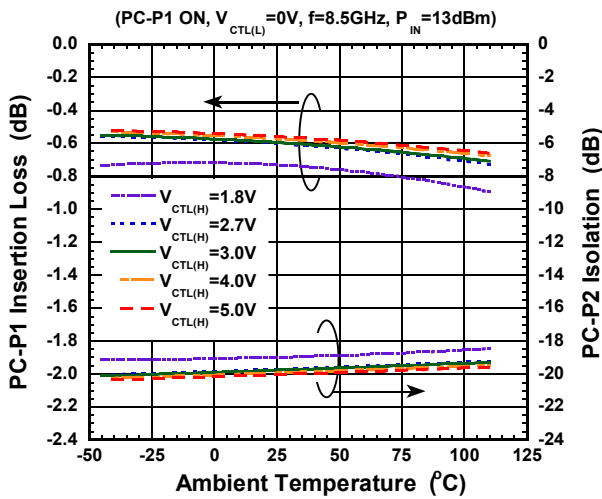

### Return Loss vs Temperature

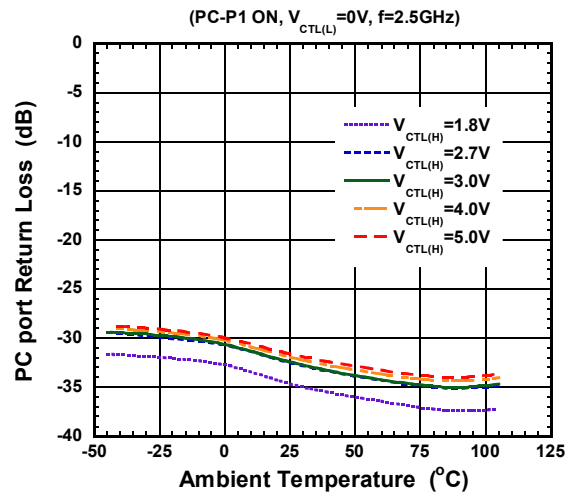

### Return Loss vs Temperature

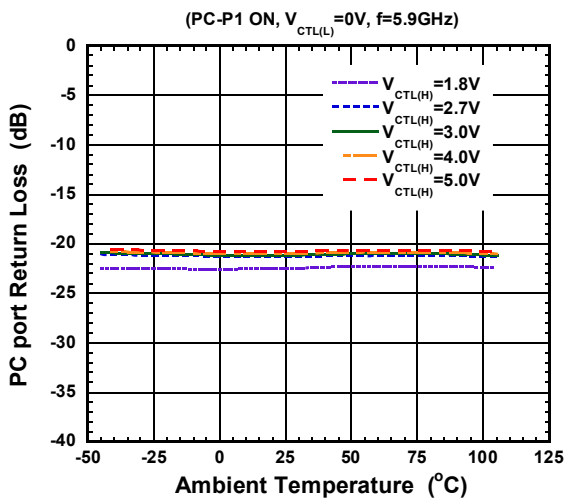

### Return Loss vs Temperature

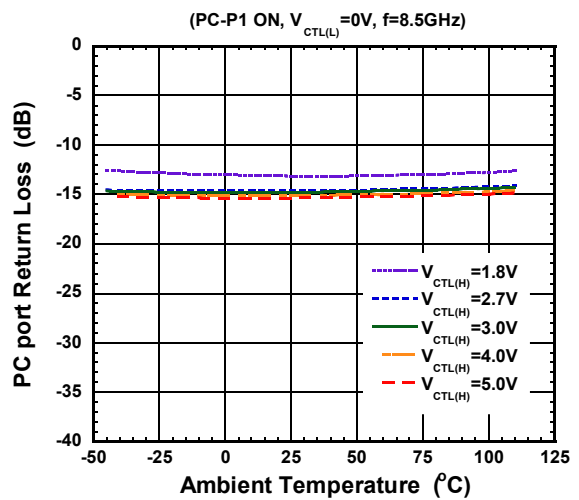



## ELECTRICAL CHARACTERISTICS

### $P_{-1dB}$ vs Temperature

(PC-P1 ON,  $V_{CTL(L)}=0V$ ,  $f=2.5GHz$ )

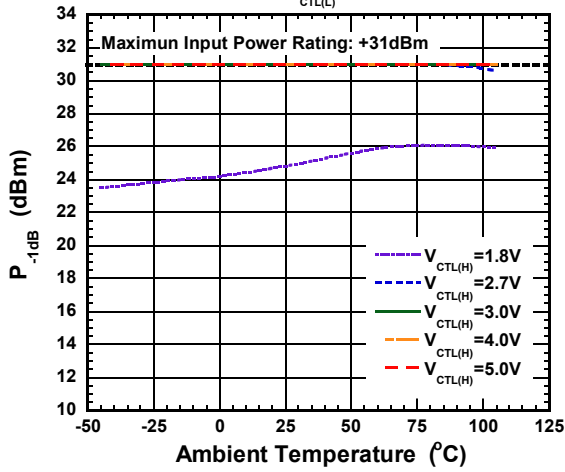

### $P_{-1dB}$ vs Temperature

(PC-P1 ON,  $V_{CTL(L)}=0V$ ,  $f=5.9GHz$ )

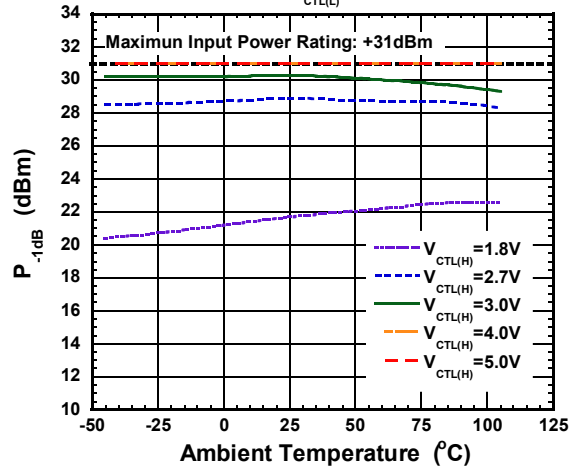

### $P_{-1dB}$ vs Temperature

(PC-P1 ON,  $V_{CTL(L)}=0V$ ,  $f=8.5GHz$ )

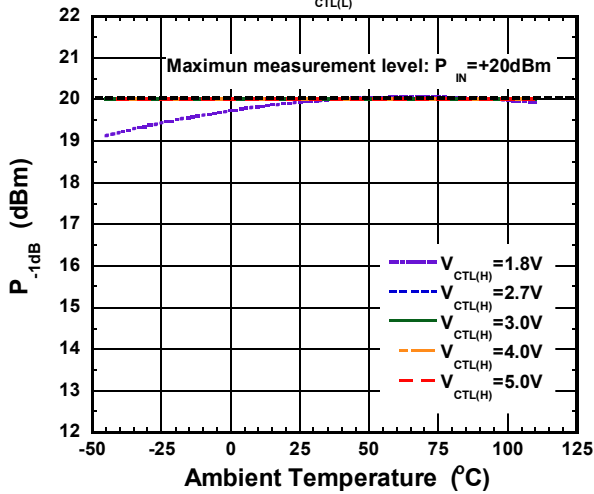

### Switching Time(rise) vs Temperature

(PC-P1 path, P1 port,  $V_{CTL(L)}=0V$ )

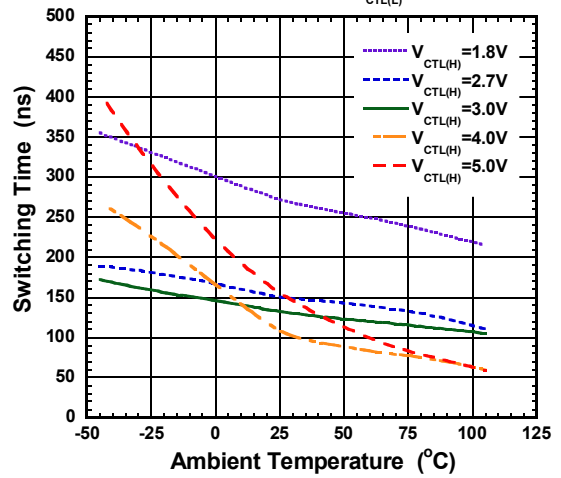

## APPLICATION CIRCUIT

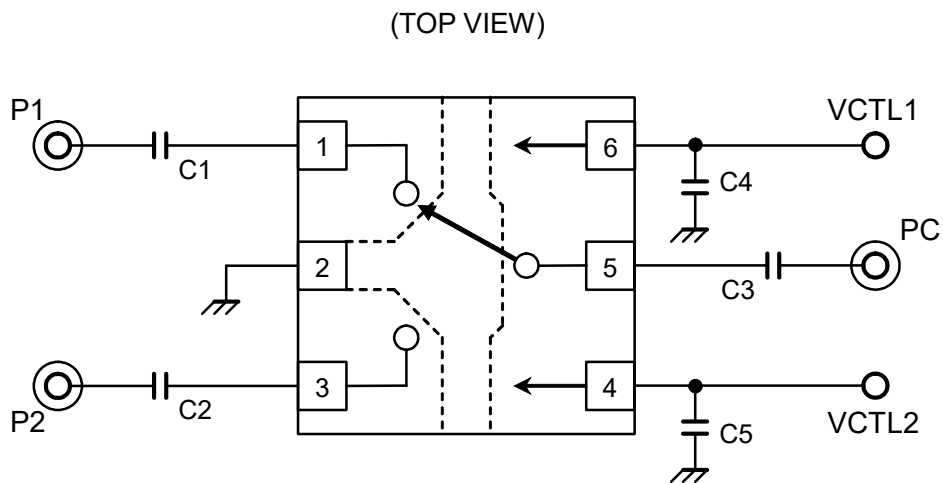

## RECOMMENDED PCB DESIGN

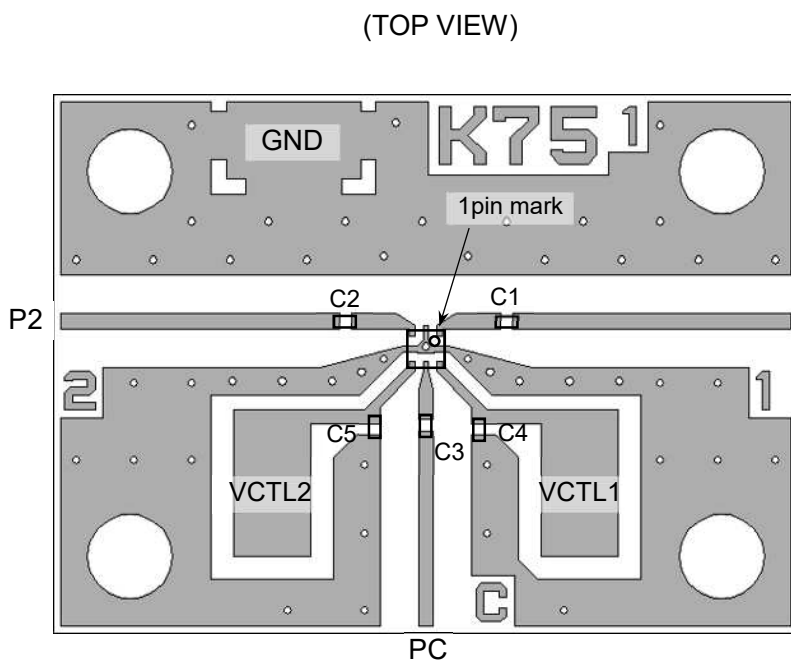

PCB: FR-4, t=0.2mm  
 Capacitor size: 0603 (0.6 x 0.3 mm)  
 Strip line width: 0.4mm  
 PCB size: 19.4 x 14.0mm  
 Through hole diameter: 0.2mm

### Loss of PCB, capacitor and connectors

| Frequency (GHz) | Loss (dB) |
|-----------------|-----------|
| 2.4             | 0.33      |
| 2.5             | 0.34      |
| 4.9             | 0.55      |
| 5.9             | 0.65      |
| 8.5             | 1.11      |

## PARTS LIST

| No.      | Value | Notes                        |
|----------|-------|------------------------------|
| C1 to C3 | 27 pF | Murata MFG<br>(GRM03 series) |
| C4 to C5 | 10 pF |                              |

## ■ PCB LAYOUT GUIDELINE

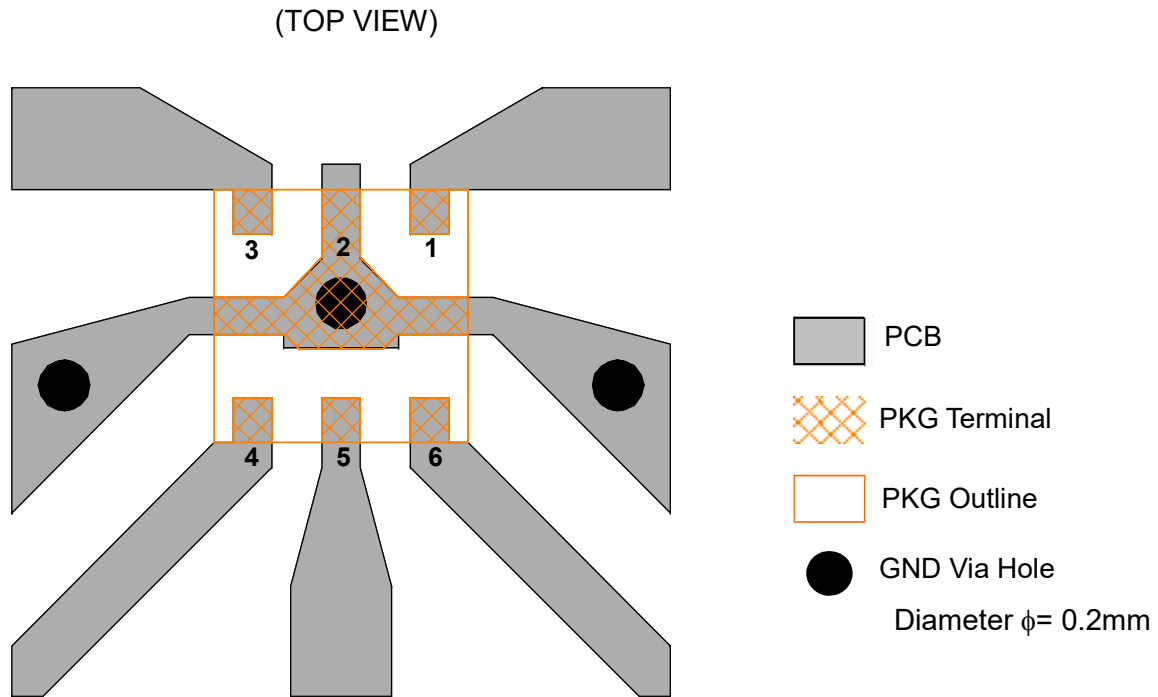

## PRECAUTIONS

- [1] The DC blocking capacitors should be placed at RF terminals. Please choose appropriate capacitance value at the application frequency.
- [2] For good RF performance, exposed pad should be connected to PCB ground plane as close as possible.

## RECOMMENDED FOOTPRINT PATTERN (6pin DFN Package 1.0x1.0mm) <Reference>

Package: 1.0mm x 1.0mm

Pin pitch: 0.35mm

 : Land

 : Mask (Open area) \*Metal mask thickness: 100μm

 : Resist (Open area)

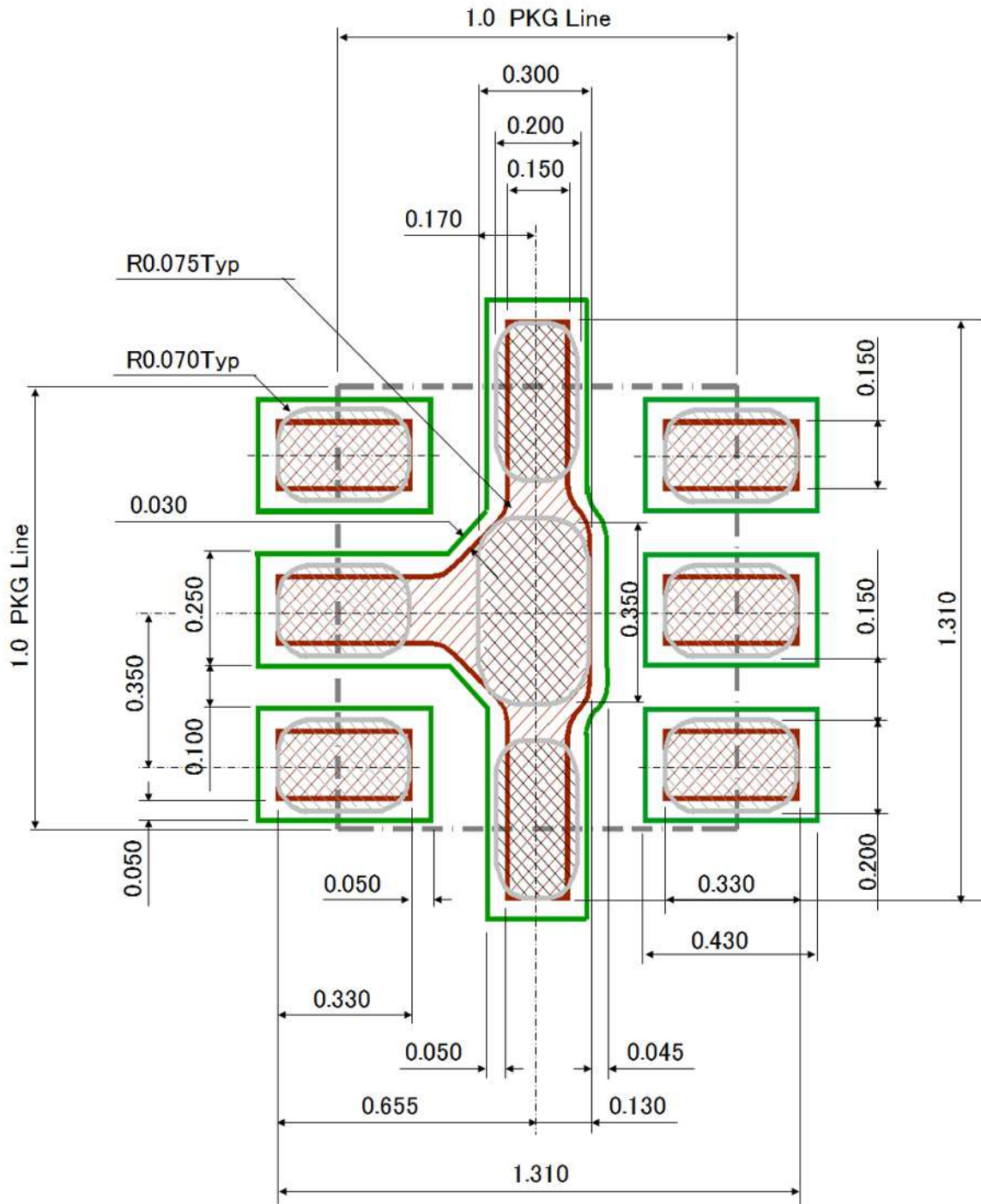

## ■ PACKAGE OUTLINE (DFN6-75)

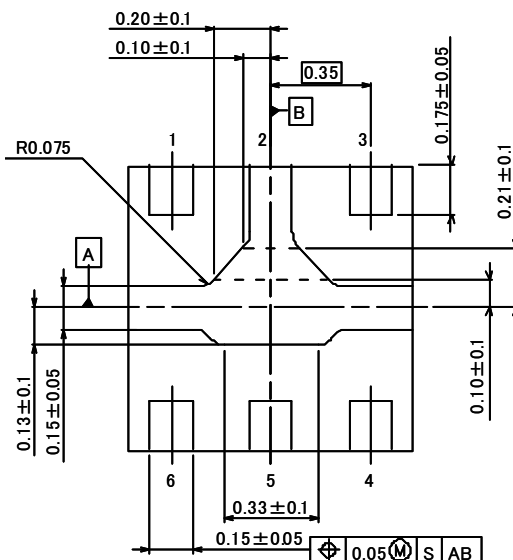
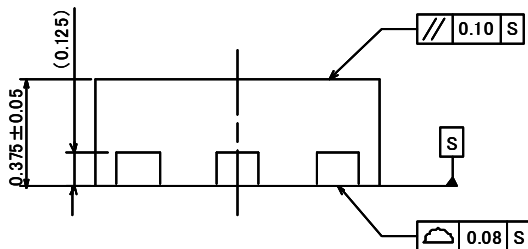
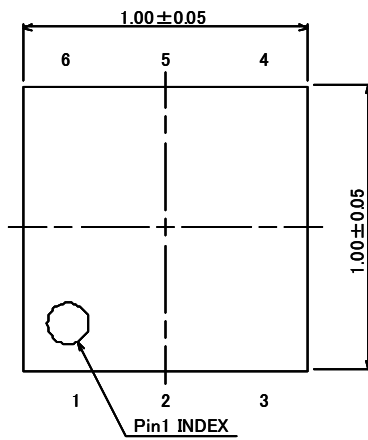

|                  |               |
|------------------|---------------|
| Unit             | : mm          |
| Board            | : Cu          |
| Terminal Treat   | : Ni/Pd/Au    |
| Molding Material | : Epoxy resin |
| Weight           | : 1.2mg       |

### Cautions on using this product

- This product contains Gallium-Arsenide (GaAs) which is a harmful material.
- Do NOT eat or put into mouth.
- Do NOT dispose in fire or break up this product.
- Do NOT chemically make gas or powder with this product.
- To waste this product, please obey the relating law of your country.

### [CAUTION]

The specifications on this databook are only given for information, without any guarantee as regards either mistakes or omissions. The application circuits in this databook are described only to show representative usages of the product and not intended for the guarantee or permission of any right including the industrial rights.

This product may be damaged with electric static discharge (ESD) or spike voltage. Please handle with care to avoid these damages.

1. The products and the product specifications described in this document are subject to change or discontinuation of production without notice for reasons such as improvement. Therefore, before deciding to use the products, please refer to our sales representatives for the latest information thereon.
2. The materials in this document may not be copied or otherwise reproduced in whole or in part without the prior written consent of us.
3. This product and any technical information relating thereto are subject to complementary export controls (so-called KNOW controls) under the Foreign Exchange and Foreign Trade Law, and related politics ministerial ordinance of the law. (Note that the complementary export controls are inapplicable to any application-specific products, except rockets and pilotless aircraft, that are insusceptible to design or program changes.) Accordingly, when exporting or carrying abroad this product, follow the Foreign Exchange and Foreign Trade Control Law and its related regulations with respect to the complementary export controls.
4. The technical information described in this document shows typical characteristics and example application circuits for the products. The release of such information is not to be construed as a warranty of or a grant of license under our or any third party's intellectual property rights or any other rights.
5. The products listed in this document are intended and designed for use as general electronic components in standard applications (office equipment, telecommunication equipment, measuring instruments, consumer electronic products, amusement equipment etc.). Those customers intending to use a product in an application requiring extreme quality and reliability, for example, in a highly specific application where the failure or misoperation of the product could result in human injury or death should first contact us.
  - Aerospace Equipment
  - Equipment Used in the Deep Sea
  - Power Generator Control Equipment (nuclear, steam, hydraulic, etc.)
  - Life Maintenance Medical Equipment
  - Fire Alarms / Intruder Detectors
  - Vehicle Control Equipment (automotive, airplane, railroad, ship, etc.)
  - Various Safety Devices
  - Traffic control system
  - Combustion equipment

In case your company desires to use this product for any applications other than general electronic equipment mentioned above, make sure to contact our company in advance. Note that the important requirements mentioned in this section are not applicable to cases where operation requirements such as application conditions are confirmed by our company in writing after consultation with your company.

6. We are making our continuous effort to improve the quality and reliability of our products, but semiconductor products are likely to fail with certain probability. In order to prevent any injury to persons or damages to property resulting from such failure, customers should be careful enough to incorporate safety measures in their design, such as redundancy feature, fire containment feature and fail-safe feature. We do not assume any liability or responsibility for any loss or damage arising from misuse or inappropriate use of the products.
7. The products have been designed and tested to function within controlled environmental conditions. Do not use products under conditions that deviate from methods or applications specified in this datasheet. Failure to employ the products in the proper applications can lead to deterioration, destruction or failure of the products. We shall not be responsible for any bodily injury, fires or accident, property damage or any consequential damages resulting from misuse or misapplication of the products.
8. **Quality Warranty**
  - 8-1. **Quality Warranty Period**

In the case of a product purchased through an authorized distributor or directly from us, the warranty period for this product shall be one (1) year after delivery to your company. For defective products that occurred during this period, we will take the quality warranty measures described in section 8-2. However, if there is an agreement on the warranty period in the basic transaction agreement, quality assurance agreement, delivery specifications, etc., it shall be followed.
  - 8-2. **Quality Warranty Remedies**

When it has been proved defective due to manufacturing factors as a result of defect analysis by us, we will either deliver a substitute for the defective product or refund the purchase price of the defective product.

Note that such delivery or refund is sole and exclusive remedies to your company for the defective product.
  - 8-3. **Remedies after Quality Warranty Period**

With respect to any defect of this product found after the quality warranty period, the defect will be analyzed by us. On the basis of the defect analysis results, the scope and amounts of damage shall be determined by mutual agreement of both parties. Then we will deal with upper limit in Section 8-2. This provision is not intended to limit any legal rights of your company.
9. Anti-radiation design is not implemented in the products described in this document.
10. The X-ray exposure can influence functions and characteristics of the products. Confirm the product functions and characteristics in the evaluation stage.
11. WLCSP products should be used in light shielded environments. The light exposure can influence functions and characteristics of the products under operation or storage.
12. Warning for handling Gallium and Arsenic (GaAs) products (Applying to GaAs MMIC, Photo Reflector). These products use Gallium (Ga) and Arsenic (As) which are specified as poisonous chemicals by law. For the prevention of a hazard, do not burn, destroy, or process chemically to make them as gas or power. When the product is disposed of, please follow the related regulation and do not mix this with general industrial waste or household waste.
13. Please contact our sales representatives should you have any questions or comments concerning the products or the technical information.



**Nisshinbo Micro Devices Inc.**

**Official website**

<https://www.nisshinbo-microdevices.co.jp/en/>

**Purchase information**

<https://www.nisshinbo-microdevices.co.jp/en/buy/>