

## 40 A 600 V 150 °C junction temperature SCR in TO-220AB package

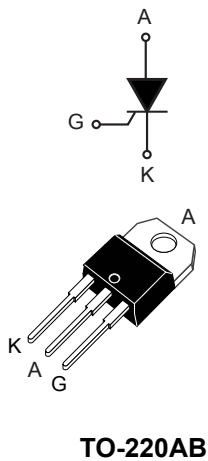

### Features

- High junction temperature :  $T_j = 150\text{ °C}$
- High noise immunity  $dV/dt = 500\text{ V}/\mu\text{s}$  up to  $150\text{ °C}$
- Gate triggering current  $I_{GT} = 15\text{ mA}$
- Off-state voltage  $600\text{ V } V_{DRM}/V_{RRM}$
- High turn on current rise  $dI/dt = 100\text{ A}/\mu\text{s}$
- **ECOPACK2** compliant component

### Applications

- Motorbike voltage regulator circuits
- Inrush current limiting circuit
- Motor control circuits and starters
- Solid state relays

### Description

The TN4015H-6T in non-isolated TO-220AB package offers high thermal performances up to 40 A, thanks to its junction temperature up to  $150\text{ °C}$ .

Its trade-off noise immunity ( $dV/dt = 500\text{ V}/\mu\text{s}$ ) versus its gate triggering current ( $I_{GT} = 15\text{ mA}$ ) and its turn-on current rise ( $dI/dt = 100\text{ A}/\mu\text{s}$ ) allows to design robust and compact control circuit for voltage regulator in motorbikes and industrial drives, overvoltage crowbar protection, motor control circuits in power tools and kitchen aids, inrush current limiting circuits.

#### Product status link

[TN4015H-6T](#)

#### Product summary

$I_{T(RMS)}$	40 A
$V_{DRM}/V_{RRM}$	600 V
$V_{DSM}/V_{RSM}$	800 V
$I_{GT}$	15 mA
Package	TO-220AB

# 1 TN4015H-6T\_Characteristics

**Table 1. Absolute maximum ratings (limiting values),  $T_j = 25\text{ °C}$  unless otherwise specified**

Symbol	Parameter	Value	Unit
$I_{T(RMS)}$	RMS on-state current (180 ° conduction angle)	$T_c = 119\text{ °C}$ 40	A
$I_{T(AV)}$	Average on-state current (180 ° conduction angle)	$T_c = 120\text{ °C}$ 25	A
		$T_c = 125\text{ °C}$ 22	
		$T_c = 128\text{ °C}$ 20	
$I_{TSM}$	Non repetitive surge peak on-state current	$t_p = 8.3\text{ ms}$ 394	A
		$t_p = 10\text{ ms}$ 360	
$I^2t$	$I^2t$ value for fusing	$t_p = 10\text{ ms}$ 648	$A^2s$
$di/dt$	Critical rate of rise of on-state current $I_G = 2 \times I_{GT}$ , $t_r \leq 100\text{ ns}$	$f = 60\text{ Hz}$ 100	$A/\mu s$
$V_{DRM}/V_{RRM}$	Repetitive peak off-state voltage	$T_j = 150\text{ °C}$ 600	V
$V_{DSM}/V_{RSM}$	Non repetitive surge peak off-state voltage	$t_p = 10\text{ ms}$ 800	V
$I_{GM}$	Peak gate current	$t_p = 20\text{ }\mu s$ $T_j = 150\text{ °C}$ 4	A
$P_{G(AV)}$	Average gate power dissipation	$T_j = 150\text{ °C}$ 1	W
$V_{RGM}$	Maximum peak reverse gate voltage	5	V
$T_{stg}$	Storage junction temperature range	-40 to +150	$^{\circ}C$
$T_j$	Maximum operating junction temperature	-40 to +150	$^{\circ}C$
$T_L$	Maximum lead temperature soldering during 10 s	260	$^{\circ}C$

**Table 2. Electrical characteristics ( $T_j = 25\text{ °C}$  unless otherwise specified)**

Symbol	Test Conditions	Value	Unit	
$I_{GT}$	$V_D = 12\text{ V}$ , $R_L = 33\text{ }\Omega$	Max.	15	mA
$V_{GT}$		Max.	1.3	V
$V_{GD}$	$V_D = V_{DRM}$ , $R_L = 3.3\text{ k}\Omega$	$T_j = 150\text{ °C}$ Min.	0.15	V
$I_H$	$I_T = 500\text{ mA}$ , gate open	Max.	60	mA
$I_L$	$I_G = 1.2 \times I_{GT}$	Max.	80	mA
$dV/dt$	$V_D = 402\text{ V}$ , gate open	$T_j = 150\text{ °C}$ Min.	500	$V/\mu s$
$t_{gt}$	$I_T = 80\text{ A}$ , $V_D = 600\text{ V}$ , $I_G = 100\text{ mA}$ , $(dI_G/dt)_{max} = 0.2\text{ A}/\mu s$	Typ.	1.9	$\mu s$
$t_q$	$V_D = 402\text{ V}$ , $I_T = 40\text{ A}$ , $V_R = 25\text{ V}$ , $dV_D/dt = 50\text{ V}/\mu s$ , $(dI_G/dt)_{max} = 30\text{ A}/\mu s$	$T_j = 150\text{ °C}$ Typ.	85	$\mu s$

**Table 3. Static characteristics**

Symbol	Test conditions			Value	Unit
$V_{TM}$	$I_{TM} = 80 \text{ A}$ , $t_p = 380 \mu\text{s}$	$T_j = 25 \text{ }^\circ\text{C}$	Max.	1.6	V
$V_{TO}$	Threshold voltage	$T_j = 150 \text{ }^\circ\text{C}$	Max.	0.85	
$R_D$	Dynamic resistance	$T_j = 150 \text{ }^\circ\text{C}$	Max.	10	m $\Omega$
$I_{DRM}$ , $I_{RRM}$	$V_D = V_{DRM} = V_{RRM}$	$T_j = 25 \text{ }^\circ\text{C}$	Max.	10	$\mu\text{A}$
		$T_j = 150 \text{ }^\circ\text{C}$		6	mA

**Table 4. Thermal parameters**

Symbol	Parameter	Value	Unit
$R_{th(j-c)}$	Junction to case (DC)	Max.	0.8
$R_{th(j-a)}$	Junction to ambient (DC)	Typ.	60

## 1.1 Characteristics curves

**Figure 1. Maximum average power dissipation versus average on-state current**

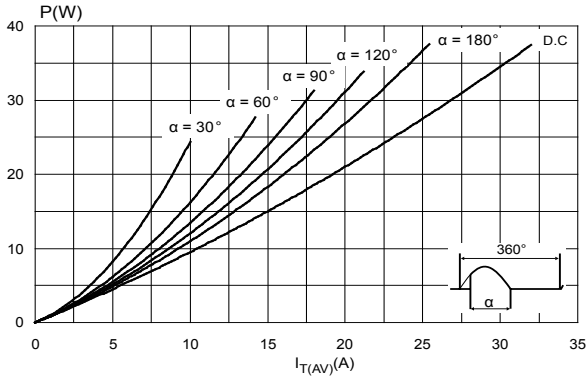

**Figure 2. Average and DC on-state current versus case temperature**

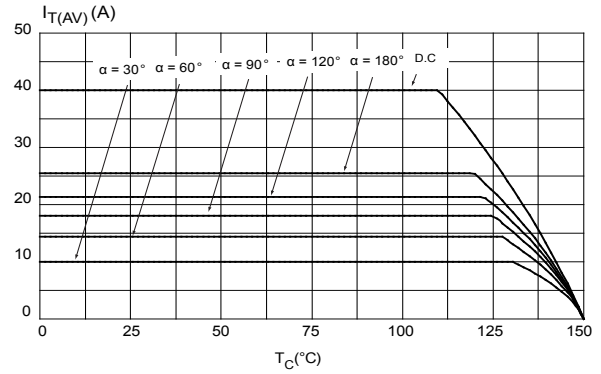

**Figure 3. Average and D.C. on state current versus ambient temperature**

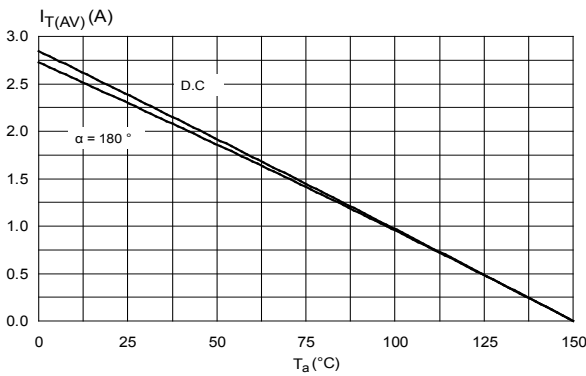

**Figure 4. Relative variation of thermal impedance versus pulse duration**

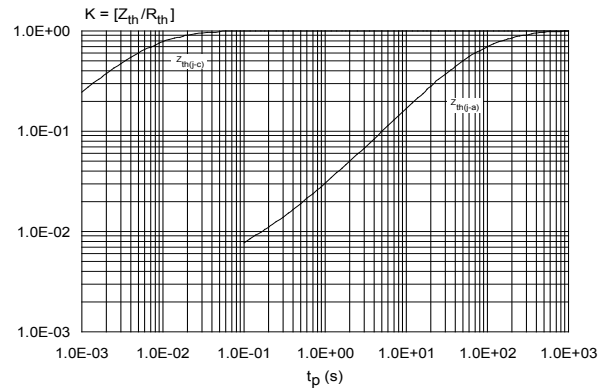

**Figure 5. Relative variation of gate trigger current and gate voltage versus junction temperature (typical values)**

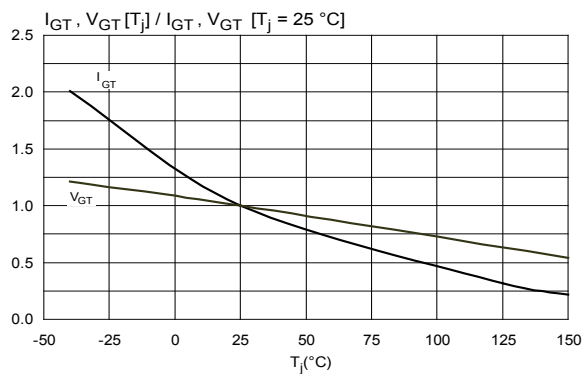

**Figure 6. Relative variation of holding and latching current versus junction temperature (typical values)**

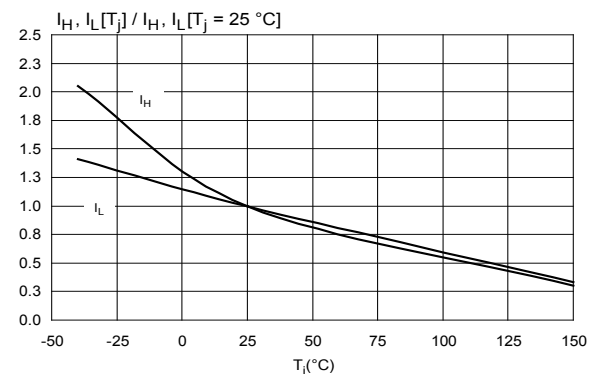

**Figure 7. Relative variation of static dV/dt immunity versus junction temperature**

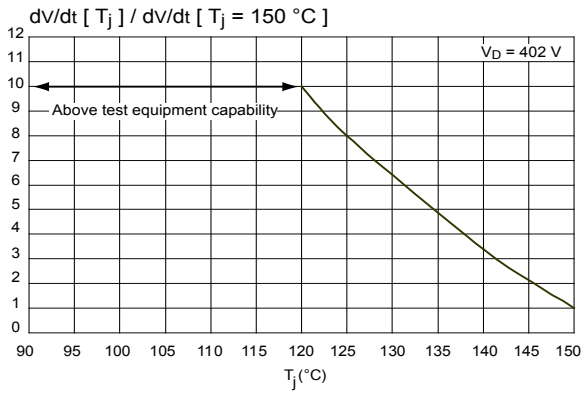

**Figure 8. Surge peak on-state current versus number of cycles**

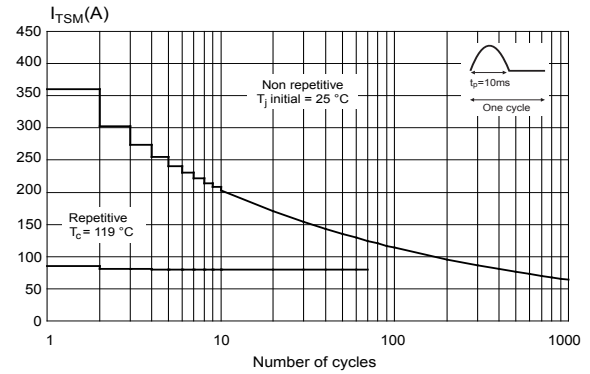

**Figure 9. Non repetitive surge peak on-state current for a sinusoidal pulse with width tp < 10 ms**

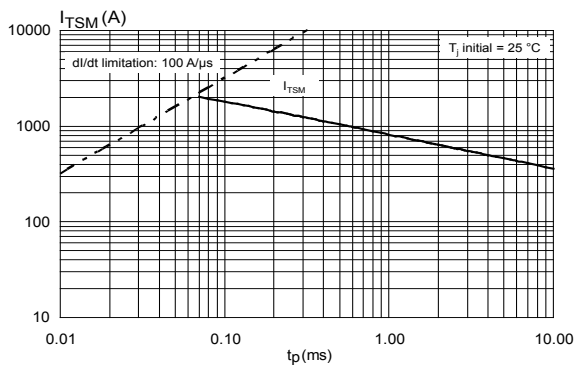

**Figure 10. On-state characteristics (maximum values)**

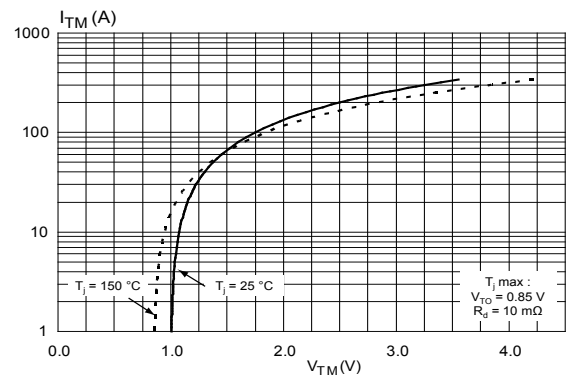

**Figure 11. Relative variation of leakage current versus junction temperature**

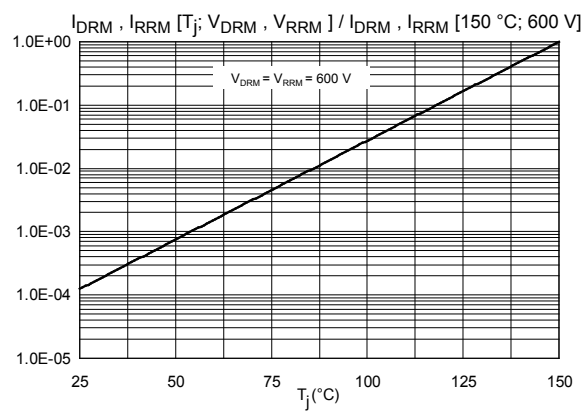

## 2 Package information

In order to meet environmental requirements, ST offers these devices in different grades of **ECOPACK** packages, depending on their level of environmental compliance. ECOPACK specifications, grade definitions and product status are available at: [www.st.com](http://www.st.com). ECOPACK is an ST trademark.

### 2.1 TO-220AB package information

- Molding compound resin is halogen free and meets UL94 flammability standard, level V0
- Lead-free plating package leads
- Recommended torque: 0.4 to 0.6 N·m

Figure 12. TO-220AB package outline

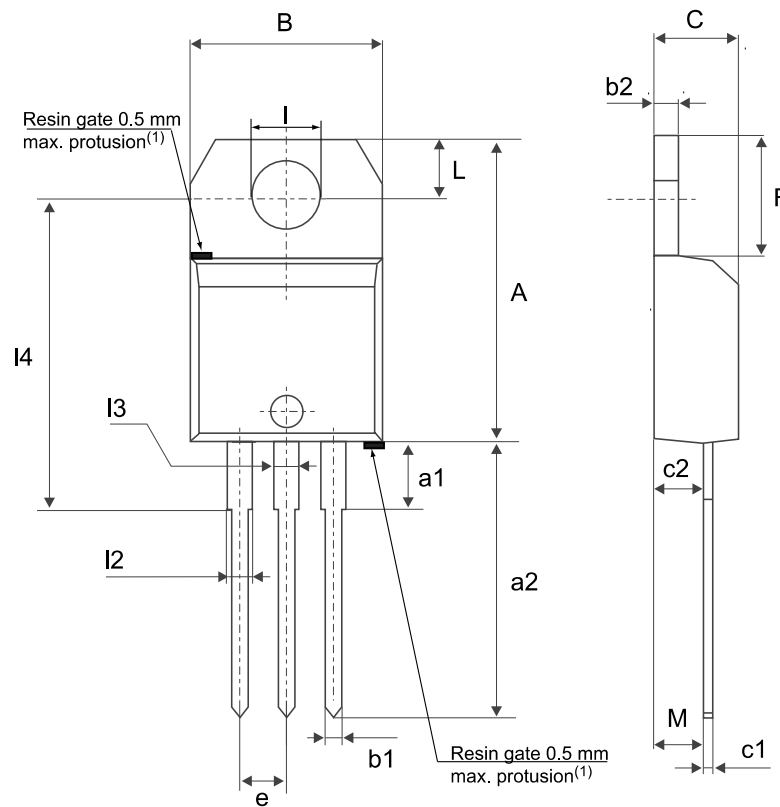

(1) Resin gate position accepted in one of the two positions or in the symmetrical opposites.

**Table 5. TO-220AB package mechanical data**

Ref.	Dimensions					
	Millimeters			Inches <sup>(1)</sup>		
	Min.	Typ.	Max.	Min.	Typ.	Max.
A	15.20		15.90	0.5984		0.6260
a1		3.75			0.1476	
a2	13.00		14.00	0.5118		0.5512
B	10.00		10.40	0.3937		0.4094
b1	0.61		0.88	0.0240		0.0346
b2	1.23		1.32	0.0484		0.0520
C	4.40		4.60	0.1732		0.1811
c1	0.49		0.70	0.0193		0.0276
c2	2.40		2.72	0.0945		0.1071
e	2.40		2.70	0.0945		0.1063
F	6.20		6.60	0.2441		0.2598
I	3.73		3.88	0.1469		0.1528
L	2.65		2.95	0.1043		0.1161
I2	1.14		1.70	0.0449		0.0669
I3	1.14		1.70	0.0449		0.0669
I4	15.80	16.40	16.80	0.6220	0.6457	0.6614
M		2.6			0.1024	

1. Inch dimensions are for reference only.

### 3 Ordering information

Figure 13. Ordering information scheme

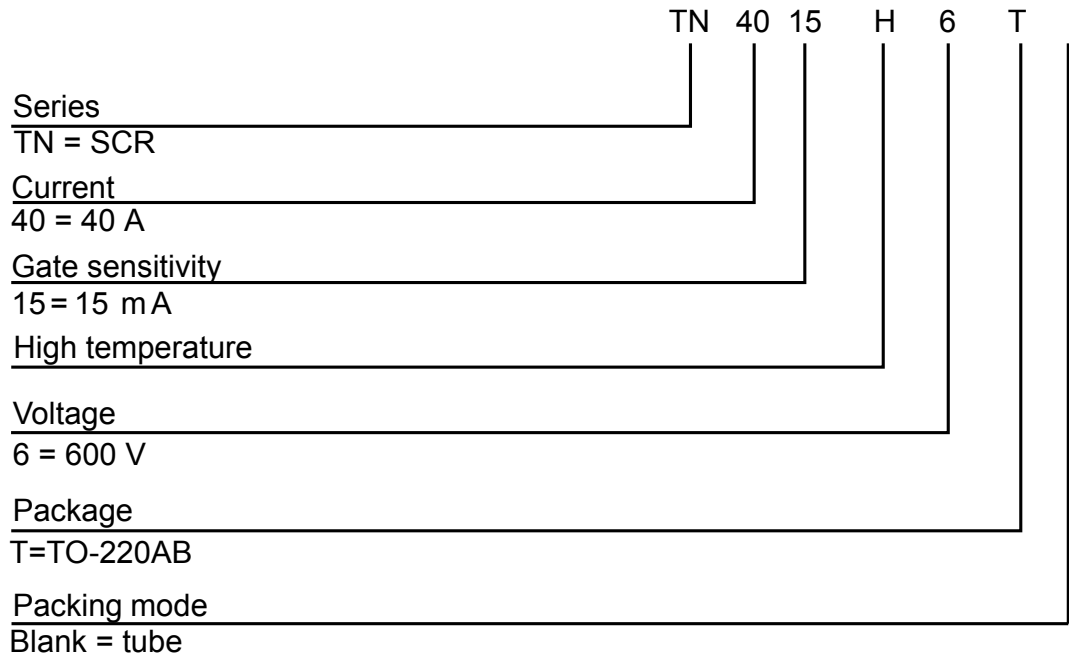

Table 6. Ordering information

Order code	Marking	Package	Weight	Base qty.	Delivery mode
TN4015H-6T	TN4015H6	TO-220AB	2.3 g	50	Tube



## Revision history

**Table 7. Document revision history**

Date	Revision	Changes
03-Aug-2016	1	Initial release.
10-Dec-2021	2	Updated <a href="#">Table 1</a> .
25-Nov-2022	3	Updated <a href="#">Section</a> cover image.

**IMPORTANT NOTICE – READ CAREFULLY**

STMicroelectronics NV and its subsidiaries (“ST”) reserve the right to make changes, corrections, enhancements, modifications, and improvements to ST products and/or to this document at any time without notice. Purchasers should obtain the latest relevant information on ST products before placing orders. ST products are sold pursuant to ST’s terms and conditions of sale in place at the time of order acknowledgment.

Purchasers are solely responsible for the choice, selection, and use of ST products and ST assumes no liability for application assistance or the design of purchasers’ products.

No license, express or implied, to any intellectual property right is granted by ST herein.

Resale of ST products with provisions different from the information set forth herein shall void any warranty granted by ST for such product.

ST and the ST logo are trademarks of ST. For additional information about ST trademarks, refer to [www.st.com/trademarks](http://www.st.com/trademarks). All other product or service names are the property of their respective owners.

Information in this document supersedes and replaces information previously supplied in any prior versions of this document.

© 2022 STMicroelectronics – All rights reserved