

# Data sheet

Order No.: 1156863

Type: FQ 1,27D/ 30-PV- 160-1-BR

SMD pin header, Reflow soldering

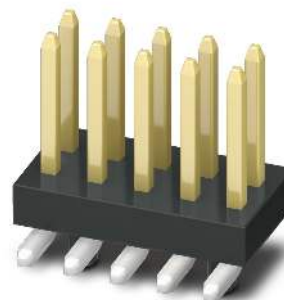

The figure shows the 10-pos. version

## 1 Main features



- |                |              |                        |                 |
|----------------|--------------|------------------------|-----------------|
| • No. of pos.  | 30           | • Nominal current      | 1 A             |
| • Test voltage | 500 V AC     | • Mounting type        | SMD soldering   |
| • Color        | black (9005) | • Connection direction | 90 °            |
| • Pitch        | 1.27 mm      | • Type of packaging    | 32 mm wide tape |

## 2 Your advantages

- ✓ Reliable mechanical and electrical connections thanks to the double-sided contact system
- ✓ Designed for integration into the SMT soldering process
- ✓ Clear and cost-optimized design
- ✓ Suitable for a multitude of applications



Make sure you always use the latest documentation.

It can be downloaded at: [phoenixcontact.net/product/1156863](https://phoenixcontact.net/product/1156863)

**3 Table of contents**

1	Main features.....	1
2	Your advantages .....	1
3	Table of contents .....	2
4	3D model in PDF can be activated (Acrobat Reader only).....	3
5	General Technical Data .....	4
6	Mounting.....	5
7	Dimensions.....	6
8	Series drawing.....	7
9	Product notes .....	8
10	Packaging information .....	8
11	Blister drawing.....	9
12	Application.....	10
13	General tests .....	11
14	Mechanical tests.....	12
15	Electrical tests .....	13
16	Current carrying capacity/derating curves .....	14
17	Commercial Data.....	15
18	Combination tests.....	16

1156863 FQ 1,27D/ 30-PV- 160-1-BR

4 3D model in PDF can be activated (Acrobat Reader only)

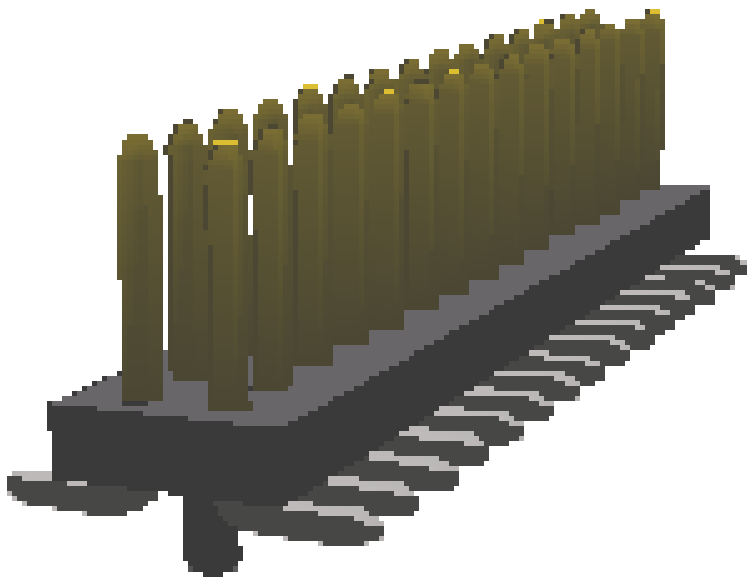

**1156863 FQ 1,27D/ 30-PV- 160-1-BR****5 General Technical Data****5.1 item properties**

Order No.	1156863
Type	FQ 1,27D/ 30-PV- 160-1-BR
Connector system	FINEPITCH FQ 1,27
Product type	SMD pin header
Type of contact	Male connector
Range of articles	FQ 1,27D/...-PV
Pitch	1.27 mm
Number of positions	30
Number of levels	2
Type of locking	without
Mounting type	SMD soldering
Connection direction of the connector to the PCB	90 °
Pin layout	Linear pad geometry

**1156863 FQ 1,27D/ 30-PV- 160-1-BR****6 Mounting****6.1 Flange mounting**

Type of locking	without
-----------------	---------

**6.2 Material of metal parts**

Note	WEEE/RoHS-compliant, whisker-free acc. to IEC 60068-2-82/JEDEC JESD 201
Contact material	Cu alloy
Surface contact area	Nickel (Ni) , Gold (Au)
Soldering area surface	Tin (Sn)
Surface characteristics	Selective coating
<b>Insulating material data</b>	<b>Housing</b>
Color	black (9005)
Insulating material	PA
Insulating material group	I
CTI according to IEC 60112	600
Flammability rating according to UL 94	V0

**1156863 FQ 1,27D/ 30-PV- 160-1-BR****7 Dimensions****7.1 Dimensions for the product**

Length	5.5 mm
Width	19.05 mm
Total height	6 mm
Installed height	5.1 mm
Coplanarity	≤ 0.1 mm

**7.2 Dimensions for the application**

Contact cover	0.4 mm
Overlap length	1.3 mm
Stacking height	6.2 mm Tolerance: +1.3 mm (in combination with Range of articles:FQ 1,27D/...-SV)

1156863 FQ 1,27D/ 30-PV- 160-1-BR

8 Series drawing

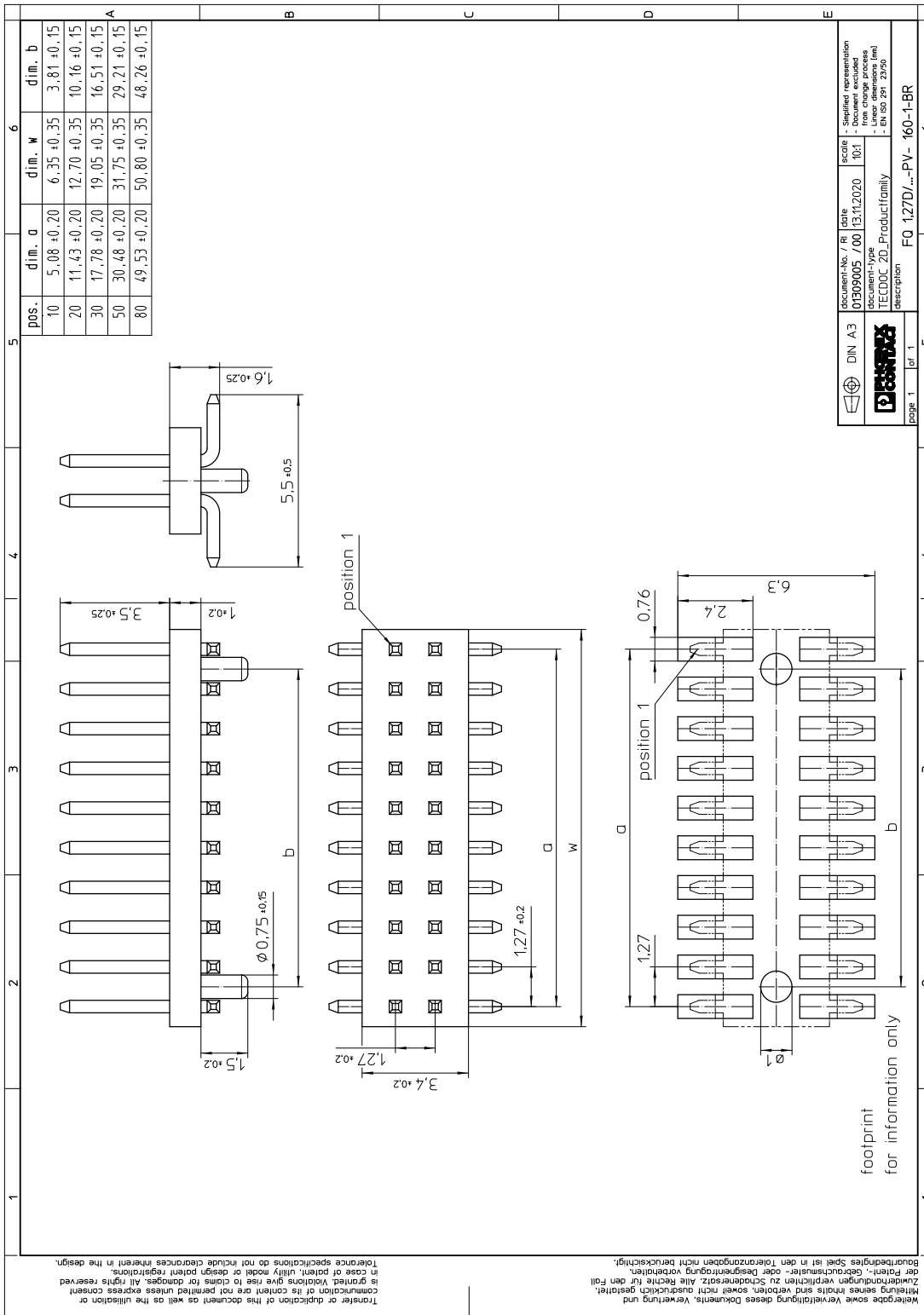

**1156863 FQ 1,27D/ 30-PV- 160-1-BR****9 Product notes****9.1 General information**

Notes on operation

The permissible voltage during operation depends on the application, taking into consideration the air clearances and creepage distances within the scope of insulation requirements in accordance with IEC 60664-1.

**10 Packaging information**

Type of packaging	32 mm wide tape
Pieces per package	700
Outer packaging type	Transparent-Bag
ESD level	(D) electrostatically conductive
Specification	DIN EN 61340-5-1 (VDE 0300-5-1): 2008-07
[W] tape width	32 mm
[A] coil diameter	330 mm
[W2] coil overall dimension	38.4 mm
Number of products per coil	700

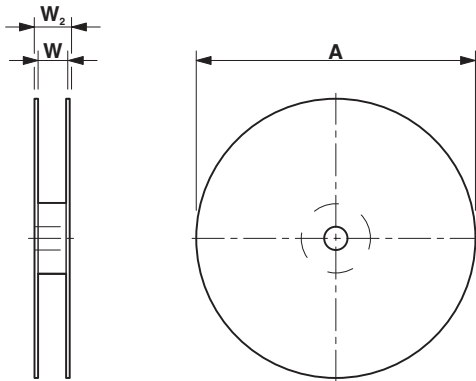



1156863 FQ 1,27D/ 30-PV- 160-1-BR

11 Blister drawing

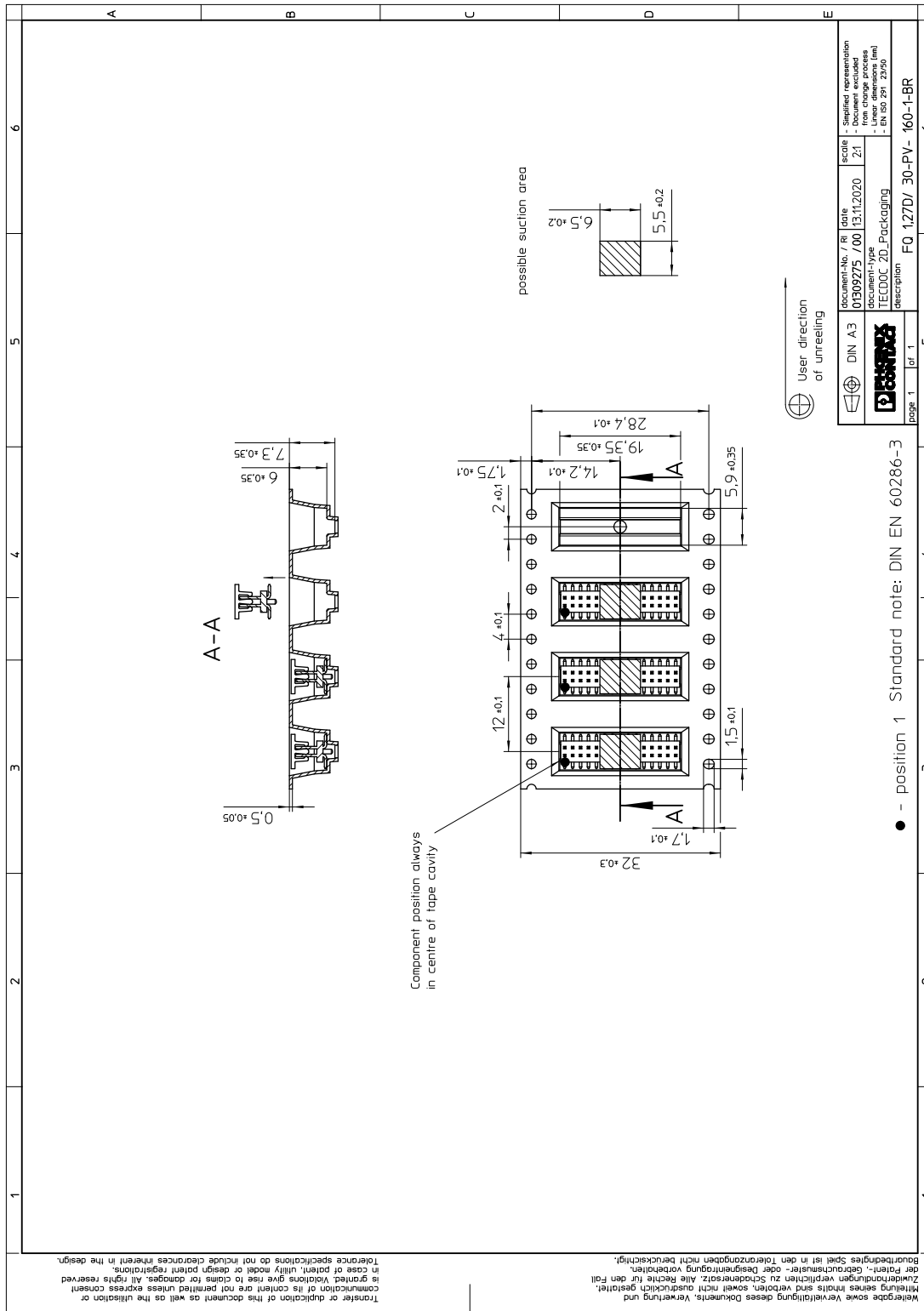

## 12 Application

### 12.1 Temperature limit values

Ambient temperature (storage/transport)	-40 °C ... 70 °C
Ambient temperature (assembly)	-5 °C ... 100 °C
Ambient temperature (operation)	-40 °C ... 125 °C

## 1156863 FQ 1,27D/ 30-PV- 160-1-BR

---

### 13 General tests

#### 13.1 Specification

Brief description

Board-to-board connectors

## 14 Mechanical tests

### 14.1 Insertion and withdrawal force per contact

Insertion and withdrawal force per contact	
	≤ 1.2 N
Specification	
	IEC 60512-9-1:2010-03 (following)
	100 Insertion/withdrawal cycles

**1156863 FQ 1,27D/ 30-PV- 160-1-BR****15 Electrical tests**

Nominal current at 20 °C	1 A IEC 60512-5-2:2002-02 (80-pos.)
Test voltage	500 V AC IEC 60512-4-1:2003

**15.1 Air and creepage distances**

Minimum value for clearance and creepage distance	0.25 mm
---	---------

**1156863 FQ 1,27D/ 30-PV- 160-1-BR****16 Current carrying capacity/derating curves**

Specification	IEC 60512-5-2:2002-02
Note	max. 1 A at 20°C (80-pos.)
Reduction factor	0.8

**Type: FQ 1,27D/...-SV- 490-1-BR with FQ 1,27D/...-PV- 160-1-BR**

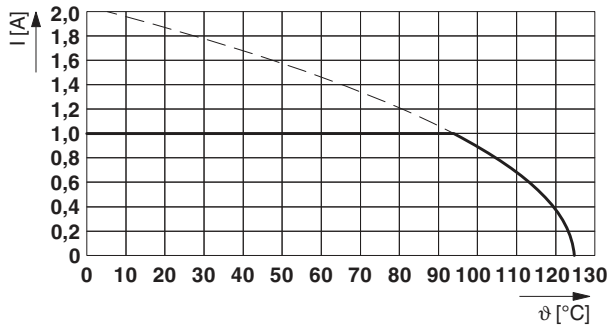
**16.1 Insulation resistance**

Insulation resistance	> 1 G $\Omega$ , (IEC 60512-3-1:2002-02)
-----------------------	--

**16.2 forward resistance**

Contact resistance	$\leq 30$ m $\Omega$ , (IEC 60512-2-1:2002-02)
--------------------	--

**16.3 Vibration test**

Specification	IEC 60068-2-6:2007-12
Result	Test passed
Frequency	10 - 55 - 10 Hz
Sweep speed	1 octave/min
Amplitude	1.52 mm
Acceleration	181 m/s <sup>2</sup>
Test duration per axis	2 h
Test directions	X-, Y- and Z-axis
Note	

**1156863 FQ 1,27D/ 30-PV- 160-1-BR****17 Commercial Data**

Order No.	1156863
Type	FQ 1,27D/ 30-PV- 160-1-BR
Pieces per package	700
Net weight	2.22 g
GTIN	4063151160531
	Information that applies locally, see link on page 1

## 1156863 FQ 1,27D/ 30-PV- 160-1-BR

## 18 Combination tests

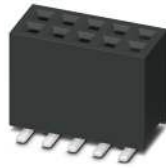
**FQ 1,27D/...-PV****FQ 1,27D/...-SV****Mechanical tests**

Insertion/withdrawal force per position

approx. 1.2 N / 1.2 N

**Durability tests**Contact resistance  $R_1$ 20 m $\Omega$ 

Insertion/withdrawal cycles

100

Contact resistance  $R_2$ 30 m $\Omega$ 

Test voltage

500 V AC

Insulation resistance  
Requirements > 5 M $\Omega$ > 1 G $\Omega$ **Thermal tests**

Tested number of positions

80

Test current

1 A