

HLPT-B5x0-00000

Silicon NPN Phototransistor

Description

The Broadcom[®] HLPT-B5x0-00000 is a robust and efficient phototransistor in an industry-standard 5-mm through-hole lamp package.

This product comes with black epoxy which filters off undesired visible light.

The product is available in multiple angles of half sensitivity. It has a wide spectral range of sensitivity of 700 nm to 1100 nm, and coupled with its high photo-sensitivity, this product is a suitable candidate for a variety of applications in consumer and industrial segments such as office automation, light curtains, machine controls, and smoke detectors.

This product is easy to use and a cost-effective solution which offers superior performance.

Features

- 5-mm radial package
- Black epoxy package
- High photo-sensitivity
- Available in multiple angles of half sensitivity

Applications

- Office automation
- Light curtains
- Machine controls

Figure 1: Package Drawing

For Angle of Sensitivity $\pm 10^\circ$ and $\pm 25^\circ$

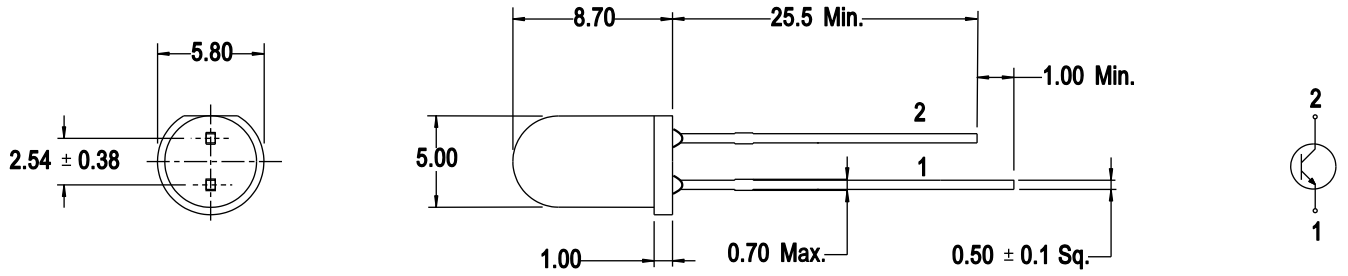

For Angle of Sensitivity $\pm 40^\circ$

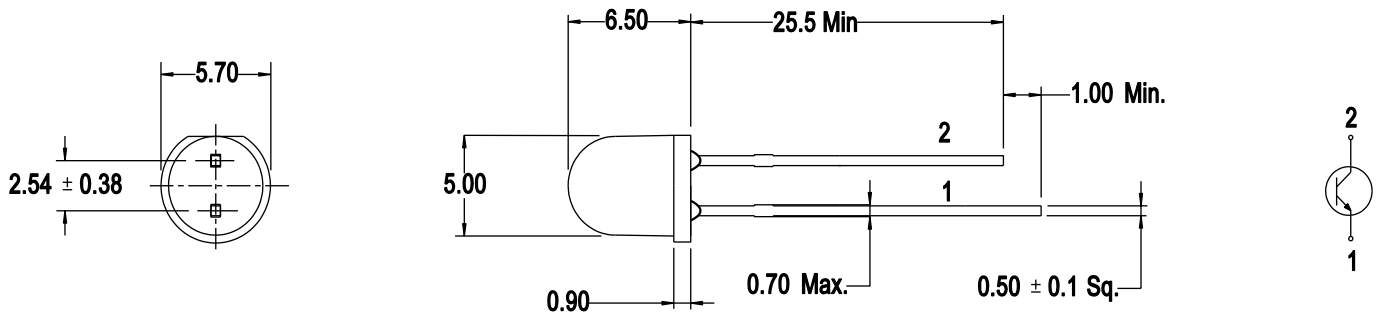

NOTE:

1. All dimensions are in millimeters (mm).
2. Tolerance is ± 0.25 mm unless otherwise specified.
3. Lead spacing is measured at the location where the leads emerge from the body.
4. The epoxy meniscus may extend up to a maximum of 1.00 mm down the leads.

Device Selection Guide ($T_J = 25^\circ\text{C}$)

Part Number	Collector Light Current, I_{ca} (mA) @ $E_e = 0.5 \text{ mW/cm}^2$, $\lambda = 940 \text{ nm}$, $V_{CE} = 5\text{V}$			Angle of Half Sensitivity, ϕ
	Min.	Typ.	Max.	Typ.
HLPT-B5D0-00000	5.0	8.0	12.5	± 10
HLPT-B5G0-00000	1.6	3.0	4.0	± 25
HLPT-B5K0-00000	1.0	1.6	2.5	± 40

Absolute Maximum Ratings

Parameter	Symbol	Rating	Unit
Collector-Emitter Voltage	V_{CEO}	30	V
Emitter-Collector Voltage	V_{ECO}	5	V
Collector Current	I_C	30	mA
Power Dissipation	P_d	150	mW
Operating Temperature Range	—	-40 to +85	$^\circ\text{C}$
Storage Temperature Range	—	-40 to +100	$^\circ\text{C}$

Optical and Electrical Characteristics ($T_J = 25^\circ\text{C}$)

Parameter	Symbol	Min.	Typ.	Max.	Units	Test Conditions
Spectral Range of Sensitivity	$\lambda_{0.1}$	700	—	1100	nm	—
Wavelength of Peak Sensitivity	λ_{max}	—	830	—	nm	—
Dark Current	I_{CEO}	—	—	100	nA	$V_{CE} = 20\text{V}$, $E_e = 0 \text{ mW/cm}^2$
Collector-Emitter Saturation Voltage	$V_{CE\text{sat}}$	—	—	0.40	V	$I_{CA} = 0.1 \text{ mA}$, $E_e = 0.5 \text{ mW/cm}^2$, $\lambda = 940 \text{ nm}$
Collector-Emitter Capacitance	C_{CEO}	—	6.5	—	pF	$V_{CE} = 0\text{V}$, $f = 1 \text{ MHz}$, $E_e = 0 \text{ mW/cm}^2$

Figure 2: Relative Sensitivity vs. Wavelength

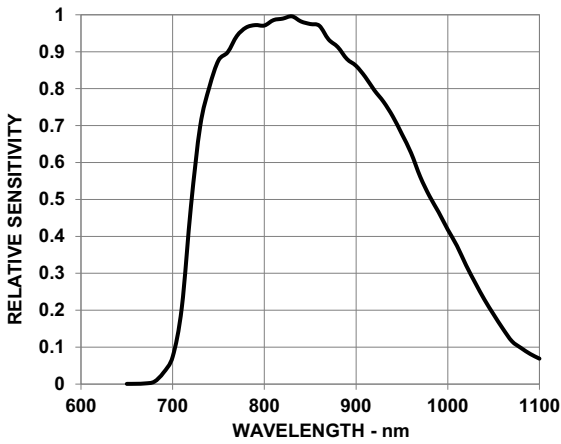

Figure 3: Relative Sensitivity vs. Angular Displacement

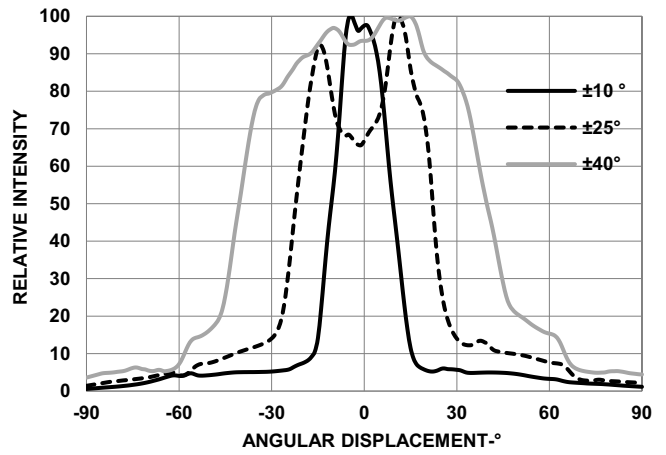

Figure 4: Relative Collector Current vs. Irradiance

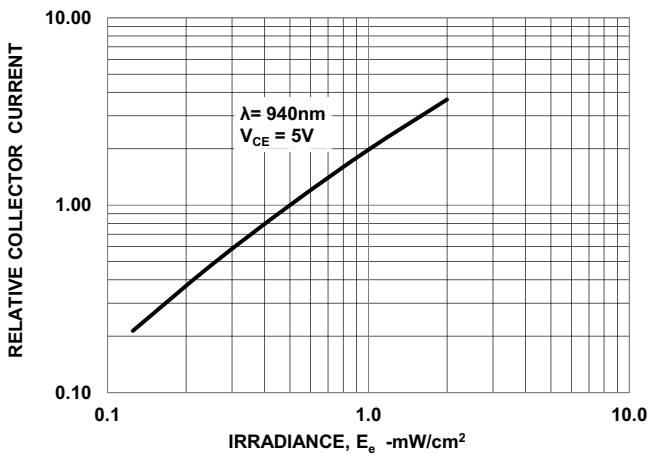

Figure 5: Collector Current vs. Collector Emitter Voltage for HLPT-B5D0

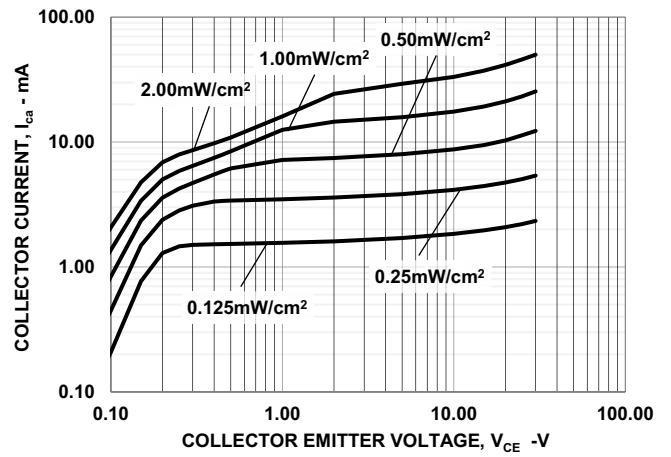

Figure 6: Collector Current vs. Collector Emitter Voltage for HLPT-B5G0

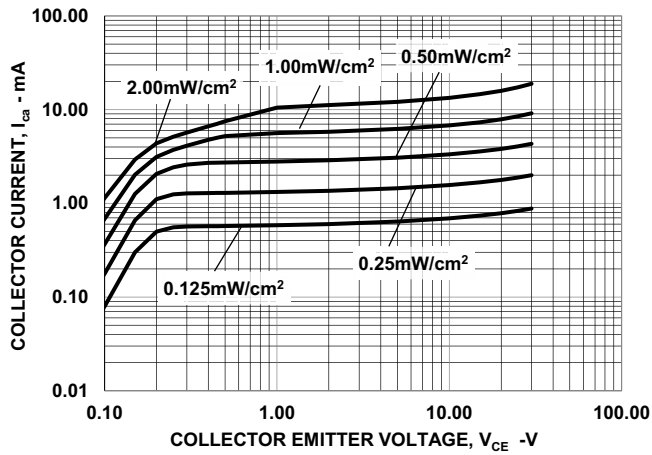

Figure 7: Collector Current vs. Collector Emitter Voltage for HLPT-B5K0

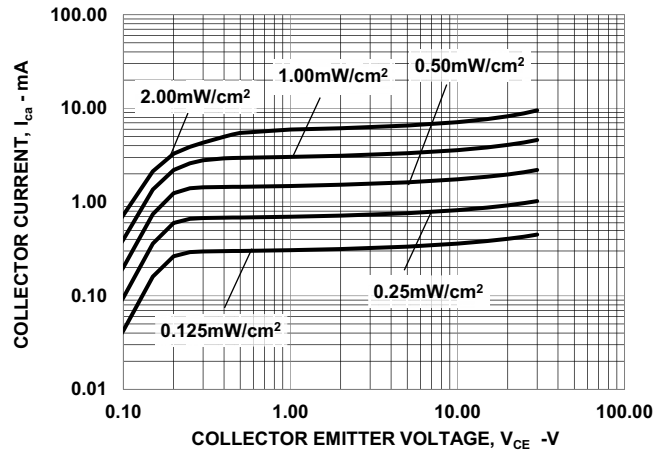

Figure 8: Relative Collector Current vs. Ambient Temperature

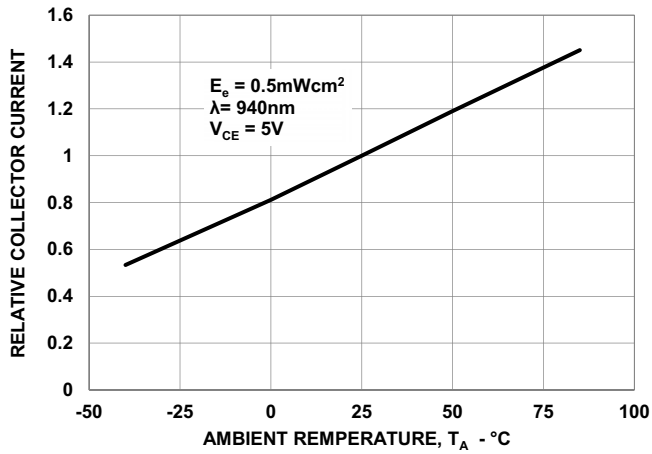

Figure 9: Dark Current vs. Ambient Temperature

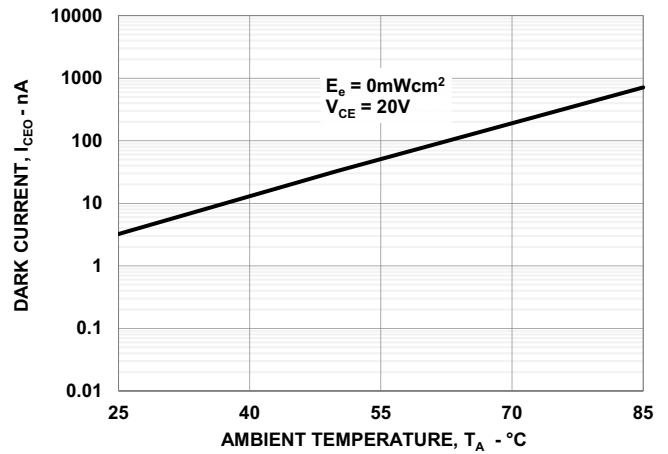

Figure 10: Collector-Emitter Capacitance vs. Collector-Emitter Voltage

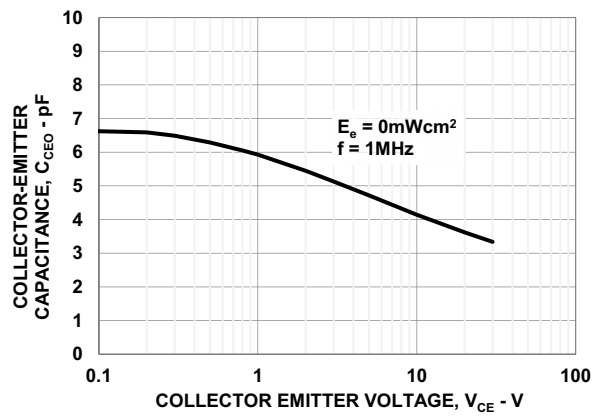
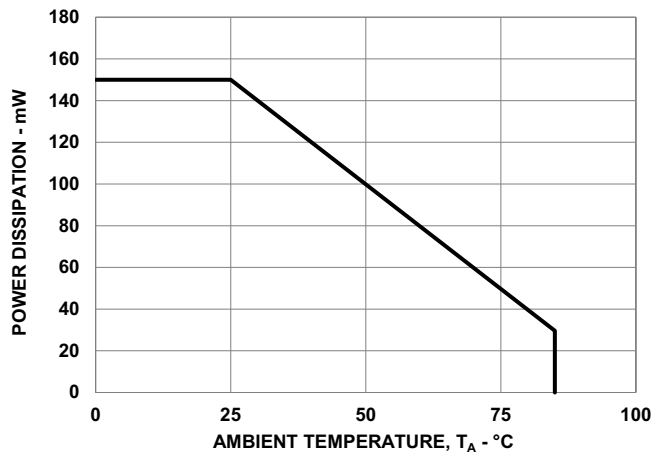

Figure 11: Power Dissipation vs. Ambient Temperature



Precautionary Notes

Soldering and Handling Precautions

- Set and maintain the wave soldering parameters according to the recommended temperature and dwell time. Perform a daily check on the profile to ensure that it always conforms to the recommended conditions. Exceeding these conditions will over-stress the package and cause premature failures.
- Use only bottom preheaters to reduce the thermal stress experienced by the package.
- Recalibrate the soldering profile before loading a new type of PCB. PCBs with different sizes and designs (component density) will have a different heat capacity and might cause a change in temperature experienced by the PCB if the same wave soldering setting is used.
- Do not perform wave soldering more than once.
- Any alignment fixture used during wave soldering must be loosely fitted and must not apply stress on the package. Use non-metal material because it will absorb less heat during the wave soldering process.
- At elevated temperatures, the package is more susceptible to mechanical stress. Allow the package to be sufficiently cooled to room temperature before handling. Do not apply stress to the package when it is hot.
- Use wave soldering to solder the package. Use hand soldering only for rework or touch up if unavoidable, but it must be strictly controlled to following conditions:
 - Soldering iron tip temperature = 315°C maximum
 - Soldering duration = 2 seconds maximum
 - Number of cycles = 1 only
 - Power of soldering iron = 50W maximum
- Do not touch the package body with the soldering iron except for the soldering terminals because it may cause damage to the package.
- Confirm beforehand whether the functionality and performance of the package is affected by soldering with hand soldering.
- Keep the heat source at least 1.6 mm away from the package body during soldering.
- Design the appropriate hole size to avoid problems during insertion or clinching (for auto-insertable devices).

Figure 12: Recommended PCB Through Hole Size

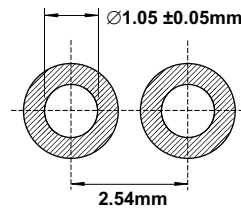
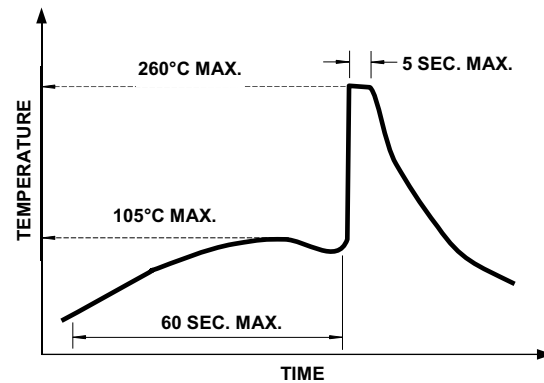

Figure 13: Recommended Wave Soldering Profile



NOTE: Refers to measurements with thermocouple mounted at the bottom of the PCB.

Lead Forming

- To pre-form or cut the leads prior to insertion and soldering onto PCB, use the proper tool instead of doing it manually.
- Do not bend the leads at the location less than 3 mm from the package body.
- Do not use the base of the package body as a fulcrum for lead bending. Secure the leads properly before bending.
- If manual lead cutting is unavoidable, cut the leads after soldering to reduce stress to the package body.

Application Precautions

- Avoid rapid changes in the ambient temperature, especially in high-humidity environments, because they cause condensation on the package.
- If the package is intended to be used in a harsh or an outdoor environment, protect the package against damages caused by rain water, water, dust, oil, corrosive gases, external mechanical stresses, and so on.

Disclaimer

Broadcom's products and software are not specifically designed, manufactured, or authorized for sale as parts, components, or assemblies for the planning, construction, maintenance, or direct operation of a nuclear facility or for use in medical devices or applications. The customer is solely responsible, and waives all rights to make claims against Broadcom or its suppliers, for all loss, damage, expense, or liability in connection with such use.

Copyright © 2022 Broadcom. All Rights Reserved. The term "Broadcom" refers to Broadcom Inc. and/or its subsidiaries. For more information, go to www.broadcom.com. All trademarks, trade names, service marks, and logos referenced herein belong to their respective companies.

Broadcom reserves the right to make changes without further notice to any products or data herein to improve reliability, function, or design. Information furnished by Broadcom is believed to be accurate and reliable. However, Broadcom does not assume any liability arising out of the application or use of this information, nor the application or use of any product or circuit described herein, neither does it convey any license under its patent rights nor the rights of others.