

# BGA777N7

Single-Band UMTS LNA (2300 - 2700 MHz)

## Data Sheet

Revision 3.1, 2013-01-31

**Edition 2013-01-31**

**Published by  
Infineon Technologies AG  
81726 Munich, Germany**

**© 2013 Infineon Technologies AG  
All Rights Reserved.**

### **Legal Disclaimer**

The information given in this document shall in no event be regarded as a guarantee of conditions or characteristics. With respect to any examples or hints given herein, any typical values stated herein and/or any information regarding the application of the device, Infineon Technologies hereby disclaims any and all warranties and liabilities of any kind, including without limitation, warranties of non-infringement of intellectual property rights of any third party.

### **Information**

For further information on technology, delivery terms and conditions and prices, please contact the nearest Infineon Technologies Office ([www.infineon.com](http://www.infineon.com)).

### **Warnings**

Due to technical requirements, components may contain dangerous substances. For information on the types in question, please contact the nearest Infineon Technologies Office.

Infineon Technologies components may be used in life-support devices or systems only with the express written approval of Infineon Technologies, if a failure of such components can reasonably be expected to cause the failure of that life-support device or system or to affect the safety or effectiveness of that device or system. Life support devices or systems are intended to be implanted in the human body or to support and/or maintain and sustain and/or protect human life. If they fail, it is reasonable to assume that the health of the user or other persons may be endangered.

**BGA777N7 Single-Band UMTS LNA (2300 - 2700 MHz)**

**Revision History: 2013-01-31, Revision 3.1**

**Previous Revision: 2012-10-31, Revision 3.0**

Page	Subjects (major changes since last revision)
33	Footprint recommendation drawing added
34	Marking pattern drawing updated

**Trademarks of Infineon Technologies AG**

AURIX™, C166™, CanPAK™, CIPOS™, CIPURSE™, EconoPACK™, CoolMOS™, CoolSET™, CORECONTROL™, CROSSAVE™, DAVE™, DI-POL™, EasyPIM™, EconoBRIDGE™, EconoDUAL™, EconoPIM™, EconoPACK™, EiceDRIVER™, eupec™, FCOS™, HITFET™, HybridPACK™, I<sup>2</sup>RF™, ISOFACE™, IsoPACK™, MIPAQ™, ModSTACK™, my-d™, NovalithIC™, OptiMOS™, ORIGA™, POWERCODE™, PRIMARION™, PrimePACK™, PrimeSTACK™, PRO-SIL™, PROFET™, RASIC™, ReverSave™, SatRIC™, SIEGET™, SINDRION™, SIPMOS™, SmartLEWIS™, SOLID FLASH™, TEMPFET™, thinQ!™, TRENCHSTOP™, TriCore™.

**Other Trademarks**

Advance Design System™ (ADS) of Agilent Technologies, AMBA™, ARM™, MULTI-ICETM, KEIL™, PRIMECELL™, REALVIEW™, THUMB™, μVision™ of ARM Limited, UK. AUTOSAR™ is licensed by AUTOSAR development partnership. Bluetooth™ of Bluetooth SIG Inc. CAT-iq™ of DECT Forum. COLOSSUS™, FirstGPS™ of Trimble Navigation Ltd. EMV™ of EMVCo, LLC (Visa Holdings Inc.). EPCOS™ of Epcos AG. FLEXGO™ of Microsoft Corporation. FlexRay™ is licensed by FlexRay Consortium. HYPERTERMINAL™ of Hilgraeve Incorporated. IEC™ of Commission Electrotechnique Internationale. IrDA™ of Infrared Data Association Corporation. ISO™ of INTERNATIONAL ORGANIZATION FOR STANDARDIZATION. MATLAB™ of MathWorks, Inc. MAXIM™ of Maxim Integrated Products, Inc. MICROTEC™, NUCLEUS™ of Mentor Graphics Corporation. MIPI™ of MIPI Alliance, Inc. MIPS™ of MIPS Technologies, Inc., USA. muRata™ of MURATA MANUFACTURING CO., MICROWAVE OFFICE™ (MWO) of Applied Wave Research Inc., OmniVision™ of OmniVision Technologies, Inc. Openwave™ Openwave Systems Inc. RED HAT™ Red Hat, Inc. RFMD™ RF Micro Devices, Inc. SIRIUS™ of Sirius Satellite Radio Inc. SOLARIS™ of Sun Microsystems, Inc. SPANSION™ of Spansion LLC Ltd. Symbian™ of Symbian Software Limited. TAIYO YUDEN™ of Taiyo Yuden Co. TEAKLITE™ of CEVA, Inc. TEKTRONIX™ of Tektronix Inc. TOKO™ of TOKO KABUSHIKI KAISHA TA. UNIX™ of X/Open Company Limited. VERILOG™, PALLADIUM™ of Cadence Design Systems, Inc. VLYNQ™ of Texas Instruments Incorporated. VXWORKS™, WIND RIVER™ of WIND RIVER SYSTEMS, INC. ZETEX™ of Diodes Zetex Limited.

Last Trademarks Update 2011-11-11

## Table of Contents

	<b>Table of Contents</b> .....	4
	<b>List of Figures</b> .....	5
	<b>List of Tables</b> .....	6
<b>1</b>	<b>Features</b> .....	7
<b>2</b>	<b>Electrical Characteristics</b> .....	9
2.1	Absolute Maximum Ratings .....	9
2.2	Thermal Resistance .....	9
2.3	ESD Integrity .....	9
2.4	DC Characteristics .....	10
2.5	Gain Mode Select Truth Table .....	10
2.6	Switching Times .....	10
2.7	Supply Current Characteristics .....	11
2.8	Logic Signal Characteristics .....	12
2.9	Measured RF Characteristics UMTS Band 7 .....	13
2.10	Measured RF Characteristics UMTS Band 7 .....	14
2.11	Measured RF Characteristics UMTS Band 7 .....	15
2.12	Measured RF Characteristics UMTS Band 38 .....	16
2.13	Measured RF Characteristics UMTS Band 38 .....	17
2.14	Measured RF Characteristics UMTS Band 38 .....	18
2.15	Measured RF Characteristics UMTS Band 40 .....	19
2.16	Measured RF Characteristics UMTS Band 40 .....	20
2.17	Measured RF Characteristics UMTS Band 40 .....	21
2.18	Measured Performance Band 7 Application High Gain Mode vs. Frequency .....	22
2.19	Measured Performance Band 7 Application High Gain Mode vs. Temperature .....	24
2.20	Measured Performance Band 7 Application Low Gain Mode vs. Frequency .....	25
2.21	Measured Performance Band 7 Application Low Gain Mode vs. Temperature .....	27
<b>3</b>	<b>Application Circuit and Block Diagram</b> .....	28
3.1	UMTS Band 7 Application Circuit Schematic .....	28
3.2	UMTS Band 38 Application Circuit Schematic .....	29
3.3	UMTS Band 40 Application Circuit Schematic .....	30
3.4	Pin Definition .....	30
3.5	Application Board .....	31
<b>4</b>	<b>Physical Characteristics</b> .....	33
4.1	Package Footprint .....	33
4.2	Package Dimensions .....	34
4.3	Product Marking Pattern .....	34

## List of Figures

Figure 1	Block Diagram of Single-Band LNA	8
Figure 2	Application Circuit with Chip Outline (Top View)	28
Figure 3	Application Circuit with Chip Outline (Top View)	29
Figure 4	Application Circuit with Chip Outline (Top View)	30
Figure 5	Application Board Layout on 3-Layer FR4	31
Figure 6	Cross-Section View of Application Board	31
Figure 7	Detail of Application Board Layout	32
Figure 8	Footprint Recommendation 1 for the TSNP-7-1 Package	33
Figure 9	Footprint Recommendation 2 for the TSNP-7-1 Package	33
Figure 10	Package Outline (top, side and bottom view)	34
Figure 11	Tape & Reel Dimensions	34
Figure 12	Marking Pattern (top view)	34

## List of Tables

Table 1	Absolute Maximum Ratings .....	9
Table 2	Thermal Resistance .....	9
Table 3	ESD Integrity .....	9
Table 4	DC Characteristics, $T_A = -30 \dots 85 \text{ }^\circ\text{C}$ .....	10
Table 5	Truth Table .....	10
Table 6	Typical switching times; $T_A = -30 \dots 85 \text{ }^\circ\text{C}$ .....	10
Table 7	Typical Characteristics 2650 MHz Band, $T_A = -30 \text{ }^\circ\text{C}$ , $V_{CC} = 2.8 \text{ V}$ .....	13
Table 8	Typical Characteristics 2650 MHz Band, $T_A = 25 \text{ }^\circ\text{C}$ , $V_{CC} = 2.8 \text{ V}$ .....	14
Table 9	Typical Characteristics 2650 MHz Band, $T_A = 85 \text{ }^\circ\text{C}$ , $V_{CC} = 2.8 \text{ V}$ .....	15
Table 10	Typical Characteristics 2600 MHz Band, $T_A = -30 \text{ }^\circ\text{C}$ , $V_{CC} = 2.8 \text{ V}$ .....	16
Table 11	Typical Characteristics 2600 MHz Band, $T_A = 25 \text{ }^\circ\text{C}$ , $V_{CC} = 2.8 \text{ V}$ .....	17
Table 12	Typical Characteristics 2600 MHz Band, $T_A = 85 \text{ }^\circ\text{C}$ , $V_{CC} = 2.8 \text{ V}$ .....	18
Table 13	Typical Characteristics 2300 MHz Band, $T_A = -30 \text{ }^\circ\text{C}$ , $V_{CC} = 2.8 \text{ V}$ .....	19
Table 14	Typical Characteristics 2300 MHz Band, $T_A = 25 \text{ }^\circ\text{C}$ , $V_{CC} = 2.8 \text{ V}$ .....	20
Table 15	Typical Characteristics 2300 MHz Band, $T_A = 85 \text{ }^\circ\text{C}$ , $V_{CC} = 2.8 \text{ V}$ .....	21
Table 16	Bill of Materials .....	28
Table 17	Bill of Materials .....	29
Table 18	Bill of Materials .....	30
Table 19	Pin Definition and Function .....	30

## 1 Features

Main features:

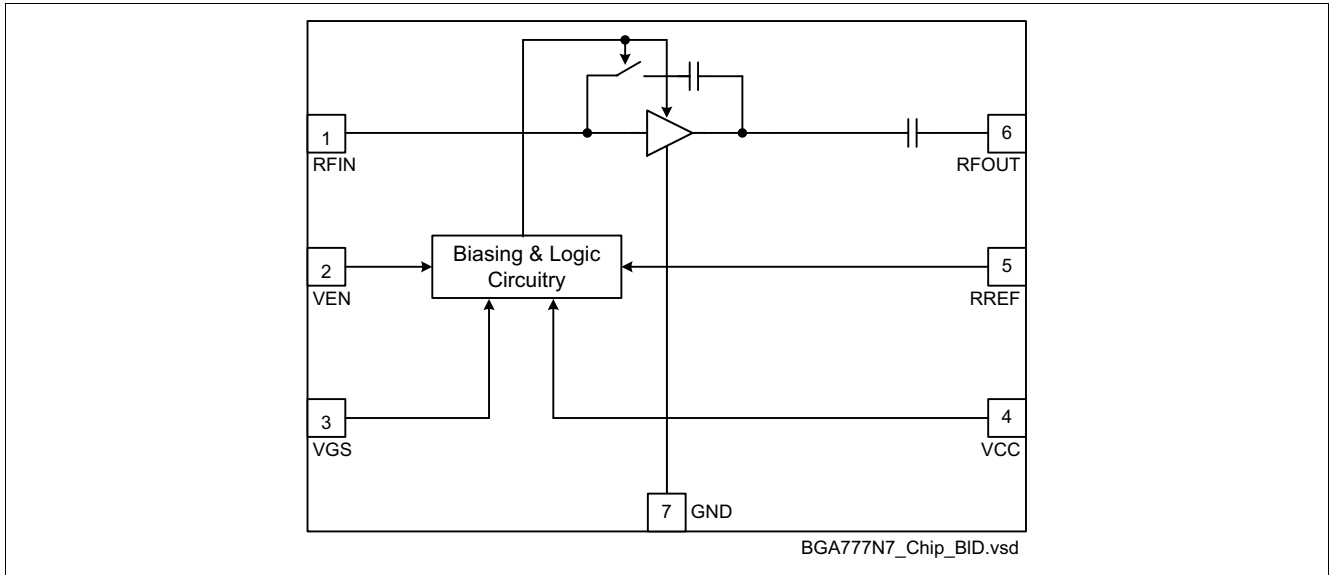
- Gain: 16 / -7 dB in high / low gain mode
- Noise figure: 1.2 dB in high gain mode
- Supply current: 4.2 / 0.5 mA in high / low gain mode
- Standby mode (< 2  $\mu$ A typ.)
- Output internally matched to 50  $\Omega$
- Inputs pre-matched to 50  $\Omega$
- 2 kV HBM ESD protection
- Low external component count
- Small leadless TSNP-7-1 package (2.0 x 1.3 x 0.39 mm)
- Pb-free (RoHS compliant) package



### Description

The BGA777N7 is a low current single-band low noise amplifier MMIC for UMTS bands 7, 38 and 40. The LNA is based upon Infineon's proprietary and cost-effective SiGe:C technology and comes in a low profile TSNP-7-1 leadless green package. This document specifies electrical parameters, pinout, application circuit and packaging of the chip. The device features dynamic gain control, temperature stabilization, standby mode and 2 kV ESD protection on-chip as well as matching off chip.

Product Name	Package	Chip	Marking
BGA777N7	TSNP-7-1	T1531	B7



**Figure 1** Block Diagram of Single-Band LNA



## 2 Electrical Characteristics

### 2.1 Absolute Maximum Ratings

**Table 1 Absolute Maximum Ratings**

Parameter	Symbol	Values			Unit	Note / Test Condition
		Min.	Typ.	Max.		
Supply voltage	$V_{CC}$	-0.3	–	3.6	V	–
Supply current	$I_{CC}$	–	–	10	mA	–
Pin voltage	$V_{PIN}$	-0.3	–	$V_{CC}+0.3$	V	All pins except RF input pins.
Pin voltage RF Input Pins	$V_{RFIN}$	-0.3	–	0.9	V	–
RF input power	$P_{RFIN}$	–	–	4	dBm	–
Junction temperature	$T_j$	–	–	150	°C	–
Ambient temperature range	$T_A$	-30	–	85	°C	–
Storage temperature range	$T_{stg}$	-65	–	150	°C	–

**Attention: Stresses above the max. values listed here may cause permanent damage to the device. Exposure to absolute maximum rating conditions for extended periods may affect device reliability. Maximum ratings are absolute ratings; exceeding only one of these values may cause irreversible damage to the integrated circuit.**

### 2.2 Thermal Resistance

**Table 2 Thermal Resistance**

Parameter	Symbol	Values			Unit	Note / Test Condition
		Min.	Typ.	Max.		
Thermal resistance junction to soldering point	$R_{thJS}$	–	240	–	K/W	–

### 2.3 ESD Integrity

**Table 3 ESD Integrity**

Parameter	Symbol	Values			Unit	Note / Test Condition
		Min.	Typ.	Max.		
ESD hardness HBM <sup>1)</sup>	$V_{ESD-HBM}$	–	2000	–	V	All pins

1) According to JESD22-A114

## 2.4 DC Characteristics

**Table 4** DC Characteristics,  $T_A = -30 \dots 85 \text{ }^\circ\text{C}$

Parameter	Symbol	Values			Unit	Note / Test Condition
		Min.	Typ.	Max.		
Supply voltage	$V_{CC}$	2.6	2.8	3.0	V	–
Supply current high gain mode	$I_{CCHG}$	2.8	4.2	5.8	mA	
Supply current low gain mode	$I_{CCLG}$	0.2	0.53	0.8	mA	
Supply current standby mode	$I_{CCOFF}$	-0.5	0.1	2.0	$\mu\text{A}$	–
Logic level high	$V_{HI}$	1.5	2.8	3.0	V	All logic pins
Logic level low	$V_{LO}$	-0.2	0.0	0.5	V	
Logic currents	$I_{LO}$	-0.5	0.01	2.0	$\mu\text{A}$	All logic pins
	$I_{HI}$	4.0	5.0	6.0	$\mu\text{A}$	

## 2.5 Gain Mode Select Truth Table

**Table 5** Truth Table

Control Voltage		State	
		Bands 7, 38, 40	
VEN	VGS	HG	LG
H	L	OFF	ON
H	H	ON	OFF
L	L	STANDBY <sup>1)</sup>	
L	H		

1) In order to achieve minimum standby current it is encouraged to apply logic low-level at the VGS pin in standby mode although this is not mandatory. Details see section 2.4.

## 2.6 Switching Times

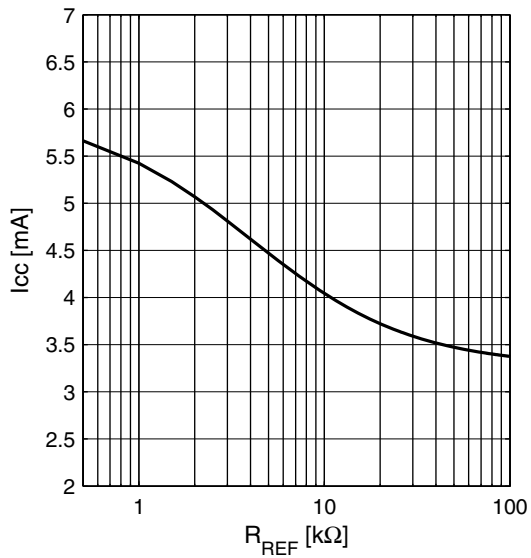
**Table 6** Typical switching times;  $T_A = -30 \dots 85 \text{ }^\circ\text{C}$

Parameter	Symbol	Values			Unit	Note / Test Condition
		Min.	Typ.	Max.		
Settling time gainstep	$t_{GS}$	–	1	5	$\mu\text{s}$	Switching LG $\leftrightarrow$ HG

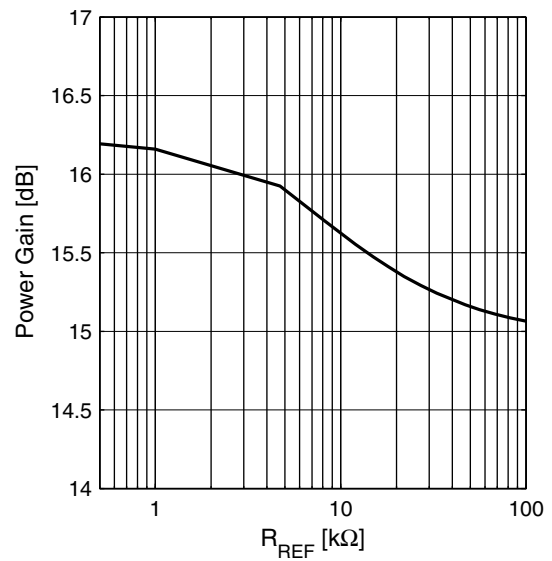
## 2.7 Supply Current Characteristics

Supply current high gain mode versus resistance of reference resistor  $R_{REF}$  (see Figure 2 on Page 28; low gain mode supply current is independent of reference resistor).

**Supply Current**  $I_{CC} = f(R_{REF})$   
 $V_{CC} = 2.8 \text{ V}$ ,  $T_A = 25 \text{ }^\circ\text{C}$



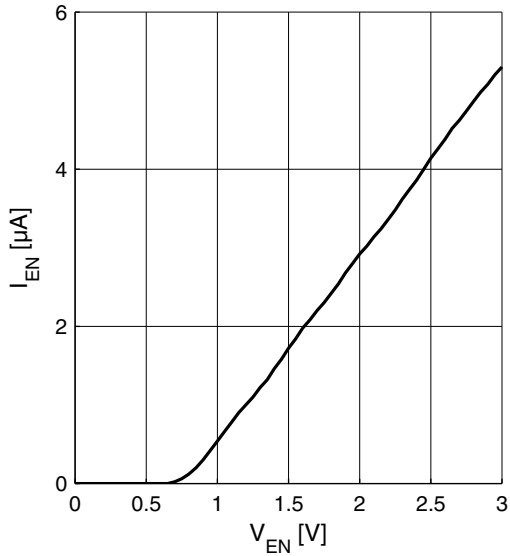
**Power Gain**  $|S_{21}| = f(R_{REF})$   
 $V_{CC} = 2.8 \text{ V}$ ,  $T_A = 25 \text{ }^\circ\text{C}$



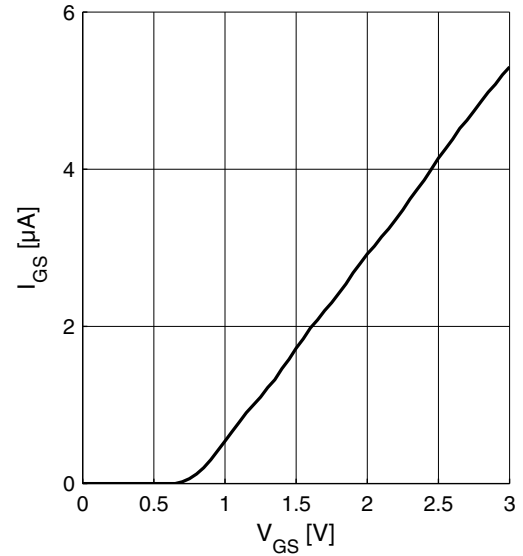
## 2.8 Logic Signal Characteristics

Current consumption of logic inputs VEN, VGS

**Logic Current  $I_{EN} = f(V_{EN})$**   
 $V_{CC} = 2.8 \text{ V}$ ,  $T_A = 25 \text{ }^\circ\text{C}$



**Logic Current  $I_{GS} = f(V_{GS})$**   
 $V_{CC} = 2.8 \text{ V}$ ,  $T_A = 25 \text{ }^\circ\text{C}$



## 2.9 Measured RF Characteristics UMTS Band 7

**Table 7** Typical Characteristics 2650 MHz Band,  $T_A = -30\text{ °C}$ ,  $V_{CC} = 2.8\text{ V}^{1)2)}$

Parameter	Symbol	Values			Unit	Note / Test Condition
		Min.	Typ.	Max.		
Pass band range band VII		2620	–	2690	MHz	–
Current consumption	$I_{CCHG}$	2.8	3.4	4.0	mA	High gain mode
	$I_{CCLG}$	0.2	0.5	0.8	mA	Low gain mode
Gain	$S_{21HG}$	14.5	16.0	17.5	dB	High gain mode
	$S_{21LG}$	-8.8	-6.3	-3.3	dB	Low gain mode
Reverse Isolation	$S_{12HG}$	–	-34	-25	dB	High gain mode
	$S_{12LG}$	-8.8	-6.3	-3.3	dB	Low gain mode
Noise figure	$NF_{HG}$	0.6	0.9	1.4	dB	High gain mode
	$NF_{LG}$	3.3	6.3	8.8	dB	Low gain mode
Input return loss	$S_{11HG}$	–	-16	-10	dB	50 $\Omega$ , high gain mode
	$S_{11LG}$	–	-11	-9	dB	50 $\Omega$ , low gain mode
Output return loss	$S_{22HG}$	–	-16	-10	dB	50 $\Omega$ , high gain mode
	$S_{22LG}$	–	-10	-8	dB	50 $\Omega$ , low gain mode
Stability factor	$k$	>1	>2.3	–		DC to 8 GHz; all gain modes
Input compression point	$IP_{1dBHG}$	-16	-9	–	dBm	High gain mode
	$IP_{1dBLG}$	-10	-2	–	dBm	Low gain mode
Inband IIP3 $f_1 - f_2 = 1\text{ MHz}$	$IIP3_{HG}$	-9	-2	–	dBm	High gain mode
	$IIP3_{LG}$	-7	5	–	dBm	Low gain mode

1) Performance based on application circuit in Figure 2 on Page 28

2) Guaranteed by device design; not tested in production.

## 2.10 Measured RF Characteristics UMTS Band 7

**Table 8** Typical Characteristics 2650 MHz Band,  $T_A = 25\text{ °C}$ ,  $V_{CC} = 2.8\text{ V}^{1)}$

Parameter	Symbol	Values			Unit	Note / Test Condition
		Min.	Typ.	Max.		
Pass band range band VII		2620	–	2690	MHz	–
Current consumption	$I_{CCHG}$	3.6	4.2	4.8	mA	High gain mode
	$I_{CCLG}$	0.3	0.53	0.7	mA	Low gain mode
Gain	$S_{21HG}$	14.4	15.7	17.0	dB	High gain mode
	$S_{21LG}$	-9.6	-7.1	-4.1	dB	Low gain mode
Reverse Isolation <sup>2)</sup>	$S_{12HG}$	–	-34	-25	dB	High gain mode
	$S_{12LG}$	-9.5	-7.0	-4.0	dB	Low gain mode
Noise figure	$NF_{HG}$	0.9	1.2	1.7	dB	High gain mode
	$NF_{LG}$	3.8	6.8	9.3	dB	Low gain mode
Input return loss <sup>2)</sup>	$S_{11HG}$	–	-20	-10	dB	50 $\Omega$ , high gain mode
	$S_{11LG}$	–	-10	-8	dB	50 $\Omega$ , low gain mode
Output return loss <sup>2)</sup>	$S_{22HG}$	–	-20	-10	dB	50 $\Omega$ , high gain mode
	$S_{22LG}$	–	-11	-9	dB	50 $\Omega$ , low gain mode
Stability factor <sup>3)</sup>	$k$	>1	>2.3	–		DC to 8 GHz; all gain modes
Input compression point <sup>2)</sup>	$IP_{1dBHG}$	-17	-10	–	dBm	High gain mode
	$IP_{1dBLG}$	-10	-2	–	dBm	Low gain mode
Inband IIP3 <sup>2)</sup> $f_1 - f_2 = 1\text{ MHz}$	$IIP3_{HG}$	-9	-2	–	dBm	High gain mode
	$IIP3_{LG}$	-5	7	–		Low gain mode

1) Performance based on application circuit in Figure 2 on Page 28

2) Verification based on AQL; random production test..

3) Guaranteed by device design; not tested in production.

## 2.11 Measured RF Characteristics UMTS Band 7

**Table 9** Typical Characteristics 2650 MHz Band,  $T_A = 85\text{ °C}$ ,  $V_{CC} = 2.8\text{ V}^{1)2)}$

Parameter	Symbol	Values			Unit	Note / Test Condition
		Min.	Typ.	Max.		
Pass band range band VII		2620	–	2690	MHz	–
Current consumption	$I_{CCHG}$	4.6	5.2	5.8	mA	High gain mode
	$I_{CCLG}$	0.2	0.58	0.8	mA	Low gain mode
Gain	$S_{21HG}$	13.1	14.6	16.1	dB	High gain mode
	$S_{21LG}$	-10.4	-7.9	-4.9	dB	Low gain mode
Reverse Isolation	$S_{12HG}$	–	-34	-25	dB	High gain mode
	$S_{12LG}$	-10.4	-7.9	-4.9	dB	Low gain mode
Noise figure	$NF_{HG}$	1.4	1.7	2.2	dB	High gain mode
	$NF_{LG}$	4.9	7.9	10.4	dB	Low gain mode
Input return loss	$S_{11HG}$	–	-16	-10	dB	50 $\Omega$ , high gain mode
	$S_{11LG}$	–	-11	-9	dB	50 $\Omega$ , low gain mode
Output return loss	$S_{22HG}$	–	-20	-10	dB	50 $\Omega$ , high gain mode
	$S_{22LG}$	–	-11	-9	dB	50 $\Omega$ , low gain mode
Stability factor	$k$	>1	>2.3	–		DC to 8 GHz; all gain modes
Input compression point	$IP_{1dBHG}$	-17	-10	–	dBm	High gain mode
	$IP_{1dBLG}$	-10	-2	–	dBm	Low gain mode
Inband IIP3 $f_1 - f_2 = 1\text{ MHz}$	$IIP3_{HG}$	-9	-2	–	dBm	High gain mode
	$IIP3_{LG}$	-3	9	–	dBm	Low gain mode

1) Performance based on application circuit in Figure 2 on Page 28

2) Guaranteed by device design; not tested in production.

## 2.12 Measured RF Characteristics UMTS Band 38

**Table 10** Typical Characteristics 2600 MHz Band,  $T_A = -30\text{ °C}$ ,  $V_{CC} = 2.8\text{ V}^{1)2)}$

Parameter	Symbol	Values			Unit	Note / Test Condition
		Min.	Typ.	Max.		
Pass band range band XXXVIII		2570	–	2620	MHz	–
Current consumption	$I_{CCHG}$	2.8	3.4	4.0	mA	High gain mode
	$I_{CCLG}$	0.2	0.5	0.8	mA	Low gain mode
Gain	$S_{21HG}$	14.7	16.2	17.7	dB	High gain mode
	$S_{21LG}$	-8.5	-6.0	-3.0	dB	Low gain mode
Reverse Isolation	$S_{12HG}$	–	-34	-25	dB	High gain mode
	$S_{12LG}$	-8.5	-6.0	-3.0	dB	Low gain mode
Noise figure	$NF_{HG}$	0.6	0.9	1.4	dB	High gain mode
	$NF_{LG}$	3.0	6.0	8.5	dB	Low gain mode
Input return loss	$S_{11HG}$	–	-15	-10	dB	50 $\Omega$ , high gain mode
	$S_{11LG}$	–	-13	-10	dB	50 $\Omega$ , low gain mode
Output return loss	$S_{22HG}$	–	-11	-9	dB	50 $\Omega$ , high gain mode
	$S_{22LG}$	–	-18	-10	dB	50 $\Omega$ , low gain mode
Stability factor	$k$	>1	>2.3	–		DC to 8 GHz; all gain modes
Input compression point	$IP_{1dBHG}$	-16	-9	–	dBm	High gain mode
	$IP_{1dBLG}$	-10	-2	–	dBm	Low gain mode
Inband IIP3 $f_1 - f_2 = 1\text{ MHz}$	$IIP3_{HG}$	-9	-2	–	dBm	High gain mode
	$IIP3_{LG}$	-7	5	–	dBm	Low gain mode

1) Performance based on application circuit in Figure 3 on Page 29

2) Guaranteed by device design; not tested in production.



## 2.13 Measured RF Characteristics UMTS Band 38

**Table 11** Typical Characteristics 2600 MHz Band,  $T_A = 25\text{ °C}$ ,  $V_{CC} = 2.8\text{ V}$ <sup>1)2)</sup>

Parameter	Symbol	Values			Unit	Note / Test Condition
		Min.	Typ.	Max.		
Pass band range band XXXVIII		2570	–	2620	MHz	–
Current consumption	$I_{CCHG}$	3.6	4.2	4.8	mA	High gain mode
	$I_{CCLG}$	0.3	0.53	0.7	mA	Low gain mode
Gain	$S_{21HG}$	14.2	15.5	16.8	dB	High gain mode
	$S_{21LG}$	-9.4	-6.9	-3.9	dB	Low gain mode
Reverse Isolation	$S_{12HG}$	–	-34	-25	dB	High gain mode
	$S_{12LG}$	-9.5	-7.0	-4.0	dB	Low gain mode
Noise figure	$NF_{HG}$	0.9	1.2	1.7	dB	High gain mode
	$NF_{LG}$	3.8	6.8	9.3	dB	Low gain mode
Input return loss	$S_{11HG}$	–	-15	-10	dB	50 $\Omega$ , high gain mode
	$S_{11LG}$	–	-11	-9	dB	50 $\Omega$ , low gain mode
Output return loss	$S_{22HG}$	–	-15	-10	dB	50 $\Omega$ , high gain mode
	$S_{22LG}$	–	-13	-10	dB	50 $\Omega$ , low gain mode
Stability factor	$k$	>1	>2.3	–		DC to 8 GHz; all gain modes
Input compression point	$IP_{1dBHG}$	-17	-10	–	dBm	High gain mode
	$IP_{1dB LG}$	-10	-2	–	dBm	Low gain mode
Inband IIP3 $f_1 - f_2 = 1\text{ MHz}$	$IIP3_{HG}$	-9	-2	–	dBm	High gain mode
	$IIP3_{LG}$	-5	7	–	dBm	Low gain mode

1) Performance based on application circuit in Figure 3 on Page 29

2) Guaranteed by device design; not tested in production.

## 2.14 Measured RF Characteristics UMTS Band 38

**Table 12** Typical Characteristics 2600 MHz Band,  $T_A = 85\text{ °C}$ ,  $V_{CC} = 2.8\text{ V}^{1)2)}$

Parameter	Symbol	Values			Unit	Note / Test Condition
		Min.	Typ.	Max.		
Pass band range band XXXVIII		2570	–	2620	MHz	–
Current consumption	$I_{CCHG}$	4.6	5.2	5.8	mA	High gain mode
	$I_{CCLG}$	0.2	0.58	0.8	mA	Low gain mode
Gain	$S_{21HG}$	13.4	14.9	16.4	dB	High gain mode
	$S_{21LG}$	-9.9	-7.4	-4.4	dB	Low gain mode
Reverse Isolation	$S_{12HG}$	–	-34	-25	dB	High gain mode
	$S_{12LG}$	-9.9	-7.4	-4.4	dB	Low gain mode
Noise figure	$NF_{HG}$	1.4	1.7	2.2	dB	High gain mode
	$NF_{LG}$	4.4	7.4	-9.9	dB	Low gain mode
Input return loss	$S_{11HG}$	–	-16	-10	dB	50 $\Omega$ , high gain mode
	$S_{11LG}$	–	-13	-10	dB	50 $\Omega$ , low gain mode
Output return loss	$S_{22HG}$	–	-16	-10	dB	50 $\Omega$ , high gain mode
	$S_{22LG}$	–	-15	-10	dB	50 $\Omega$ , low gain mode
Stability factor	$k$	>1	>2.3	–		DC to 8 GHz; all gain modes
Input compression point	$IP_{1dBHG}$	-18	-11	–	dBm	High gain mode
	$IP_{1dBLG}$	-10	-2	–	dBm	Low gain mode
Inband IIP3 $f_1 - f_2 = 1\text{ MHz}$	$IIP3_{HG}$	-9	-2	–	dBm	High gain mode
	$IIP3_{LG}$	-3	9	–	dBm	Low gain mode

1) Performance based on application circuit in Figure 3 on Page 29

2) Guaranteed by device design; not tested in production.

## 2.15 Measured RF Characteristics UMTS Band 40

**Table 13** Typical Characteristics 2300 MHz Band,  $T_A = -30\text{ °C}$ ,  $V_{CC} = 2.8\text{ V}^{1)2)}$

Parameter	Symbol	Values			Unit	Note / Test Condition
		Min.	Typ.	Max.		
Pass band range band XL		2300	–	2400	MHz	–
Current consumption	$I_{CCHG}$	2.8	3.4	4.0	mA	High gain mode
	$I_{CCLG}$	0.2	0.5	0.8	mA	Low gain mode
Gain	$S_{21HG}$	15.8	17.3	18.8	dB	High gain mode
	$S_{21LG}$	-8.7	-6.2	-3.2	dB	Low gain mode
Reverse Isolation	$S_{12HG}$	–	-35	-25	dB	High gain mode
	$S_{12LG}$	-8.7	-6.2	-3.2	dB	Low gain mode
Noise figure	$NF_{HG}$	0.6	0.9	1.4	dB	High gain mode
	$NF_{LG}$	3.2	6.2	8.7	dB	Low gain mode
Input return loss	$S_{11HG}$	–	-17	-10	dB	50 $\Omega$ , high gain mode
	$S_{11LG}$	–	-13	-10	dB	50 $\Omega$ , low gain mode
Output return loss	$S_{22HG}$	–	-16	-10	dB	50 $\Omega$ , high gain mode
	$S_{22LG}$	–	-14	-10	dB	50 $\Omega$ , low gain mode
Stability factor	$k$	>1	>2.3	–		DC to 8 GHz; all gain modes
Input compression point	$IP_{1dBHG}$	-17	-10	–	dBm	High gain mode
	$IP_{1dBLG}$	-10	-2	–	dBm	Low gain mode
Inband IIP3 $f_1 - f_2 = 1\text{ MHz}$	$IIP3_{HG}$	-9	-2	–	dBm	High gain mode
	$IIP3_{LG}$	-7	5	–	dBm	Low gain mode

1) Performance based on application circuit in Figure 4 on Page 30

2) Guaranteed by device design; not tested in production.

## 2.16 Measured RF Characteristics UMTS Band 40

**Table 14** Typical Characteristics 2300 MHz Band,  $T_A = 25\text{ °C}$ ,  $V_{CC} = 2.8\text{ V}^{1)2)}$

Parameter	Symbol	Values			Unit	Note / Test Condition
		Min.	Typ.	Max.		
Pass band range band XL		2300	–	2400	MHz	–
Current consumption	$I_{CCHG}$	3.6	4.2	4.8	mA	High gain mode
	$I_{CCLG}$	0.3	0.53	0.7	mA	Low gain mode
Gain	$S_{21HG}$	15.5	16.8	18.1	dB	High gain mode
	$S_{21LG}$	-9.7	-7.2	-4.2	dB	Low gain mode
Reverse Isolation	$S_{12HG}$	–	-35	-25	dB	High gain mode
	$S_{12LG}$	-9.5	-7.0	-4.0	dB	Low gain mode
Noise figure	$NF_{HG}$	0.9	1.2	1.7	dB	High gain mode
	$NF_{LG}$	4.0	7.0	9.5	dB	Low gain mode
Input return loss	$S_{11HG}$	–	-23	-10	dB	50 $\Omega$ , high gain mode
	$S_{11LG}$	–	-12	-10	dB	50 $\Omega$ , low gain mode
Output return loss	$S_{22HG}$	–	-15	-10	dB	50 $\Omega$ , high gain mode
	$S_{22LG}$	–	-12	-10	dB	50 $\Omega$ , low gain mode
Stability factor	$k$	>1	>2.3	–		DC to 8 GHz; all gain modes
Input compression point	$IP_{1dBHG}$	-18	-11	–	dBm	High gain mode
	$IP_{1dBLG}$	-10	-2	–	dBm	Low gain mode
Inband IIP3 $f_1 - f_2 = 1\text{ MHz}$	$IIP3_{HG}$	-9	-2	–	dBm	High gain mode
	$IIP3_{LG}$	-5	7	–	dBm	Low gain mode

1) Performance based on application circuit in Figure 4 on Page 30

2) Guaranteed by device design; not tested in production.

## 2.17 Measured RF Characteristics UMTS Band 40

**Table 15** Typical Characteristics 2300 MHz Band,  $T_A = 85\text{ °C}$ ,  $V_{CC} = 2.8\text{ V}^{1)2)}$

Parameter	Symbol	Values			Unit	Note / Test Condition
		Min.	Typ.	Max.		
Pass band range band XL		2300	–	2400	MHz	–
Current consumption	$I_{CCHG}$	4.6	5.2	5.8	mA	High gain mode
	$I_{CCLG}$	0.2	0.58	0.8	mA	Low gain mode
Gain	$S_{21HG}$	14.5	16.0	17.5	dB	High gain mode
	$S_{21LG}$	-10.1	-7.6	-4.6	dB	Low gain mode
Reverse Isolation	$S_{12HG}$	–	-35	-25	dB	High gain mode
	$S_{12LG}$	-10.1	-7.6	-4.6	dB	Low gain mode
Noise figure	$NF_{HG}$	1.2	1.5	2.0	dB	High gain mode
	$NF_{LG}$	4.6	7.6	10.1	dB	Low gain mode
Input return loss	$S_{11HG}$	–	-18	-10	dB	50 $\Omega$ , high gain mode
	$S_{11LG}$	–	-13	-10	dB	50 $\Omega$ , low gain mode
Output return loss	$S_{22HG}$	–	-17	-10	dB	50 $\Omega$ , high gain mode
	$S_{22LG}$	–	-13	-10	dB	50 $\Omega$ , low gain mode
Stability factor	$k$	>1	>2.3	–		DC to 8 GHz; all gain modes
Input compression point	$IP_{1dBHG}$	-19	-12	–	dBm	High gain mode
	$IP_{1dBLG}$	-10	-2	–	dBm	Low gain mode
Inband IIP3 $f_1 - f_2 = 1\text{ MHz}$	$IIP3_{HG}$	-9	-2	–	dBm	High gain mode
	$IIP3_{LG}$	-3	9	–	dBm	Low gain mode

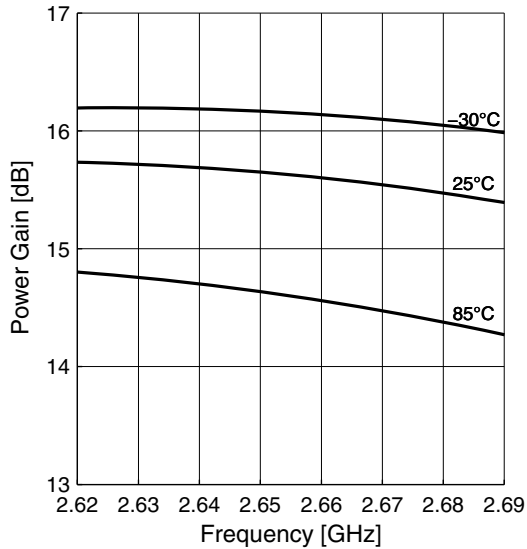
1) Performance based on application circuit in Figure 4 on Page 30

2) Guaranteed by device design; not tested in production.

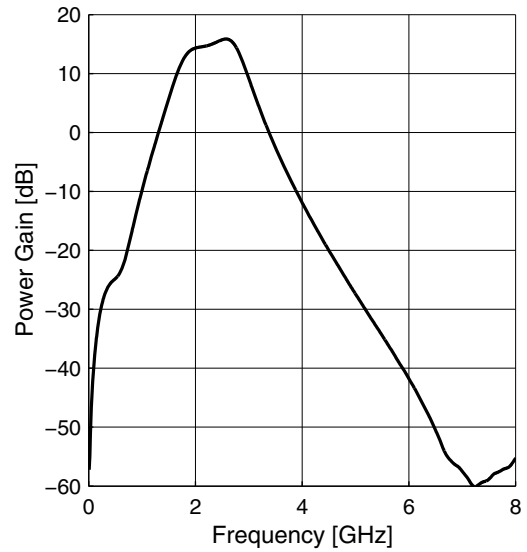
### 2.18 Measured Performance Band 7 Application High Gain Mode vs. Frequency

$T_A = 25\text{ }^\circ\text{C}$ ,  $V_{CC} = 2.8\text{ V}$ ,  $V_{GS} = 2.8\text{ V}$ ,  $V_{EN} = 2.8\text{ V}$

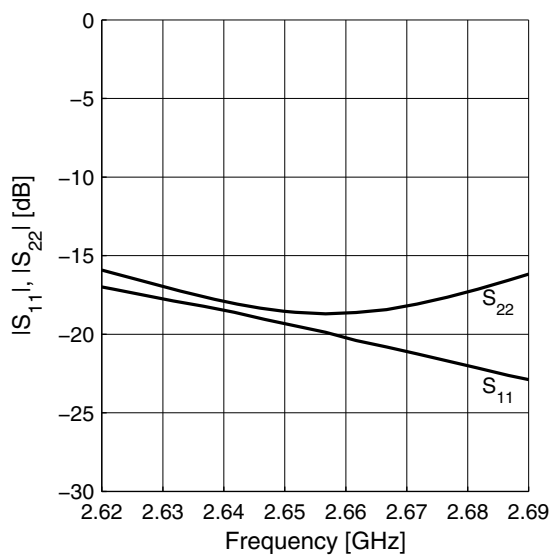
Power Gain  $|S_{21}| = f(f)$



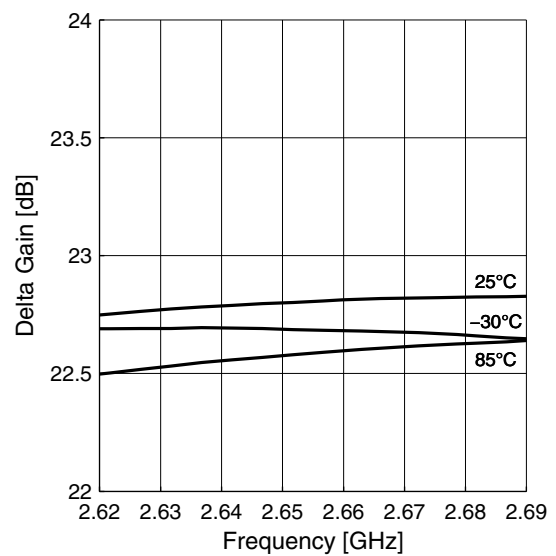
Power Gain wideband  $|S_{21}| = f(f)$



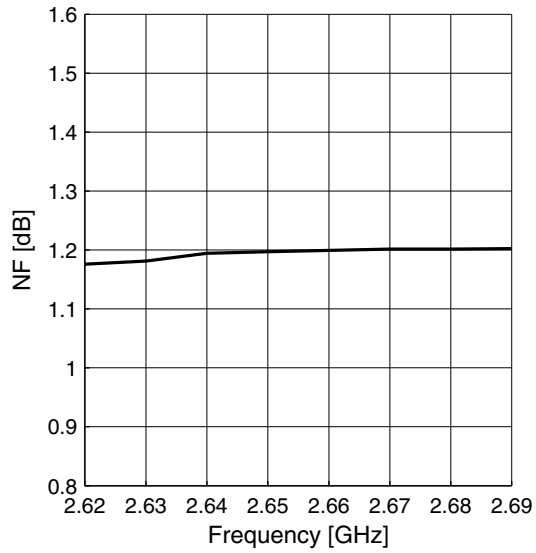
Matching  $|S_{11}| = f(f)$ ,  $|S_{22}| = f(f)$



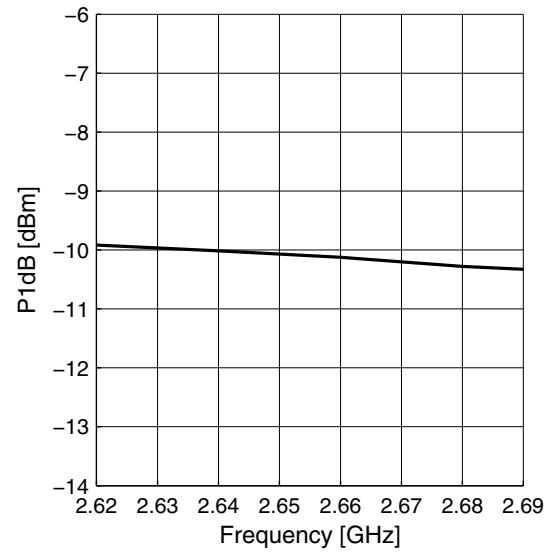
Gainstep HG-LG  $|\Delta S_{21}| = f(f)$



Noise Figure  $NF = f(f)$



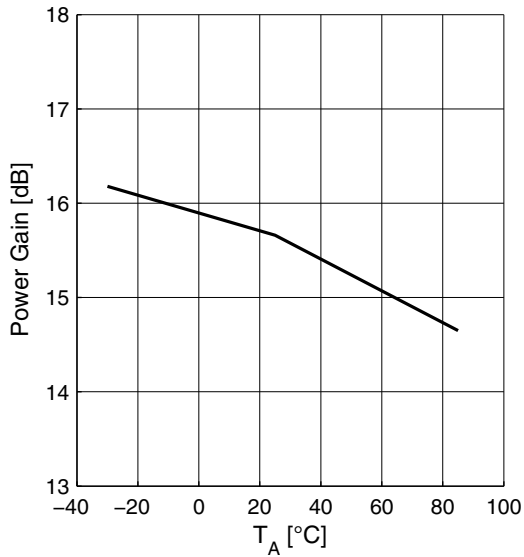
Input Compression  $P1dB = f(f)$



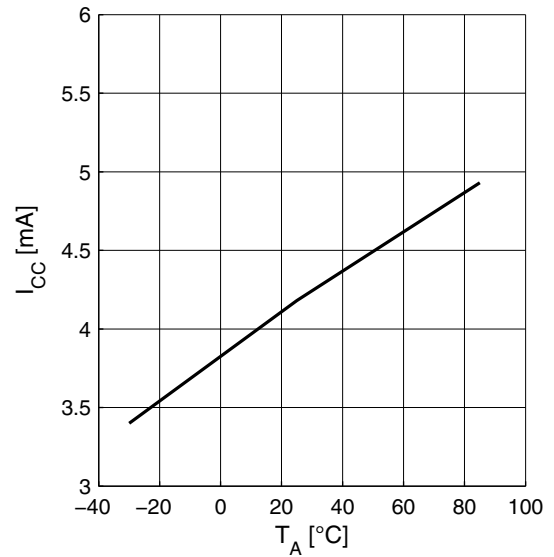
### 2.19 Measured Performance Band 7 Application High Gain Mode vs. Temperature

$T_A = 25\text{ }^\circ\text{C}$ ,  $V_{CC} = 2.8\text{ V}$ ,  $V_{GS} = 2.8\text{ V}$ ,  $V_{EN} = 2.8\text{ V}$ ,  $f = 2650\text{ MHz}$

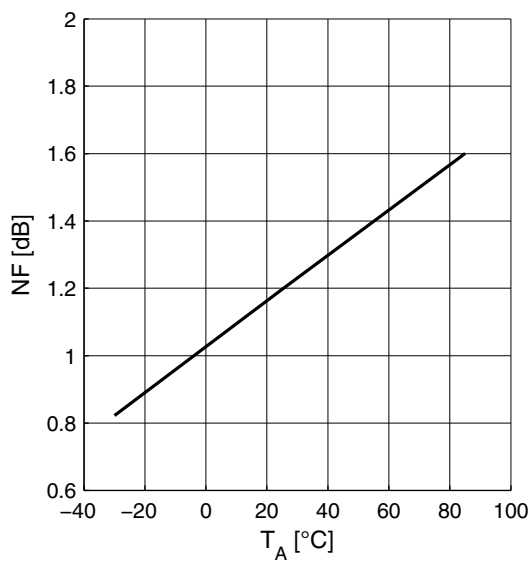
Power Gain  $|S_{21}| = f(T_A)$



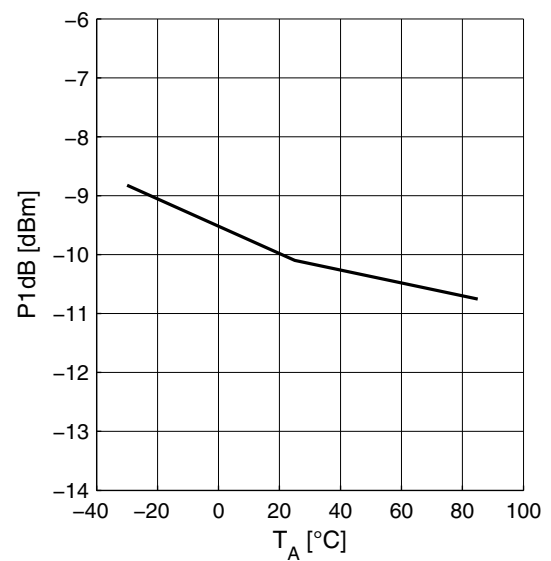
Supply Current  $I_{CC} = f(T_A)$



Noise Figure  $NF = f(T_A)$



Input Compression  $P1dB = f(T_A)$

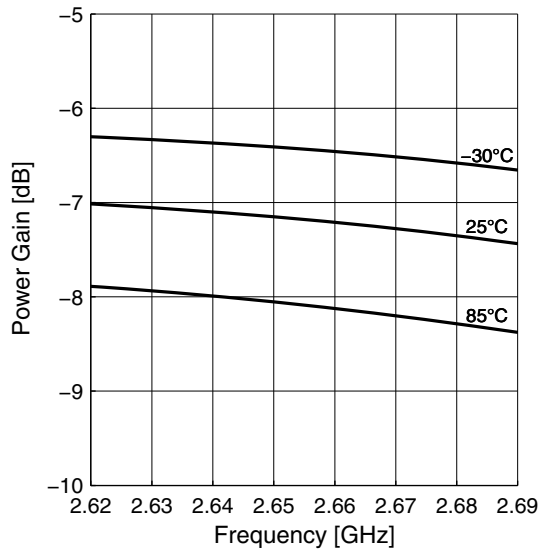




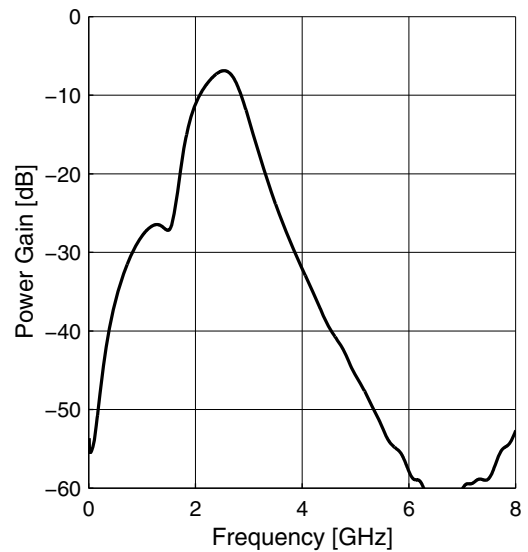
## 2.20 Measured Performance Band 7 Application Low Gain Mode vs. Frequency

$T_A = 25\text{ }^\circ\text{C}$ ,  $V_{CC} = 2.8\text{ V}$ ,  $V_{GS} = 0\text{ V}$ ,  $V_{EN} = 2.8\text{ V}$

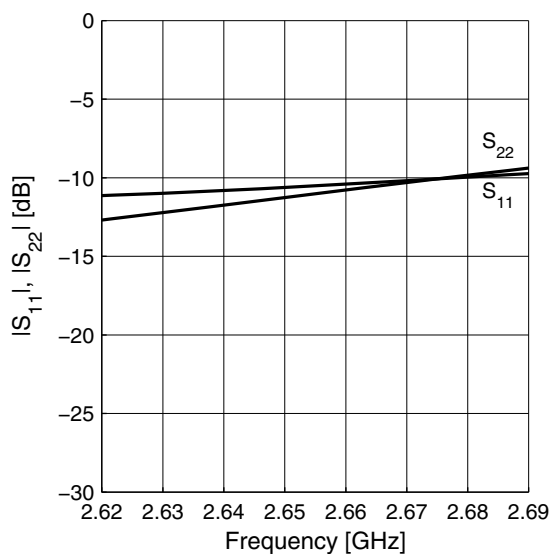
Power Gain  $|S_{21}| = f(f)$



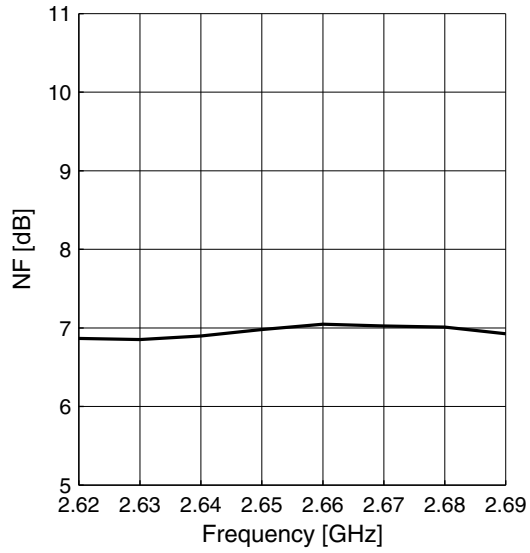
Power Gain wideband  $|S_{21}| = f(f)$



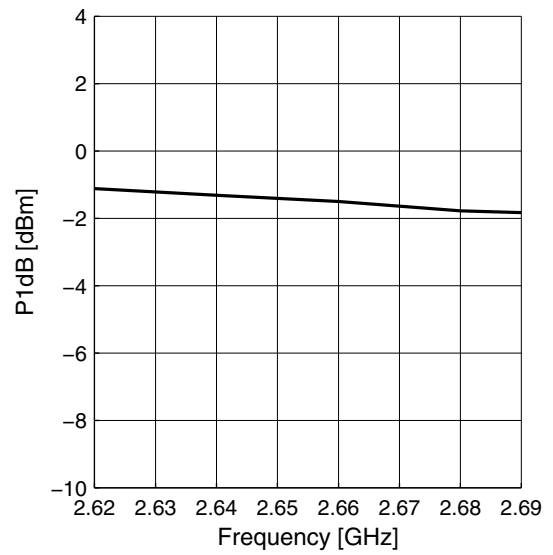
Matching  $|S_{11}| = f(f)$ ,  $|S_{22}| = f(f)$



**Noise Figure  $NF = f(f)$**



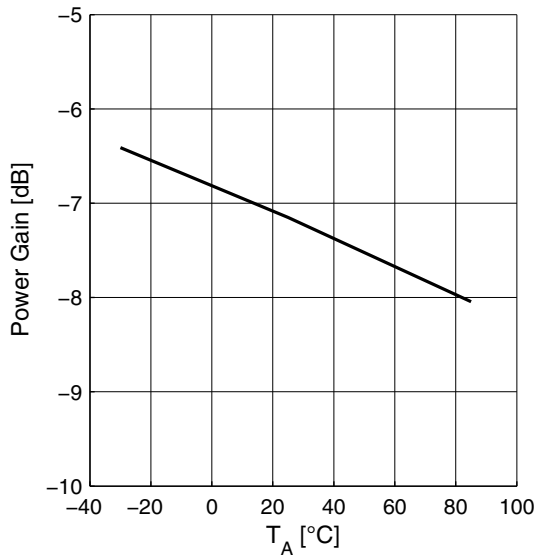
**Input Compression  $P1dB = f(f)$**



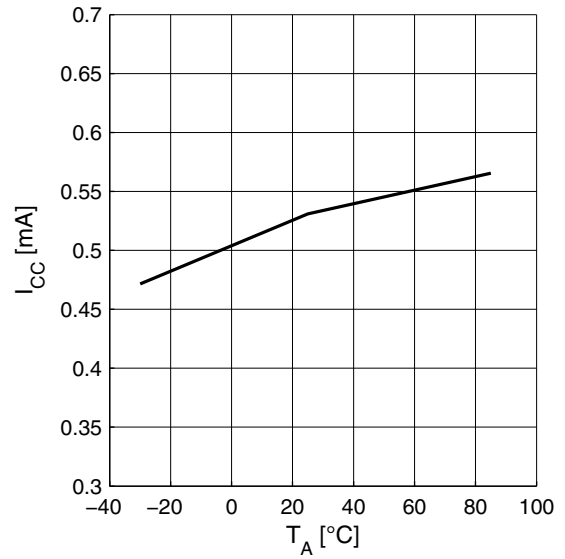
### 2.21 Measured Performance Band 7 Application Low Gain Mode vs. Temperature

$T_A = 25\text{ }^\circ\text{C}$ ,  $V_{CC} = 2.8\text{ V}$ ,  $V_{GS} = 0\text{ V}$ ,  $V_{EN} = 2.8\text{ V}$ ,  $f = 2650\text{ MHz}$

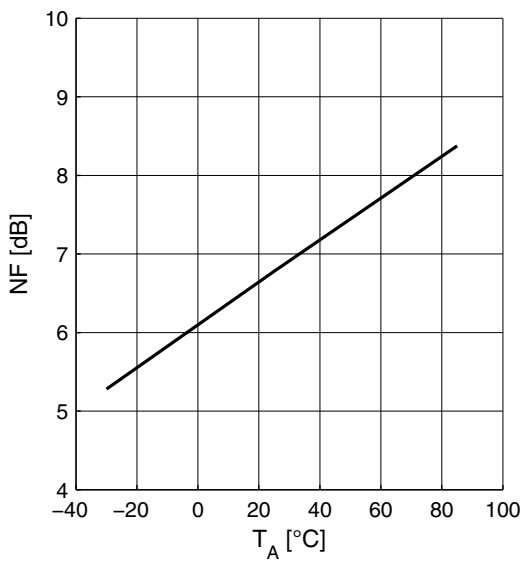
Power Gain  $|S_{21}| = f(T_A)$



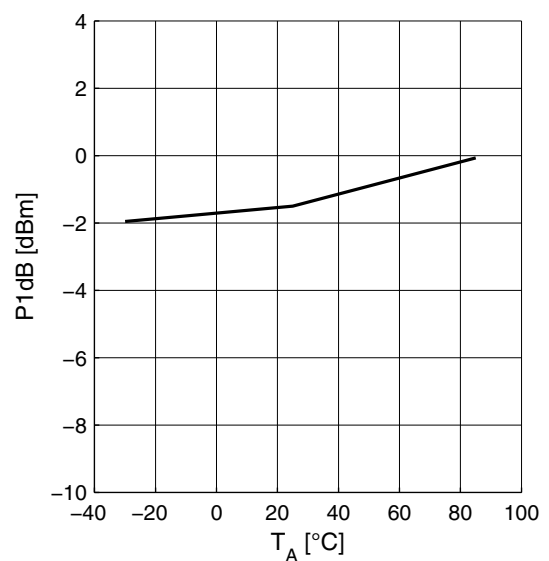
Supply Current  $I_{CC} = f(T_A)$



Noise Figure  $NF = f(T_A)$

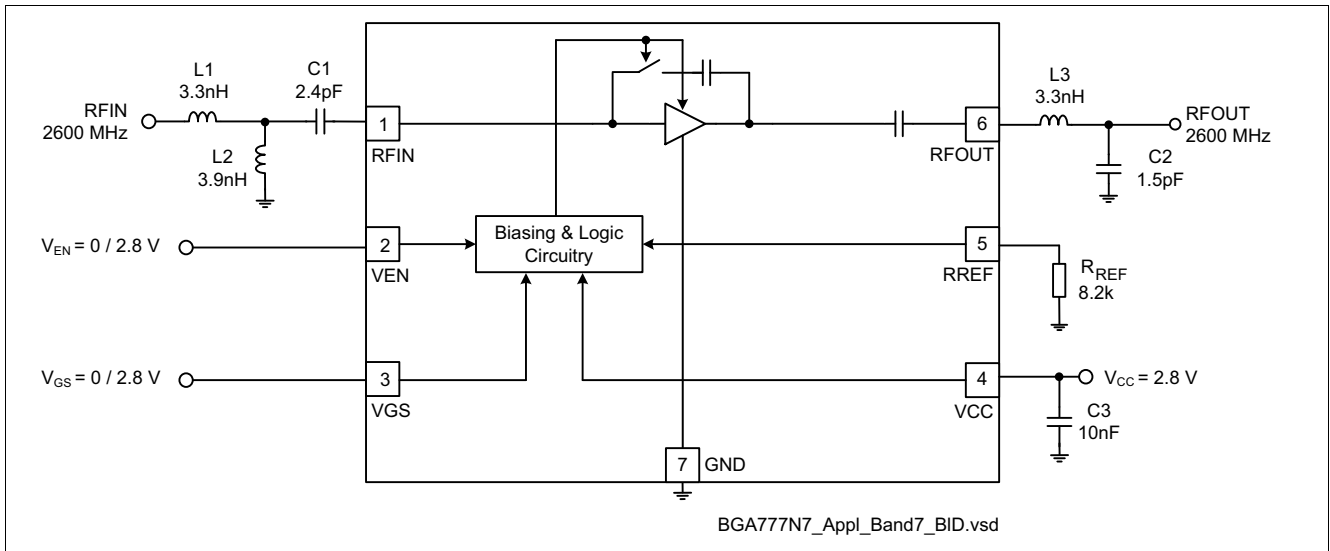


Input Compression  $P1dB = f(T_A)$



### 3 Application Circuit and Block Diagram

#### 3.1 UMTS Band 7 Application Circuit Schematic



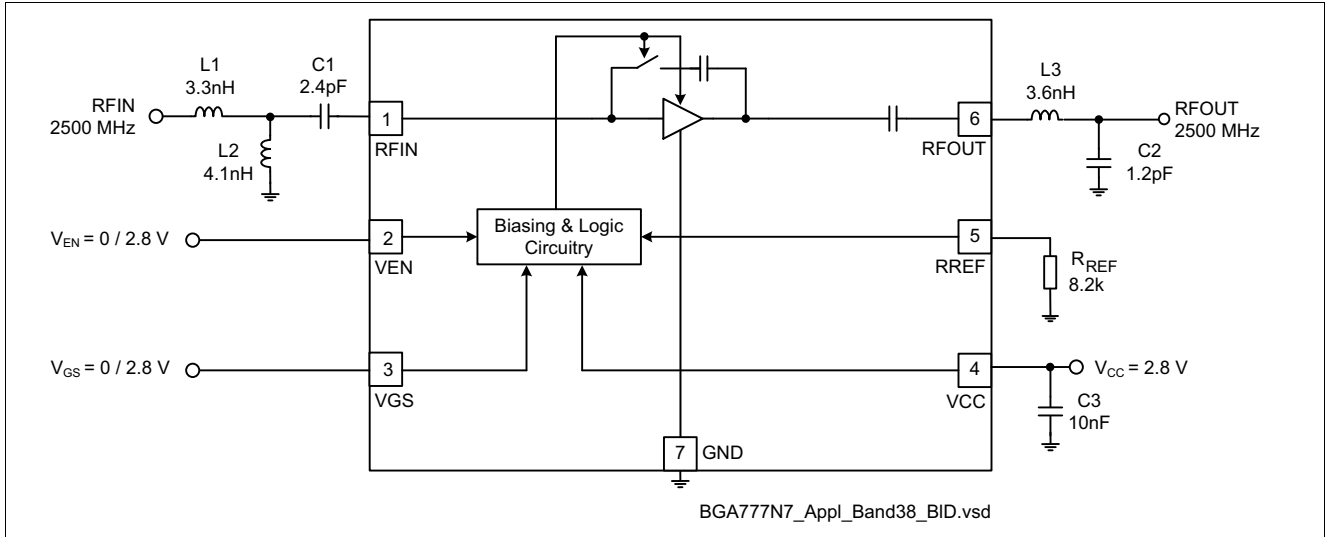
**Figure 2 Application Circuit with Chip Outline (Top View)**

*Note: Package paddle (Pin 0) has to be RF grounded.*

**Table 16 Bill of Materials**

Part Number	Part Type	Manufacturer	Size	Comment
L1 ... L3	Chip inductor	Various	0402	Wirewound, $Q \approx 50$
C1 ... C3	Chip capacitor	Various	0402	
R <sub>REF</sub>	Chip resistor	Various	0402	

### 3.2 UMTS Band 38 Application Circuit Schematic



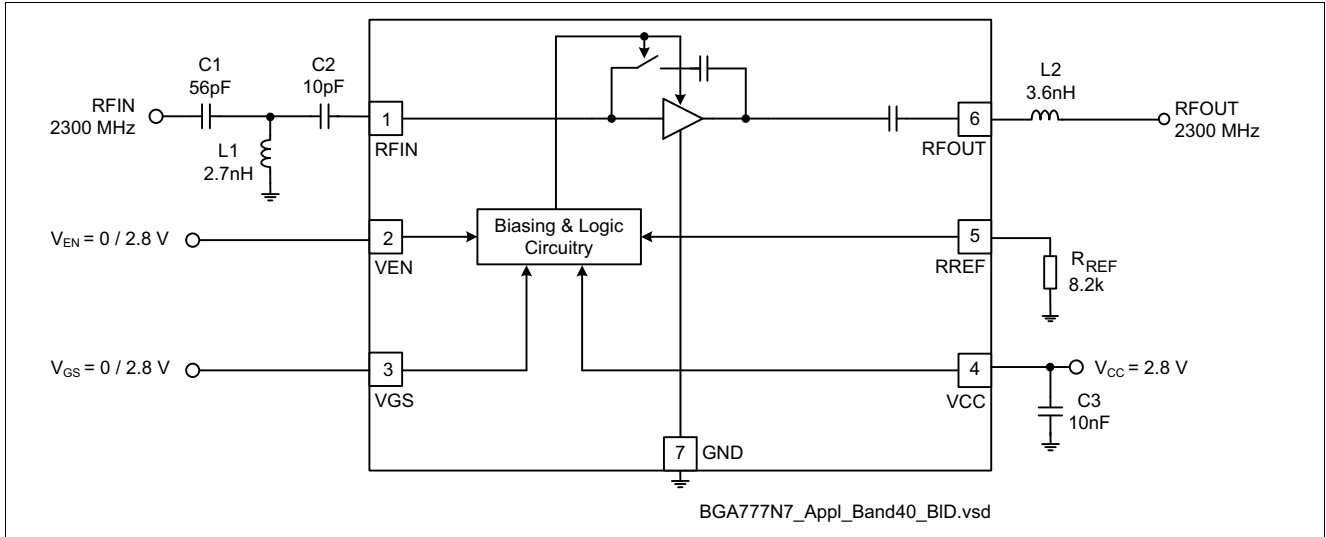
**Figure 3 Application Circuit with Chip Outline (Top View)**

*Note: Package paddle (Pin 0) has to be RF grounded.*

**Table 17 Bill of Materials**

Part Number	Part Type	Manufacturer	Size	Comment
L1 ... L3	Chip inductor	Various	0402	Wirewound, $Q \approx 50$
C1 ... C3	Chip capacitor	Various	0402	
R <sub>REF</sub>	Chip resistor	Various	0402	

### 3.3 UMTS Band 40 Application Circuit Schematic



**Figure 4 Application Circuit with Chip Outline (Top View)**

Note: Package paddle (Pin 0) has to be RF grounded.

**Table 18 Bill of Materials**

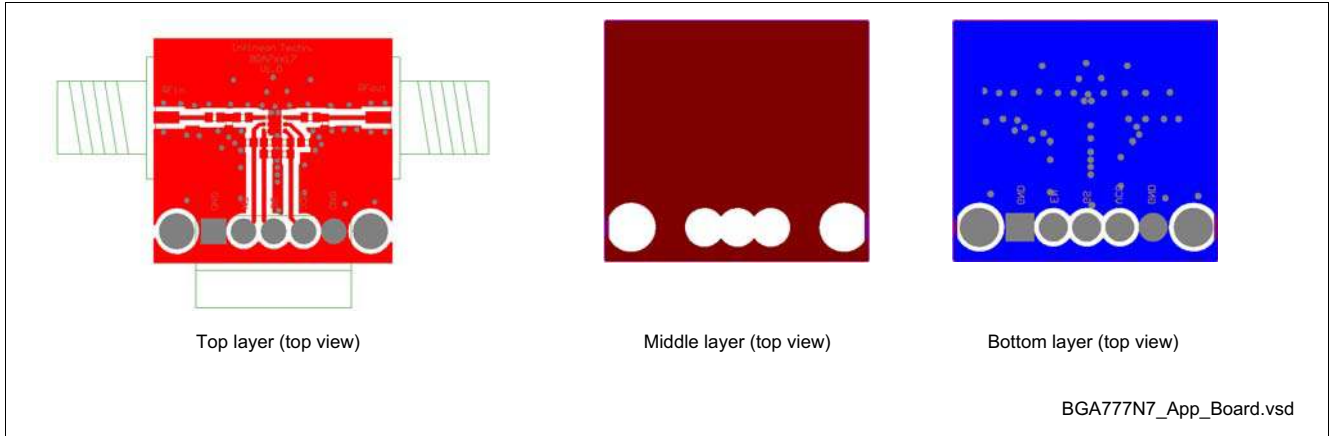
Part Number	Part Type	Manufacturer	Size	Comment
L1 ... L2	Chip inductor	Various	0402	Wirewound, $Q \approx 50$
C1 ... C3	Chip capacitor	Various	0402	
R <sub>REF</sub>	Chip resistor	Various	0402	

### 3.4 Pin Definition

**Table 19 Pin Definition and Function**

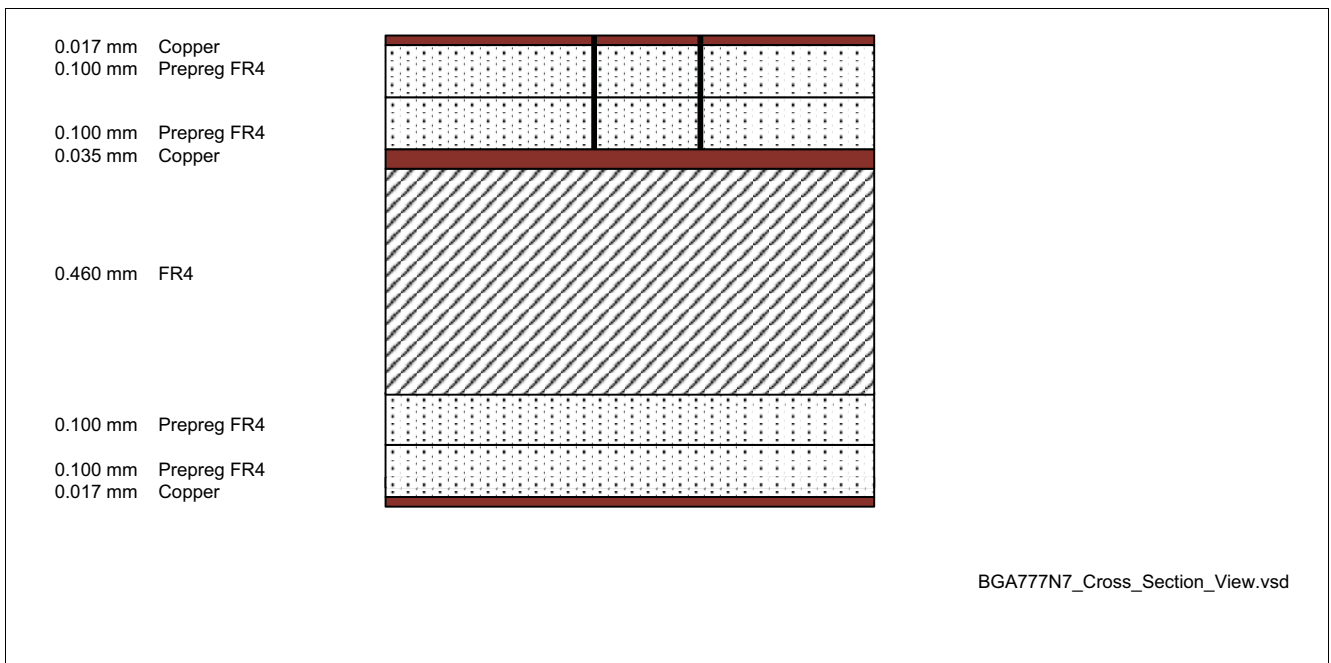
Pin Number	Symbol	Function
1	RFIN	LNA input (2600 MHz)
2	VEN	Band select control
3	VGS	Gain step control
4	VCC	Supply voltage
5	R <sub>REF</sub>	Bias current reference resistor (high gain mode)
6	RFOUT	LNA output (2600 MHz)
7	GND	Package paddle; ground connection for LNA and control circuitry

### 3.5 Application Board

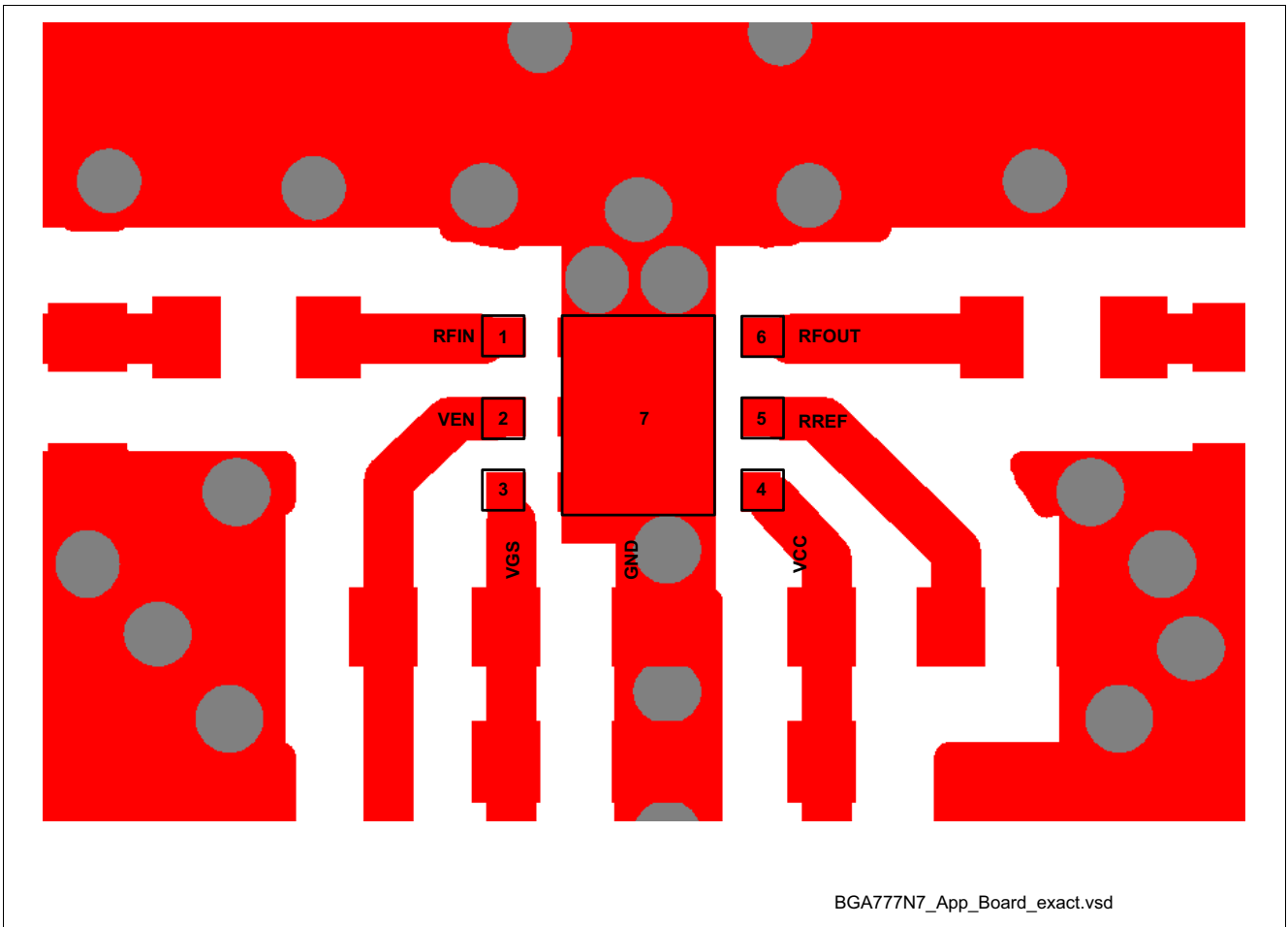


**Figure 5 Application Board Layout on 3-Layer FR4**

*Note: Top layer thickness: 0.2 mm, bottom layer thickness: 0.8 mm, 17  $\mu$ m Cu metallization, gold plated. Board size: 21 x 19mm.*



**Figure 6 Cross-Section View of Application Board**



**Figure 7** Detail of Application Board Layout

*Note: In order to achieve the same performance as given in this datasheet please follow the suggested PCB-layout as closely as possible. The position of the GND via is critical for RF performance.*



## 4 Physical Characteristics

### 4.1 Package Footprint

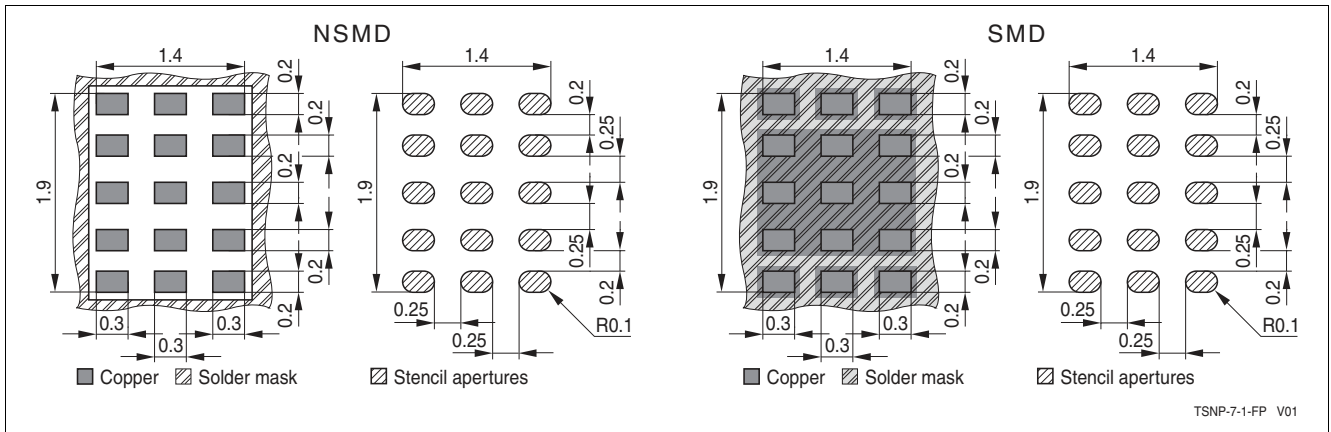


Figure 8 Footprint Recommendation 1 for the TSNP-7-1 Package

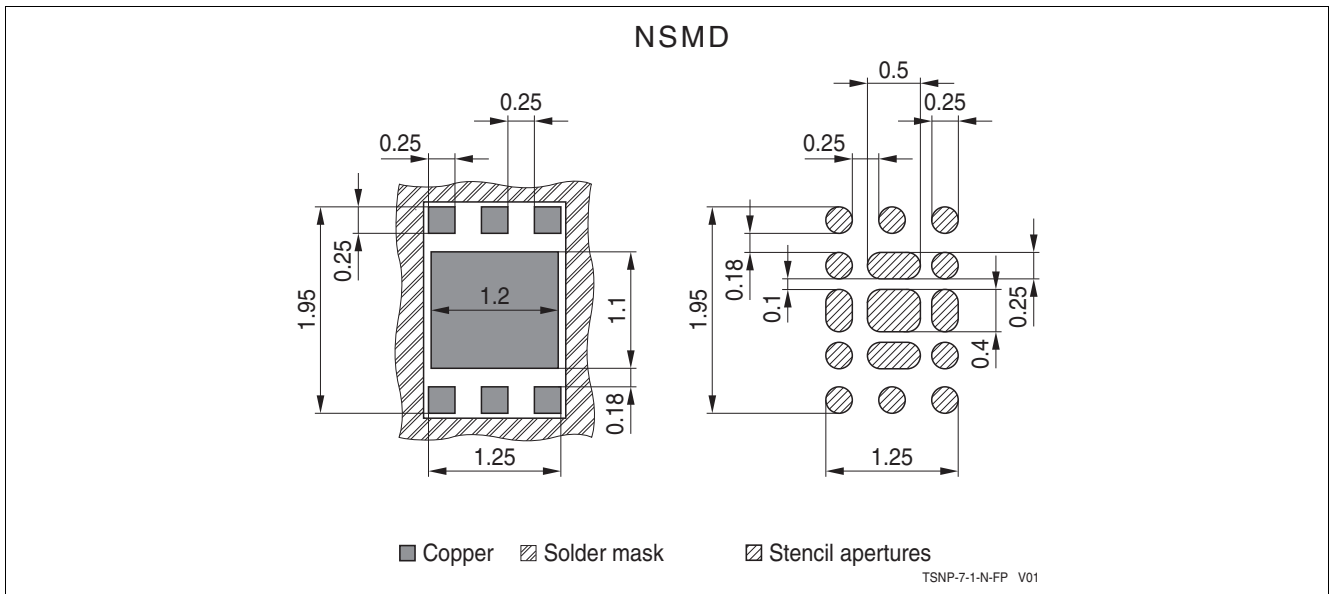


Figure 9 Footprint Recommendation 2 for the TSNP-7-1 Package

## 4.2 Package Dimensions

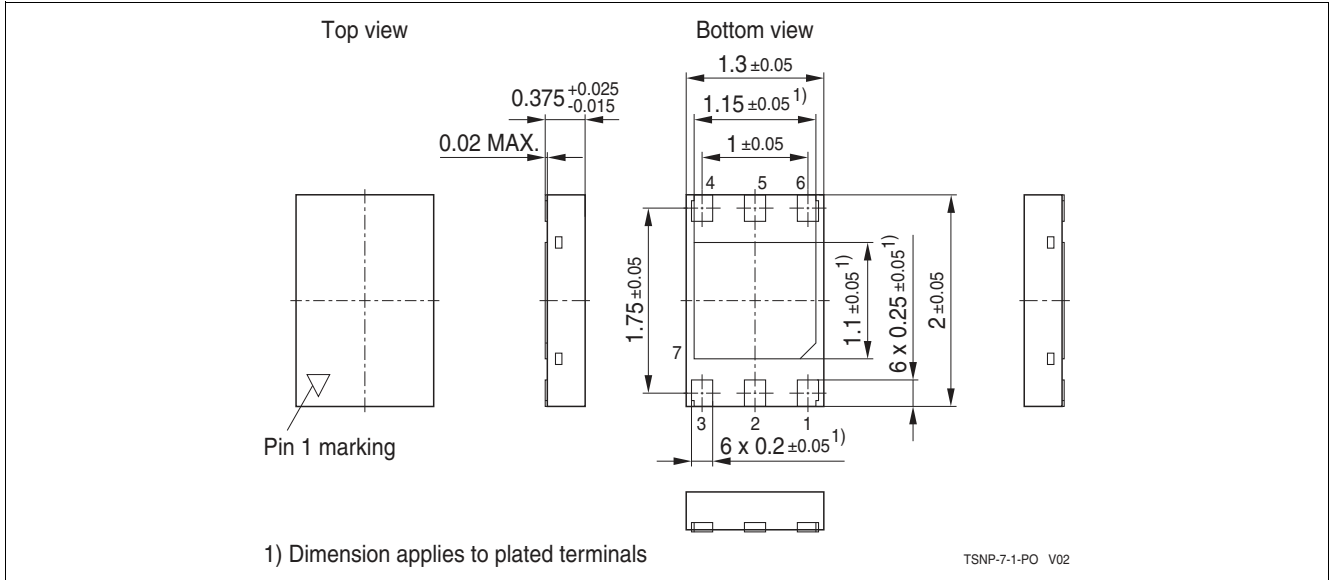


Figure 10 Package Outline (top, side and bottom view)

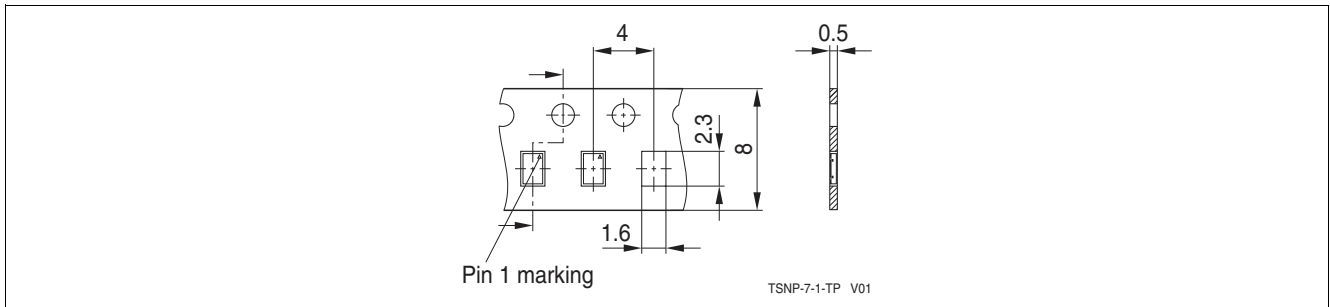


Figure 11 Tape & Reel Dimensions

## 4.3 Product Marking Pattern

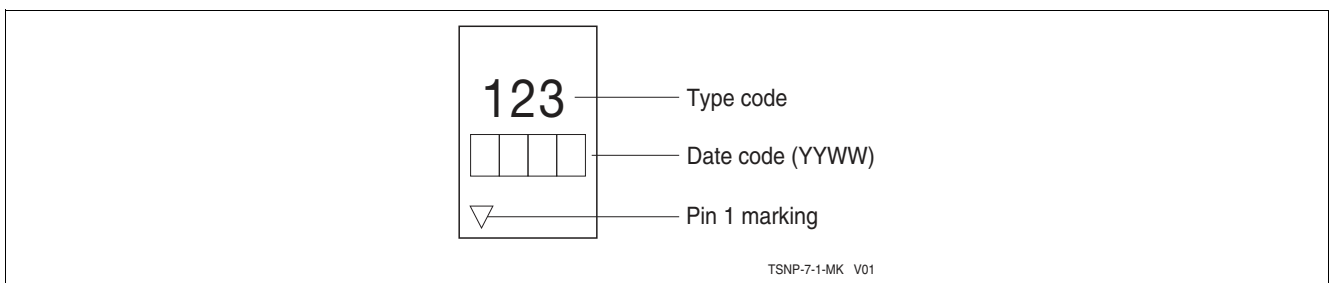


Figure 12 Marking Pattern (top view)

[www.infineon.com](http://www.infineon.com)

Published by Infineon Technologies AG