

Datasheet



Sure Cross® Wireless Q45 Sensors combine the best of Banner's flexible Q45 sensor family with its reliable, field-proven, Sure Cross wireless architecture to solve new classes of applications limited only by the user's imagination. Containing a variety of sensor models, a radio, and an internal battery supply, this product line is truly plug-and-play.

The Q45 All-in-One D-cell Photoelectric Sensor Nodes are compact, industrial, battery-powered photoelectric sensors that can be used to wirelessly transmit presence/absence inputs and a totalized count to a wireless Gateway/Controller. The Photoelectric Sensor Nodes come in two sensing modes: Diffuse and Retroreflective.

- Diffuse mode All-in-One Sensor Nodes detect an object when it reflects the sensor's transmitted light energy back to the sensor without the need for a reflector.
- Retroreflective mode All-in-One Sensor Nodes require a reflector and detect an object when the reflected light energy is blocked.

Benefits

- Powerful device that delivers factory automation and IIoT solutions for many applications including but not limited to:
 - Presence/absence
 - Pallet completion
 - Asynchronous counter totalizing up to 960 parts/minute
 - Part rate monitoring and Overall Equipment Effectiveness (OEE)
 - Machine status monitoring (jams, diverts, etc.) and cycle count
 - Rotational speed
- **Easy installation**—Battery-powered for peel-and-stick functionality with a four-year battery life capability; no need for power or control wires
- **Reduce complexity**—Machine or process reconfiguration made easier; great for retrofit applications and remote locations where implementing a wired solution would be difficult, impractical, or cost prohibitive

<p>Q45DD</p> 	<ul style="list-style-type: none"> • Combines a diffuse-mode or retroreflective-mode photoelectric sensor, a wireless Node, and an internal battery to make it easy to install • DIP switches for user configuration • Diagnostics allow user-defined output settings in the unlikely event of lost RF signal • Frequency Hopping Spread Spectrum (FHSS) technology ensures reliable data delivery • Selectable transmit power levels of 250 mW or 1 Watt for 900 MHz models and 65 mW for 2.4 GHz models 	<p>Q45LPD</p> 
--	--	---

Models

Models	Frequency	Sensing Mode	Sensing Range
DX80N2Q45DD	2.4 GHz ISM Band	Diffuse	300 mm (12 in)
DX80N9Q45DD	900 MHz ISM Band		
DX80N2Q45LPD	2.4 GHz ISM Band	Retroreflective	0.15 m (6 in) to 6 m (20 ft) ⁽¹⁾
DX80N9Q45LPD	900 MHz ISM Band		

To order an integrated battery model without the battery, add an **NB** to the model number (for example, **DX80N2Q45DD NB**). If you purchase a model without the battery, Banner Engineering recommends battery model **BWA-BATT-011**.

Storage Mode

While in **storage mode**, the device's radio does not operate, to conserve the battery. To put any device into storage mode, press and hold the binding button for five seconds. The device is in storage mode when the LEDs stop blinking. To wake the device, press and hold the binding button (inside the housing on the radio board) for five seconds.

⁽¹⁾ Performance is specified using the model **BRT-3** three-inch reflector.



Configuration Instructions

Binding Button and LEDs



The image shows the internal components of the sensor node. A binding button is labeled '1'. Three LEDs are labeled '2-4': an amber LED on the left, a green LED in the middle, and a red LED on the right. An excess gain potentiometer is labeled '5', and four DIP switches are labeled '6'.

1. Binding button
2. Amber LED (left LED) for Alignment or Test Mode. Indicates sensor function (optical sensor models). The amber LED is not used during normal operation.
3. Green LED (middle LED) (flashing) indicates a good radio link with the Gateway.
4. Red LED (right LED) (flashing) indicates a radio link error with the Gateway.
5. Excess gain potentiometer. Turn clockwise to increase the gain.
6. DIP switches

DIP Switches

The DIP switches are in the OFF position, by default. To turn a DIP switch on, push the switch toward the battery pack. DIP switches one through four are numbered from left to right.

After making any changes to any DIP switch position, reboot the Q45 by triple-clicking the binding button, waiting a second, then double-clicking the binding button.

The factory default sample rate is 62.5 ms with change of state reporting.

Settings	DIP Switch			
	1	2	3	4
900 MHz Transmit Power Level: 1 Watt (30 dBm) (default)	OFF *			
900 MHz Transmit Power Level: 250 mW (24 dBm) (DX80 Compatibility Mode)	ON			
No Counter, 62.5 ms Sample Rate/Change of State Reporting (default)		OFF *	OFF *	OFF *
Counter Enabled, 62.5 ms Sample Rate/60 s Report Rate		OFF	OFF	ON
Counter Enabled, 62.5 ms Sample Rate/User-Defined Report Rate		OFF	ON	OFF
Counter Enabled, 31.25 ms Sample Rate/60 s Report Rate		OFF	ON	ON
Counter Enabled, 31.25 ms Sample Rate/User-Defined Report Rate		ON	OFF	OFF
Counter Enabled, 62.5 ms Sample Rate/60 s Report Rate and Change of State Reporting on Sensor IN 1		ON	OFF	ON
Counter Enabled, 62.5 ms Sample Rate/User-defined Report Rate and Change of State Reporting on Sensor IN 1		ON	ON	OFF
Software Configured (User-Defined)		ON	ON	ON

For user-defined (configured using the DX80 Performance Configuration Software) DIP switch selections, the counter's report rate is defined by the report rate of Sensor IN 1 and can be modified for a custom report rate.

Transmit Power Levels

The 900 MHz radios transmit at 1 Watt (30 dBm) or 250 mW (24 dBm). The 250 mW mode reduces the radio's range but improves the battery life in short-range applications. For 2.4 GHz models, this DIP switch is disabled. The transmit power for 2.4 GHz is fixed at about 65 mW EIRP (18 dBm).

Sample and Report Rates

The sample interval, or rate, defines how often the Sure Cross device samples the input. For battery-powered applications, setting a slower rate extends the battery life.

The report rate defines how often the Node communicates the I/O status to the Gateway. For battery-powered applications, setting the report rate to a slower rate extends the battery life.

Apply Power to the Q45 D-Cell Models

Follow these instructions to install or replace the lithium D-cell batteries.

As with all batteries, these are fire, explosion, and severe burn hazards. Do not burn or expose them to high temperatures. Do not recharge, crush, disassemble, or expose the contents to water. Properly dispose of used batteries according to local regulations by taking them to a hazardous waste collection site, an e-waste disposal center, or another facility qualified to accept lithium batteries.

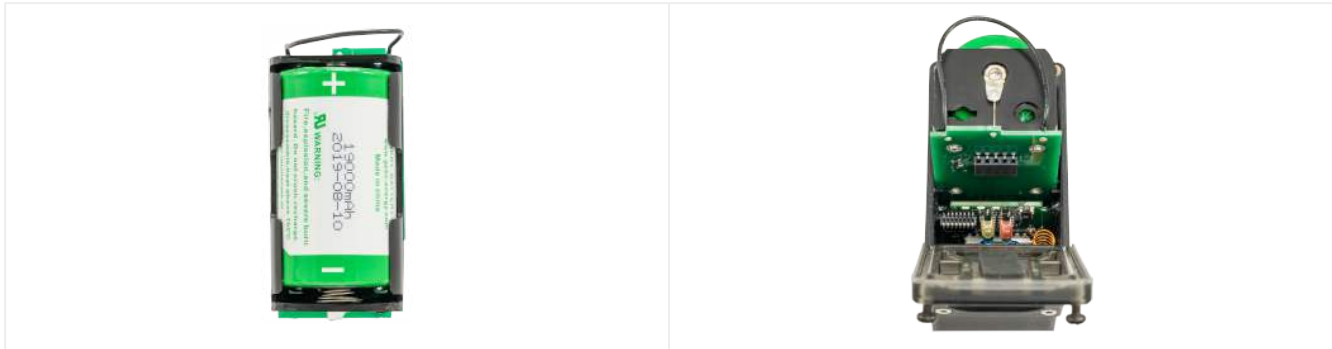

1. Loosen the clamp plate with a small Phillips screwdriver and lift the cover.
2. Use the black pull wire to pull the battery board out of the Q45 housing.
3. If applicable, remove the discharged battery.
4. Install the new battery. Use Banner's **BWA-BATT-011** replacement battery or an equivalent 3.6 V D-cell lithium battery, such as Xeno's XL-205F.
5. Verify the battery's positive and negative terminals align to the positive and negative terminals of the battery holder mounted within the case. Caution: There is a risk of explosion if the battery is replaced incorrectly.
6. Slide the board containing the new battery back into the Q45 housing.
7. Close the cover and gently tighten the clamp plate with the small Phillips screwdriver.

Bind to the Gateway and Assign the Node Address

Before beginning the binding procedure, apply power to all the devices. Separate the devices by two meters when running the binding procedure. Put only one Gateway into binding at a time to prevent binding to the wrong Gateway.

1. On the Gateway: Enter binding mode.
 - For housed DX80 Gateways, triple-click button 2 on the Gateway. Both LEDs flash red.
 - For Gateway board modules, triple-click the button. The green and red LED flashes.
2. Assign the Q45 a Node address using the Gateway's rotary dials. Use the left rotary dial for the left digit and the right rotary dial for the right digit. For example, to assign your Q45 to Node 10, set the Gateway's left dial to 1 and the right dial to 0. Valid Node addresses are 01 through 47.
3. On the Q45: Loosen the clamp plate on the top of the Q45 and lift the cover.
4. Enter binding mode on the Q45 by triple-clicking the Q45's button. The red and green LEDs flash alternately and the sensor searches for a Gateway in binding mode. After the Q45 is bound, the LEDs stay solid momentarily, then they flash together four times. The Q45 exits binding mode.
5. Label the sensor with the Q45's Node address number for future reference.
6. Repeat steps 2 through 5 for as many Q45s as are needed for your network.
7. On the Gateway: After binding all Q45s, exit binding mode.
 - For housed DX80 Gateways, double-click button 2.
 - For board-level DX80 Gateways, double-click the button.

For Gateways with single-line LCDs: After binding your Q45 to the Gateway, make note of the binding code displayed under the Gateway's *DVCFG menu, XADR submenu on the LCD. Knowing the binding code prevents having to re-bind all Q45s if your Gateway is ever replaced.

Holding Registers

I/O #	Modbus Holding Register		I/O Type	I/O Range		Holding Register Representation	
	Gateway	Any Node		Min. Value	Max. Value	Min. (Dec.)	Max. (Dec.)
1	1	1 + (Node# × 16)	Sensor State	0	1	0	1
2	2	2 + (Node# × 16)	Reserved				
3	3	3 + (Node# × 16)	Counter High Word	0	65535	0	65535
4	4	4 + (Node# × 16)	Counter Low Word	0	65535	0	65535
7	7	7 + (Node# × 16)	Reserved				

Continued on page 4

Continued from page 3

I/O #	Modbus Holding Register		I/O Type	I/O Range		Holding Register Representation	
	Gateway	Any Node		Min. Value	Max. Value	Min. (Dec.)	Max. (Dec.)
8	8	8 + (Node# × 16)	Device Message				
14	14	14 + (Node# × 16)	Clear Counter	0	1	0	1
15	15	15 + (Node# × 16)	Control Message				
16	16	16 + (Node# × 16)	Reserved				

Sensor State—A value of 0 indicates the sensor beam is not blocked. A value of 1 indicates the sensor beam is blocked.

Using the Event Counter

The counter "counts" when the input is on for a minimum of the sample rate. The counter input is off when the input is off for a minimum of the sample rate.

For example, if your sample rate is set to 62.5 ms, the counter input is on, and therefore counts, when the input is on for at least 62.5 ms. If the input is not on for 62.5 ms, the counter does not increment.

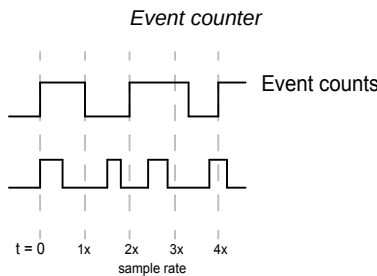

To clear the counter when you are not using a host-controlled system, write a 1 to the Node's output register 14. Clearing the counter requires that this register goes from a 0 to a 1. If there is already a 1 in the register, first write a 0, then write the 1. You can use the Gateway IO mapping to map an input, such as a button, to clear the counter value.

To clear the counter when you are using a host-controlled system, send a control message to Node register 15. Control messages on Node register 15 are acknowledged with the same value echoed to Node register 7.

1. Write 5388 (0x150C) to Node register 15.
2. Read Node register 7 until it echoes the Node register 15 value.

Principles of Operation

The Wireless Q45 Sensor enters and remains in optical alignment mode for 15 minutes after the binding button is pushed, after the Q45 exits binding mode, or after the Q45 is powered up (battery replaced).

After 15 minutes, the Q45 automatically exits optical alignment mode and begins normal operation. After the sensor begins normal operation, the amber sensor state LED is inactive. To exit alignment mode earlier, click the binding button five times.

Diffuse Sensing Mode (Q45DD)

In diffuse-mode sensing, light emitted from the sensor strikes the surface of the object to be detected and is diffused back, sending some light back to the receiver, which is housed with the emitter.

With a diffuse-mode sensor, the object is detected when the object reflects the sensor's transmitted light energy back to the sensor. During optical alignment mode, the sensor's amber LED lights up whenever the sensor detects the reflected beam.

Retroreflective Sensing Mode (Q45LPD)

In retroreflective-mode sensing, light emitted from the sensor strikes a reflector and is reflected back to the receiver, which is housed with the emitter.

With a retroreflective-mode sensor, the object is detected when it blocks the light path to the reflector. During optical alignment mode, the sensor's beam is bright enough to see when aligned with a reflector or target, making alignment and mounting easier to accomplish. During this alignment mode, the sensor's amber LED lights up when the sensor detects the reflected beam (no object present).

Specifications

Specifications for the Performance Radio with Internal Antenna

Radio Range

900 MHz, 1 Watt: Up to 3.2 km (2 miles) with line of sight (internal antenna)

2.4 GHz, 65 mW: Up to 1000 m (3280 ft) with line of sight (internal antenna)

Range depends on the environment and decreases significantly without line of sight. Always verify your wireless network's range by performing a Site Survey.

Radio Transmit Power

900 MHz, 1 Watt: 30 dBm (1 W) conducted (up to 36 dBm EIRP)

2.4 GHz, 65 mW: 18 dBm (65 mW) conducted, less than or equal to 20 dBm (100 mW) EIRP

Antenna Minimum Separation Distance

900 MHz, 150 mW and 250 mW: 2 m (6 ft)

900 MHz, 1 Watt: 4.57 m (15 ft)

2.4 GHz, 65 mW: 0.3 m (1 ft)

Spread Spectrum Technology

FHSS (Frequency Hopping Spread Spectrum)

Link Timeout (Performance)

Gateway: Configurable via User Configuration Software

Node: Defined by Gateway

900 MHz Compliance (SX7023 Radio Module)

Radio module is indicated by the product label marking

Contains FCC ID: UE3SX7023EXT: FCC Part 15, Subpart C, 15.247

Contains IC: 7044A-SX7023EXT

900 MHz Compliance (RM1809 Radio Module)

Radio module is indicated by the product label marking
Contains FCC ID: UE3RM1809: FCC Part 15, Subpart C, 15.247

Contains IC: 7044A-RM1809

IFT: RCPBARM13-2283



2.4 GHz Compliance (DX80-2400 Radio Module)

Radio module is indicated by the product label marking

Contains FCC ID: UE300DX80-2400: FCC Part 15, Subpart C, 15.247

Radio Equipment Directive (RED) 2014/53/EU

Contains IC: 7044A-DX8024

ANATEL: 15966-21-04042



2.4 GHz Compliance (SX243 Radio Module)

Radio module is indicated by the product label marking

Contains FCC ID: UE3SX243: FCC Part 15, Subpart C, 15.247

Radio Equipment Directive (RED) 2014/53/EU

ETSI/EN: EN 300 328 V2.2.2 (2019-07) [RED HarmStds]

Contains IC: 7044A-SX243

ANATEL: 03737-22-04042



Specifications for the Q45DD and LPD Sensors

Sensing Range

Diffuse models: 300 mm (12 in)

Retroreflective models: 0.15 m (6 in) to 6 m (20 ft)

Report Rate

On Change of State

Default Sample Rate

62.5 milliseconds

Adjustments

Multi-turn sensitivity control (allows precise sensitivity setting - turn clockwise to increase gain).

Indicators

Red and green LEDs (radio function); amber LED (only for alignment mode)

Construction

Molded reinforced thermoplastic polyester housing, oring-sealed transparent Lexan® cover, molded acrylic lenses, and stainless steel hardware. Designed to withstand 1200 psi washdown.

Battery Life (Typical for 900 MHz, 1 Watt)

With no counter and change-of-state reporting of greater than 5 minutes: 7.3 years

With no counter and change-of-state reporting of about 30 s: 5.6 years

With a counter set to 62.5 ms sample rate and 60 s report rate: 5.2 years

With a counter set to 31.25 ms sample rate and 60 s report rate: 3.5 year

Battery Life (Typical for 2.4 GHz)

With no counter and change-of-state reporting of greater than 5 minutes: 9.1 years

With no counter and change-of-state reporting of about 30 s: 8.7 years

With a counter set to 62.5 ms sample rate and 60 s report rate: 8 years

With a counter set to 31.25 ms sample rate and 60 s report rate: 4.2 year

Certifications



Banner Engineering BV
 Park Lane, Culliganlaan 2F bus 3
 1831 Diegem, BELGIUM



Turck Banner LTD Blenheim House
 Blenheim Court
 Wickford, Essex SS11 8YT
 GREAT BRITAIN

(CE/UKCA approval only applies to 2.4 GHz models)

Q45 Environmental Specifications

Operating Conditions

-40 °C to +70 °C (-40 °F to +158 °F); 90% at +50 °C maximum relative humidity (non-condensing)
 Radiated Immunity: 10 V/m (EN 61000-4-3)

Environmental Rating

NEMA 6P
 IP67

Operating the devices at the maximum operating conditions for extended periods can shorten the life of the device.

Battery Life for the Q45DD and LPD Models

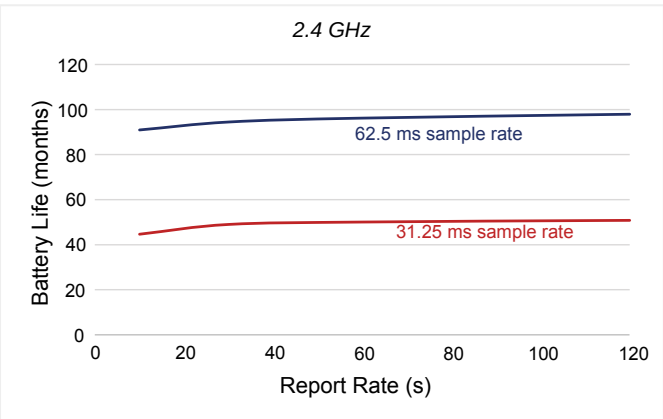
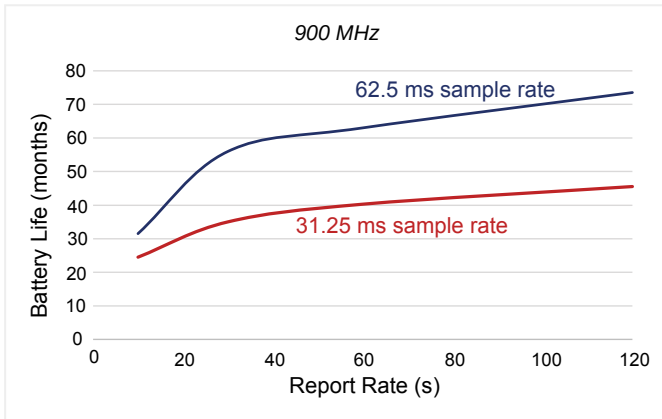

Performance Curves for the Q45DD and LPD Models

For the diffuse models, performance curves are based on a 90% reflectance white test card.

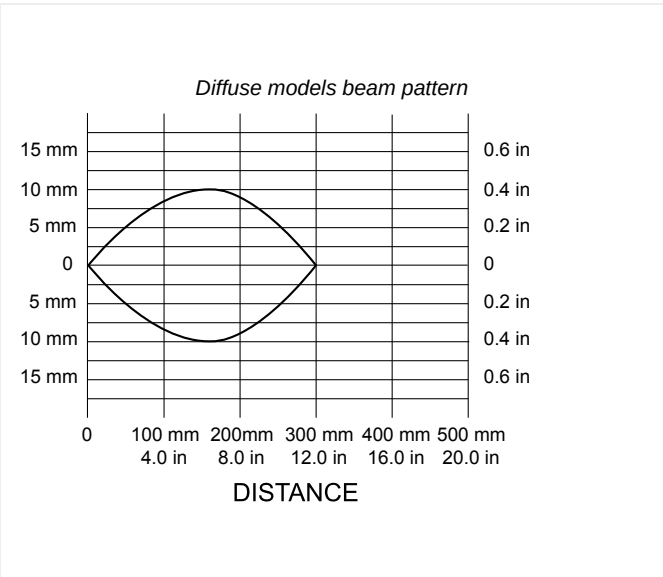
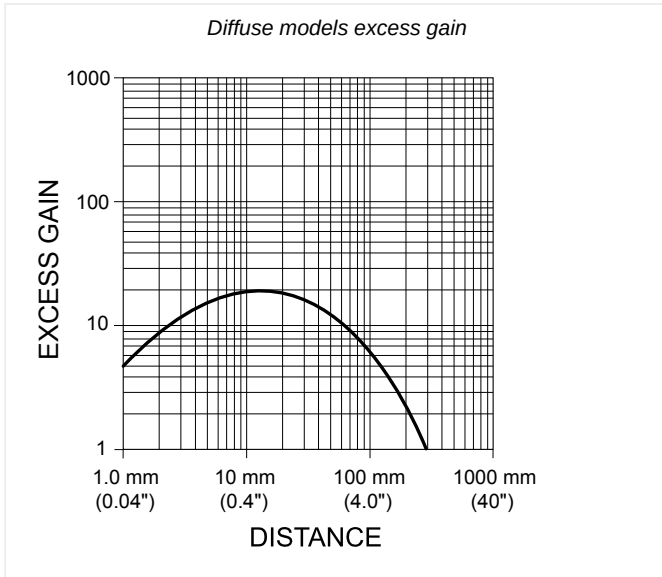

Continued on page 7

Continued from page 6

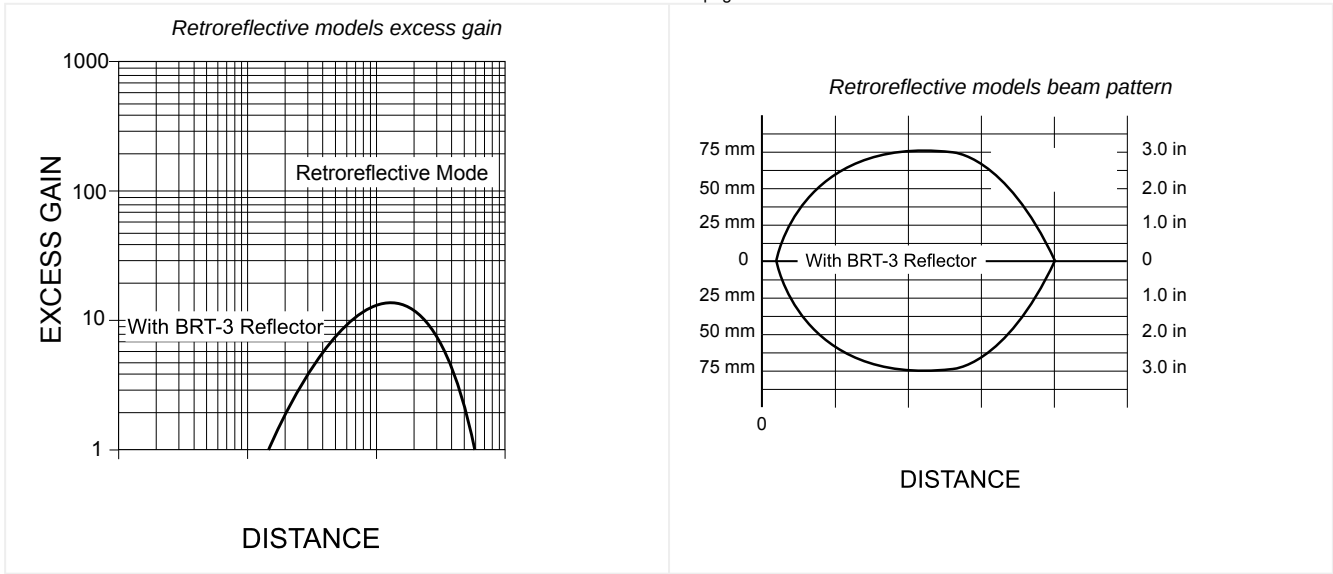

Dimensions for the Q45DD and LPD Models

Dimensions for the Q45DD and LPD models

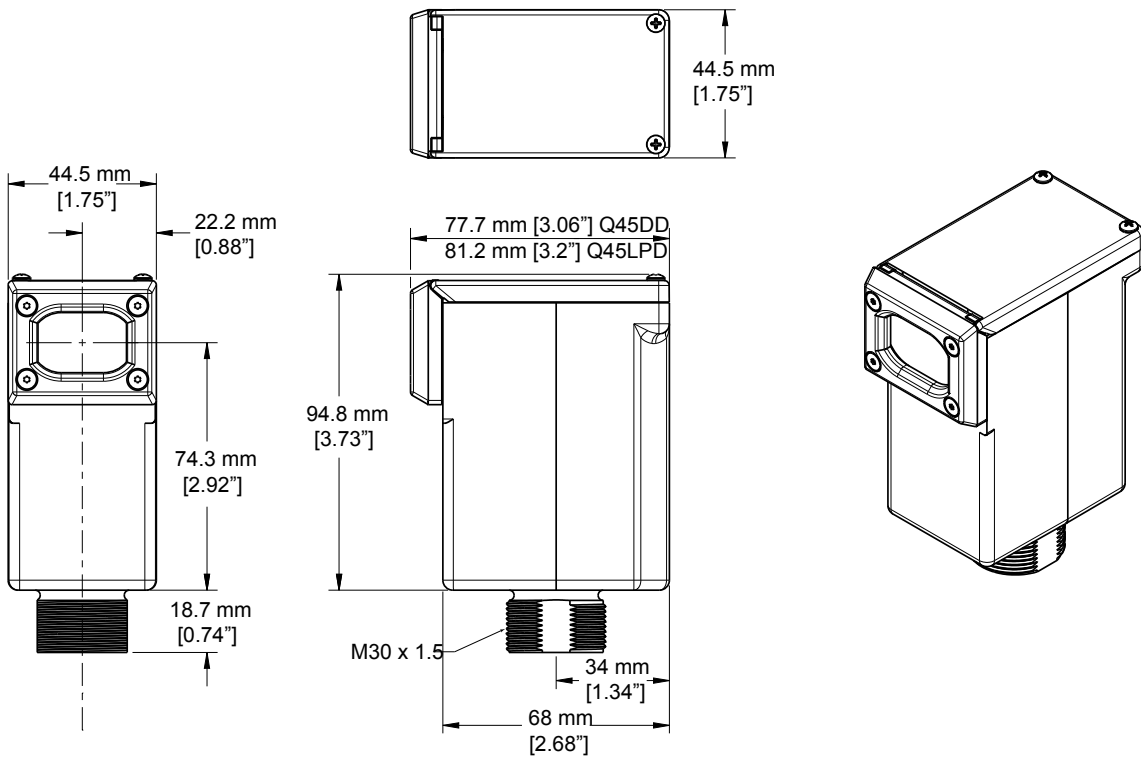

Accessories

Replacement Batteries

<p>BWA-BATT-011</p> <ul style="list-style-type: none"> • 3.6 V Lithium D cell for non-hazardous locations only • 19000 mAH • One battery 	
--	---

Brackets for the Q45DD and LPD Models

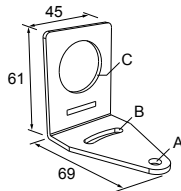
<p>SMB30A</p> <ul style="list-style-type: none"> • Right-angle bracket with curved slot for versatile orientation • Clearance for M6 (¼ in) hardware • Mounting hole for 30 mm sensor • 12-ga. stainless steel 	
---	---

Hole center spacing: A to B=40
Hole size: A=∅ 6.3, B= 27.1 x 6.3, C=∅ 30.5

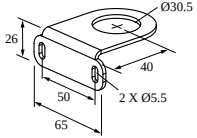
<p>LMB30LP</p> <ul style="list-style-type: none"> • Low profile • 30 mm mounting hole • 300 series stainless steel 	
--	--

Reflectors for the Q45 LPD Model

These reflectors are required for the retroreflective model only.

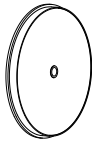
<p>BRT-3</p> <ul style="list-style-type: none"> • Round, acrylic target • Reflectivity Factor: 1.0 • Temperature: -20 °C to +60 °C (-4 °F to +140 °F) • Optional brackets are available • Size: 84 mm diameter • Mounting Hole: 4.8 mm diameter 	
--	---

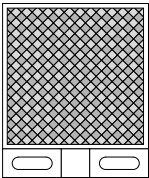
<p>BRT-2X2LVC</p> <ul style="list-style-type: none"> • Square, acrylic target • Reflectivity Factor: 1.0 • Temperature: -20 °C to +60 °C (-4 °F to +140 °F) • Optional brackets are available • Approximate size: 51 mm x 51 mm 	
---	---

Warnings

Exporting Sure Cross® Radios. It is our intent to fully comply with all national and regional regulations regarding radio frequency emissions. **Customers who want to re-export this product to a country other than that to which it was sold must ensure the device is approved in the destination country.** The Sure Cross wireless products were certified for use in these countries using the antenna that ships with the product. When using other antennas, verify you are not exceeding the transmit power levels allowed by local governing agencies. This device has been designed to operate with the antennas listed on Banner Engineering's website and having a maximum gain of 9 dBm. Antennas not included in this list or having a gain greater than 9 dBm are strictly prohibited for use with this device. The required antenna impedance is 50 ohms. To reduce potential radio interference to other users, the antenna type and its gain should be so chosen such that the equivalent isotropically radiated power (EIRP) is not more than that permitted for successful communication. Consult with Banner Engineering Corp. if the destination country is not on this list.

IMPORTANT: Please download the complete Wireless Q45 Sensor Node technical documentation, available in multiple languages, from www.bannerengineering.com for details on the proper use, applications, Warnings, and installation instructions of this device.

IMPORTANT: Por favor descargue desde www.bannerengineering.com toda la documentación técnica de los Wireless Q45 Sensor Node, disponibles en múltiples idiomas, para detalles del uso adecuado, aplicaciones, advertencias, y las instrucciones de instalación de estos dispositivos.

IMPORTANT: Veuillez télécharger la documentation technique complète des Wireless Q45 Sensor Node sur notre site www.bannerengineering.com pour les détails sur leur utilisation correcte, les applications, les notes de sécurité et les instructions de montage.

WARNING:



- **Do not use this device for personnel protection**
- Using this device for personnel protection could result in serious injury or death.
- This device does not include the self-checking redundant circuitry necessary to allow its use in personnel safety applications. A device failure or malfunction can cause either an energized (on) or de-energized (off) output condition.

IMPORTANT:

- **Electrostatic discharge (ESD) sensitive device**
- ESD can damage the device. Damage from inappropriate handling is not covered by warranty.
- Use proper handling procedures to prevent ESD damage. Proper handling procedures include leaving devices in their anti-static packaging until ready for use; wearing anti-static wrist straps; and assembling units on a grounded, static-dissipative surface.

Banner Engineering Corp Limited Warranty

Banner Engineering Corp. warrants its products to be free from defects in material and workmanship for one year following the date of shipment. Banner Engineering Corp. will repair or replace, free of charge, any product of its manufacture which, at the time it is returned to the factory, is found to have been defective during the warranty period. This warranty does not cover damage or liability for misuse, abuse, or the improper application or installation of the Banner product.

THIS LIMITED WARRANTY IS EXCLUSIVE AND IN LIEU OF ALL OTHER WARRANTIES WHETHER EXPRESS OR IMPLIED (INCLUDING, WITHOUT LIMITATION, ANY WARRANTY OF MERCHANTABILITY OR FITNESS FOR A PARTICULAR PURPOSE), AND WHETHER ARISING UNDER COURSE OF PERFORMANCE, COURSE OF DEALING OR TRADE USAGE.

This Warranty is exclusive and limited to repair or, at the discretion of Banner Engineering Corp., replacement. **IN NO EVENT SHALL BANNER ENGINEERING CORP. BE LIABLE TO BUYER OR ANY OTHER PERSON OR ENTITY FOR ANY EXTRA COSTS, EXPENSES, LOSSES, LOSS OF PROFITS, OR ANY INCIDENTAL, CONSEQUENTIAL OR SPECIAL DAMAGES RESULTING FROM ANY PRODUCT DEFECT OR FROM THE USE OR INABILITY TO USE THE PRODUCT, WHETHER ARISING IN CONTRACT OR WARRANTY, STATUTE, TORT, STRICT LIABILITY, NEGLIGENCE, OR OTHERWISE.**

Banner Engineering Corp. reserves the right to change, modify or improve the design of the product without assuming any obligations or liabilities relating to any product previously manufactured by Banner Engineering Corp. Any misuse, abuse, or improper application or installation of this product or use of the product for personal protection applications when the product is identified as not intended for such purposes will void the product warranty. Any modifications to this product without prior express approval by Banner Engineering Corp will void the product warranties. All specifications published in this document are subject to change; Banner reserves the right to modify product specifications or update documentation at any time. Specifications and product information in English supersede that which is provided in any other language. For the most recent version of any documentation, refer to: www.bannerengineering.com.

For patent information, see www.bannerengineering.com/patents.

Notas Adicionales

Información México: La operación de este equipo está sujeta a las siguientes dos condiciones: 1) es posible que este equipo o dispositivo no cause interferencia perjudicial y 2) este equipo debe aceptar cualquier interferencia, incluyendo la que pueda causar su operación no deseada.

Banner es una marca registrada de Banner Engineering Corp. y podrán ser utilizadas de manera indistinta para referirse al fabricante. "Este equipo ha sido diseñado para operar con las antenas tipo Omnidireccional para una ganancia máxima de antena de 6 dBd y Yagi para una ganancia máxima de antena 10 dBd que en seguida se enlistan. También se incluyen aquellas con aprobación ATEX tipo Omnidireccional siempre que no excedan una ganancia máxima de antena de 6dBd. El uso con este equipo de antenas no incluidas en esta lista o que tengan una ganancia mayor que 6 dBd en tipo omnidireccional y 10 dBd en tipo Yagi, quedan prohibidas. La impedancia requerida de la antena es de 50 ohms."

Approved antennas

Antenas SMA	Modelo	Antenas Tipo-N	Modelo
Antena, Omni 902-928 MHz, 2 dBd, junta de caucho, RP-SMA Macho	BWA-9O2-C	Antena, Omni 902-928 MHz, 6 dBd, fibra de vidrio, 1800mm, N Hembra	BWA-9O6-A
Antena, Omni 902-928 MHz, 5 dBd, junta de caucho, RP-SMA Macho	BWA-9O5-C	Antena, Yagi, 900 MHz, 10 dBd, N Hembra	BWA-9Y10-A

Mexican Importer

Banner Engineering de México, S. de R.L. de C.V.
 David Alfaro Siqueiros 103 Piso 2 Valle oriente
 San Pedro Garza Garcia Nuevo León, C. P. 66269

81 8363.2714

Document title: Sure Cross® Wireless Q45DD and Q45LPD All-in-One D-Cell Photoelectric Sensor Node

Part number: 223998

Revision: C

© Banner Engineering Corp. All rights reserved.