



U.S. & For. Pat. Issued & Pend.

PCB MOUNT FOR BI/TRI-LEAD LEDs

FEATURES

- Right angle PCB mount for bi and tri-lead LEDs for use as logic and diagnostic indicators
- Accommodates round and rectangular shapes of LEDs with or without flanges
- Dove-tail interlock feature allows mounting of both mono and multi-colored LEDs
- Mount forms LED leads which are locked into position by retaining tabs
- Formed LED leads are staggered in their length permitting easier PCB insertion
- Molded standoffs permit the easy cleaning of PCB after wave soldering operation

PCB MOUNTING OF BI & TRI-LEAD LEDs

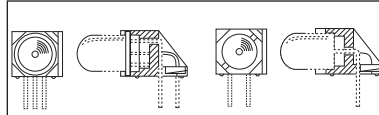

Form leads with the mount, snap leads into retaining tabs.

PCB MOUNTING OF LEDs IN ARRAYS

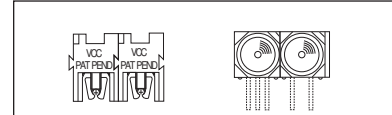

Bi-lead and tri-lead LEDs can be combined with dove-tail interlocking feature.

OUTLINE DRAWINGS

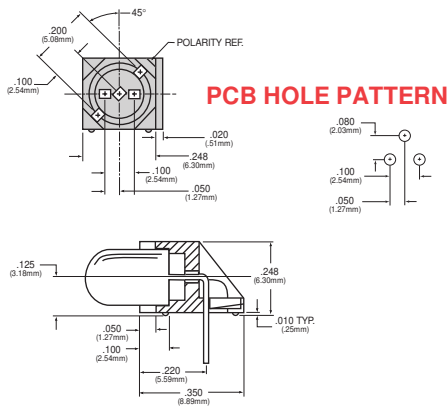

SPECIFICATIONS

MATERIALS: Housing – Thermoplastic (black) U.L. 94 V0.

MOUNTING: PCH 175 – Right angle Thru-The-Hole mount for LEDs. Can be used as a single LED mount or banded together in an array with its dove-tail interlocking feature.

When banded together with the PCH 175 the LEDs are on .250" centers.

LED: 5mm size - round or rectangular shape with or without flange. Bi-lead, standard .100" lead spacing. Tri-lead, either .050" or .100" lead spacing. Both the bi-lead and tri-lead LEDs can also be combined in arrays with one another.

ORDERING CODES

MODEL _____ **PCH 175**

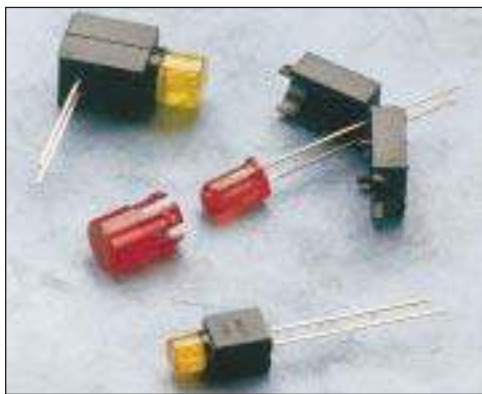

U.S. & For. Pat. Issued & Pend.

PCB MOUNTS FOR 3mm & 5mm LEDs

FEATURES

- Wave solders horizontally or vertically without special jigs or fixtures
- Stabilizes LED during packaging and physically protects after assembly
- Mounts flush, recessed or fully extended thru display panel without attachments
- Height compatible with switches and other circuit board mounted components
- Increases LED apparent brightness and viewing angle up to 180 degrees
- Guards against IC damage by electrostatic discharge transmitted thru exposed LED

HORIZONTAL MOUNT

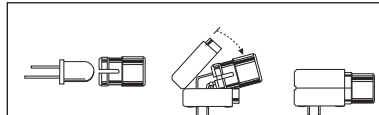

Snap LED into lense – insert LED leads through holes in mount base – close mount, bending leads into position.

VERTICAL MOUNT

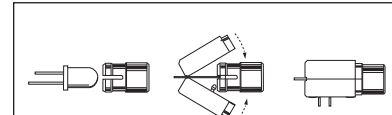

Snap LED into lense – insert LED leads through holes in mount base – close mount.

OUTLINE DRAWINGS

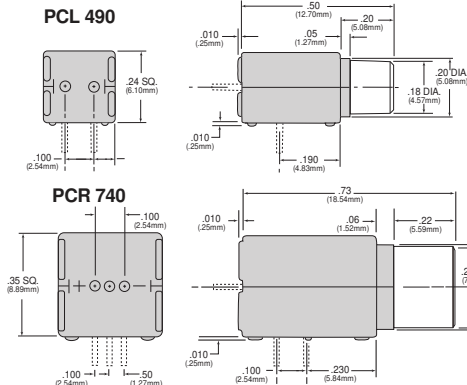

RECOMMENDED LEDs See Cliplite Lens Data Page.

SPECIFICATIONS

MATERIAL Body – General Purpose Nylon (U.L. Listed Materials).

Lens – Polycarbonate (U.L. Listed).

MOUNTING P C board, horizontally or vertically on .100 inch hole centers.

3mm (PCL 490 with SML 190) panel thickness from 1/64" to 3/16" thru a 7/32" clearance hole.

5mm (PCR 740 with CLF 280) panel thickness from 1/32" to 9/32" thru a 5/16" clearance hole. CLP series of the CLIPLITE clipmounts may also be used.

Permits flush mounting to full projection of the lens portion thru the panel.

LEDs Standard LEDs, diffused or nondiffused. See drawings. No attempt should be made to bend a lead with a stepped thickness.

ORDERING CODES

MODEL (BODY) _____ **PCL 490**

PCL 490 (3mm)
 PCR 740 (5mm)

MODEL (LENS) _____ **SML 190 RTP**

SML 190 (3mm)
 CLF 280 (5mm)

COLOR

RTP Red Transparent
 GTP Green Transparent
 ATP Amber Transparent
 YTP Yellow Transparent
 CTP Clear Transparent
 BTP Blue Transparent