

6-PIN DIP OPTOCOUPLERS FOR POWER SUPPLY APPLICATIONS (NO BASE CONNECTION)

MOC8111

MOC8112

MOC8113

PACKAGE

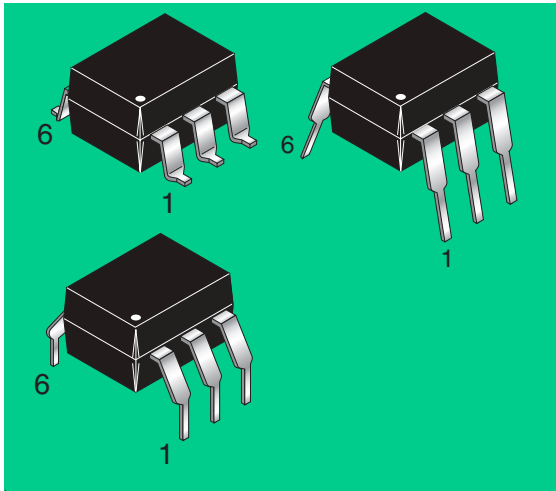

SCHEMATIC

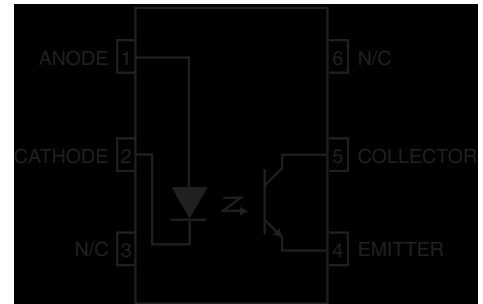

DESCRIPTION

The MOC811X series consists of a Gallium Arsenide IRED coupled with an NPN phototransistor. The base of the transistor is not bonded to an external pin for improved noise immunity.

FEATURES

- High isolation voltage
5300 VAC RMS—1 minute
- High BV_{CEO} minimum 70 Volts
- Current transfer ratio in selected groups:
MOC8111: 20% min.
MOC8112: 50% min.
MOC8113: 100% min.
- Maximum switching time in saturation specified
- Underwriters Laboratory (UL) recognized (File #E90700)
- VDE recognized (File #94766)

APPLICATIONS

- Power Supply Regulators
- Digital Logic Inputs
- Microprocessor Inputs
- Appliance Sensor Systems
- Industrial Controls

6-PIN DIP OPTOCOUPPLERS FOR POWER SUPPLY APPLICATIONS (NO BASE CONNECTION)

MOC8111

MOC8112

MOC8113

ABSOLUTE MAXIMUM RATINGS ($T_A = 25^\circ\text{C}$ Unless otherwise specified)

Parameter	Symbol	Value	Unit
INPUT LED			
Forward Current – Continuous	I_F	90	mA
Forward Current – Peak (PW = 1 μ s, 300pps)	$I_F(\text{pk})$	3	A
Reverse Voltage	V_R	6	Volts
LED Power Dissipation @ $T_A = 25^\circ\text{C}$	P_D	135	mW
Derate above 25 $^\circ\text{C}$		1.8	mW/ $^\circ\text{C}$
OUTPUT TRANSISTOR			
Detector Power Dissipation @ $T_A = 25^\circ\text{C}$	P_D	200	mW
Derate above 25 $^\circ\text{C}$		2.67	mW/ $^\circ\text{C}$
TOTAL DEVICE			
Total Device Power Dissipation @ $T_A = 25^\circ\text{C}$	P_D	260	mW
Derate above 25 $^\circ\text{C}$		3.5	mW/ $^\circ\text{C}$
Ambient Operating Temperature Range	T_{OPR}	-55 to +100	$^\circ\text{C}$
Storage Temperature Range	T_{STG}	-55 to +150	$^\circ\text{C}$
Lead Soldering Temperature (1/16" from case, 10 sec. duration)	T_{SOL}	260	$^\circ\text{C}$

6-PIN DIP OPTOCOUPPLERS FOR POWER SUPPLY APPLICATIONS (NO BASE CONNECTION)

MOC8111

MOC8112

MOC8113

ELECTRICAL CHARACTERISTICS ($T_A = 25^\circ\text{C}$ Unless otherwise specified)

INDIVIDUAL COMPONENT CHARACTERISTICS

Parameter	Test Conditions	Symbol	Device	Min	Typ	Max	Unit
EMITTER							
Input Forward Voltage	$I_F = 60 \text{ mA}$	V_F	All		1.35	1.65	V
	$I_F = 10 \text{ mA}$				1.15	1.50	
Reverse Voltage	$I_R = 10 \text{ }\mu\text{A}$	V_R	All	6.0	15		V
Capacitance	$V_F = 0 \text{ V}, f = 1.0 \text{ MHz}$	C_J	All		50		pF
	$V_F = 1 \text{ V}, f = 1.0 \text{ MHz}$				65		
Reverse Leakage Current	$V_R = 3.0 \text{ V}$	I_R	All		.35	10	μA
DETECTOR							
Breakdown Voltage Collector to Emitter	$I_C = 1.0 \text{ mA}, I_F = 0$	BV_{CEO}	All	70			V
Breakdown Voltage Emitter to Collector	$I_E = 100 \text{ }\mu\text{A}, I_F = 0$	BV_{ECO}	All	7			V
Leakage Current Collector to Emitter	$V_{CE} = 10 \text{ V}, I_F = 0$	I_{CEO}	All		5	50	V
Capacitance Collector to Emitter	$V_{CE} = 0 \text{ V}, f = 1 \text{ MHz}$	C_{CE}	All		8		pF

ISOLATION CHARACTERISTICS

Characteristic	Test Conditions	Symbol	Min	Typ	Max	Units
Input-Output Isolation Voltage	$f = 60 \text{ Hz}, t = 1 \text{ min.}$	V_{ISO}	5300			V_{RMS}
Isolation Resistance	$V_{I-O} = 500 \text{ VDC}$	R_{ISO}	10^{11}			Ω
Isolation Capacitance	$V_{I-O} = 0, f = 1 \text{ MHz}$	C_{ISO}		0.5		pF

6-PIN DIP OPTOCOUPLEDERS FOR POWER SUPPLY APPLICATIONS (NO BASE CONNECTION)

MOC8111

MOC8112

MOC8113

TRANSFER CHARACTERISTICS ($T_A = 25^\circ\text{C}$ Unless otherwise specified)

DC CHARACTERISTICS	Test Conditions	Symbol	Device	Min	Typ	Max	Units
Output/Input Current Transfer Ratio	$I_F = 10\text{ mA}, V_{CE} = 5\text{ V}$	CTR	MOC8111	20			%
			MOC8112	50			
			MOC8113	100			
Collector-Emitter Saturation Voltage	$I_F = 10\text{ mA}, I_C = 2.5\text{ mA}$	$V_{CE(SAT)}$	All		0.27	0.4	V
AC CHARACTERISTICS \emptyset	Test Conditions	Symbol	Device	Min	Typ	Max	Units
Non-Saturated Switching Times							
Turn-On Time	$R_L = 100\ \Omega, I_C = 2\text{ mA}, V_{CC} = 10\text{ V}$ See Figure 7	t_{on}	All		6.0	10	μS
Turn-Off Time		t_{off}	All		5.5	10	μS
Saturated Switching Times							
Turn-On Time	$I_F = 20\text{ mA}, V_{CE} = 0.4\text{ V}$	t_{on}	MOC8111		3.0	5.5	μS
	$I_F = 10\text{ mA}, V_{CE} = 0.4\text{ V}$		MOC812, MOC8113		4.2	8.0	
Rise-Time	$I_F = 20\text{ mA}, V_{CE} = 0.4\text{ V}$	t_r	MOC8111		2.0	4.0	μS
	$I_F = 10\text{ mA}, V_{CE} = 0.4\text{ V}$		MOC812, MOC8113		3.0	6.0	
Turn-Off Time	$I_F = 20\text{ mA}, V_{CE} = 0.4\text{ V}$	t_{off}	MOC8111		18	34	μS
	$I_F = 10\text{ mA}, V_{CE} = 0.4\text{ V}$		MOC812, MOC8113		23	39	
Fall-Time	$I_F = 20\text{ mA}, V_{CE} = 0.4\text{ V}$	t_f	MOC8111		11	20	μS
	$I_F = 10\text{ mA}, V_{CE} = 0.4\text{ V}$		MOC812, MOC8113		14	24	

6-PIN DIP OPTOCOUPPLERS FOR POWER SUPPLY APPLICATIONS (NO BASE CONNECTION)

MOC8111

MOC8112

MOC8113

TYPICAL PERFORMANCE CURVES

Fig. 1 LED Forward Voltage vs. Forward Current

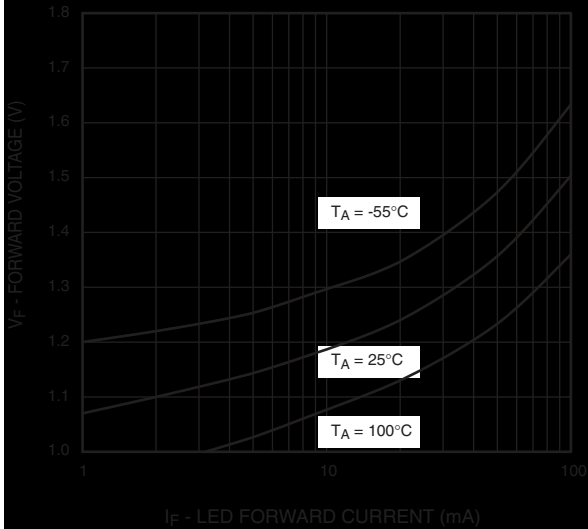

Fig. 2 Normalized CTR vs. Forward Current

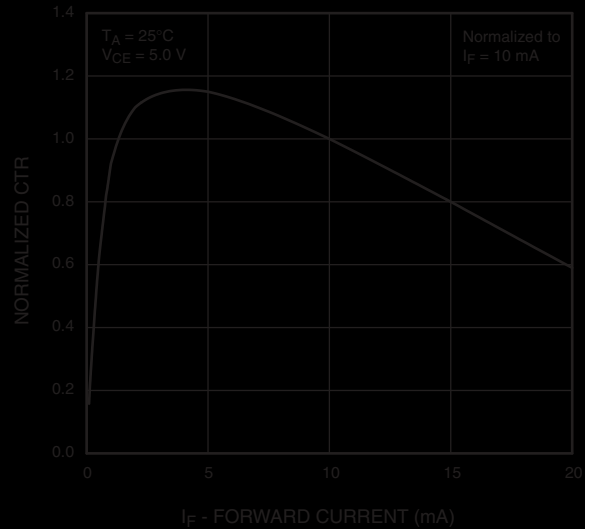

Fig. 3 Normalized CTR vs. Ambient Temperature

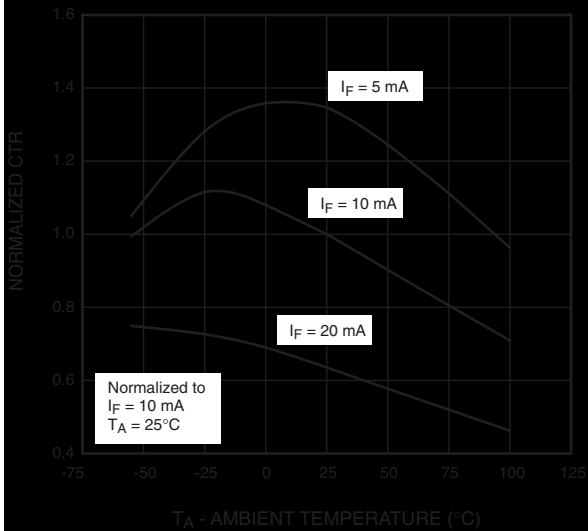
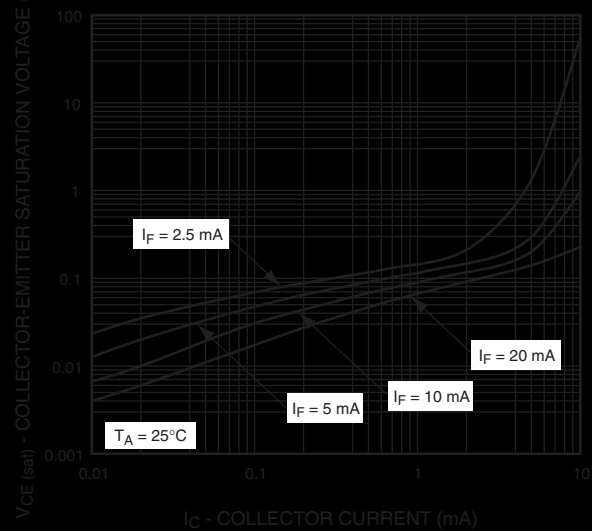

Fig. 4 Collector Emitter Saturation Voltage vs. Collector Current



6-PIN DIP OPTOCOUPPLERS FOR POWER SUPPLY APPLICATIONS (NO BASE CONNECTION)

MOC8111

MOC8112

MOC8113

TYPICAL PERFORMANCE CURVES (continued)

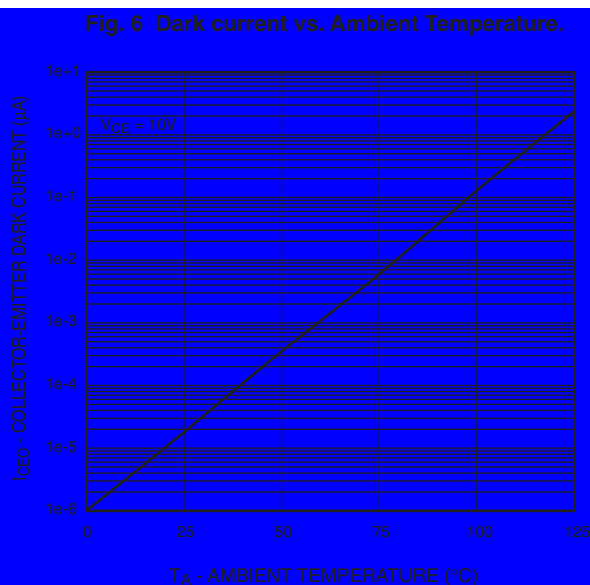
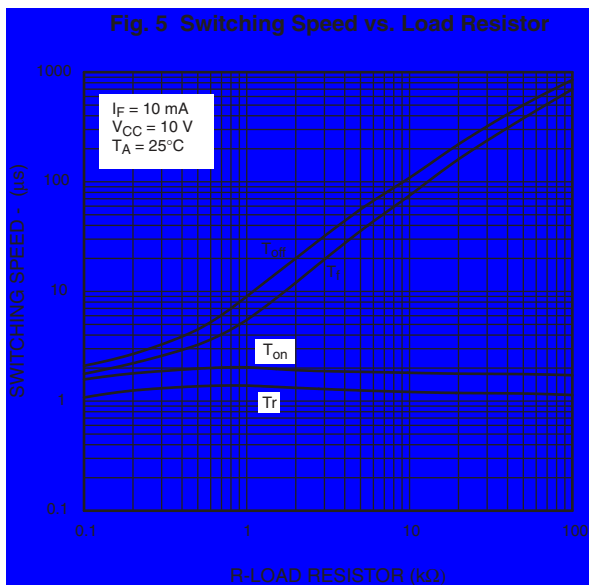
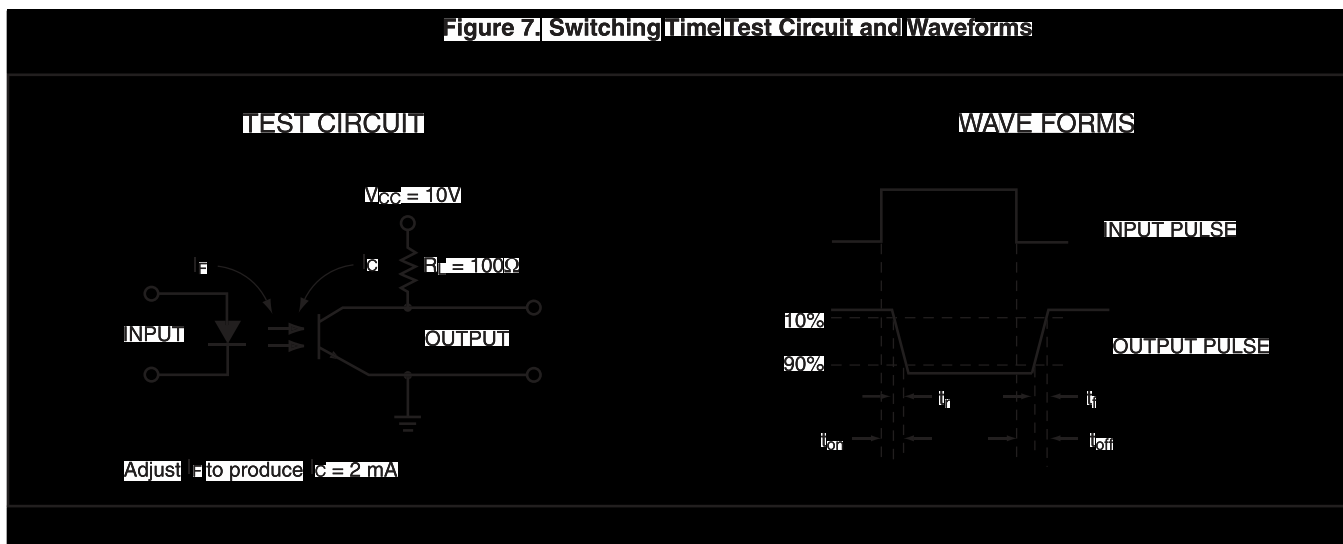

Figure 7. Switching Time Test Circuit and Waveforms



6-PIN DIP OPTOCOUPPLERS FOR POWER SUPPLY APPLICATIONS (NO BASE CONNECTION)

MOC8111

MOC8112

MOC8113

Package Dimensions (Through Hole)

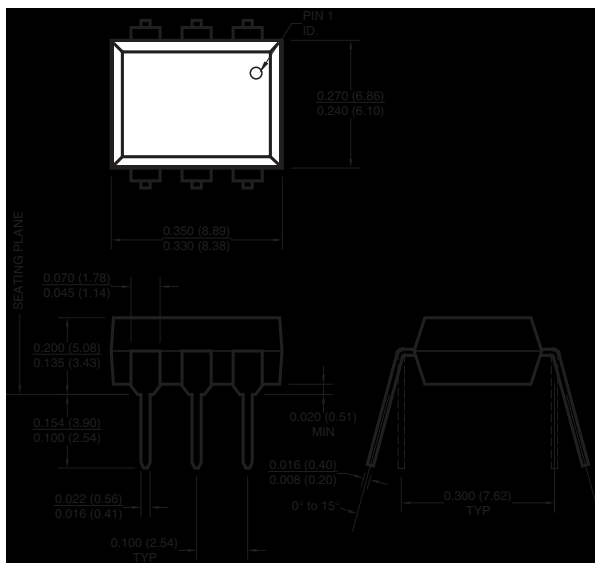

Package Dimensions (Surface Mount)

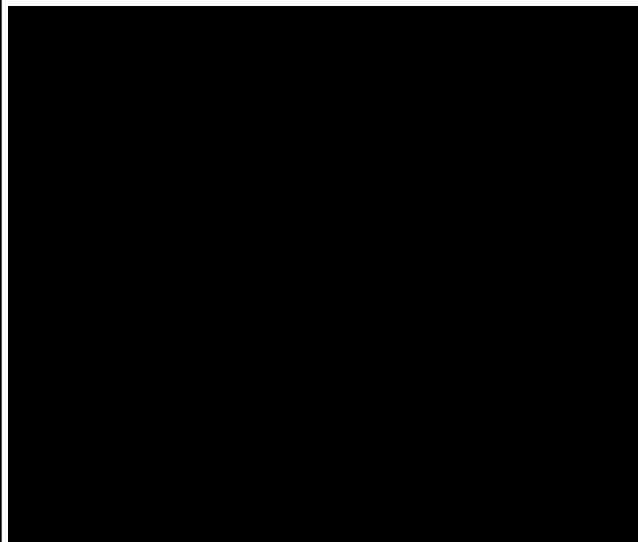

Package Dimensions (0.4" Lead Spacing)



Recommended Pad Layout for Surface Mount Leadform

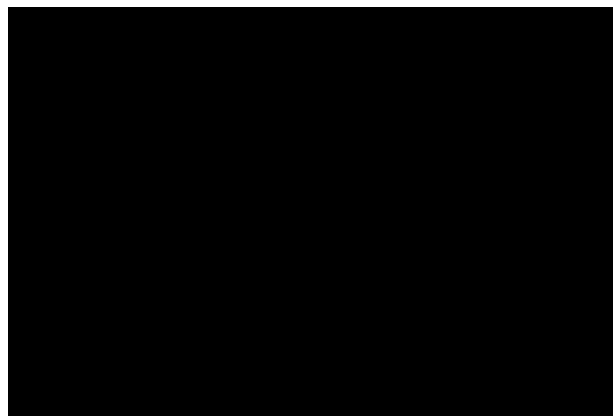

NOTE

All dimensions are in inches (millimeters)

6-PIN DIP OPTOCOUPPLERS FOR POWER SUPPLY APPLICATIONS (NO BASE CONNECTION)

MOC8111

MOC8112

MOC8113

ORDERING INFORMATION

Option	Example Part Number	Description
No Suffix	MOC8111	Through Hole
S	MOC8111S	Surface Mount Lead Bend
SD	MOC8111SD	Surface Mount; Tape and Reel
W	MOC8111W	0.4" Lead Spacing
300	MOC8111300	VDE 0884
300W	MOC8111300W	VDE 0884, 0.4" Lead Spacing
3S	MOC81113S	VDE 0884, Surface Mount
3SD	MOC81113SD	VDE 0884, Surface Mount, Tape and Reel

MARKING INFORMATION

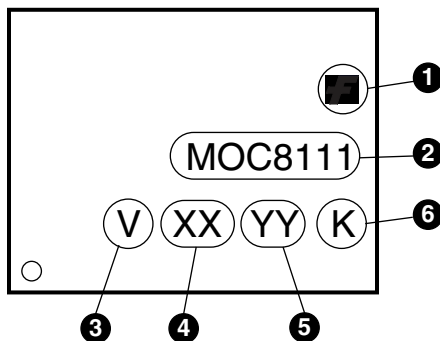

Definitions	
1	Fairchild logo
2	Device number
3	VDE mark (Note: Only appears on parts ordered with VDE option – See order entry table)
4	Two digit year code, e.g., '03'
5	Two digit work week ranging from '01' to '53'
6	Assembly package code

6-PIN DIP OPTOCOUPPLERS FOR POWER SUPPLY APPLICATIONS (NO BASE CONNECTION)

MOC8111

MOC8112

MOC8113

Carrier Tape Specifications

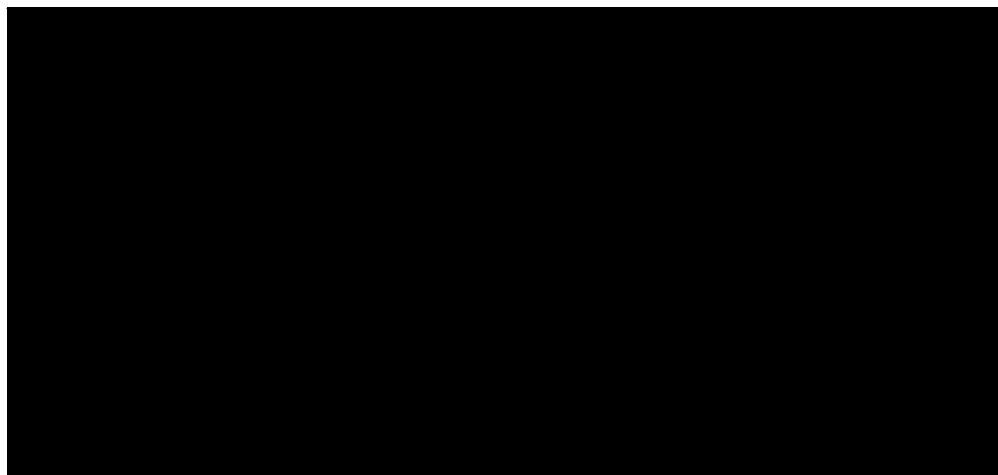

NOTE

All dimensions are in inches (millimeters)

Reflow Profile (Black Package, No Suffix)

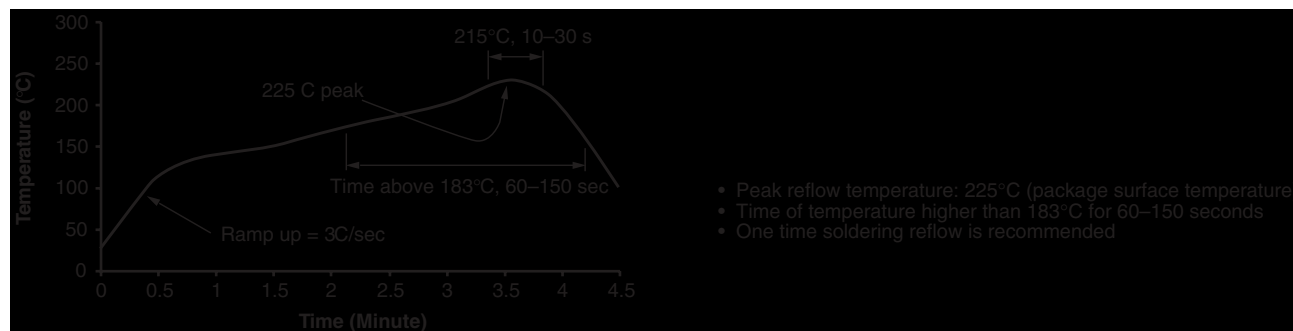



6-PIN DIP OPTOCOUPPLERS FOR POWER SUPPLY APPLICATIONS (NO BASE CONNECTION)

MOC8111**MOC8112****MOC8113**

DISCLAIMER

FAIRCHILD SEMICONDUCTOR RESERVES THE RIGHT TO MAKE CHANGES WITHOUT FURTHER NOTICE TO ANY PRODUCTS HEREIN TO IMPROVE RELIABILITY, FUNCTION OR DESIGN. FAIRCHILD DOES NOT ASSUME ANY LIABILITY ARISING OUT OF THE APPLICATION OR USE OF ANY PRODUCT OR CIRCUIT DESCRIBED HEREIN; NEITHER DOES IT CONVEY ANY LICENSE UNDER ITS PATENT RIGHTS, NOR THE RIGHTS OF OTHERS.

LIFE SUPPORT POLICY

FAIRCHILD'S PRODUCTS ARE NOT AUTHORIZED FOR USE AS CRITICAL COMPONENTS IN LIFE SUPPORT DEVICES OR SYSTEMS WITHOUT THE EXPRESS WRITTEN APPROVAL OF THE PRESIDENT OF FAIRCHILD SEMICONDUCTOR CORPORATION. As used herein:

1. Life support devices or systems are devices or systems which, (a) are intended for surgical implant into the body, or (b) support or sustain life, and (c) whose failure to perform when properly used in accordance with instructions for use provided in the labeling, can be reasonably expected to result in a significant injury of the user.
2. A critical component in any component of a life support device or system whose failure to perform can be reasonably expected to cause the failure of the life support device or system, or to affect its safety or effectiveness.