

### General information

Part number	S22LOC-P02MTQ0-420S
Termination	solder
Size	2
Locking principle	push
Coding	0_key
Cable Diameter	cable_mini_42
Cable outlet	bend_relief

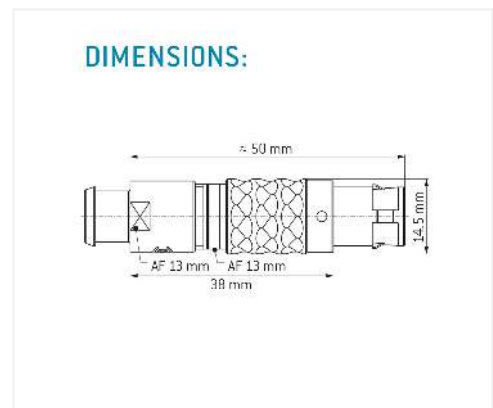

### Contact insert description

Number of contacts	2
Contact type	pins
Contact diameter	20mm
Insulator material	peek
Wire cross section	14_awg
Termination	solder
Termination diameter	185mm

reverse\_gender\_on\_request

### Technical information

Max. creepage and air clearance distance	16_mm	12_mm
Nominal current single contact	24_a	iec_60512_5_2
Nominal current insert	24 A	vde_0298_4
Test voltage	21_kv_ac	sae_13441

safety\_text

## Mechanical and environmental data

Degree of protection*	ip50
-----------------------	------

Operating temperature	40_120_c
-----------------------	----------

Mating cycles	5000
---------------	------

mated\_unmated

## Material and surface treatments

Housing	m_chrome
---------	----------

Contact	cu_alloy_gold
---------	---------------

safety\_text\_2

ul\_text

illustrative\_text