

Line Regulator Controller

Features

- Low Dropout Voltage: 100mV @ 650mA with FZT749 PNP Transistor
- 2.7V to 8V Supply Range
- Low Operating Current: 50µA Operating, 0.2µA Shutdown
- Low True Chip Enable
- Output Accuracy <math>< \pm 2\%</math>
- Small Package: 5-Pin SOT-23A

Applications

- Battery Operated Systems
- Portable Instruments
- High-Efficiency Linear Regulator
- Post-Regulator for SMPS
- Power Supply or Battery Back-Up Supply for Memory

Device Selection Table

Part Number	Output Voltage	Package	Temperature Range
TC572502ECT	2.5V	5-Pin SOT-23A	-40°C to +85°C
TC573002ECT	3.0V	5-Pin SOT-23A	-40°C to +85°C
TC573302ECT	3.3V	5-Pin SOT-23A	-40°C to +85°C

Other output voltages and package options are available. Please contact Microchip Technology Inc. for details.

Package Type

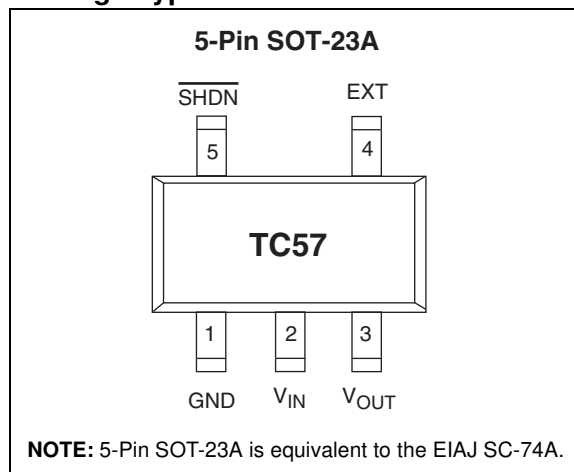

General Description

The TC57 is a low dropout regulator controller that operates with an external PNP pass transistor, allowing the user to tailor the LDO characteristics to suit the application at hand. This results in lower dropout operation (and often lower cost) compared with traditional linear regulators with on-board pass transistors. The maximum output current of a TC57-based regulator circuit is limited only by the characteristics of the external pass transistor. For example, a maximum output current of 650mA (with a dropout voltage of 100mV) results when an FZT749 pass transistor is used, while a Darlington configuration can deliver up to 4A.

Flexibility, and superior performance make this family of regulator controllers the ideal choice in applications where low dropout voltage and low installed cost are key.

Functional Block Diagram

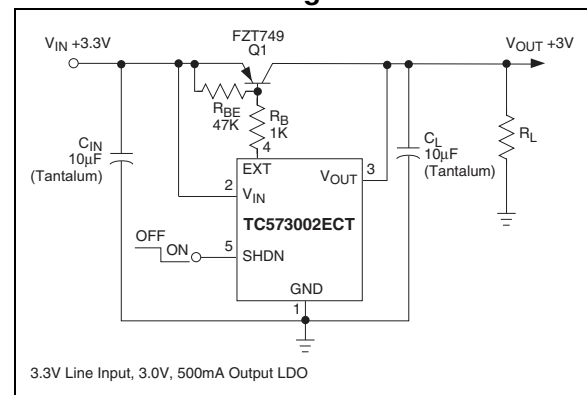

TC57

1.0 ELECTRICAL CHARACTERISTICS

Absolute Maximum Ratings*

Input Voltage	+12V
Output Current	50mA
Output Voltage.....	-0.3V to (V _{IN} + 0.3V)
Power Dissipation.....	150mW
Operating Temperature Range.....	-40°C to +85°C
Storage Temperature Range	-40°C to +150°C

*Stresses above those listed under "Absolute Maximum Ratings" may cause permanent damage to the device. These are stress ratings only and functional operation of the device at these or any other conditions above those indicated in the operation sections of the specifications is not implied. Exposure to Absolute Maximum Rating conditions for extended periods may affect device reliability.

TC55 ELECTRICAL SPECIFICATIONS

TC57EP3002 Electrical Characteristics: $\overline{\text{SHDN}} = \text{GND}$, $V_{\text{IN}} = V_{\text{OUT}} + 1\text{V}$, $V_{\text{OUT}} = 3\text{V to } 5\text{V}$, $I_{\text{OUT}} = 0$, $T_{\text{A}} = 25^{\circ}\text{C}$, Test Circuit of Figure 3-1, unless otherwise noted. (Note 2)						
Symbol	Parameter	Min	Typ	Max	Units	Test Conditions
V _{IN}	Input Voltage	—	—	8	V	
V _{EXT}	Voltage on EXT Output	—	—	8	V	
V _{OUT}	Output Voltage	0.98 × V _R	V _R ±0.5%	1.02 × V _R	V	I _{OUT} = 50mA (Note 1)
ΔV _{OUT}	Load Regulation	-60	—	60	mV	1mA ≤ I _{OUT} ≤ 100mA (Note 3)
V _{IN} - V _{OUT}	Dropout Voltage	—	100	—	mV	I _{OUT} = 100mA (Note 2)
I _{DD}	Supply Current	—	50	80	μA	$\overline{\text{VSHDN}} = V_{\text{IN}} = 5\text{V}$
I _{SHDN}	Shutdown Supply Current	—	—	0.6	μA	$\overline{\text{VSHDN}} = \text{GND}$
ΔV _{OUT} /ΔV _{IN}	Line Regulation	—	0.1	0.3	%/V	I _{OUT} = 50mA, 4V ≤ V _{IN} ≤ 8V (Note 3)
ΔV _{OUT} /ΔT	V _{OUT} Temperature Coefficient	—	±100	—	ppm/°C	I _{OUT} = 10mA, -40°C < T _J < +85°C (Note 3)
I _{LEXT}	EXT Pin Leakage Current	—	—	0.5	μA	
I _{EXT}	EXT Sink Current	—	—	25	mA	Note 4
V _{IH}	SHDN Input High Logic Threshold	1.5	—	—	V	
V _{IL}	SHDN Input Low Logic Threshold	—	—	0.25	V	
I _{IH}	SHDN Input Current @ V _{IH}	—	—	0.1	μA	$\overline{\text{VSHDN}} = V_{\text{IN}} = 5\text{V}$
I _{IL}	SHDN Input Current @ V _{IL}	-0.2	-0.05	0	μA	$\overline{\text{VSHDN}} = \text{GND}$

- Note**
- 1: V_R is the regulator output voltage setting.
 - 2: Dropout voltage is defined as the input to output differential at which the output voltage drops 2% below its nominal value measured at a 1V differential.
 - 3: Varies with type of pass transistor used. Numbers shown are for the test circuit of Figure 3-1.
 - 4: The product of I_{EXT} × V_{EXT} must be less than the maximum allowable power dissipation.

2.0 PIN DESCRIPTIONS

The descriptions of the pins are listed in Table 2-1.

TABLE 2-1: PIN FUNCTION TABLE

Pin No. (5-Pin SOT-23A)	Symbol	Description
1	GND	Ground terminal.
2	V_{IN}	Supply voltage input. Positive input voltage of 2.7V to 8.0V.
3	V_{OUT}	Regulator voltage sense input. Connects to the collector of the external PNP pass transistor.
4	EXT	Base Drive for the external PNP pass transistor.
5	SHDN	Shutdown Input. The device is enabled when $SHDN \leq V_{IL}$. The device enters a low power shutdown state when $SHDN \geq V_{IH}$. During shutdown, the output is disabled, and supply current falls to less than 1 μ A.

3.0 DETAILED DESCRIPTION

The TC57 series of precision low dropout regulator controllers use an external PNP transistor to accommodate a wide range of output currents. A series resistor (R_B) limits the maximum base current drawn from the PNP transistor. Limiting the base drive both determines the regulator's output current capability, as well as limits ground current when the device is operated in dropout. The PNP transistor's $V_{CE(SAT)}$ is the only factor limiting dropout voltage.

FIGURE 3-1: TEST CIRCUIT

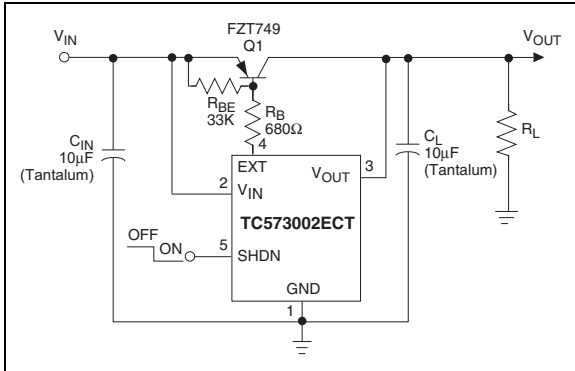

3.1 Transistor Selection

The PNP pass transistor must have satisfactory power dissipation, current gain, and collector current specifications to suit the application at hand. The maximum output current the regulator can deliver is influenced by h_{FE} . The highest guaranteed output current is given by:

EQUATION 3-1:

$$I_{LOAD(MAX)} = 25 \text{ mA} \times h_{FE(MIN)}$$

The transistor's actual power dissipation (PD) is equal to the maximum load current times the maximum input/output voltage differential, or:

EQUATION 3-2:

$$P_D \approx I_{LOAD(MAX)} \times (V_{IN(MAX)} - V_{OUT(MIN)})$$

The ideal transistor has a minimum h_{FE} of 100, and a $V_{CE(SAT)}$ of less than 0.6V at full output current. For example, the Zetex FZT749 has an h_{FE} of 170 at a collector current of 1A, and a guaranteed $V_{CE(SAT)}$ of 0.3V at a base current of 100mA. It is packaged in a SOT-223 and is recommended for use with the TC57. Other transistors are also suitable, depending on the required input and output voltages and output current (Table 3-1).

3.2 Base-Current Limiting Resistor

Base current limiting resistor R_B can be estimated using:

EQUATION 3-3:

$$R_B = \frac{h_{FE} (V_{IN} - V_{BE})}{I_{OUT}}$$

Where:

h_{FE} is the current gain of the pass transistor

V_{IN} is the input voltage (in volts)

V_{BE} is the base-emitter voltage at the desired output current (in volts)

I_{OUT} is the output current (in Amps)

For example, assume a desired continuous output current of 1.0A, an input voltage of 5V, and an FZT749 pass transistor. The FZT749 has a typical h_{FE} of 170, and a V_{BE} of 0.8V; both specified at a collector current of 1.0A. Substituting these values into the equation above results in an R_B value of 704Ω (closest standard value = 680Ω).

3.3 Pull-Up Resistor and Output Capacitor

A pull-up resistor (R_{BE} , installed between the base and emitter of the pass transistor) facilitates rapid turn-off of the pass transistor in the event of a sudden decrease in load (Figure 3-2). Recommended values for this resistor are between 20KΩ and 47KΩ. A Tantalum output capacitor of at least 10μF must be used to guarantee stability. Higher values decrease output noise and eliminate power-on overshoot, but extend power-up times. Table 3-1 lists several capacitor choices.

FIGURE 3-2: 3.3V, 1A REGULATOR USING 5V SUPPLY INPUT

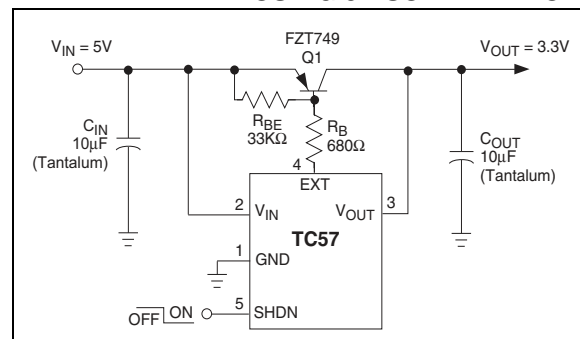

3.4 Input Capacitor

The addition of an input capacitor further reduces output noise, and negates the effects of power supply input impedance. A 10 μ F (min) Tantalum capacitor is recommended.

3.5 Shutdown Mode

The TC57 enters a low power shutdown mode when the shutdown input (SHDN) is high. During shutdown, the regulator is disabled, the output capacitor is discharged through the load, and supply current to the TC57 decreases to less than 1 μ A. Normal operation resumes when SHDN is brought low. If the shutdown mode is not used, SHDN should be tied to V_{IN} .

TABLE 3-1: COMPONENT SUPPLIERS

Device	Mounting Method	Manufacturer	Website
CAPACITORS			
267 Series	Surface Mount	Matsuo	http://www.matsuoelectronics.com
F95 Tantalum Series	Surface Mount	Nichicon	http://www.nichicon-us.com
595 Tantalum Series	Surface Mount	Sprague	http://www.vishay.com/brands/sprague
OS-CON Series	Through-Hole	Sanyo	http://www.sanyovideo.com
LXF Series	Through-Hole	United Chemi-Con	http://chemi-con.com
TRANSISTORS			
ZTX749	Through-Hole	Zetex	http://www.zetex.com
2N4403	Through-Hole	ON SEMI	http://www.onsemi.com/home
2N2907A	Through-Hole	ON SEMI	http://www.onsemi.com/home
FZT749	Surface Mount	Zetex	http://www.zetex.com

4.0 TYPICAL CHARACTERISTICS

Note: The graphs and tables provided following this note are a statistical summary based on a limited number of samples and are provided for informational purposes only. The performance characteristics listed herein are not tested or guaranteed. In some graphs or tables, the data presented may be outside the specified operating range (e.g., outside specified power supply range) and therefore outside the warranted range.

1. OUTPUT VOLTAGE vs. OUTPUT CURRENT

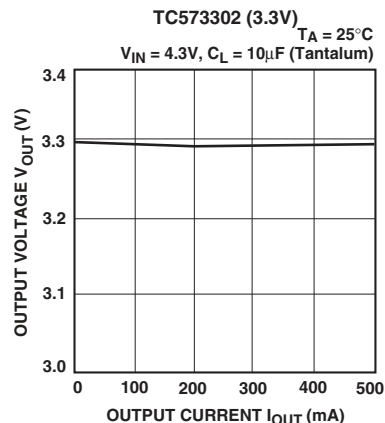
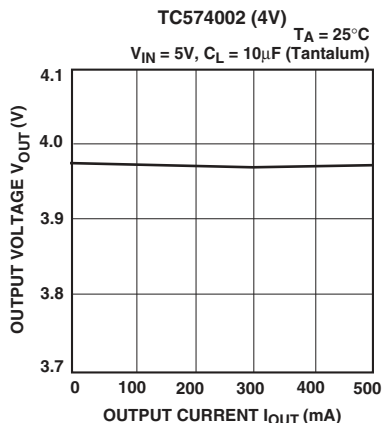
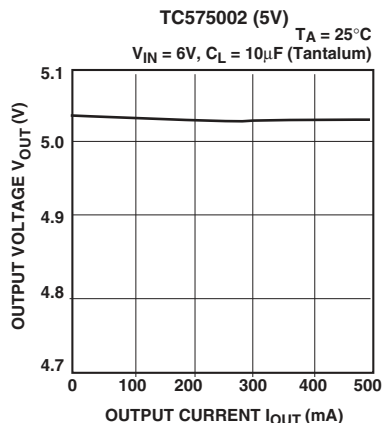

2. OUTPUT VOLTAGE vs. INPUT VOLTAGE

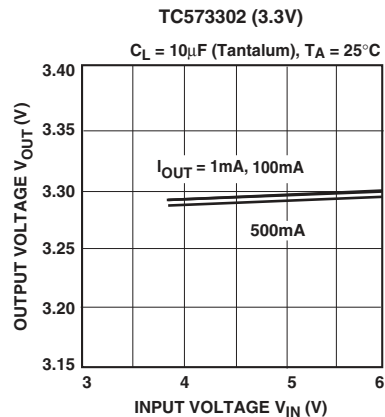
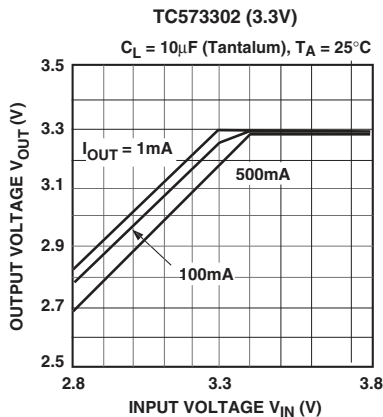
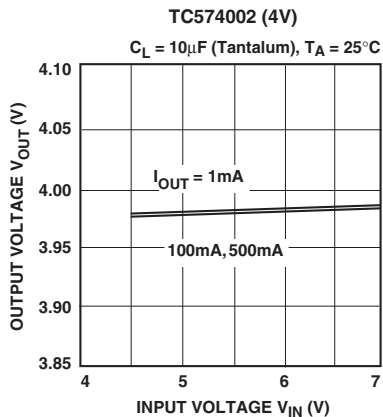
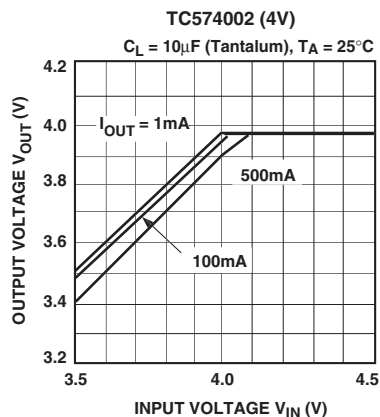
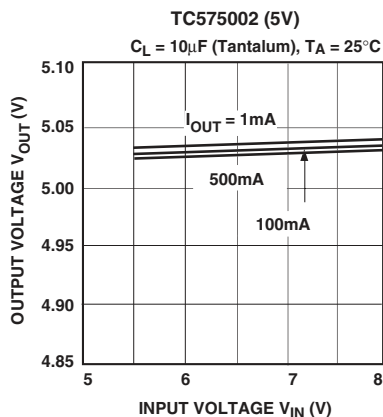
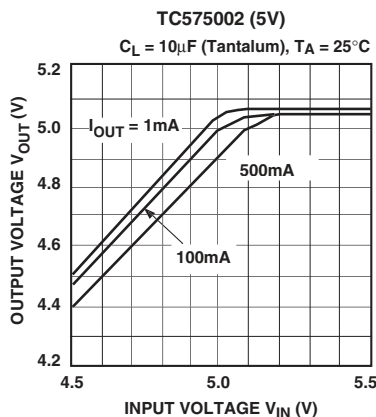

4.0 TYPICAL CHARACTERISTICS (CONTINUED)

3. DROPOUT VOLTAGE vs. OUTPUT CURRENT

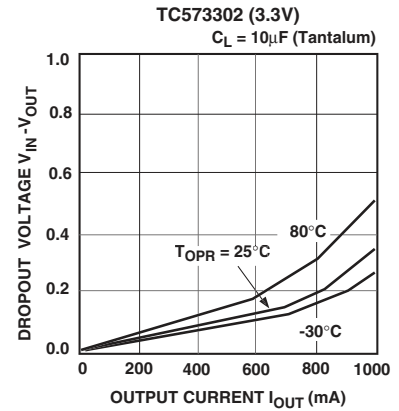
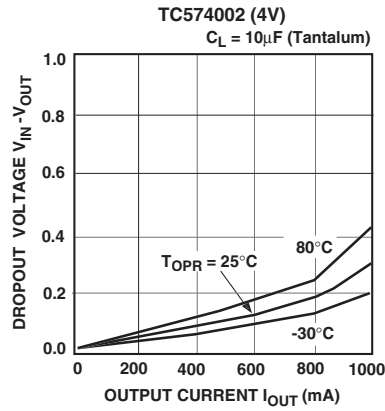
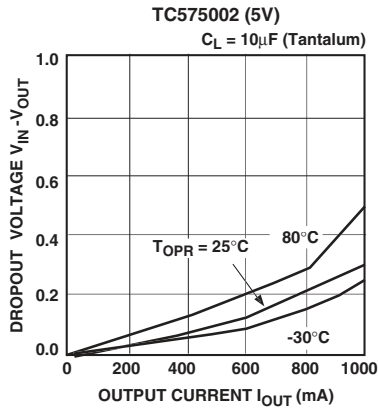

4. SUPPLY CURRENT vs. INPUT VOLTAGE

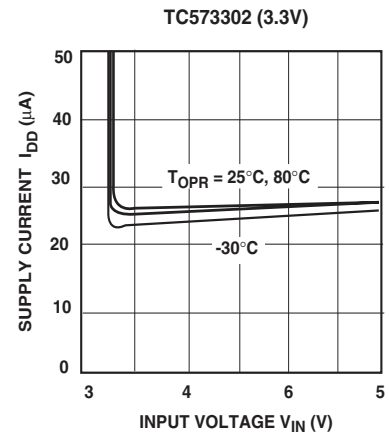
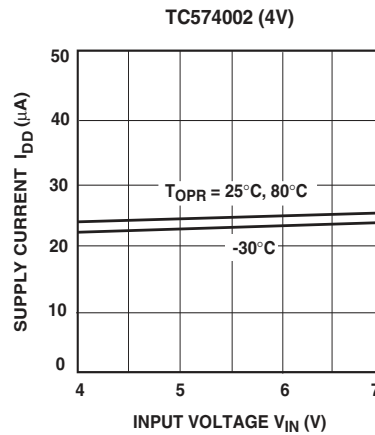
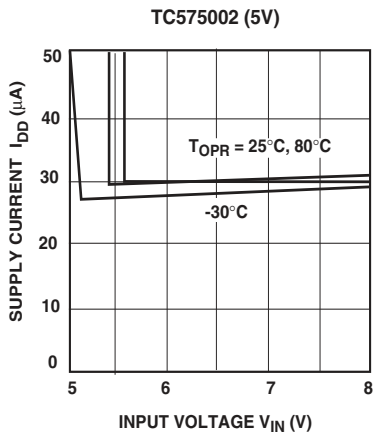

5. OUTPUT VOLTAGE vs. AMBIENT TEMPERATURE

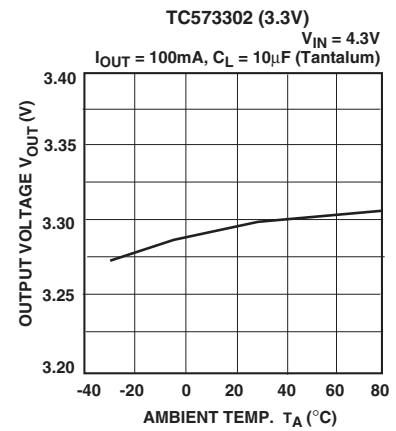
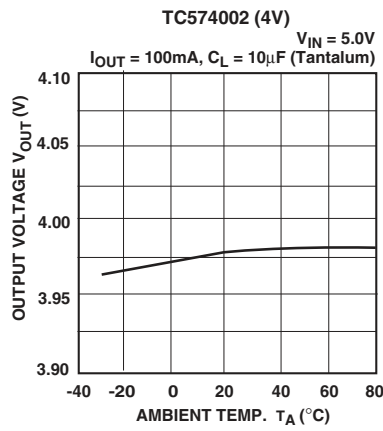
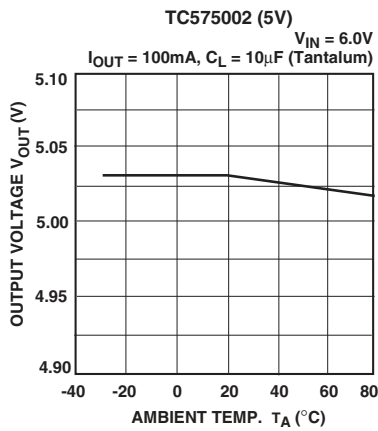

4.0 TYPICAL CHARACTERISTICS (CONTINUED)

6. SUPPLY CURRENT vs. AMBIENT TEMPERATURE

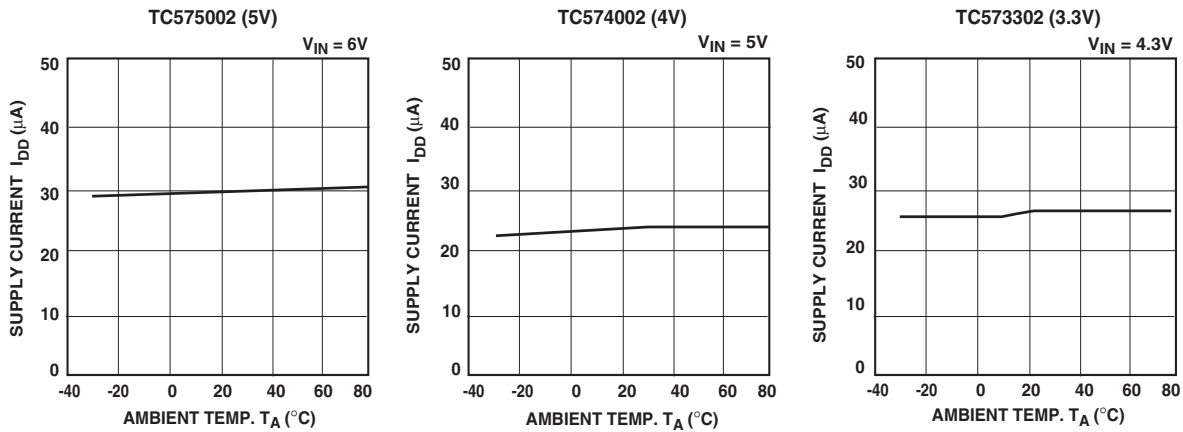

7. INPUT TRANSIENT RESPONSE

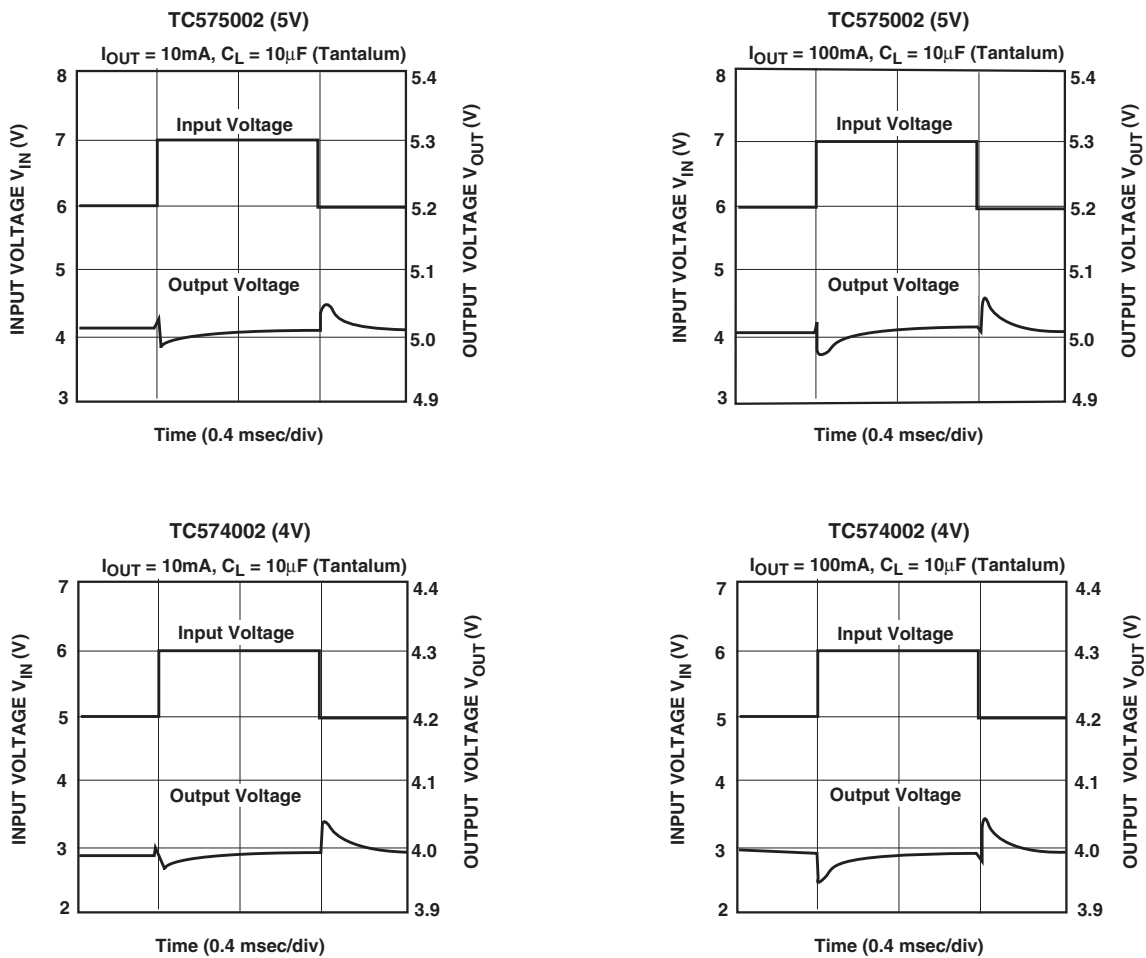

4.0 TYPICAL CHARACTERISTICS (CONTINUED)

7. INPUT TRANSIENT RESPONSE (CONT.)

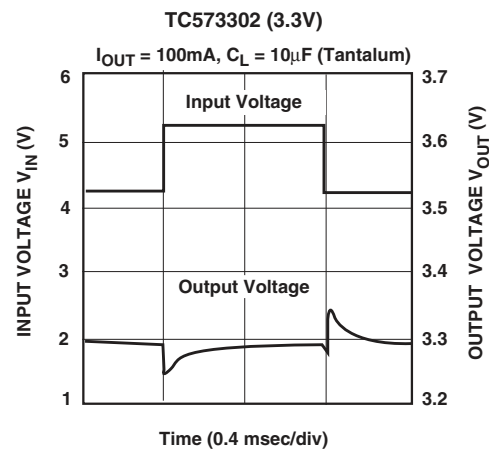
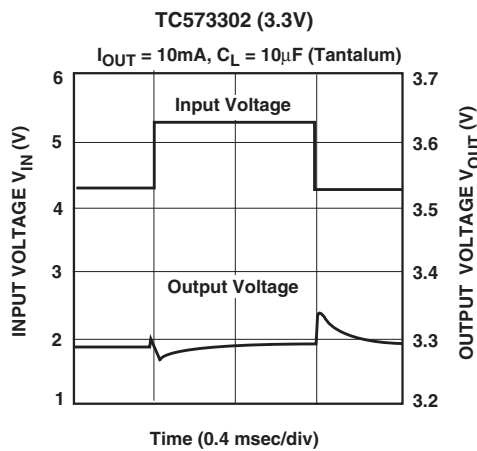

8. LOAD TRANSIENT RESPONSE

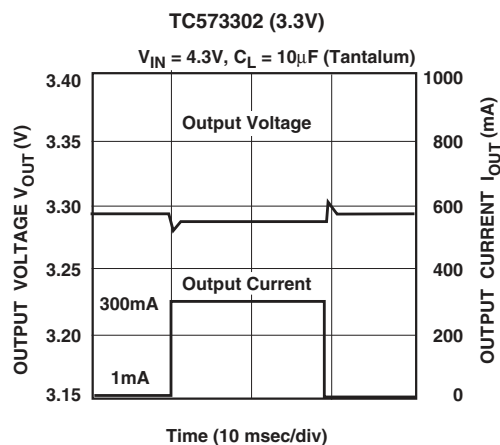
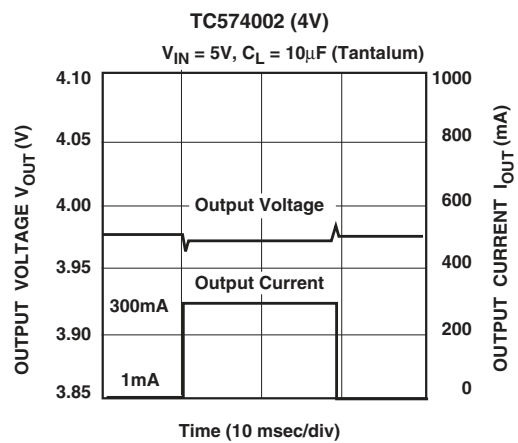
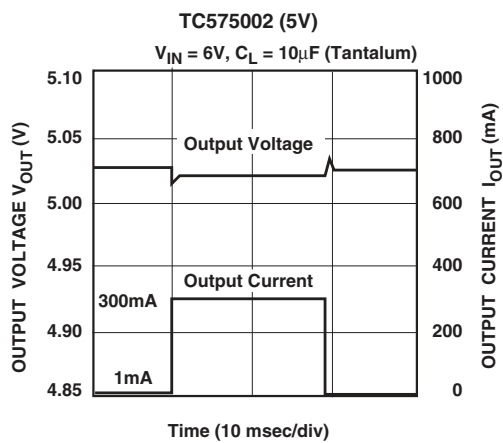

TC57

5.0 PACKAGING INFORMATION

5.1 Package Marking Information

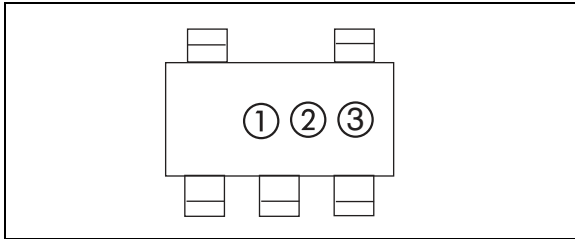

① represents integer part of output voltage

Symbol	Voltage
2	2.
3	3.
4	4.
5	5.
6	6.

② represents first decimal of output voltage

Symbol	Voltage	Symbol	Voltage
0	.0	5	.5
1	.1	6	.6
2	.2	7	.7
3	.3	8	.8
4	.4	9	.9

③ represents production lot ID code

5.2 Taping Form

Component Taping Orientation for 5-Pin SOT-23A (EIAJ SC-74A) Devices

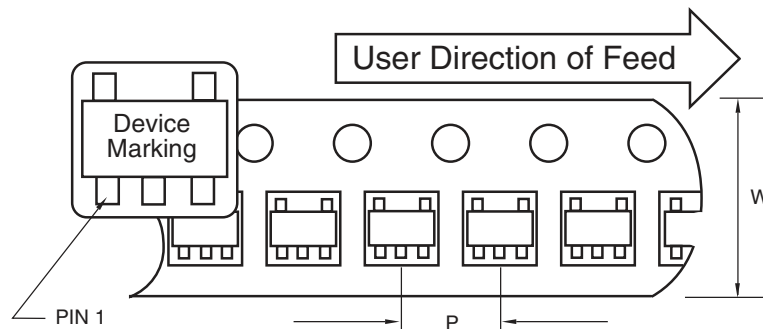

Standard Reel Component Orientation
TR Suffix Device
(Mark Right Side Up)

Carrier Tape, Number of Components Per Reel and Reel Size

Package	Carrier Width (W)	Pitch (P)	Part Per Full Reel	Reel Size
5-Pin SOT-23A	8 mm	4 mm	3000	7 in

5.3 Package Dimensions

Note: For the most current package drawings, please see the Microchip Packaging Specification located at <http://www.microchip.com/packaging>

SOT-23A-5

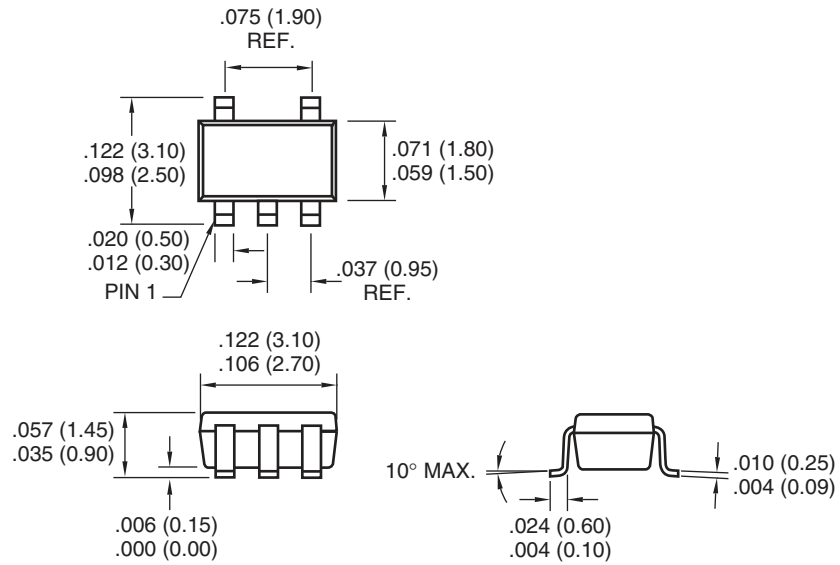

Dimensions: inches (mm)

6.0 REVISION HISTORY

Revision C (November 2012)

Added a note to the package outline drawing.

PRODUCT IDENTIFICATION SYSTEM

To order or obtain information, e.g., on pricing or delivery, refer to the factory or the listed sales office.

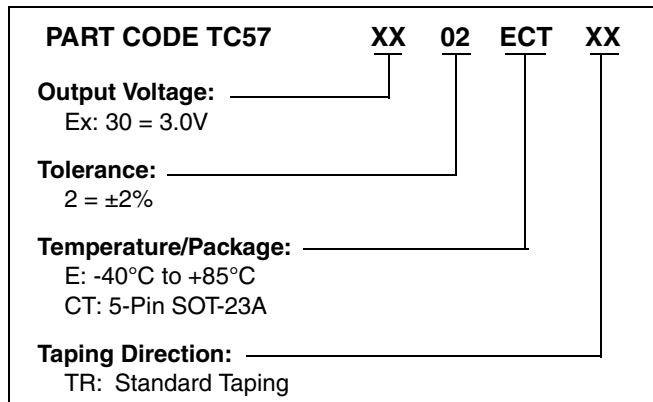

Sales and Support

Data Sheets

Products supported by a preliminary Data Sheet may have an errata sheet describing minor operational differences and recommended workarounds. To determine if an errata sheet exists for a particular device, please contact one of the following:

1. Your local Microchip sales office
2. The Microchip Worldwide Site (www.microchip.com)

Please specify which device, revision of silicon and Data Sheet (include Literature #) you are using.

New Customer Notification System

Register on our web site (www.microchip.com/cn) to receive the most current information on our products.

TC57

NOTES:

Note the following details of the code protection feature on Microchip devices:

- Microchip products meet the specification contained in their particular Microchip Data Sheet.
- Microchip believes that its family of products is one of the most secure families of its kind on the market today, when used in the intended manner and under normal conditions.
- There are dishonest and possibly illegal methods used to breach the code protection feature. All of these methods, to our knowledge, require using the Microchip products in a manner outside the operating specifications contained in Microchip's Data Sheets. Most likely, the person doing so is engaged in theft of intellectual property.
- Microchip is willing to work with the customer who is concerned about the integrity of their code.
- Neither Microchip nor any other semiconductor manufacturer can guarantee the security of their code. Code protection does not mean that we are guaranteeing the product as “unbreakable.”

Code protection is constantly evolving. We at Microchip are committed to continuously improving the code protection features of our products. Attempts to break Microchip's code protection feature may be a violation of the Digital Millennium Copyright Act. If such acts allow unauthorized access to your software or other copyrighted work, you may have a right to sue for relief under that Act.

Information contained in this publication regarding device applications and the like is provided only for your convenience and may be superseded by updates. It is your responsibility to ensure that your application meets with your specifications. MICROCHIP MAKES NO REPRESENTATIONS OR WARRANTIES OF ANY KIND WHETHER EXPRESS OR IMPLIED, WRITTEN OR ORAL, STATUTORY OR OTHERWISE, RELATED TO THE INFORMATION, INCLUDING BUT NOT LIMITED TO ITS CONDITION, QUALITY, PERFORMANCE, MERCHANTABILITY OR FITNESS FOR PURPOSE. Microchip disclaims all liability arising from this information and its use. Use of Microchip devices in life support and/or safety applications is entirely at the buyer's risk, and the buyer agrees to defend, indemnify and hold harmless Microchip from any and all damages, claims, suits, or expenses resulting from such use. No licenses are conveyed, implicitly or otherwise, under any Microchip intellectual property rights.

Trademarks

The Microchip name and logo, the Microchip logo, dsPIC, FlashFlex, KEELOQ, KEELOQ logo, MPLAB, PIC, PICmicro, PICSTART, PIC³² logo, rPIC, SST, SST Logo, SuperFlash and UNI/O are registered trademarks of Microchip Technology Incorporated in the U.S.A. and other countries.

FilterLab, Hampshire, HI-TECH C, Linear Active Thermistor, MTP, SEEVAL and The Embedded Control Solutions Company are registered trademarks of Microchip Technology Incorporated in the U.S.A.

Silicon Storage Technology is a registered trademark of Microchip Technology Inc. in other countries.

Analog-for-the-Digital Age, Application Maestro, BodyCom, chipKIT, chipKIT logo, CodeGuard, dsPICDEM, dsPICDEM.net, dsPICworks, dsSPEAK, ECAN, ECONOMONITOR, FanSense, HI-TIDE, In-Circuit Serial Programming, ICSP, Mindi, MiWi, MPASM, MPF, MPLAB Certified logo, MPLIB, MPLINK, mTouch, Omniclient Code Generation, PICC, PICC-18, PICDEM, PICDEM.net, PICkit, PICtail, REAL ICE, rLAB, Select Mode, SQI, Serial Quad I/O, Total Endurance, TSHARC, UniWinDriver, WiperLock, ZENA and Z-Scale are trademarks of Microchip Technology Incorporated in the U.S.A. and other countries.

SQTP is a service mark of Microchip Technology Incorporated in the U.S.A.

GestIC and ULPP are registered trademarks of Microchip Technology Germany II GmbH & Co. & KG, a subsidiary of Microchip Technology Inc., in other countries.

All other trademarks mentioned herein are property of their respective companies.

© 2001-2012, Microchip Technology Incorporated, Printed in the U.S.A., All Rights Reserved.

 Printed on recycled paper.

ISBN: 9781620767436

QUALITY MANAGEMENT SYSTEM
CERTIFIED BY DNV
== ISO/TS 16949 ==

Microchip received ISO/TS-16949:2009 certification for its worldwide headquarters, design and wafer fabrication facilities in Chandler and Tempe, Arizona; Gresham, Oregon and design centers in California and India. The Company's quality system processes and procedures are for its PIC[®] MCUs and dsPIC[®] DSCs, KEELOQ[®] code hopping devices, Serial EEPROMs, microperipherals, nonvolatile memory and analog products. In addition, Microchip's quality system for the design and manufacture of development systems is ISO 9001:2000 certified.



MICROCHIP

Worldwide Sales and Service

AMERICAS

Corporate Office
2355 West Chandler Blvd.
Chandler, AZ 85224-6199
Tel: 480-792-7200
Fax: 480-792-7277
Technical Support:
<http://www.microchip.com/support>
Web Address:
www.microchip.com

Atlanta
Duluth, GA
Tel: 678-957-9614
Fax: 678-957-1455

Boston
Westborough, MA
Tel: 774-760-0087
Fax: 774-760-0088

Chicago
Itasca, IL
Tel: 630-285-0071
Fax: 630-285-0075

Cleveland
Independence, OH
Tel: 216-447-0464
Fax: 216-447-0643

Dallas
Addison, TX
Tel: 972-818-7423
Fax: 972-818-2924

Detroit
Farmington Hills, MI
Tel: 248-538-2250
Fax: 248-538-2260

Indianapolis
Noblesville, IN
Tel: 317-773-8323
Fax: 317-773-5453

Los Angeles
Mission Viejo, CA
Tel: 949-462-9523
Fax: 949-462-9608

Santa Clara
Santa Clara, CA
Tel: 408-961-6444
Fax: 408-961-6445

Toronto
Mississauga, Ontario,
Canada
Tel: 905-673-0699
Fax: 905-673-6509

ASIA/PACIFIC

Asia Pacific Office
Suites 3707-14, 37th Floor
Tower 6, The Gateway
Harbour City, Kowloon
Hong Kong
Tel: 852-2401-1200
Fax: 852-2401-3431

Australia - Sydney
Tel: 61-2-9868-6733
Fax: 61-2-9868-6755

China - Beijing
Tel: 86-10-8569-7000
Fax: 86-10-8528-2104

China - Chengdu
Tel: 86-28-8665-5511
Fax: 86-28-8665-7889

China - Chongqing
Tel: 86-23-8980-9588
Fax: 86-23-8980-9500

China - Hangzhou
Tel: 86-571-2819-3187
Fax: 86-571-2819-3189

China - Hong Kong SAR
Tel: 852-2401-1200
Fax: 852-2401-3431

China - Nanjing
Tel: 86-25-8473-2460
Fax: 86-25-8473-2470

China - Qingdao
Tel: 86-532-8502-7355
Fax: 86-532-8502-7205

China - Shanghai
Tel: 86-21-5407-5533
Fax: 86-21-5407-5066

China - Shenyang
Tel: 86-24-2334-2829
Fax: 86-24-2334-2393

China - Shenzhen
Tel: 86-755-8203-2660
Fax: 86-755-8203-1760

China - Wuhan
Tel: 86-27-5980-5300
Fax: 86-27-5980-5118

China - Xian
Tel: 86-29-8833-7252
Fax: 86-29-8833-7256

China - Xiamen
Tel: 86-592-2388138
Fax: 86-592-2388130

China - Zhuhai
Tel: 86-756-3210040
Fax: 86-756-3210049

ASIA/PACIFIC

India - Bangalore
Tel: 91-80-3090-4444
Fax: 91-80-3090-4123

India - New Delhi
Tel: 91-11-4160-8631
Fax: 91-11-4160-8632

India - Pune
Tel: 91-20-2566-1512
Fax: 91-20-2566-1513

Japan - Osaka
Tel: 81-66-152-7160
Fax: 81-66-152-9310

Japan - Yokohama
Tel: 81-45-471-6166
Fax: 81-45-471-6122

Korea - Daegu
Tel: 82-53-744-4301
Fax: 82-53-744-4302

Korea - Seoul
Tel: 82-2-554-7200
Fax: 82-2-558-5932 or
82-2-558-5934

Malaysia - Kuala Lumpur
Tel: 60-3-6201-9857
Fax: 60-3-6201-9859

Malaysia - Penang
Tel: 60-4-227-8870
Fax: 60-4-227-4068

Philippines - Manila
Tel: 63-2-634-9065
Fax: 63-2-634-9069

Singapore
Tel: 65-6334-8870
Fax: 65-6334-8850

Taiwan - Hsin Chu
Tel: 886-3-5778-366
Fax: 886-3-5770-955

Taiwan - Kaohsiung
Tel: 886-7-213-7828
Fax: 886-7-330-9305

Taiwan - Taipei
Tel: 886-2-2508-8600
Fax: 886-2-2508-0102

Thailand - Bangkok
Tel: 66-2-694-1351
Fax: 66-2-694-1350

EUROPE

Austria - Wels
Tel: 43-7242-2244-39
Fax: 43-7242-2244-393

Denmark - Copenhagen
Tel: 45-4450-2828
Fax: 45-4485-2829

France - Paris
Tel: 33-1-69-53-63-20
Fax: 33-1-69-30-90-79

Germany - Munich
Tel: 49-89-627-144-0
Fax: 49-89-627-144-44

Italy - Milan
Tel: 39-0331-742611
Fax: 39-0331-466781

Netherlands - Drunen
Tel: 31-416-690399
Fax: 31-416-690340

Spain - Madrid
Tel: 34-91-708-08-90
Fax: 34-91-708-08-91

UK - Wokingham
Tel: 44-118-921-5869
Fax: 44-118-921-5820

10/26/12