

CSPB40K-HF

Reverse Voltage: 800 Volts

Forward Current: 4.0 A

RoHS Device

Halogen Free



Features

- Planar passivated chips.
- Ultra low leakage reverse current.
- High temperature performance.
- High surge current capability.
- Ideal for printed circuit boards.
- High temperature soldering guaranteed: 260°C/10 seconds.

Mechanical data

- Case: SPB molded plastic.
- Molding compound, UL flammability classification rating 94V-0.
- Terminals: Leads solderable per MIL-STD-750,
- Mounting position: Any.

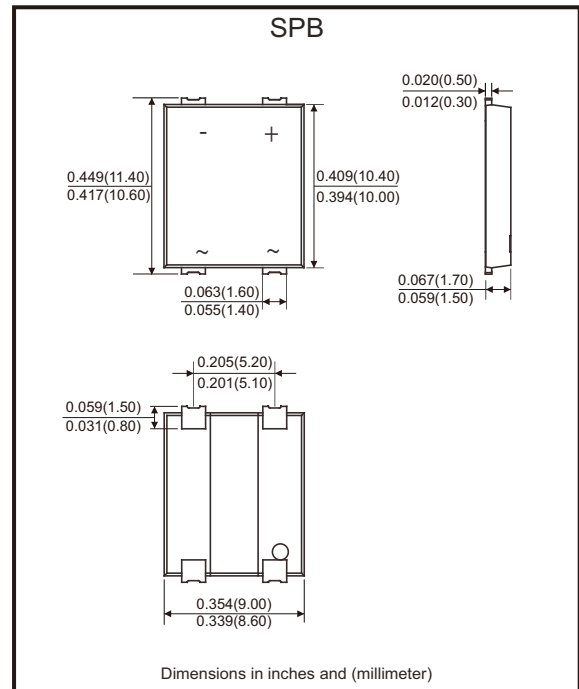

Circuit diagram

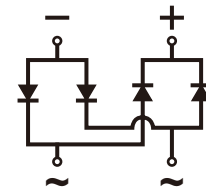

Maximum Ratings (at Ta=25 °C unless otherwise specified)

Characteristic	Symbol	CSPB40K-HF	Units
Peak repetitive reverse voltage	V_{RRM}	800	V
RMS reverse voltage	V_{RMS}	560	V
DC blocking voltage	V_{DC}	800	V
Maximum average forward output current	$I_{F(AV)}$	4	A
Peak forward surge current, 8.3ms single half-sine-wave	@T _J =25°C I_{FSM}	135	A
I ² t rating for fusing	@T _J =25°C I^2t	76	A ² s

Thermal Characteristics

Characteristic	Symbol	CSPB40K-HF	Units
Typical thermal resistance per leg (Note 1)	$R_{\theta JA}$	38	°C/W
	$R_{\theta JC}$	10.4	
	$R_{\theta JL}$	7.5	
Operating junction temperature range	T_J	-55 ~ +150	°C
Storage temperature range	T_{STG}	-55 ~ +150	°C

Note: 1. Device mounted on PCB with 10mm x 20mm x 0.1mm copper pad areas.

Electrical Characteristics (at Ta=25 °C unless otherwise specified)

Parameter	Symbol	Test conditions	Typ.	Max.	Units	
Max. instantaneous forward voltage	V _F	I _F = 2.0A Per diode	0.91	0.95	V	
		I _F = 4.0A Per diode	0.95	1.0		
Max. reverse current	I _R	Rated V _R , Per diode	@T _A =25°C	0.5	1.0	μA
			@T _A =150°C	40	100	

Rating and Characteristic Curves (CSPB40K-HF)

Fig.1 - Forward Current Derating Curve

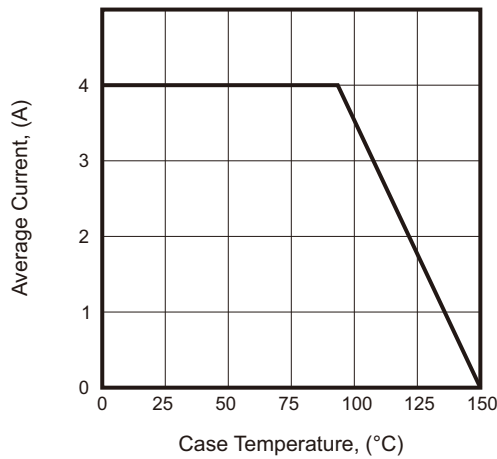

Fig.2 - Surge Current Derating Curve

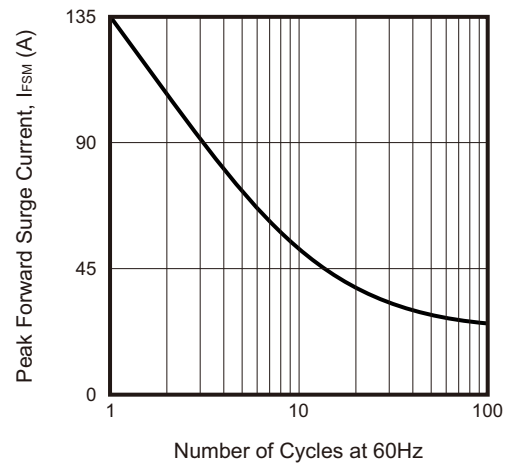

Fig.3 - Typical Forward Voltage Characteristic

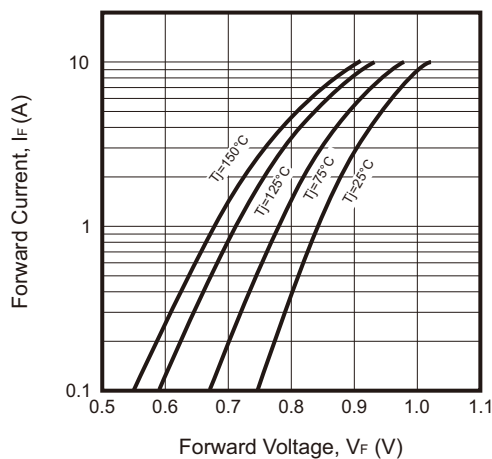
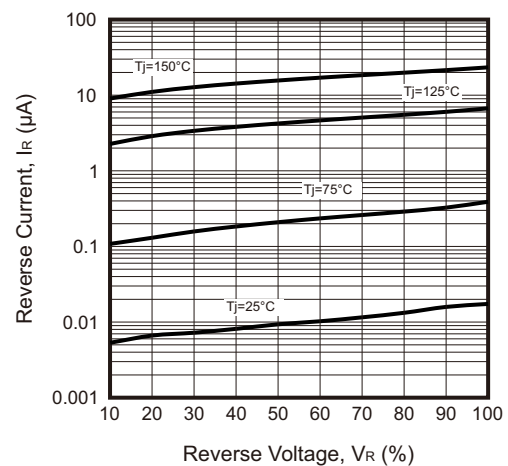
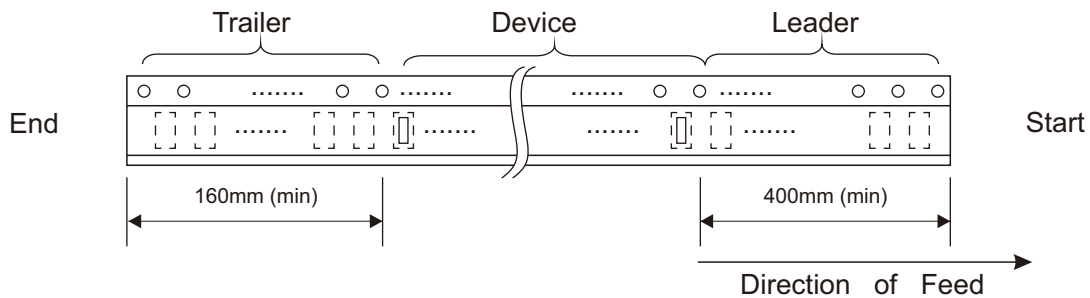
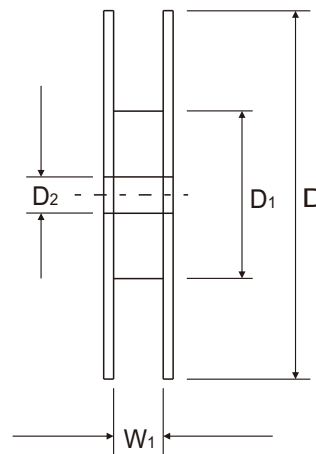
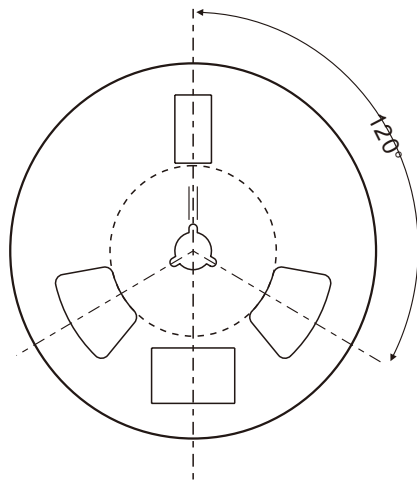
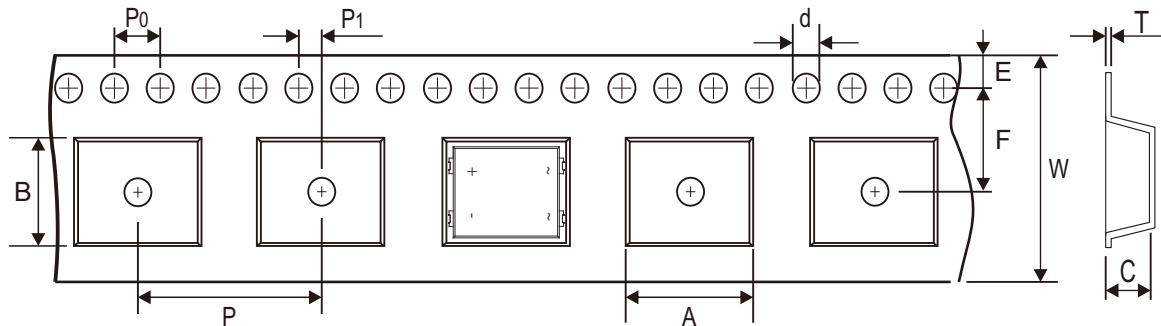

Fig.4 - Typical Reverse Characteristic



Reel Taping Specification



SPB	SYMBOL	A	B	C	d	D	D1	D2
	(mm)	11.30 ± 0.10	9.00 ± 0.10	1.80 ± 0.10	1.50 ± 0.10	330.00 ± 1.00	75.00 ± 1.00	13.50 ± 0.05
	(inch)	0.445 ± 0.004	0.354 ± 0.004	0.071 ± 0.004	0.059 ± 0.004	12.992 ± 0.039	2.953 ± 0.039	0.531 ± 0.002

SPB	SYMBOL	E	F	P	P0	P1	T	W	W1
	(mm)	1.75 ± 0.10	7.50 ± 0.05	16.00 ± 0.05	4.00 ± 0.05	2.00 ± 0.05	0.30 ± 0.05	16.00 ± 0.10	17.00 ± 1.00
	(inch)	0.069 ± 0.004	0.295 ± 0.002	0.630 ± 0.002	0.157 ± 0.002	0.079 ± 0.002	0.012 ± 0.002	0.630 ± 0.004	0.669 ± 0.039

Company reserves the right to improve product design, functions and reliability without notice.

REV:A

Marking Code

Part Number	Marking code
CSPB40K-HF	SPB40K

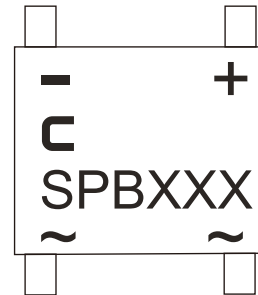

XXX = Product type marking code
C = Comchip Logo

Suggested PAD Layout

SIZE	SPB	
	(mm)	(inch)
A	1.63	0.064
B	1.87	0.074
C	5.10	0.201
D	11.80	0.465

Note: 1. The pad layout is for reference purposes only.

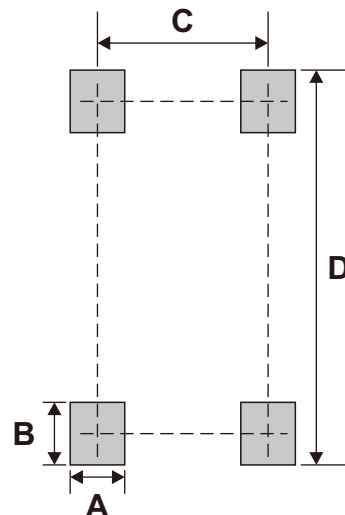

Standard Packaging

Case Type	REEL PACK	
	REEL (pcs)	Reel Size (inch)
SPB	1,500	13