

**Series PVR33**

Microelectronic Power IC  
 BOSFET® Photovoltaic Relay  
 Dual-Pole, 180mA, 0-300V AC/DC

**General Description**

The PVR33 Photovoltaic Relay is a dual-pole, normally open solid state replacement for electro-mechanical relays. It utilizes as an output switch a unique bidirectional (AC or DC) MOSFET power IC termed a BOSFET. The BOSFET is controlled by a photovoltaic generator of novel construction, which is energized by radiation from a dielectrically isolated light emitting diode (LED).

The PVR overcomes the limitations of reed relays by offering the solid state advantages of long life, high operating speed, low pick-up power, bounce-free operation, low thermal voltages and miniaturization. These advantages allow product improvement and design innovations in many applications such as process control, multiplexing, telecommunications, automatic test equipment and data acquisition.

The PVR can switch analog signals from thermocouple level to 300 volts peak AC or DC polarity. Signal frequencies into the RF range are easily controlled and switching rates up to 5kHz are achievable. The extremely small thermally generated offset voltages allow increased measurement accuracies.

Unique silicon technology developed by International Rectifier forms the heart of the PVR. The monolithic BOSFET contains a bidirectional N-channel power MOSFET output structure. In addition, this power IC chip has input circuitry for fast turn-off and gate protection functions. This section of the BOSFET chip utilizes both bipolar and MOS technology to form NPN transistors, P-channel MOSFETs, resistors, diodes and capacitors.

The photovoltaic generator similarly utilizes a unique International Rectifier alloyed multijunction structure. The excellent current conversion efficiency of this technique results in the very fast response of the PVR microelectronic power IC relay.

This advanced semiconductor technology has created a radically new control device. Designers can now develop switching systems to new standards of electrical performance and mechanical compactness.

**Features**

- BOSFET Power IC ■
- 10<sup>10</sup> Operations ■
- 100µsec Operating Time ■
- 0.2µVolt Thermal Offset ■
- 5 milliwatts Pick-Up Power ■
- 1000V/µsec dv/dt ■
- Bounce-Free ■
- 16-pin DIP Package ■
- 40°C to 85°C ■

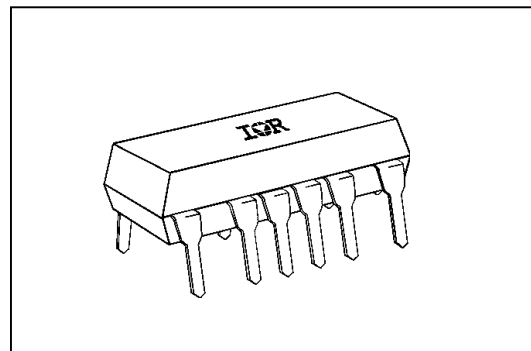

**Part Identification**

Part Number	Operating Voltage (AC/DC)	Off-State Resistance
PVR2300	0 – 200V	10 <sup>8</sup> Ohms
PVR3300	0 – 300V	10 <sup>8</sup> Ohms
PVR3301	0 – 300V	10 <sup>10</sup> Ohms

(BOSFET is a trademark of International Rectifier)

**Electrical Specifications** ( $-40^{\circ}\text{C} \leq T_A \leq +85^{\circ}\text{C}$  unless otherwise specified)

INPUT CHARACTERISTICS		Units
Minimum Control Current (see figure 1)		DC
For 20mA Continuous Load Current	2.0	mA@25°C
For 100mA Continuous Load Current	5.0	mA@25°C
For 20mA Continuous Load Current	5.0	mA@85°C
Minimum Turn-Off Current	10	μA(DC)
Minimum Turn-Off Voltage	0.6	V(DC)
Control Current Range (Caution: current limit input LED. See figure 6)	2.0 to 25	mA(DC)
Maximum Reverse Voltage	7.0	V(DC)

OUTPUT CHARACTERISTICS	PVR2300	PVR3300, PVR3301	Units
Operating Voltage Range	±200	±300	V <sub>(peak)</sub>
Maximum Load Current 40°C (see figure 1)			
AC (A Connection)	180		mA (peak)
DC (B Connection)	200		mA(DC)
DC (C Connection)	260		mA(DC)
Response Time @25°C (see figure 7)			
Maximum T <sub>(on)</sub> @ 12mA Control, 100 mA Load, 100 VDC	150		μs
Maximum T <sub>(off)</sub> @ 12mA Control, 100 mA Load, 100 VDC	50		μs
Maximum On-state Resistance 25°C (Pulsed) (fig. 2) 50 mA Load, 8mA Control			
AC (A Connection)	24		Ω
DC (B Connection)	12		Ω
DC (C Connection)	6		Ω
Minimum Off-state Resistance 25°C @ 160 VDC PVR2300, PVR3300	10 <sup>9</sup>		Ω
@ 240 VDC PVR3301	10 <sup>10</sup>		Ω
Maximum Thermal Offset Voltage @ 5.0mA Control	0.2		μvolts
Minimum Off-State dv/dt	1000		V/μs
Output Capacitance (see figure 3)	12		pF @ 50VDC

GENERAL CHARACTERISTICS (PVR2300, PVR3300, PVR1301)		Units
Dielectric Strength: Input-Output	1500	V <sub>RMS</sub>
Insulation Resistance: Input-Output @ 500V <sub>DC</sub>	10 <sup>9</sup>	Ω
Maximum Capacitance: Input-Output	1.0	pF
Maximum Lead Soldering Temperature (1.6mm below seating plane for 10 sec.)	260	°C
Ambient Temperature Range:		
Operating	-40 to +85	°C
Storage	-40 to +100	

Replaced by PVR33N

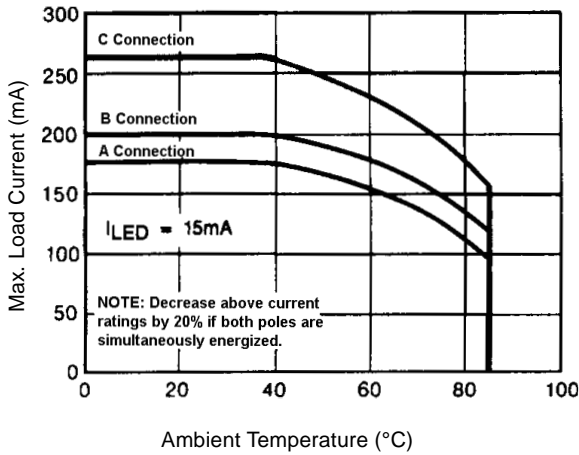

Figure 1. Current Derating Curve

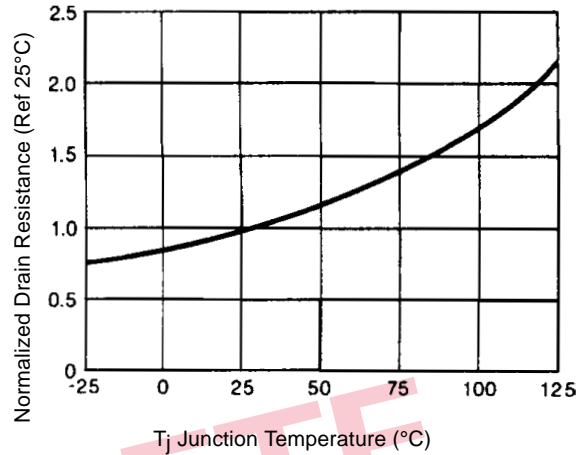

Figure 2. Typical Normalized On-Resistance

OBSOLETE

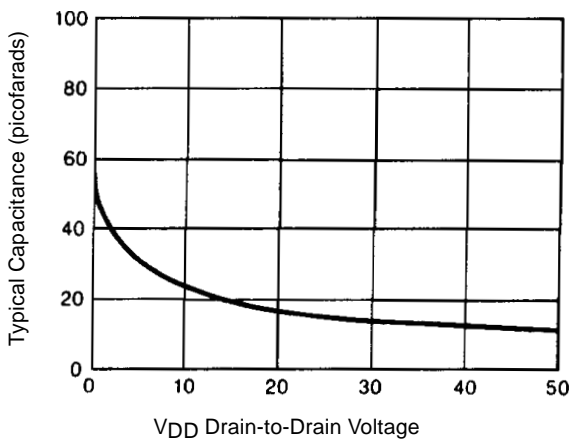

Figure 3. Typical Output Capacitance

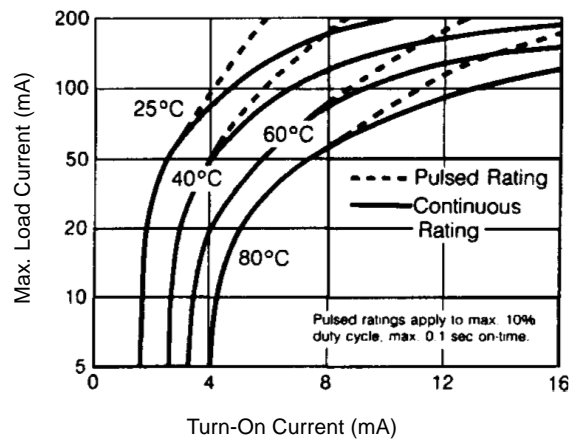

Figure 4. Minimum Control Current for Full Turn-On

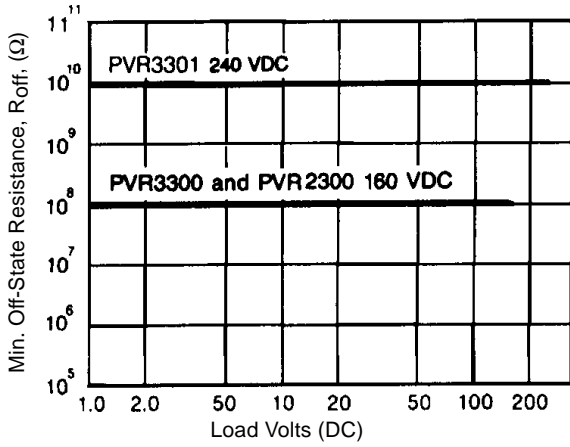

Figure 5. Off-State Resistance

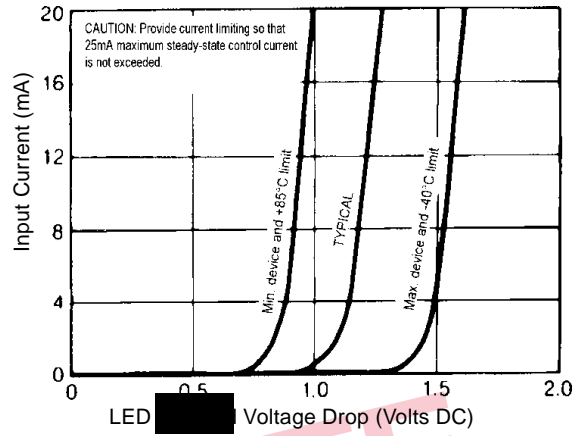

Figure 6. Input Characteristics (Current Controlled)

OBSOLETE

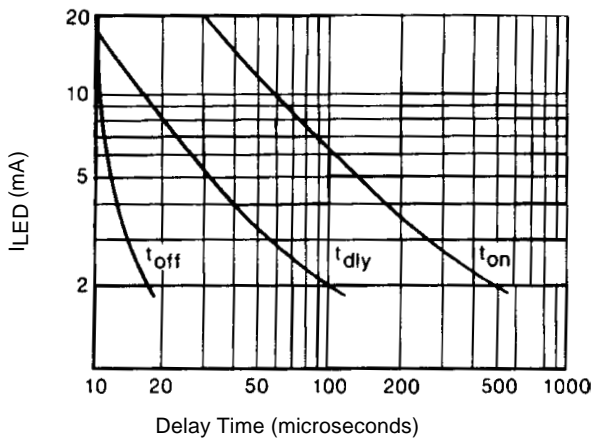

Figure 7. Typical Delay Times

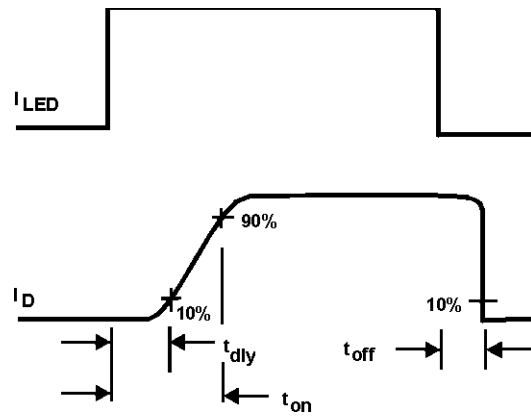
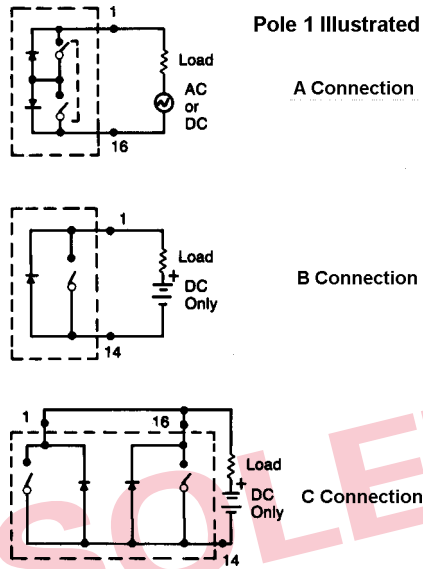

Figure 8. Delay Time Definitions

**Replaced by PVR33N**

**Wiring Diagram**



**Schematic Diagram**

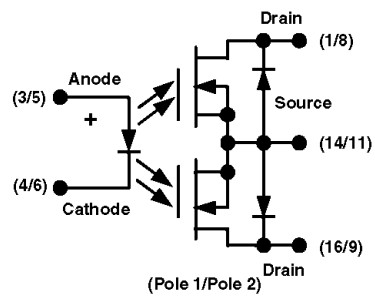

**Case Outline**

(Dimensions in inches (millimeters))

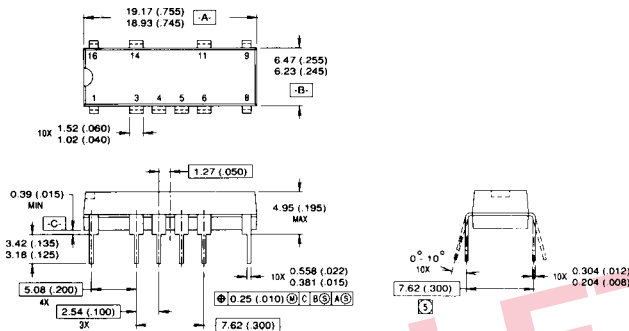

OBSOLETE

**Mechanical Specifications:**

- Package: 16-pin DIP
- Tolerances: .015 (.38) unless otherwise specified
- Case Material: molded epoxy