

# UTWE 6/3+1 - Test terminal strip



3069047

<https://www.phoenixcontact.com/us/products/3069047>

Please be informed that the data shown in this PDF document is generated from our online catalog. Please find the complete data in the user documentation. Our general terms of use for downloads are valid.



Test terminal strip, nom. voltage: 400 V, nominal current: 24 A, number of connections: 8, number of positions: 4, connection method: Screw connection, 1 level, Rated cross section: 6 mm<sup>2</sup>, cross section: 0.2 mm<sup>2</sup> - 10 mm<sup>2</sup>, mounting type: Wall mounting, color: gray

## Your advantages

- The automatically generated transformer short circuit and the shock-proof design ensure the highest degree of safety during measurement
- The integrated, robust switch contact is designed for the most stringent demands, and the use of high-quality materials ensures the transmission of signal currents, even after multiple actuations

## Commercial data

Item number	3069047
Packing unit	1 pc
Minimum order quantity	5 pc
Sales key	BE06
Product key	BE6111
Catalog page	Page 614 (C-1-2019)
GTIN	4055626114835
Weight per piece (including packing)	196.06 g
Weight per piece (excluding packing)	196.06 g
Customs tariff number	85369010
Country of origin	PL

# UTWE 6/3+1 - Test terminal strip



3069047

<https://www.phoenixcontact.com/us/products/3069047>

## Technical data

### Product properties

Product type	Test terminal strip
Number of positions	4
Pitch	8.2 mm
Number of connections	8
Number of rows	1
Potentials	4

### Insulation characteristics

Overvoltage category	III
----------------------	-----

### Electrical properties

Rated surge voltage	4 kV
Maximum power dissipation for nominal condition	1.31 W
Test surge voltage	5 kV

### Connection data

Nominal cross section	6 mm <sup>2</sup>
-----------------------	-------------------

#### 1 level

Screw thread	M4
Tightening torque	1.5 ... 1.8 Nm
Stripping length	10 mm
Internal cylindrical gage	A5
Connection in acc. with standard	IEC 60947-7-1
Conductor cross section rigid	0.2 mm <sup>2</sup> ... 10 mm <sup>2</sup>
Cross section AWG	24 ... 8 (converted acc. to IEC)
Conductor cross section flexible	0.2 mm <sup>2</sup> ... 10 mm <sup>2</sup>
Conductor cross section, flexible [AWG]	24 ... 8 (converted acc. to IEC)
Conductor cross-section flexible (ferrule without plastic sleeve)	0.25 mm <sup>2</sup> ... 6 mm <sup>2</sup>
Flexible conductor cross section (ferrule with plastic sleeve)	0.25 mm <sup>2</sup> ... 6 mm <sup>2</sup>
2 conductors with same cross section, solid	0.2 mm <sup>2</sup> ... 2.5 mm <sup>2</sup>
2 conductors with same cross section, flexible	0.2 mm <sup>2</sup> ... 2.5 mm <sup>2</sup>
2 conductors with same cross section, flexible, with ferrule without plastic sleeve	0.25 mm <sup>2</sup> ... 1.5 mm <sup>2</sup>
2 conductors with the same cross section, flexible, with TWIN ferrule with plastic sleeve	0.5 mm <sup>2</sup> ... 2.5 mm <sup>2</sup>
Nominal current	24 A
Maximum load current	30 A (with 10 mm <sup>2</sup> conductor cross section)
Nominal voltage	400 V
Nominal cross section	6 mm <sup>2</sup>

### Dimensions



# UTWE 6/3+1 - Test terminal strip



3069047

<https://www.phoenixcontact.com/us/products/3069047>

## Power-frequency withstand voltage

Test voltage setpoint	1.89 kV
Result	Test passed

## Mechanical properties

### General

Terminal block mounting	0.8 Nm ... 1 Nm
-------------------------	-----------------

### Mechanical data

Open side panel	No
-----------------	----

## Mechanical tests

### Mechanical strength

Result	Test passed
--------	-------------

### Attachment on the carrier

DIN rail/fixing support	Panel cutout
Test force setpoint	5 N
Result	Test passed
Note	Dimensions panel cutout see appendix.

### Test for conductor damage and slackening

Rotation speed	10 rpm
Revolutions	135
Conductor cross section/weight	0.2 mm <sup>2</sup> / 0.2 kg
	6 mm <sup>2</sup> / 1.4 kg
	10 mm <sup>2</sup> / 2 kg
Result	Test passed

## Environmental and real-life conditions

### Needle-flame test

Time of exposure	30 s
Result	Test passed

### Oscillation/broadband noise

Specification	DIN EN 50155 (VDE 0115-200):2008-03
Spectrum	Service life test category 1, class B, body mounted
Frequency	$f_1 = 5 \text{ Hz}$ to $f_2 = 150 \text{ Hz}$
ASD level	1.857 (m/s <sup>2</sup> )/Hz
Acceleration	0.8g
Test duration per axis	5 h
Test directions	X-, Y- and Z-axis
Result	Test passed

### Shocks

# UTWE 6/3+1 - Test terminal strip



3069047

<https://www.phoenixcontact.com/us/products/3069047>

Specification	DIN EN 50155 (VDE 0115-200):2008-03
Pulse shape	Half-sine
Acceleration	5g
Shock duration	30 ms
Number of shocks per direction	3
Test directions	X-, Y- and Z-axis (pos. and neg.)
Result	Test passed

## Ambient conditions

Ambient temperature (operation)	-60 °C ... 105 °C (max. short-term operating temperature RTI Elec.)
Ambient temperature (storage/transport)	-25 °C ... 60 °C (for a short time, not exceeding 24 h, -60 °C to +70 °C)
Ambient temperature (assembly)	-5 °C ... 70 °C
Ambient temperature (actuation)	-5 °C ... 70 °C
Permissible humidity (storage/transport)	30 % ... 70 %

## Standards and regulations

Connection in acc. with standard	IEC 60947-7-1
----------------------------------	---------------

## Mounting

Mounting type	Wall mounting
Plate thickness	1 mm ... 4 mm
Terminal block mounting	0.8 Nm ... 1 Nm

# UTWE 6/3+1 - Test terminal strip



3069047

<https://www.phoenixcontact.com/us/products/3069047>

## Drawings

Dimensional drawing

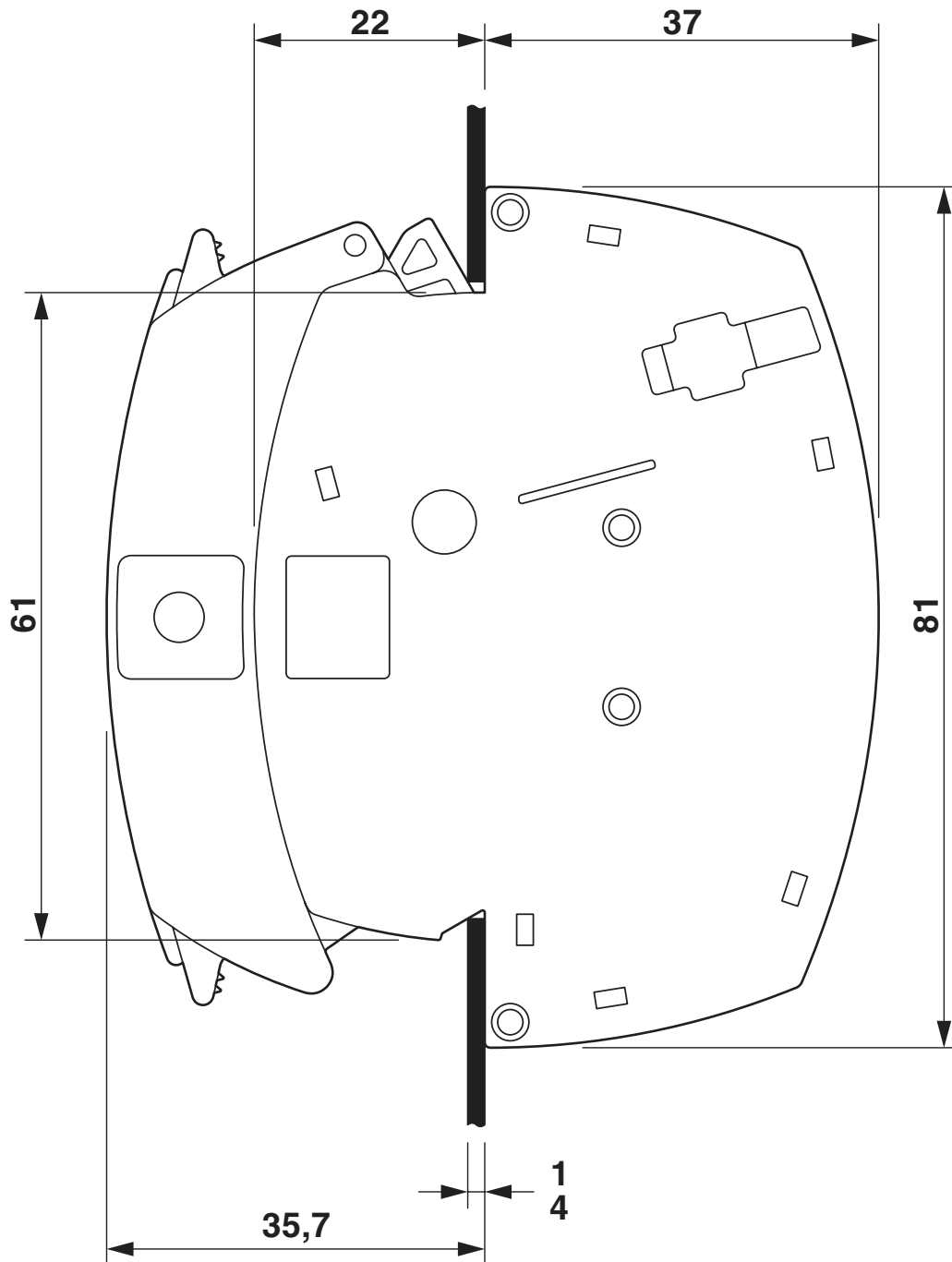

# UTWE 6/3+1 - Test terminal strip

3069047

<https://www.phoenixcontact.com/us/products/3069047>



Circuit diagram

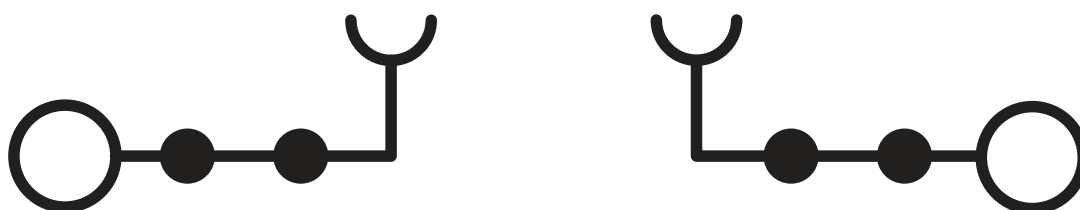

Dimensional drawing

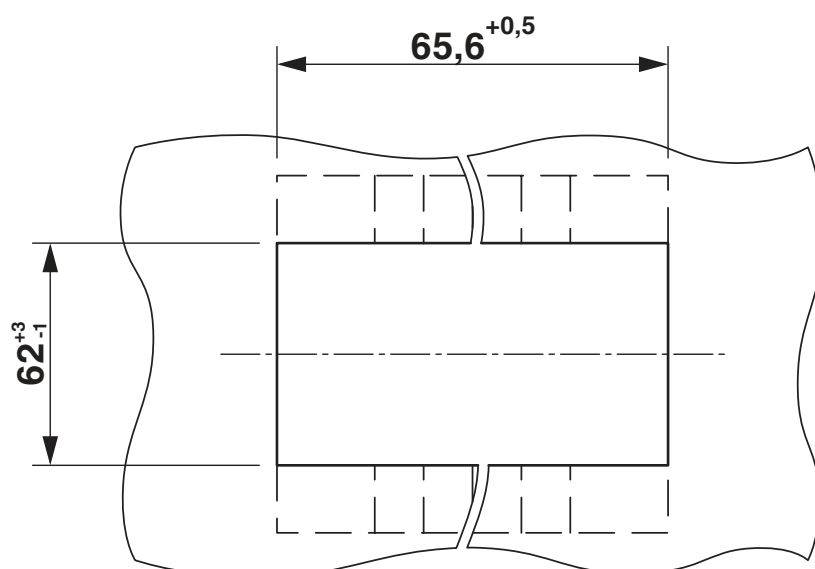

# UTWE 6/3+1 - Test terminal strip





3069047

<https://www.phoenixcontact.com/us/products/3069047>

## Approvals

To download certificates, visit the product detail page: <https://www.phoenixcontact.com/us/products/3069047>

 <b>CSA</b> Approval ID: 013631				
	Nominal voltage $U_N$	Nominal current $I_N$	Cross section AWG	Cross section $mm^2$
Use group D	300 V	10 A	24 - 8	-

 <b>EAC</b> Approval ID: RU C-DE.AI30.B.01102				
---	--	--	--	--

 <b>EAC</b> Approval ID: RU C-DE.BL08.B.00682				
---	--	--	--	--

 <b>cULus Recognized</b> Approval ID: E60425				
	Nominal voltage $U_N$	Nominal current $I_N$	Cross section AWG	Cross section $mm^2$
Use group B	600 V	30 A	24 - 8	-
Use group C	600 V	30 A	24 - 8	-



# UTWE 6/3+1 - Test terminal strip



3069047

<https://www.phoenixcontact.com/us/products/3069047>

## Classifications

### ECLASS

ECLASS-11.0	27141148
ECLASS-12.0	27141148
ECLASS-13.0	27250304

### ETIM

ETIM 8.0	EC002555
----------	----------

### UNSPSC

UNSPSC 21.0	20122000
-------------	----------

# UTWE 6/3+1 - Test terminal strip

3069047

<https://www.phoenixcontact.com/us/products/3069047>



## Environmental product compliance

REACH SVHC

Lead 7439-92-1

# UTWE 6/3+1 - Test terminal strip

3069047

<https://www.phoenixcontact.com/us/products/3069047>

## Accessories

 Note: Applying some accessories below might limit this product.

### FBS 2-8 - Plug-in bridge

3030284

<https://www.phoenixcontact.com/us/products/3030284>



Plug-in bridge, pitch: 8.2 mm, number of positions: 2, color: red

 Max. current carrying capacity: 30 A

---

### FBS 3-8 - Plug-in bridge

3030297

<https://www.phoenixcontact.com/us/products/3030297>



Plug-in bridge, pitch: 8.2 mm, number of positions: 3, color: red

 Max. current carrying capacity: 30 A

# UTWE 6/3+1 - Test terminal strip

3069047

<https://www.phoenixcontact.com/us/products/3069047>



## FBS 4-8 - Plug-in bridge

3030307

<https://www.phoenixcontact.com/us/products/3030307>

Plug-in bridge, pitch: 8.2 mm, number of positions: 4, color: red



 Max. current carrying capacity: 30 A

---

## FBS 5-8 - Plug-in bridge

3030310

<https://www.phoenixcontact.com/us/products/3030310>

Plug-in bridge, pitch: 8.2 mm, number of positions: 5, color: red



 Max. current carrying capacity: 30 A

# UTWE 6/3+1 - Test terminal strip

3069047

<https://www.phoenixcontact.com/us/products/3069047>



## FBS 10-8 - Plug-in bridge

3030323

<https://www.phoenixcontact.com/us/products/3030323>



Plug-in bridge, pitch: 8.2 mm, number of positions: 10, color: red

 Max. current carrying capacity: 30 A

---

## FBS 6-8 - Plug-in bridge

3032470

<https://www.phoenixcontact.com/us/products/3032470>



Plug-in bridge, pitch: 8.2 mm, number of positions: 6, color: red

 Max. current carrying capacity: 30 A

# UTWE 6/3+1 - Test terminal strip

3069047

<https://www.phoenixcontact.com/us/products/3069047>



## FBS 1/3-8 - Plug-in bridge

3032363

<https://www.phoenixcontact.com/us/products/3032363>



Plug-in bridge, pitch: 8.2 mm, number of positions: 3, pin assignment: 1,3, color: red

 Max. current carrying capacity: 30 A

---

## FBS 1/4-8 - Plug-in bridge

3032376

<https://www.phoenixcontact.com/us/products/3032376>



Plug-in bridge, pitch: 8.2 mm, number of positions: 4, pin assignment: 1, 4, color: red

 Max. current carrying capacity: 30 A

# UTWE 6/3+1 - Test terminal strip

3069047

<https://www.phoenixcontact.com/us/products/3069047>



## FBS 1/3/5-8 - Plug-in bridge

3032389

<https://www.phoenixcontact.com/us/products/3032389>



Plug-in bridge, pitch: 8.2 mm, number of positions: 5, pin assignment: 1,3,5, color: red

 Max. current carrying capacity: 30 A

---

## FBS 1/4/7/10-8 - Plug-in bridge

3032402

<https://www.phoenixcontact.com/us/products/3032402>



Plug-in bridge, pitch: 8.2 mm, number of positions: 10, pin assignment: 1,4,7,10, color: red

 Max. current carrying capacity: 30 A

# UTWE 6/3+1 - Test terminal strip

3069047

<https://www.phoenixcontact.com/us/products/3069047>



## FBS 1/5-8 - Plug-in bridge

3032381

<https://www.phoenixcontact.com/us/products/3032381>



Plug-in bridge, pitch: 8.2 mm, number of positions: 5, pin assignment: 1,5, color: red

 Max. current carrying capacity: 30 A

---

## FBS 2-8 CT - Plug-in bridge

3033830

<https://www.phoenixcontact.com/us/products/3033830>



Plug-in bridge, pitch: 8.2 mm, number of positions: 2, color: orange

 Max. current carrying capacity: 30 A



# UTWE 6/3+1 - Test terminal strip

3069047

<https://www.phoenixcontact.com/us/products/3069047>



## FBS 3-8 CT - Plug-in bridge

3033831

<https://www.phoenixcontact.com/us/products/3033831>



Plug-in bridge, pitch: 8.2 mm, number of positions: 3, color: orange

 Max. current carrying capacity: 30 A

---

## FBS 4-8 CT - Plug-in bridge

3033832

<https://www.phoenixcontact.com/us/products/3033832>



Plug-in bridge, pitch: 8.2 mm, number of positions: 4, color: orange

 Max. current carrying capacity: 30 A

# UTWE 6/3+1 - Test terminal strip

3069047

<https://www.phoenixcontact.com/us/products/3069047>



## FBS 10-8 CT - Plug-in bridge

3033833

<https://www.phoenixcontact.com/us/products/3033833>



Plug-in bridge, pitch: 8.2 mm, number of positions: 10, color: orange

 Max. current carrying capacity: 30 A

---

## FBS 2-8 BU - Plug-in bridge

3032567

<https://www.phoenixcontact.com/us/products/3032567>



Plug-in bridge, pitch: 8.2 mm, number of positions: 2, color: blue

 Max. current carrying capacity: 30 A

# UTWE 6/3+1 - Test terminal strip

3069047

<https://www.phoenixcontact.com/us/products/3069047>



## FBS 3-8 BU - Plug-in bridge

3032570

<https://www.phoenixcontact.com/us/products/3032570>



Plug-in bridge, pitch: 8.2 mm, number of positions: 3, color: blue

 Max. current carrying capacity: 30 A

---

## FBS 4-8 BU - Plug-in bridge

3032583

<https://www.phoenixcontact.com/us/products/3032583>



Plug-in bridge, pitch: 8.2 mm, number of positions: 4, color: blue

 Max. current carrying capacity: 30 A

# UTWE 6/3+1 - Test terminal strip

3069047

<https://www.phoenixcontact.com/us/products/3069047>



## FBS 5-8 BU - Plug-in bridge

3032596

<https://www.phoenixcontact.com/us/products/3032596>



Plug-in bridge, pitch: 8.2 mm, number of positions: 5, color: blue

 Max. current carrying capacity: 30 A

---

## FBS 6-8 BU - Plug-in bridge

3032677

<https://www.phoenixcontact.com/us/products/3032677>



Plug-in bridge, pitch: 8.2 mm, number of positions: 6, color: blue

 Max. current carrying capacity: 30 A

# UTWE 6/3+1 - Test terminal strip

3069047

<https://www.phoenixcontact.com/us/products/3069047>



## FBS 10-8 BU - Plug-in bridge

3032606

<https://www.phoenixcontact.com/us/products/3032606>



Plug-in bridge, pitch: 8.2 mm, number of positions: 10, color: blue

 Max. current carrying capacity: 30 A

---

## SF-SL 0,8X4,0-100 - Screwdriver

1212551

<https://www.phoenixcontact.com/us/products/1212551>



Screwdriver, bladed (lasered), size: 0.8 x 4.0 x 100 mm, 2-component grip, with non-slip grip

## UTWE 6/3+1 - Test terminal strip

3069047

<https://www.phoenixcontact.com/us/products/3069047>



## SF-SL 0,8X4,0-100 S-VDE - Screwdriver

1212588

<https://www.phoenixcontact.com/us/products/1212588>



Actuation tool, for ST terminal blocks, VDE insulated, with slimmer insulation integrated in the blade, also suitable for use as a bladed screwdriver, size: 0.8 x 4.0 x 100 mm, 2-component grip, with non-slip grip

---

## FTP 3+1 - Test plug

3069222

<https://www.phoenixcontact.com/us/products/3069222>



Test plug, nom. voltage: 400 V, nominal current: 24 A, connection method: Screw connection, Rated cross section: 2.5 mm<sup>2</sup>, color: gray

# UTWE 6/3+1 - Test terminal strip

3069047

<https://www.phoenixcontact.com/us/products/3069047>



## FWP 3+1 - Power plug

3069270

<https://www.phoenixcontact.com/us/products/3069270>



Power plug, nom. voltage: 400 V, nominal current: 24 A, number of positions: 4,  
Rated cross section: 6 mm<sup>2</sup>, color: gray

---

## FBP 3+1 - Blind plug

3069399

<https://www.phoenixcontact.com/us/products/3069399>



Blind plug, number of positions: 4, color: orange

# UTWE 6/3+1 - Test terminal strip

3069047

<https://www.phoenixcontact.com/us/products/3069047>



## AP RSC-T - Cover profile

3059139

<https://www.phoenixcontact.com/us/products/3059139>



Cover profile, for covering terminal strips, directly snapped onto RBO... and RSC... test disconnect terminal blocks. Length supplied: 1 m

---

## E-UTWE 6 - End clamp

3069055

<https://www.phoenixcontact.com/us/products/3069055>



End clamp, material: PA, color: gray



## UTWE 6/3+1 - Test terminal strip

3069047

<https://www.phoenixcontact.com/us/products/3069047>



## APH-UTWE 6 - Cover profile carrier

3069056

<https://www.phoenixcontact.com/us/products/3069056>

Cover profile carrier, material: PA, color: gray



---

## FTPC 3+1 - Test plug

3069259

<https://www.phoenixcontact.com/us/products/3069259>

Test plug, nom. voltage: 400 V, nominal current: 24 A, number of positions: 4, connection method: Screw connection, Rated cross section: 2.5 mm<sup>2</sup>, color: gray



## UTWE 6/3+1 - Test terminal strip

3069047

<https://www.phoenixcontact.com/us/products/3069047>



## PAI-4-FIX BU - Test adapter

3032729

<https://www.phoenixcontact.com/us/products/3032729>



Test adapter, Touch proof against unintentional direct contact according to DIN EN 50274 when plugged in, for 4 mm test plug and terminal blocks with 8.2 mm pitch, number of positions: 1, color: blue

---

## PAI-4-FIX OG - Test adapter

3034455

<https://www.phoenixcontact.com/us/products/3034455>



4 mm test adapter, for terminal blocks with 8.2 mm pitch

## UTWE 6/3+1 - Test terminal strip

3069047

<https://www.phoenixcontact.com/us/products/3069047>



### PAI-4-FIX YE - Test adapter

3032745

<https://www.phoenixcontact.com/us/products/3032745>



Test adapter, Touch proof against unintentional direct contact according to DIN EN 50274 when plugged in, for 4 mm test plug and terminal blocks with 8.2 mm pitch, number of positions: 1, color: yellow

---

### PAI-4-FIX RD - Test adapter

3032732

<https://www.phoenixcontact.com/us/products/3032732>



Test adapter, Touch proof against unintentional direct contact according to DIN EN 50274 when plugged in, for 4 mm test plug and terminal blocks with 8.2 mm pitch, number of positions: 1, color: red

## UTWE 6/3+1 - Test terminal strip

3069047

<https://www.phoenixcontact.com/us/products/3069047>



## PAI-4-FIX GN - Test adapter

3032758

<https://www.phoenixcontact.com/us/products/3032758>



Test adapter, Touch proof against unintentional direct contact according to DIN EN 50274 when plugged in, for 4 mm test plug and terminal blocks with 8.2 mm pitch, number of positions: 1, color: green

---

## PAI-4-FIX BK - Test adapter

3032774

<https://www.phoenixcontact.com/us/products/3032774>



Test adapter, Touch proof against unintentional direct contact according to DIN EN 50274 when plugged in, for 4 mm test plug and terminal blocks with 8.2 mm pitch, number of positions: 1, color: black

## UTWE 6/3+1 - Test terminal strip

3069047

<https://www.phoenixcontact.com/us/products/3069047>



### PAI-4-FIX GY - Test adapter

3032790

<https://www.phoenixcontact.com/us/products/3032790>



Test adapter, Touch proof against unintentional direct contact according to DIN EN 50274 when plugged in, for 4 mm test plug and terminal blocks with 8.2 mm pitch, number of positions: 1, color: gray

---

### PAI-4-FIX VT - Test adapter

3032761

<https://www.phoenixcontact.com/us/products/3032761>



Test adapter, Touch proof against unintentional direct contact according to DIN EN 50274 when plugged in, for 4 mm test plug and terminal blocks with 4.2 mm .. 8.2 mm pitch, number of positions: 1, color: violet

## UTWE 6/3+1 - Test terminal strip

3069047

<https://www.phoenixcontact.com/us/products/3069047>



## PAI-4-FIX BN - Test adapter

3032787

<https://www.phoenixcontact.com/us/products/3032787>



Test adapter, Touch proof against unintentional direct contact according to DIN EN 50274 when plugged in, for 4 mm test plug and terminal blocks with 8.2 mm pitch, number of positions: 1, color: brown

---

## PAI-4-FIX WH - Test adapter

3032797

<https://www.phoenixcontact.com/us/products/3032797>



4 mm test adapter, for terminal blocks with 8.2 mm pitch

## UTWE 6/3+1 - Test terminal strip

3069047

<https://www.phoenixcontact.com/us/products/3069047>



## PAIS-4-FIX GY - Test adapter

3032791

<https://www.phoenixcontact.com/us/products/3032791>



Test adapter, Touch proof against unintentional direct contact according to DIN EN 50274 when plugged in, for 4 mm test plug and terminal blocks with 5.2 mm, 6.2 mm, and 8.2 mm pitch, number of positions: 1, color: gray

---

## PAIS-4-FIX BK - Test adapter

3032792

<https://www.phoenixcontact.com/us/products/3032792>



Test adapter, Touch proof against unintentional direct contact according to DIN EN 50274 when plugged in, for 4 mm test plug and terminal blocks with 5.2 mm, 6.2 mm, and 8.2 mm pitch, number of positions: 1, color: black

# UTWE 6/3+1 - Test terminal strip

3069047

<https://www.phoenixcontact.com/us/products/3069047>



## PAIS-4-FIX RD - Test adapter

3032793

<https://www.phoenixcontact.com/us/products/3032793>



Test adapter, Do not plug in while the power is connected, for 4 mm test plug and terminal blocks with 5.2 mm, 6.2 mm, and 8.2 mm pitch, number of positions: 1, color: red

---

## PAIS-4-FIX BU - Test adapter

3032798

<https://www.phoenixcontact.com/us/products/3032798>



Test adapter, Touch proof against unintentional direct contact according to DIN EN 50274 when plugged in, for 4 mm test plug and terminal blocks with 5.2 mm, 6.2 mm, and 8.2 mm pitch, number of positions: 1, color: blue



## UTWE 6/3+1 - Test terminal strip

3069047

<https://www.phoenixcontact.com/us/products/3069047>



### PAIS-4-FIX YE - Test adapter

3032799

<https://www.phoenixcontact.com/us/products/3032799>



Test adapter, Touch proof against unintentional direct contact according to DIN EN 50274 when plugged in, for 4 mm test plug and terminal blocks with 5.2 mm, 6.2 mm, and 8.2 mm pitch, number of positions: 1, color: yellow

---

### PAIS-4-FIX GN - Test adapter

3032801

<https://www.phoenixcontact.com/us/products/3032801>



Test adapter, Touch proof against unintentional direct contact according to DIN EN 50274 when plugged in, for 4 mm test plug and terminal blocks with 5.2 mm, 6.2 mm, and 8.2 mm pitch, number of positions: 1, color: green

## UTWE 6/3+1 - Test terminal strip

3069047

<https://www.phoenixcontact.com/us/products/3069047>



## PAIS-4-FIX VT - Test adapter

3032802

<https://www.phoenixcontact.com/us/products/3032802>



Test adapter, Touch proof against unintentional direct contact according to DIN EN 50274 when plugged in, for 4 mm test plug and terminal blocks with 5.2 mm, 6.2 mm, and 8.2 mm pitch, number of positions: 1, color: violet

---

## ZB 8:UNBEDRUCKT - Zack marker strip

1052002

<https://www.phoenixcontact.com/us/products/1052002>



Zack marker strip, Strip, white, unlabeled, can be labeled with: CMS-P1-PLOTTER, PLOTMARK, mounting type: snapped, for terminal block width: 8.2 mm, lettering field size: 10.5 x 8.15 mm, Number of individual labels: 10

## UTWE 6/3+1 - Test terminal strip

3069047

<https://www.phoenixcontact.com/us/products/3069047>



## ZB 8 CUS - Zack marker strip

0825011

<https://www.phoenixcontact.com/us/products/0825011>



Zack marker strip, can be ordered: Strip, white, labeled according to customer specifications, mounting type: snap into tall marker groove, for terminal block width: 8.2 mm, lettering field size: 10.5 x 8.15 mm, Number of individual labels: 10

---

## UC-TM 8 - Marker for terminal blocks

0818072

<https://www.phoenixcontact.com/us/products/0818072>



Marker for terminal blocks, Sheet, white, unlabeled, can be labeled with: BLUEMARK ID COLOR, BLUEMARK ID, BLUEMARK CLED, PLOTMARK, CMS-P1-PLOTTER, mounting type: snapped, for terminal block width: 8.2 mm, lettering field size: 7.6 x 10.5 mm, Number of individual labels: 56

# UTWE 6/3+1 - Test terminal strip

3069047

<https://www.phoenixcontact.com/us/products/3069047>



## UC-TM 8 CUS - Marker for terminal blocks

0824597

<https://www.phoenixcontact.com/us/products/0824597>



Marker for terminal blocks, can be ordered: by sheet, white, labeled according to customer specifications, mounting type: snap into tall marker groove, for terminal block width: 8.2 mm, lettering field size: 7.6 x 10.5 mm, Number of individual labels: 56

---

## UCT-TM 8 - Marker for terminal blocks

0828740

<https://www.phoenixcontact.com/us/products/0828740>



Marker for terminal blocks, Sheet, white, unlabeled, can be labeled with: TOPMARK NEO, TOPMARK LASER, BLUEMARK ID COLOR, BLUEMARK ID, BLUEMARK CLED, THERMOMARK PRIME, THERMOMARK CARD 2.0, THERMOMARK CARD, mounting type: snapped, for terminal block width: 8.2 mm, lettering field size: 7.6 x 10.5 mm, Number of individual labels: 42

# UTWE 6/3+1 - Test terminal strip

3069047

<https://www.phoenixcontact.com/us/products/3069047>



## UCT-TM 8 CUS - Marker for terminal blocks

0829616

<https://www.phoenixcontact.com/us/products/0829616>



Marker for terminal blocks, can be ordered: by sheet, white, labeled according to customer specifications, mounting type: snap into tall marker groove, for terminal block width: 8.2 mm, lettering field size: 7.6 x 10.5 mm, Number of individual labels: 42

---

## ZB 8,LGS:FORTL.ZAHLEN - Zack marker strip

1052015

<https://www.phoenixcontact.com/us/products/1052015>



Zack marker strip, Strip, white, labeled, can be labeled with: CMS-P1-PLOTTER, printed horizontally: consecutive numbers 1 ... 10, 11 ... 20, etc. up to 91 ... 100, mounting type: snapped, for terminal block width: 8.2 mm, lettering field size: 10.5 x 8.15 mm, Number of individual labels: 10

## UTWE 6/3+1 - Test terminal strip

3069047

<https://www.phoenixcontact.com/us/products/3069047>



## ZB 8,QR:FORTL.ZAHLEN - Zack marker strip

1052028

<https://www.phoenixcontact.com/us/products/1052028>



Zack marker strip, Strip, white, labeled, can be labeled with: CMS-P1-PLOTTER, Printed vertically: consecutive numbers 1 ... 10, 11 ... 20, etc. up to 91 ... 100, mounting type: snapped, for terminal block width: 8.2 mm, lettering field size: 10.5 x 8.15 mm, Number of individual labels: 10

## ZB 8,LGS:L1-N,PE - Marker for terminal blocks

1052413

<https://www.phoenixcontact.com/us/products/1052413>



Marker for terminal blocks, Strip, white, labeled, can be labeled with: CMS-P1-PLOTTER, horizontal: L1, L2, L3, N, PE, L1, L2, L3, N, PE, mounting type: snapped, for terminal block width: 8.2 mm, lettering field size: 10.5 x 8.15 mm, Number of individual labels: 10

Phoenix Contact 2023 © - all rights reserved  
<https://www.phoenixcontact.com>

Phoenix Contact USA  
586 Fulling Mill Road  
Middletown, PA 17057, United States  
(+717) 944-1300  
[info@phoenixcon.com](mailto:info@phoenixcon.com)