

DSU-FR EMULATOR

LQFP-64P HEADER

MB2198-128-E

OPERATION MANUAL

PREFACE

Thank you for purchasing the LQFP-64P*¹ header (MB2198-128-E) for the DSU-FR*² emulator. The LQFP-64P header is used in the adapter unit to connect the DSU-FR emulator (MB2198-01-E)*³ and the DSU-FR emulator PGA-401P adapter type 2 (MB2198-130-E)*⁴ to a user system. That uses FUJITSU FR family microcontroller MB91265 series (LQFP-64P).

This manual explains the handling of the LQFP-64P header for the DSU-FR emulator. Before using the MB2198-128-E, be sure to read this manual.

Please contact the sales or support representative for details on the mass production and evaluation MCU models that can be used with this product.

*1 : The lead pitch of PACKAGE (FPT-64P-M09) is 0.65mm and the body size is 12mm × 12mm.

*2 : FR, the abbreviation of FUJITSU RISC controller, is a line of products of FUJITSU MICRO-ELECTRONICS LIMITED.

*3 : Referred to as the “emulator”

*4 : Referred to as the “adapter”

■ Handling and use

The handling and use of this product and notes regarding safety are included in the operation manual of the DSU-FR emulator and the DSU-FR emulator PGA-401P adapter type 2.

Follow the instructions in “DSU-FR EMULATOR MB2198-01-E OPERATION MANUAL” and “DSU-FR EMULATOR PGA-401P ADAPTER TYPE 2 MB2198-130-E OPERATION MANUAL” for the use of this product.

■ European RoHS compliance

Products with a -E suffix on the part number are European RoHS compliant products.

■ Notice on this document

All information included in this document is current as of the date it is issued. Such information is subject to change without any prior notice.

Please confirm the latest relevant information with the sales representatives.

■ Caution of the product described in this document

The following precautions apply to the product described in this manual.



Indicates a feature that, if not used correctly, may result in minor or moderate injuries, and which may cause the customer system to malfunction.

Cuts	This product has parts with sharp points that are exposed. Do not touch edge of the product with your bare hands.
Damage	When connect the header board to the user system, correctly position the index mark (▲) on the NQPACK mounted on the user system with the index mark (▲) on the header board, otherwise the emulator system and user system might be damaged.
Damage	When mounting a mass production MCU, correctly position pin 1, otherwise the mass production MCU and user system might be damaged.

- The contents of this document are subject to change without notice. Customers are advised to consult with sales representatives before ordering.
- The information, such as descriptions of function and application circuit examples, in this document are presented solely for the purpose of reference to show examples of operations and uses of FUJITSU MICROELECTRONICS semiconductor device; FUJITSU MICROELECTRONICS does not warrant proper operation of the device with respect to use based on such information. When you develop equipment incorporating the device based on such information, you must assume any responsibility arising out of such use of the information. FUJITSU MICROELECTRONICS assumes no liability for any damages whatsoever arising out of the use of the information.
- Any information in this document, including descriptions of function and schematic diagrams, shall not be construed as license of the use or exercise of any intellectual property right, such as patent right or copyright, or any other right of FUJITSU MICROELECTRONICS or any third party or does FUJITSU MICROELECTRONICS warrant non-infringement of any third-party's intellectual property right or other right by using such information. FUJITSU MICROELECTRONICS assumes no liability for any infringement of the intellectual property rights or other rights of third parties which would result from the use of information contained herein.
- The products described in this document are designed, developed and manufactured as contemplated for general use, including without limitation, ordinary industrial use, general office use, personal use, and household use, but are not designed, developed and manufactured as contemplated (1) for use accompanying fatal risks or dangers that, unless extremely high safety is secured, could have a serious effect to the public, and could lead directly to death, personal injury, severe physical damage or other loss (i.e., nuclear reaction control in nuclear facility, aircraft flight control, air traffic control, mass transport control, medical life support system, missile launch control in weapon system), or (2) for use requiring extremely high reliability (i.e., submersible repeater and artificial satellite).
Please note that FUJITSU MICROELECTRONICS will not be liable against you and/or any third party for any claims or damages arising in connection with above-mentioned uses of the products.
- Any semiconductor devices have an inherent chance of failure. You must protect against injury, damage or loss from such failures by incorporating safety design measures into your facility and equipment such as redundancy, fire protection, and prevention of over-current levels and other abnormal operating conditions.
- Exportation/release of any products described in this document may require necessary procedures in accordance with the regulations of the Foreign Exchange and Foreign Trade Control Law of Japan and/or US export control laws.
- The company names and brand names herein are the trademarks or registered trademarks of their respective owners.

1. Checking the Delivered Product

Before using the LQFP-64P header, confirm that the following components are included in the box:

• LQFP-64P header* ¹ :	1
• Screws for securing header board (M2 × 10mm, 0.4mm pitch):	4
• Washer:	4
• NQPACK064SB* ² :	1
• HQPACK064SB140* ³ :	1
• Operation manual (Japanese version):	1
• Operation manual (English version, this manual):	1

*1 : Referred to as “header board”. Header board is mounted on YQPACK064SB-4W (Tokyo Eletech Corporation) , referred to as “YQPACK”.

*2 : IC socket manufactured by Tokyo Eletech Corporation, referred to as “NQPACK”, and supplied with a screwdriver and 3 guide pins. A socket offering higher reliability, NQPACK064SB-SL (Tokyo Eletech Corporation, sold separately), can be used by making an IC socket mounting hole on the user system board. For more information, contact Tokyo Eletech Corporation.

*3 : IC Socket cover manufactured by Tokyo Eletech Corporation, referred to as “HQPACK”, with 4 screws for securing HQPACK (M2 × 6 mm, 0.4 mm pitch).

This product is used as an adapter unit by combining with an optional “DSU-FR EMULATOR PGA-401P ADAPTER TYPE 2 (MB2198-130-E)” (sold separately).

Please contact the sales or support representative for details on the adapter that can be used with this product.

2. Handling Precautions

The adapter unit is precision-manufactured to improve dimensional accuracy and to ensure reliable contact. The header is therefore sensitive to mechanical shock. To ensure correct use of the header in the proper environment, observe the following points regarding its insertion and removal:

- To avoid placing stress on the NQPACK mounted on the user system board during connecting the adapter unit.

3. Notes on Designing

■ Restrictions of PC board for the user system

Once the header board is connected to the user system, the heights of parts mounted in the space around the header board are restricted.

The PC board of the user system must be designed with due consideration given to this restriction (Figure 1).

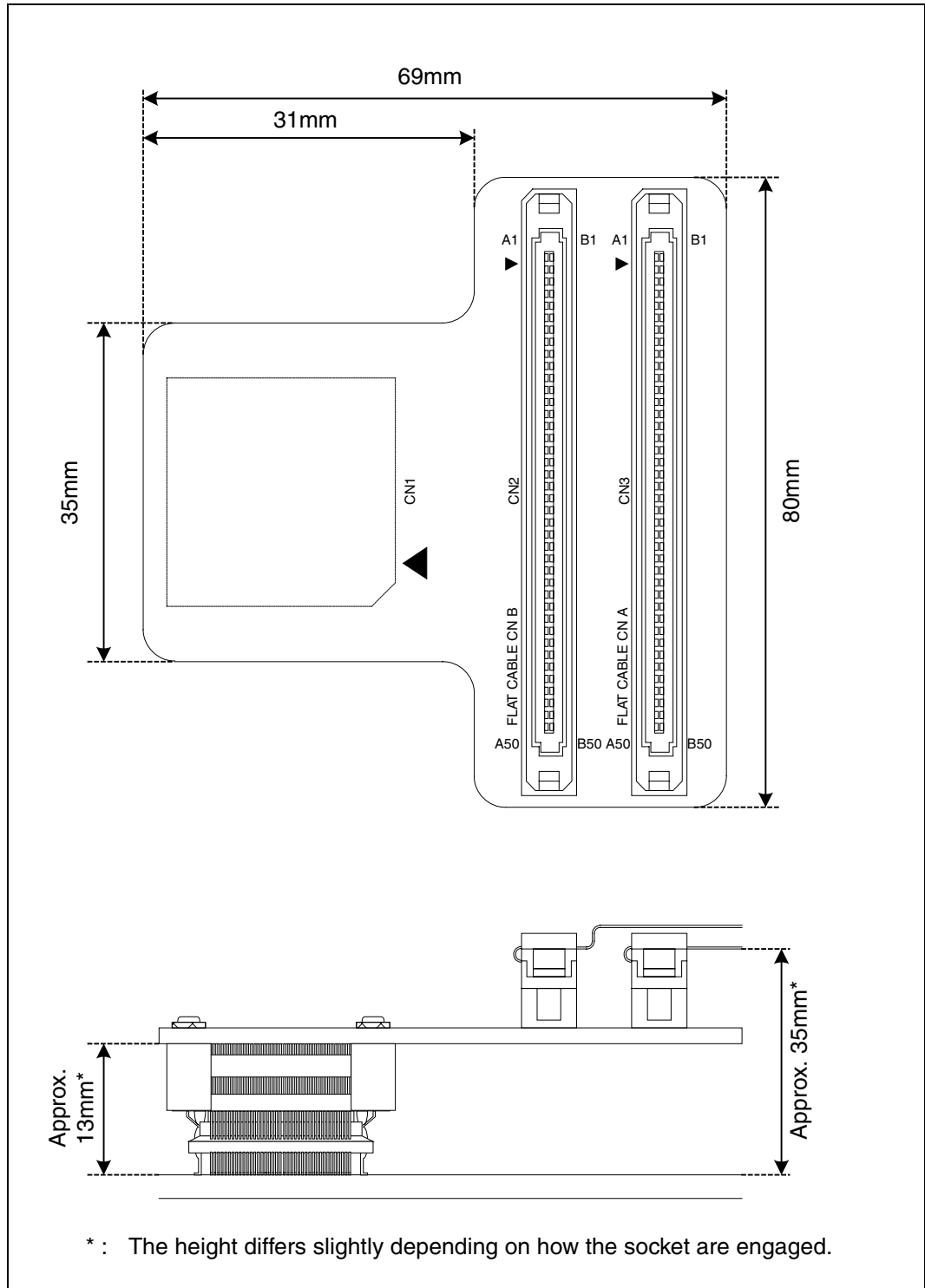

Figure 1 Header board dimensions

■ **MCU footprint design notes**

Figure 2 shows the recommended dimensions of the NQPACK footprint mounted on the PC board of the user system.

The PC board of the user system must be designed with due consideration given to this footprint as well as to the mass production MCU.

For more information, contact the Tokyo Eletech Corporation.

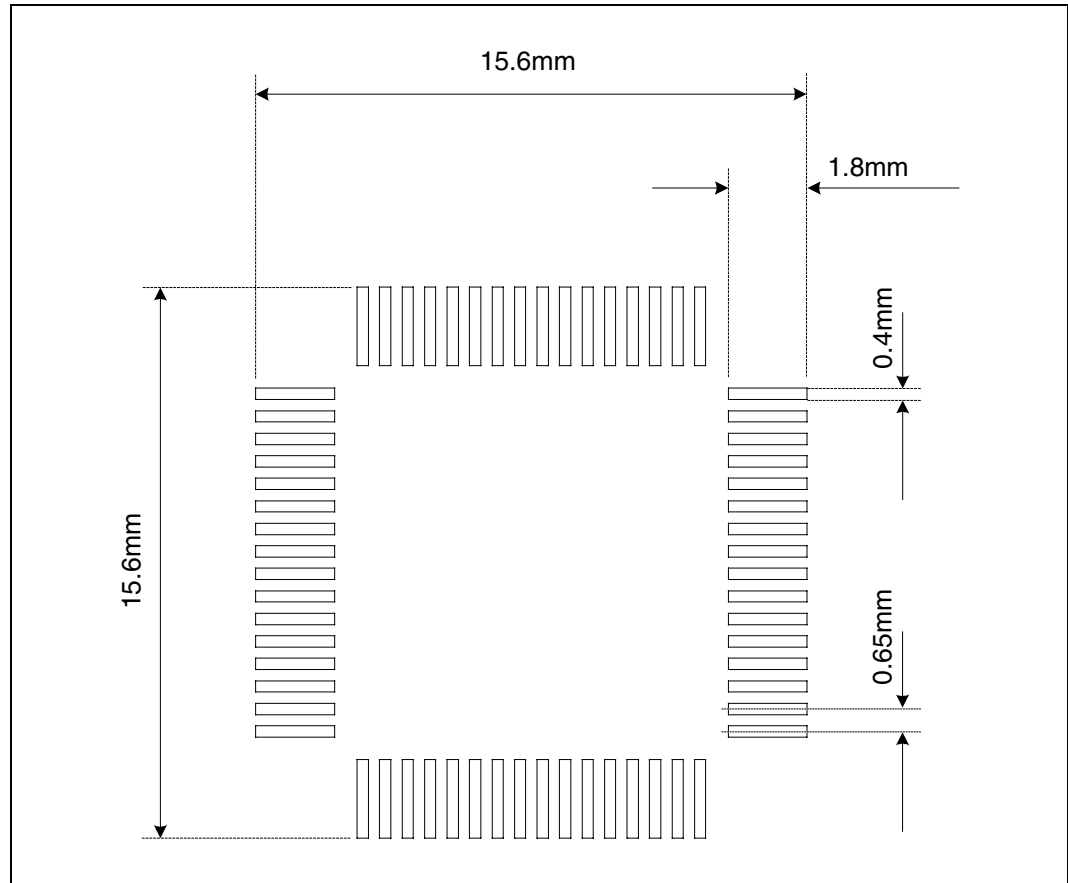

Figure 2 Recommended dimensions of the footprint for mounting the NQPACK

4. Procedure for Connecting the User System

Before using the LQFP-64P header, mount the supplied NQPACK on the user system. To connect the header board to the adapter unit, use the flat cable (2 lines) supplied by the adapter unit sold separately. Refer to the operation manuals of each adapter unit about the way to connect.

■ Connection

1. To connect the header board to the user system, match the index mark (▲) on the NQPACK mounted on the user system with the index mark (▲) on the header board and then insert it (see Figure 3).
The pin of YQPACK is thin and easy to bent. Insert NQPACK after confirm that the pin of YQPACK is not bent.
2. Insert each screw for securing header board in each of the four drilled holes on the header board through a washer, and then first tighten the screws in opposing corners followed by the two remaining screws (see Figure 4). To tighten the screws, use the screwdriver supplied with the NQPACK to finally tighten the four screws in sequence. Tightening the screws too tight might result in a defective contact.

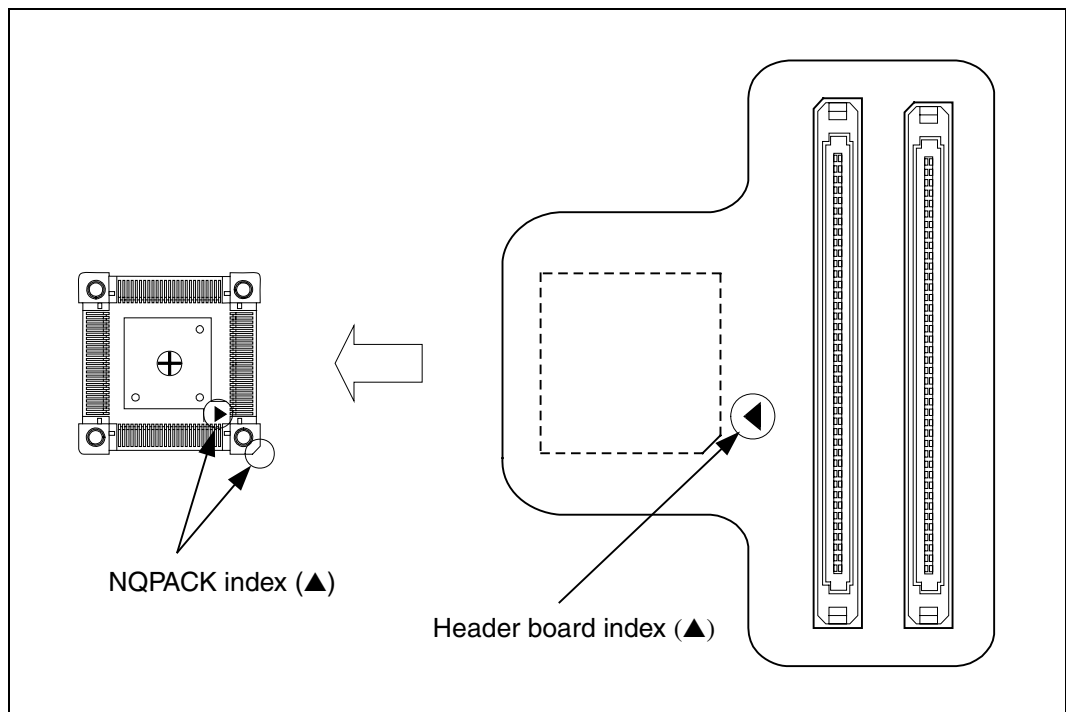

Figure 3 Index position

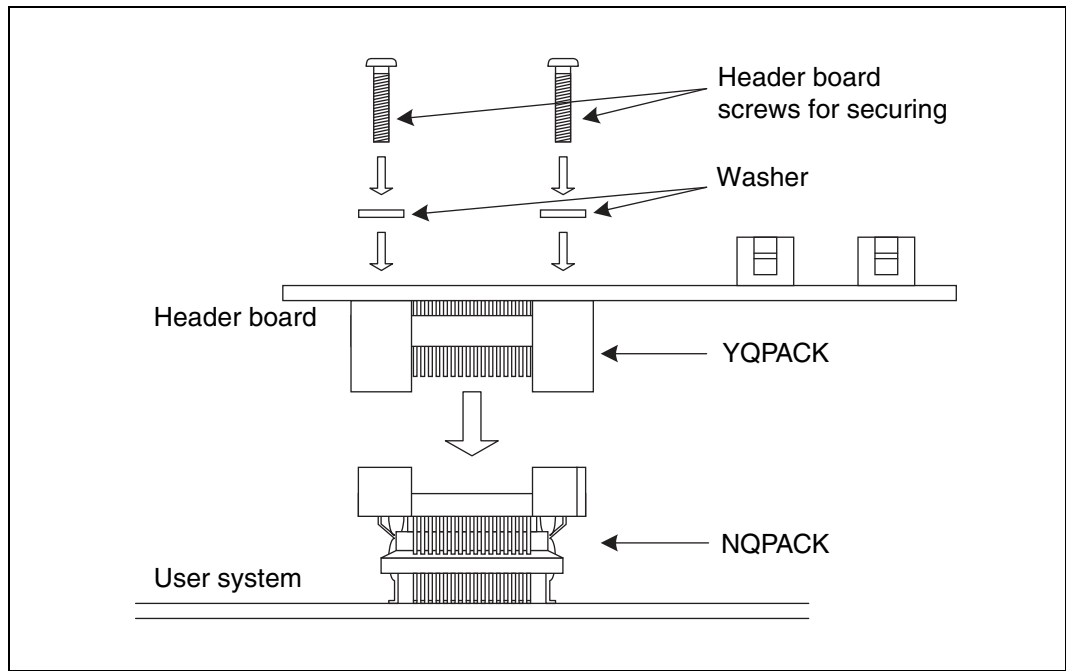

Figure 4 Header board connection

■ **Disconnection**

To disconnect the header board from the user system, remove all four screws, and then pull the header board straight out of the socket.

5. Mounting Mass Production MCUs

To mount a mass production MCU on the user system, use the supplied HQPACK (see Figure 5).

■ Mounting

1. To mount a mass production MCU on the user system, match the index mark (▲) on the NQPACK mounted on the user system with the index mark (●) on the mass production MCU.
2. Confirm that the mass production MCU is correctly mounted on the NQPACK. Next, insert the HQPACK into a NQPACK. The pin of HQPACK is thin and easy to bent. Insert NQPACK after confirm that the pin of HQPACK is not bent (see Figure 5).
3. Insert each screw for securing HQPACK in each of four drilled holes on the HQPACK, and then first tighten the screws in opposing corners followed by the two remaining screws. To tighten the screws, use the screwdriver supplied with the NQPACK to finally tighten the four screws in sequence. Tightening the screws too tight might result in a defective contact.

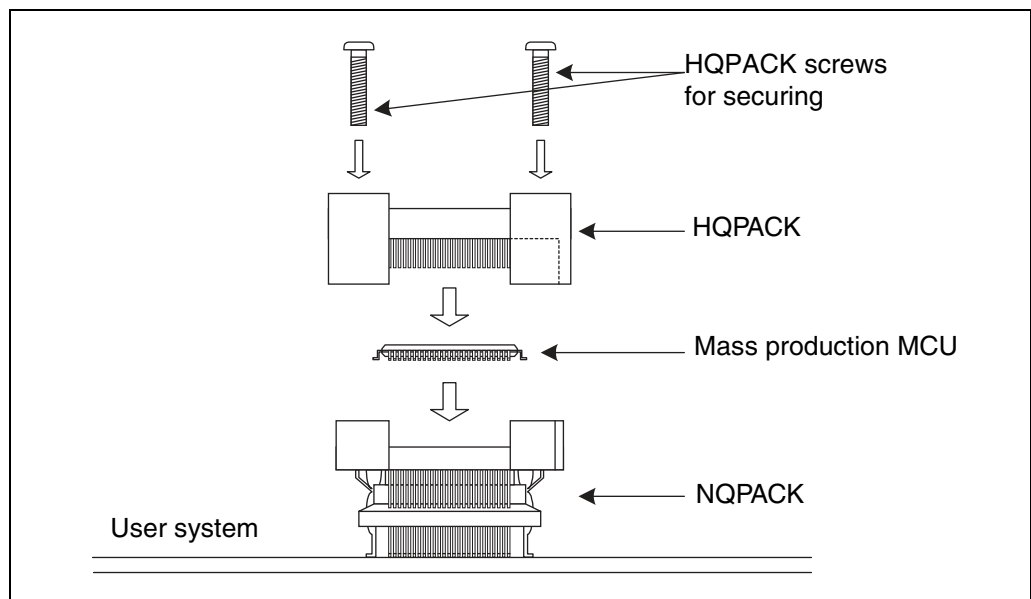

Figure 5 Mounting a mass production MCU

■ Disconnection

To remove the HQPACK, remove all four screws, and pull out the HQPACK vertically.

6. Pin Assignment of Connector

Signals from the evaluation MCU mounted on the adapter are connected to the header board according to mass production MCU's pin information (same pinouts as in the YQPACK) through (two) flat cable connectors on the header board.

For details on mass production MCU's pin information, refer to the data sheet or hardware manual for the MCU used.

■ Pin assignment

Tables 1 and 2 list the pinouts of the flat cable connectors and the corresponding pin numbers of the evaluation MCU and mass production MCU.

For details on the signal conductor names of the evaluation MCU, refer to the operation manual for the emulator or adapter.

Comments to the tables are given below:

- *1 : Connected to the evaluation MCU pins: VSS (pins 16 and 48).
- *2 : Connected to the mass production MCU pin: C (pin 15).
- *3 : Connected to the evaluation MCU pin: VCC (pin 17).
- *4 : Header board control pin (not connected to the mass production MCU)
- *5 : Connected to a land and routed so that the pin can be connected to the mass production MCU pin: C (pin 15) via a jumper wire.

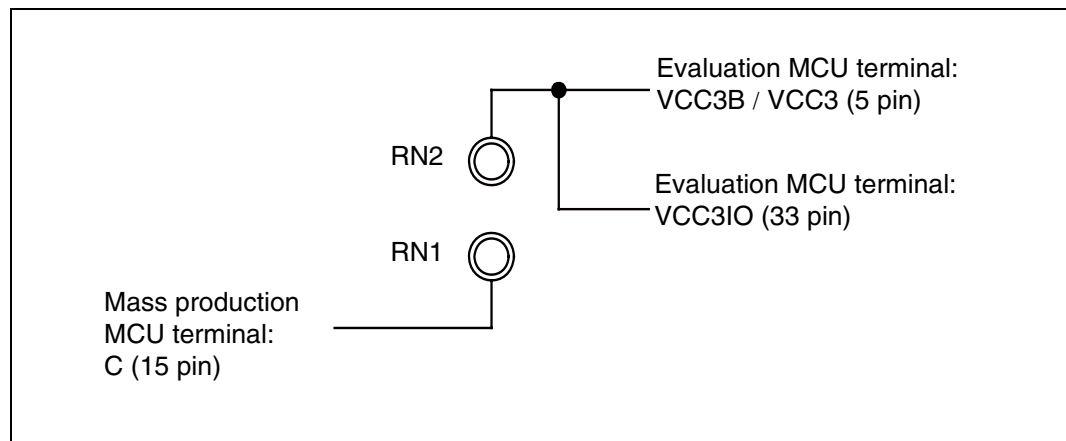

- *6 : Connected to VCC on the adapter.
 - *7 : The evaluation MCU pins: AVCC (pin 131) and AVRH (pin 296) are directly connected to the mass production MCU pin: AVCC (pin 64).
 - *8 : The evaluation MCU pins: P73 (pin 195) and P74 (pin 137) are used to select the package of the mass production MCU. Both of the pins are connected to VSS to select the LQFP-64P package.
- “ - ”: Unconnected (open) pin.

Table 1 Pin assignment of flat cable connector A

Connector pin numbers	Evaluation MCU pin numbers	Mass production MCU pin numbers	Connector pin numbers	Evaluation MCU pin numbers	Mass production MCU pin numbers
A1	VSS	*1	B1	VSS	*1
A2	135	-	B2	84	-
A3	301	-	B3	192	-
A4	191	-	B4	35	-
A5	349	-	B5	131	*7
A6	296	*7	B6	242	2
A7	186	1	B7	245	-
A8	188	-	B8	297	-
A9	244	-	B9	346	-
A10	187	-	B10	345	-
A11	243	-	B11	VSS	*1
A12	83	-	B12	300	-
A13	-	*2	B13	248	-
A14	249	-	B14	193	-
A15	VSS	*1	B15	85	-
A16	302	-	B16	36	-
A17	136	-	B17	303	-
A18	37	-	B18	86	-
A19	138	-	B19	VSS	*1
A20	250	-	B20	351	-
A21	195	*8	B21	137	*8
A22	38	-	B22	194	-
A23	VSS	*1	B23	-	*2
A24	5	*5	B24	87	49
A25	209	-	B25	51	-
A26	252	52	B26	251	50
A27	39	53	B27	VSS	*1
A28	40	55	B28	304	54
A29	139	57	B29	88	56
A30	41	-	B30	305	-
A31	VSS	*1	B31	89	-
A32	140	-	B32	196	-
A33	42	-	B33	253	-
A34	306	61	B34	-	*2
A35	197	60	B35	VSS	*1
A36	141	58	B36	90	59
A37	76	*6	B37	202	34
A38	310	35	B38	201	36
A39	VSS	*1	B39	357	37
A40	257	38	B40	144	39
A41	309	40	B41	256	41
A42	200	-	B42	356	-
A43	308	-	B43	VSS	*1
A44	92	-	B44	44	-
A45	255	-	B45	143	-
A46	199	-	B46	307	-
A47	91	42	B47	-	*2
A48	254	-	B48	142	-
A49	198	-	B49	43	-
A50	VSS	*1	B50	VSS	*1

Table 2 Pin assignment of flat cable connector B

Connector pin numbers	Evaluation MCU pin numbers	Mass production MCU pin numbers	Connector pin numbers	Evaluation MCU pin numbers	Mass production MCU pin numbers
A1	VSS	*1	B1	VSS	*1
A2	-	-	B2	50	-
A3	4	-	B3	315	-
A4	208	-	B4	98	-
A5	153	-	B5	182	14
A6	127	-	B6	239	-
A7	VSS	*1	B7	31	13
A8	293	12	B8	183	11
A9	78	-	B9	128	-
A10	184	-	B10	32	-
A11	240	10	B11	VSS	*1
A12	129	9	B12	79	8
A13	294	7	B13	185	63
A14	130	6	B14	241	5
A15	VSS	*1	B15	97	-
A16	80	4	B16	295	3
A17	-	*3	B17	344	62
A18	298	-	B18	132	-
A19	189	-	B19	VSS	*1
A20	246	-	B20	348	-
A21	299	-	B21	133	-
A22	81	-	B22	33	*5
A23	VSS	*1	B23	247	-
A24	190	-	B24	34	-
A25	134	-	B25	82	-
A26	-	*3	B26	29	46
A27	291	47	B27	VSS	*1
A28	258	33	B28	146	32
A29	203	31	B29	259	30
A30	93	29	B30	147	28
A31	VSS	*1	B31	204	27
A32	312	26	B32	260	25
A33	94	24	B33	45	23
A34	205	22	B34	148	21
A35	1	20	B35	VSS	*1
A36	-	*3	B36	95	19
A37	46	18	B37	126	51
A38	292	45	B38	30	44
A39	VSS	*1	B39	77	43
A40	206	-	B40	261	-
A41	47	-	B41	313	-
A42	2	-	B42	149	-
A43	150	-	B43	VSS	*1
A44	262	-	B44	48	-
A45	96	-	B45	151	-
A46	207	-	B46	49	-
A47	VSS	*1	B47	3	-
A48	263	-	B48	-	*3
A49	264	-	B49	-	-
A50	VSS	*1	B50	VSS	*1

SS01-71126-1E

FUJITSU MICROELECTRONICS • SUPPORT SYSTEM

DSU-FR EMULATOR
LQFP-64P HEADER
MB2198-128-E
OPERATION MANUAL

July 2008 the first edition

Published **FUJITSU MICROELECTRONICS LIMITED**

Edited Business & Media Promotion Dept.

FUJITSU