

Schottky Diode

$$V_{RRM} = 80 \text{ V}$$

$$I_{FAV} = 2 \times 35 \text{ A}$$

$$V_F = 0,64 \text{ V}$$

High Performance Schottky Diode
 Low Loss and Soft Recovery
 Common Cathode

Part number

DSSK70-008A

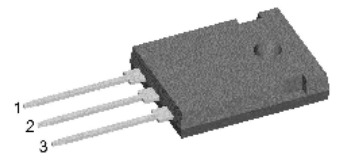

Backside: cathode

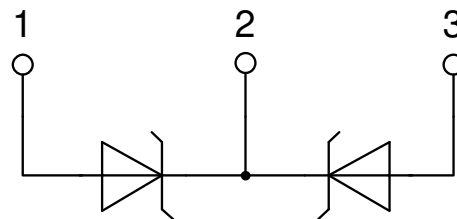

Features / Advantages:

- Very low V_f
- Extremely low switching losses
- Low I_{rm} values
- Improved thermal behaviour
- High reliability circuit operation
- Low voltage peaks for reduced protection circuits
- Low noise switching

Applications:

- Rectifiers in switch mode power supplies (SMPS)
- Free wheeling diode in low voltage converters

Package: TO-247

- Industry standard outline
- RoHS compliant
- Epoxy meets UL 94V-0

Disclaimer Notice

Information furnished is believed to be accurate and reliable. However, users should independently evaluate the suitability of and test each product selected for their own applications. Littelfuse products are not designed for, and may not be used in, all applications. Read complete Disclaimer Notice at www.littelfuse.com/disclaimer-electronics.



| Schottky | | | | Ratings | | | |
|------------|--|--|--------------------|------------------------------|------|------|------|
| Symbol | Definition | Conditions | | min. | typ. | max. | Unit |
| V_{RSM} | max. non-repetitive reverse blocking voltage | | | | | 80 | V |
| V_{RRM} | max. repetitive reverse blocking voltage | | | | | 80 | V |
| I_R | reverse current, drain current | $V_R = 80\text{ V}$ | | $T_{VJ} = 25^\circ\text{C}$ | | 2 | mA |
| | | $V_R = 80\text{ V}$ | | $T_{VJ} = 125^\circ\text{C}$ | | 10 | mA |
| V_F | forward voltage drop | $I_F = 35\text{ A}$ | | $T_{VJ} = 25^\circ\text{C}$ | | 0,76 | V |
| | | $I_F = 70\text{ A}$ | | | | 0,90 | V |
| | | $I_F = 35\text{ A}$ | | $T_{VJ} = 125^\circ\text{C}$ | | 0,64 | V |
| | | $I_F = 70\text{ A}$ | | | | 0,80 | V |
| I_{FAV} | average forward current | $T_C = 140^\circ\text{C}$ | rectangular | $T_{VJ} = 175^\circ\text{C}$ | | 35 | A |
| V_{F0} | threshold voltage | } for power loss calculation only | | $T_{VJ} = 175^\circ\text{C}$ | | 0,43 | V |
| r_F | slope resistance | | | | | 4,3 | mΩ |
| R_{thJC} | thermal resistance junction to case | | | | | 0,5 | K/W |
| R_{thCH} | thermal resistance case to heatsink | | | | 0,25 | | K/W |
| P_{tot} | total power dissipation | | | $T_C = 25^\circ\text{C}$ | | 300 | W |
| I_{FSM} | max. forward surge current | $t = 10\text{ ms}; (50\text{ Hz}), \text{ sine}; V_R = 0\text{ V}$ | | $T_{VJ} = 45^\circ\text{C}$ | | 700 | A |
| C_J | junction capacitance | $V_R = 12\text{ V}$ | $f = 1\text{ MHz}$ | $T_{VJ} = 25^\circ\text{C}$ | | 1,05 | nF |



| Package TO-247 | | | Ratings | | | |
|----------------|------------------------------|----------------------------|---------|------|------|------|
| Symbol | Definition | Conditions | min. | typ. | max. | Unit |
| I_{RMS} | RMS current | per terminal ¹⁾ | | | 70 | A |
| T_{VJ} | virtual junction temperature | | -55 | | 175 | °C |
| T_{op} | operation temperature | | -55 | | 150 | °C |
| T_{stg} | storage temperature | | -55 | | 150 | °C |
| Weight | | | | 6 | | g |
| M_D | mounting torque | | 0,8 | | 1,2 | Nm |
| F_C | mounting force with clip | | 20 | | 120 | N |

Product Marking

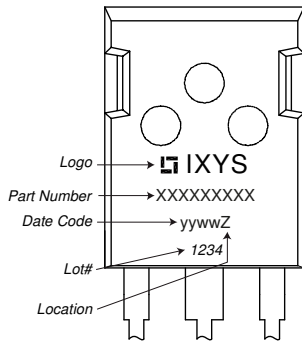

| Ordering | Ordering Number | Marking on Product | Delivery Mode | Quantity | Code No. |
|----------|-----------------|--------------------|---------------|----------|----------|
| Standard | DSSK70-008A | DSSK70-008A | Tube | 30 | 478776 |

| Similar Part | Package | Voltage class |
|--------------|----------------|---------------|
| DSSK70-008AR | ISOPLUS247 (3) | 80 |

Equivalent Circuits for Simulation

** on die level*

$T_{VJ} = 175^{\circ}C$

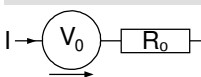

Schottky

| | | | |
|--------------|--------------------|------|----|
| $V_{0 \max}$ | threshold voltage | 0,43 | V |
| $R_{0 \max}$ | slope resistance * | 1,7 | mΩ |



Outlines TO-247

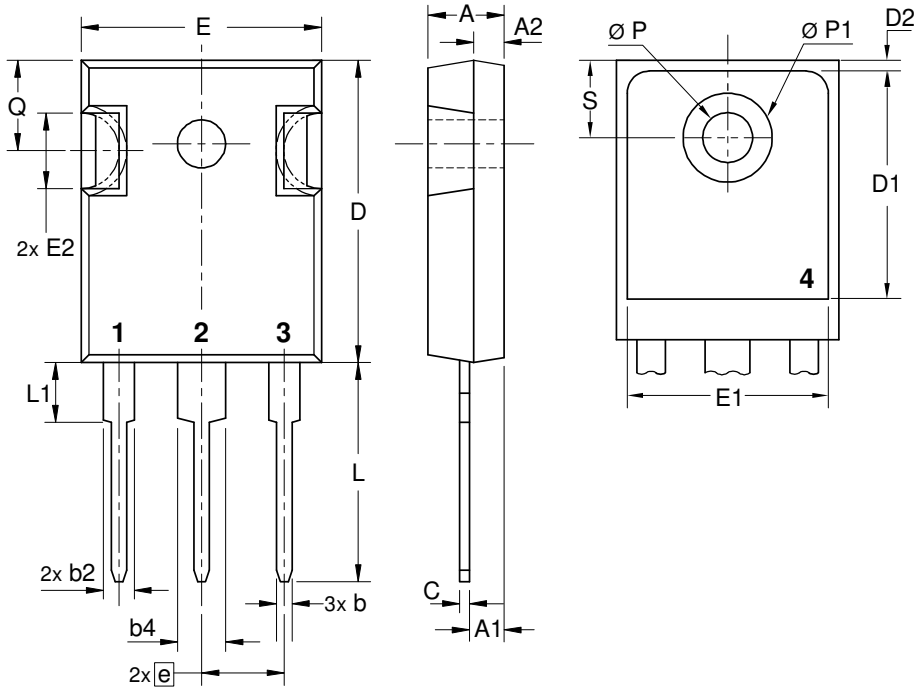

| Sym. | Inches | | Millimeter | |
|------|-----------|-------|------------|-------|
| | min. | max. | min. | max. |
| A | 0.185 | 0.209 | 4.70 | 5.30 |
| A1 | 0.087 | 0.102 | 2.21 | 2.59 |
| A2 | 0.059 | 0.098 | 1.50 | 2.49 |
| D | 0.819 | 0.845 | 20.79 | 21.45 |
| E | 0.610 | 0.640 | 15.48 | 16.24 |
| E2 | 0.170 | 0.216 | 4.31 | 5.48 |
| e | 0.215 BSC | | 5.46 BSC | |
| L | 0.780 | 0.800 | 19.80 | 20.30 |
| L1 | - | 0.177 | - | 4.49 |
| Ø P | 0.140 | 0.144 | 3.55 | 3.65 |
| Q | 0.212 | | 5.38 | |
| S | 0.242 BSC | | 6.14 BSC | |
| b | 0.039 | 0.055 | 0.99 | 1.40 |
| b2 | 0.065 | 0.094 | 1.65 | 2.39 |
| b4 | 0.102 | 0.135 | 2.59 | 3.43 |
| c | 0.015 | 0.035 | 0.38 | 0.89 |
| D1 | 0.515 | - | 13.07 | - |
| D2 | 0.020 | 0.053 | 0.51 | 1.35 |
| E1 | 0.530 | - | 13.45 | - |
| Ø P1 | - | 0.29 | - | 7.39 |

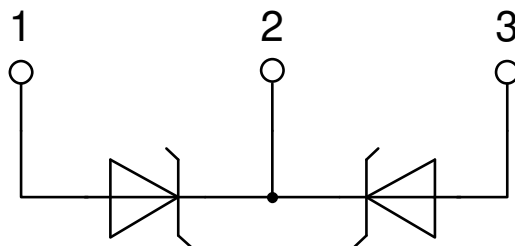

Schottky

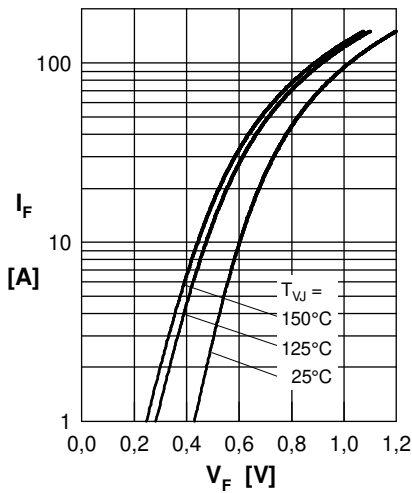

Fig. 1 Max. forward voltage drop characteristics

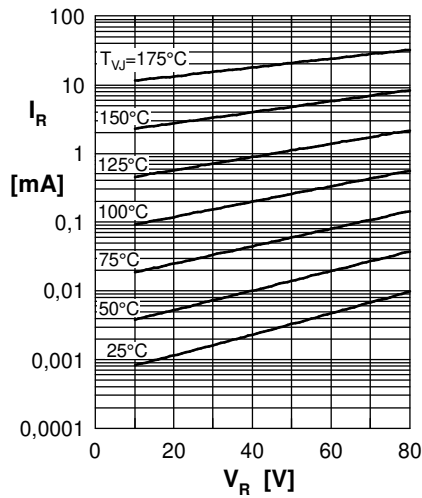

Fig. 2 Typ. reverse current I_R vs. reverse voltage V_R

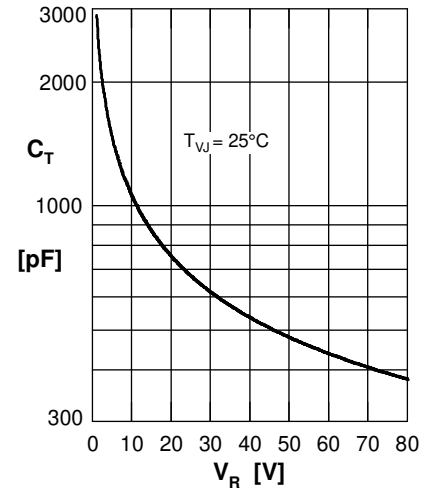

Fig. 3 Typ. junction capacitance C_T vs. reverse voltage V_R

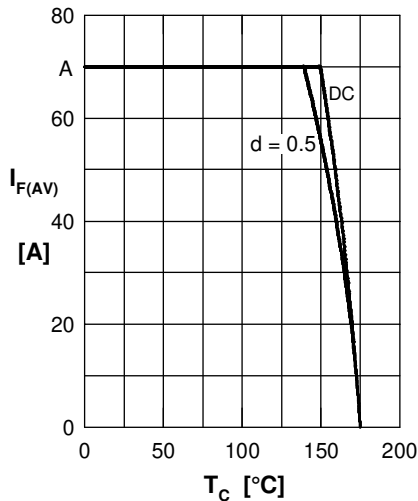

Fig. 4 Average forward current $I_{F(AV)}$ vs. case temp. T_C

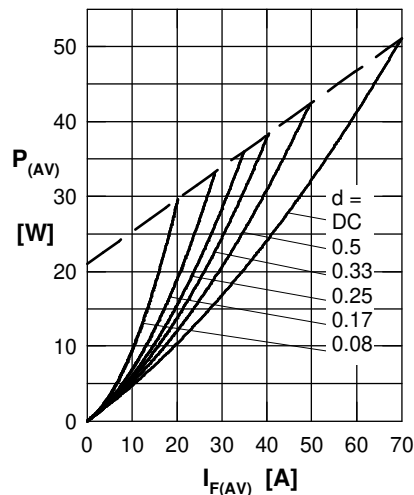

Fig. 5 Forward power loss characteristics

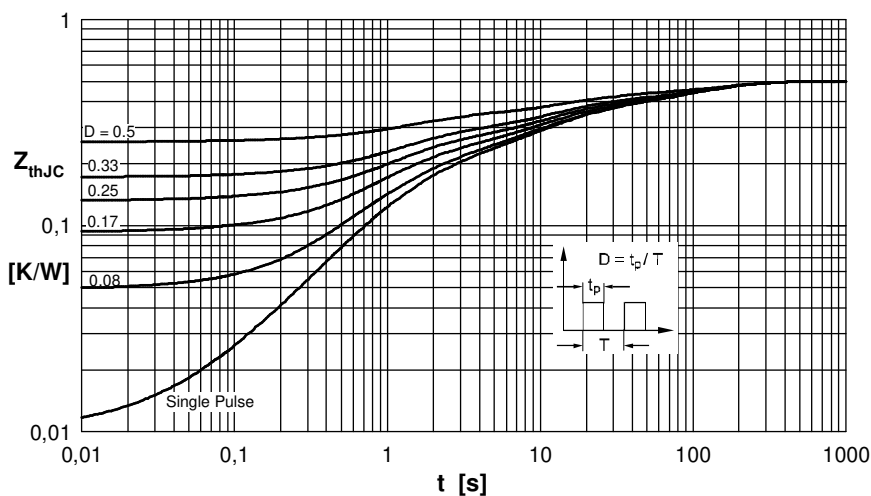

Fig. 6 Transient thermal impedance junction to case at various duty cycles

Note: All curves are per diode