



CC2538 Powerful Wireless Microcontroller System-On-Chip for 2.4-GHz IEEE 802.15.4, 6LoWPAN, and ZigBee® Applications

1 Device Overview

1.1 Features

- Microcontroller
 - Powerful ARM® Cortex®-M3 With Code Prefetch
 - Up to 32-MHz Clock Speed
 - 512KB, 256KB or 128KB of In-System-Programmable Flash
 - Supports On-Chip Over-the-Air Upgrade (OTA)
 - Supports Dual ZigBee Application Profiles
 - Up to 32KB of RAM (16KB With Retention in All Power Modes)
 - cJTAG and JTAG Debugging
- RF
 - 2.4-GHz IEEE 802.15.4 Compliant RF Transceiver
 - Excellent Receiver Sensitivity of –97 dBm
 - Robustness to Interference With ACR of 44 dB
 - Programmable Output Power up to 7 dBm
- Security Hardware Acceleration
 - Future Proof AES-128/256, SHA2 Hardware Encryption Engine
 - Optional – ECC-128/256, RSA Hardware Acceleration Engine for Secure Key Exchange
 - Radio Command Strobe Processor and Packet Handling Processor for Low-Level MAC Functionality
- Low Power
 - Active-Mode RX (CPU Idle): 20 mA
 - Active-Mode TX at 0 dBm (CPU Idle): 24 mA
 - Power Mode 1 (4- μ s Wake-Up, 32-KB RAM Retention, Full Register Retention): 0.6 mA
 - Power Mode 2 (Sleep Timer Running, 16-KB RAM Retention, Configuration Register Retention): 1.3 μ A
 - Power Mode 3 (External Interrupts, 16-KB RAM Retention, Configuration Register Retention): 0.4 μ A
 - Wide Supply-Voltage Range (2 V to 3.6 V)
- Peripherals
 - μ DMA
 - 4 \times General-Purpose Timers (Each 32-Bit or 2 \times 16-Bit)
 - 32-Bit 32-kHz Sleep Timer
 - 12-Bit ADC With 8 Channels and Configurable Resolution
 - Battery Monitor and Temperature Sensor
 - USB 2.0 Full-Speed Device (12 Mbps)
 - 2 \times SPI
 - 2 \times UART
 - I2C
 - 32 General-Purpose I/O Pins (28 \times 4 mA, 4 \times 20 mA)
 - Watchdog Timer
- Layout
 - 8-mm \times 8-mm QFN56 Package
 - Robust Device for Industrial Operation up to 125°C
 - Few External Components
 - Only a Single Crystal Needed for Asynchronous Networks
- Development Tools
 - CC2538 Development Kit
 - Reference Design Certified Under FCC and ETSI Regulations
 - Full Software Support for Contiki/6LoWPAN, Smart Grid, Lighting, and ZigBee Home Automation With Sample Applications and Reference Designs Available
 - Code Composer Studio™
 - IAR Embedded Workbench® for ARM
 - SmartRF™ Studio
 - SmartRF Flash Programmer

1.2 Applications

- Smart Grid and Home Area Network
- Home and Building Automation
- Intelligent Lighting Systems
- Wireless Sensor Networks
- Internet of Things



1.3 Description

The CC2538xFnn is the ideal wireless microcontroller System-on-Chip (SoC) for high-performance ZigBee applications. The device combines a powerful ARM Cortex-M3-based MCU system with up to 32KB on-chip RAM and up to 512KB on-chip flash with a robust IEEE 802.15.4 radio. This enables the device to handle complex network stacks with security, demanding applications, and over-the-air download. Thirty-two GPIOs and serial peripherals enable simple connections to the rest of the board. The powerful hardware security accelerators enable quick and efficient authentication and encryption while leaving the CPU free to handle application tasks. The multiple low-power modes with retention enable quick startup from sleep and minimum energy spent to perform periodic tasks. For a smooth development, the CC2538xFnn includes a powerful debugging system and a comprehensive driver library. To reduce the application flash footprint, CC2538xFnn ROM includes a utility function library and a serial boot loader. Combined with the robust and comprehensive Z-Stack software solutions from TI, the CC2538 provides the most capable and proven ZigBee solution in the market.

Device Information⁽¹⁾

PART NUMBER	PACKAGE	BODY SIZE
CC2538RTQ	RTQ (56)	8.00 mm × 8.00 mm

(1) For more information, see [Section 8](#), *Mechanical Packaging and Orderable Information*.

1.4 Functional Block Diagram

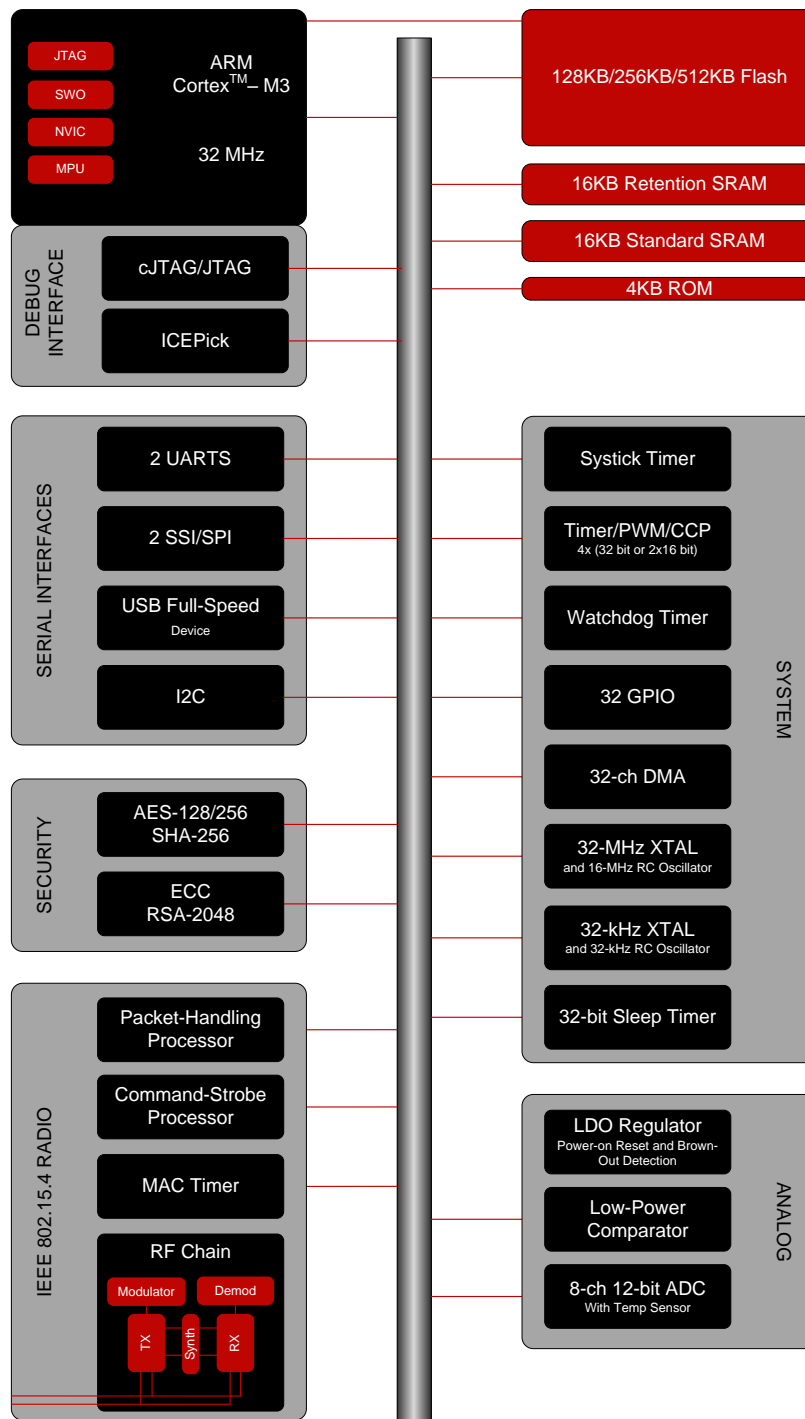

Figure 1-1. CC2538 Block Diagram

Table of Contents

1	Device Overview	1	5.15	Analog Temperature Sensor	15
1.1	Features	1	5.16	ADC Characteristics	16
1.2	Applications	1	5.17	Control Input AC Characteristics	17
1.3	Description	2	5.18	DC Characteristics	17
1.4	Functional Block Diagram	3	5.19	USB Interface DC Characteristics	17
2	Revision History	5	5.20	Thermal Resistance Characteristics for RTQ Package	18
3	Device Comparison	6	6	Applications, Implementation, and Layout	19
4	Terminal Configuration and Functions	7	6.1	Input, Output Matching	20
4.1	Signal Descriptions	7	6.2	Crystal	20
5	Specifications	9	6.3	On-Chip 1.8-V Voltage-Regulator Decoupling	21
5.1	Absolute Maximum Ratings	9	6.4	Power-Supply Decoupling and Filtering	21
5.2	ESD Ratings	9	6.5	References	21
5.3	Recommended Operating Conditions	9	7	Device and Documentation Support	22
5.4	Electrical Characteristics	10	7.1	Device Support	22
5.5	General Characteristics	11	7.2	Documentation Support	23
5.6	RF Receive Section	12	7.3	Additional Information	23
5.7	RF Transmit Section	13	7.4	Trademarks	24
5.8	32-MHz Crystal Oscillator	14	7.5	Electrostatic Discharge Caution	24
5.9	32.768-kHz Crystal Oscillator	14	7.6	Export Control Notice	24
5.10	32-kHz RC Oscillator	14	7.7	Glossary	24
5.11	16-MHz RC Oscillator	15	8	Mechanical Packaging and Orderable Information	25
5.12	RSSI/CCA Characteristics	15	8.1	Packaging Information	25
5.13	FREQEST Characteristics	15			
5.14	Frequency Synthesizer Characteristics	15			

2 Revision History

Changes from Revision C (February 2015) to Revision D Page

- Changed Figure 6-1 *CC2538xFnn Application Circuit* [19](#)

Changes from Revision B (September 2014) to Revision C Page

- Changed ZigBee Smart Energy 1.x and ZigBee Light Link to Smart Grid and Lighting..... [1](#)
- Added 8-ch to the 12-bit ADC..... [3](#)
- Added ESD Ratings table. [9](#)

3 Device Comparison

Table 3-1. CC2538 Family of Devices Available

DEVICE	FLASH (KB)	RAM (KB)	SECURITY HW AES/SHA	SECURITY HW ECC/RSA
CC2538SF53	512	32	Yes	Yes
CC2538SF23	256	32	Yes	Yes
CC2538NF53	512	32	Yes	No
CC2538NF23	256	32	Yes	No
CC2538NF11	128	16	Yes	No

4 Terminal Configuration and Functions

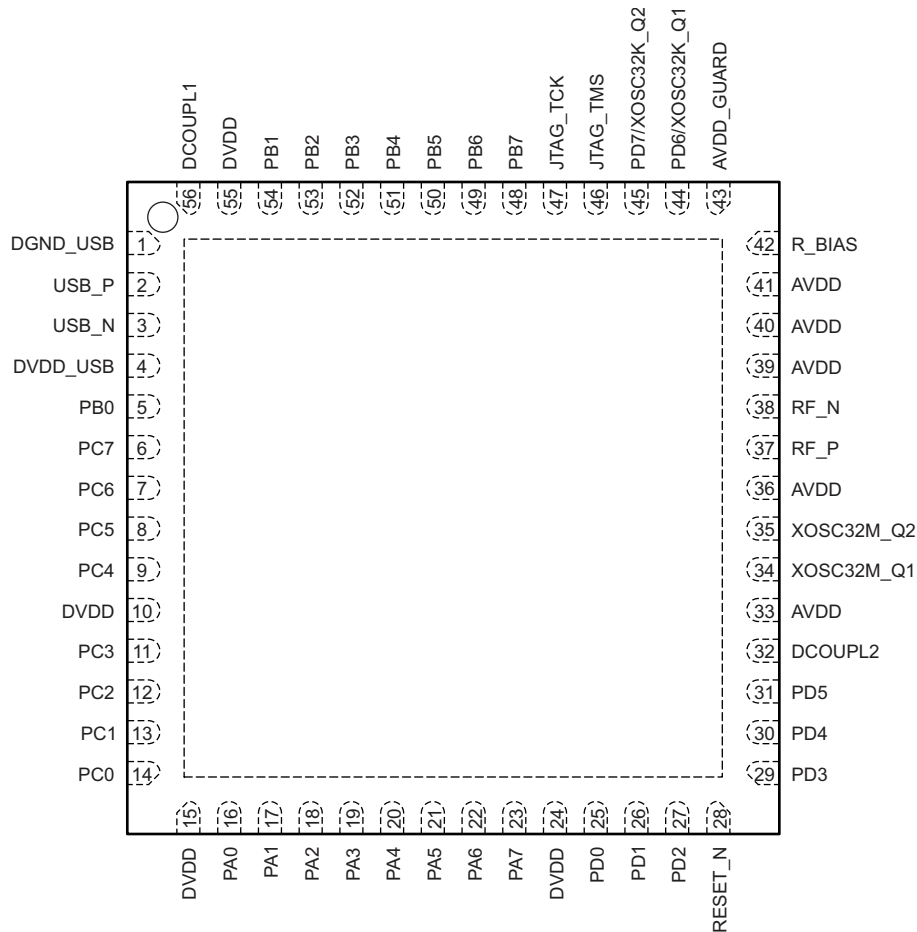

P0142-01

Connect the exposed ground pad to a solid ground plane, as this is the ground connection for the chip.

Figure 4-1. 56-Pin RTQ Package (Top View)

4.1 Signal Descriptions

Table 4-1. Signal Descriptions

NAME	NUMBER	PIN TYPE	DESCRIPTION
AVDD	33, 36, 39, 40, 41	Power (analog)	2-V–3.6-V analog power-supply connection
AVDD_GUARD	43	Power (analog)	2-V–3.6-V analog power-supply connection
DCOUP1	56	Power (digital)	1.8-V regulated digital-supply decoupling capacitor
DCOUP2	32	Power (digital)	1.8-V regulated digital-supply decoupling capacitor. Short this pin to pin 56.
DGND_USB	1	Ground (USB pads)	USB ground
DVDD	10, 15, 24, 55	Power (digital)	2-V–3.6-V digital power-supply connection
DVDD_USB	4	Power (USB pads)	3.3-V USB power-supply connection
JTAG_TCK	47	Digital I/O	JTAG TCK
JTAG_TMS	46	Digital I/O	JTAG TMS
PA0	16	Digital/analog I/O	GPIO port A pin 0. ROM bootloader UART RXD
PA1	17	Digital/analog I/O	GPIO port A pin 1. ROM bootloader UART TXD
PA2	18	Digital/analog I/O	GPIO port A pin 2. ROM bootloader SSI CLK

Table 4-1. Signal Descriptions (continued)

NAME	NUMBER	PIN TYPE	DESCRIPTION
PA3	19	Digital/analog I/O	GPIO port A pin 3. ROM bootloader SSI SEL
PA4	20	Digital/analog I/O	GPIO port A pin 4. ROM bootloader SSI RXD
PA5	21	Digital/analog I/O	GPIO port A pin 5. ROM bootloader SSI TXD
PA6	22	Digital/analog I/O	GPIO port A pin 6
PA7	23	Digital/analog I/O	GPIO port A pin 7
PB0	5	Digital I/O	GPIO port B pin 0
PB1	54	Digital I/O	GPIO port B pin 1
PB2	53	Digital I/O	GPIO port B pin 2
PB3	52	Digital I/O	GPIO port B pin 3
PB4	51	Digital I/O	GPIO port B pin 4
PB5	50	Digital I/O	GPIO port B pin 5
PB6	49	Digital I/O	GPIO port B pin 6, TDI (JTAG)
PB7	48	Digital I/O	GPIO port B pin 7, TDO (JTAG)
PC0	14	Digital I/O	GPIO port C pin 0, 20 mA output capability, no pull-up or pull-down
PC1	13	Digital I/O	GPIO port C pin 1, 20 mA output capability, no pull-up or pull-down
PC2	12	Digital I/O	GPIO port C pin 2, 20 mA output capability, no pull-up or pull-down
PC3	11	Digital I/O	GPIO port C pin 3, 20 mA output capability, no pull-up or pull-down
PC4	9	Digital I/O	GPIO port C pin 4
PC5	8	Digital I/O	GPIO port C pin 5
PC6	7	Digital I/O	GPIO port C pin 6
PC7	6	Digital I/O	GPIO port C pin 7
PD0	25	Digital I/O	GPIO port D pin 0
PD1	26	Digital I/O	GPIO port D pin 1
PD2	27	Digital I/O	GPIO port D pin 2
PD3	29	Digital I/O	GPIO port D pin 3
PD4	30	Digital I/O	GPIO port D pin 4
PD5	31	Digital I/O	GPIO port D pin 5
PD6/XOSC32K_Q1	44	Digital/analog I/O	GPIO port D pin 6 / 32-kHz crystal oscillator pin 1
PD7/XOSC32K_Q2	45	Digital/analog I/O	GPIO port D pin 7 / 32-kHz crystal oscillator pin 1
R_BIAS	42	Analog I/O	External precision bias resistor for reference current
RESET_N	28	Digital input	Reset, active-low
RF_N	38	RF I/O	Negative RF input signal to LNA during RX Negative RF output signal from PA during TX
RF_P	37	RF I/O	Positive RF input signal to LNA during RX Positive RF output signal from PA during TX
USB_P	2	USB I/O	USB differential data plus (D+)
USB_N	3	USB I/O	USB differential data minus (D-)
XOSC32M_Q1	34	Analog I/O	32-MHz crystal oscillator pin 1 or external-clock input
XOSC32M_Q2	35	Analog I/O	32-MHz crystal oscillator pin 2

5 Specifications

5.1 Absolute Maximum Ratings⁽¹⁾⁽²⁾⁽³⁾

over operating free-air temperature range (unless otherwise noted)

		MIN	MAX	UNIT
Supply voltage	All supply pins must have the same voltage	-0.3	3.9	V
Voltage on any digital pin		-0.3	$V_{DD} + 0.3, \leq 3.9$	V
Input RF level			10	dBm
T_{stg}	Storage temperature range	-40	125	°C

- (1) Stresses beyond those listed under absolute maximum ratings may cause permanent damage to the device. These are stress ratings only, and functional operation of the device at these or any other conditions beyond those indicated under recommended operating conditions is not implied. Exposure to absolute-maximum-rated conditions for extended periods may affect device reliability.
- (2) All voltage values are with respect to V_{SS} , unless otherwise noted.
- (3) Stresses beyond those listed under *Absolute Maximum Ratings* may cause permanent damage to the device. These are stress ratings only, and functional operation of the device at these or any other conditions beyond those indicated under *Recommended Operating Conditions* is not implied. Exposure to absolute-maximum-rated conditions for extended periods may affect device reliability.

5.2 ESD Ratings

			VALUE	UNIT
V_{ESD}	Electrostatic discharge (ESD) performance:	Human body model (HBM), per ANSI/ESDA/JEDEC JS001 ⁽¹⁾	±1	kV
		Charged device model (CDM), per JESD22-C101 ⁽²⁾	±500	V

- (1) JEDEC document JEP155 states that 500-V HBM allows safe manufacturing with a standard ESD control process.
- (2) JEDEC document JEP157 states that 250-V CDM allows safe manufacturing with a standard ESD control process.

5.3 Recommended Operating Conditions

over operating free-air temperature range (unless otherwise noted)

	MIN	MAX	UNIT
Operating ambient temperature range, T_A	-40	125	°C
Operating supply voltage ⁽¹⁾	2	3.6	V

- (1) The CC2538 contains a power on reset (POR) module and a brown out detector (BOD) that prevent the device from operating under unsafe supply voltage conditions. In the two lowest power modes, PM2 and PM3, the POR is active but the BOD is powered down, which gives a limited voltage supervision.
If the supply voltage is lowered to below 1.4 V during PM2/PM3, at temperatures of 70°C or higher, and then brought back up to good operating voltage before active mode is re-entered, registers and RAM contents that are saved in PM2, PM3 may become altered. Hence, care should be taken in the design of the system power supply to ensure that this does not occur. The voltage can be periodically supervised accurately by entering active mode, as a BOD reset is triggered if the supply voltage is below approximately 1.7 V.

5.4 Electrical Characteristics

Measured on TI's CC2538 EM reference design with $T_A = 25^\circ\text{C}$, $V_{DD} = 3\text{ V}$, and 8-MHz system clock, unless otherwise noted. **Boldface** limits apply over the entire operating range, $T_A = -40^\circ\text{C}$ to 125°C , $V_{DD} = 2\text{ V}$ to 3.6 V , and $f_c = 2394\text{ MHz}$ to 2507 MHz .

PARAMETER		TEST CONDITIONS	MIN	TYP	MAX	UNIT	
I_{core}	Core current consumption	Digital regulator on. 16-MHz RCOSC running. No radio, crystals, or peripherals active. CPU running at 16-MHz with flash access		7		mA	
		32-MHz XOSC running. No radio or peripherals active. CPU running at 32-MHz with flash access.		13		mA	
		32-MHz XOSC running, radio in RX mode, -50-dBm input power, no peripherals active, CPU idle		20		mA	
		32-MHz XOSC running, radio in RX mode at -100-dBm input power (waiting for signal), no peripherals active, CPU idle		24	27	mA	
		32-MHz XOSC running, radio in TX mode, 0-dBm output power, no peripherals active, CPU idle		24		mA	
		32-MHz XOSC running, radio in TX mode, 7-dBm output power, no peripherals active, CPU idle		34		mA	
		Power mode 1. Digital regulator on; 16-MHz RCOSC and 32-MHz crystal oscillator off; 32.768-kHz XOSC, POR, BOD and sleep timer active; RAM and register retention		0.6		mA	
		Power mode 2. Digital regulator off; 16-MHz RCOSC and 32-MHz crystal oscillator off; 32.768-kHz XOSC, POR, and sleep timer active; RAM and register retention		1.3	2	μA	
		Power mode 3. Digital regulator off; no clocks; POR active; RAM and register retention		0.4	1	μA	
I_{peri}	Peripheral Current Consumption (Adds to core current I_{core} for each peripheral unit activated)						
	General-purpose timer	Timer running, 32-MHz XOSC used		120		μA	
	SPI			300		μA	
	I2C			0.1		mA	
	UART			0.7		mA	
	Sleep timer	Including 32.753-kHz RCOSC		0.9		μA	
	USB	48-MHz clock running, USB enabled		3.8		mA	
	ADC	When converting		1.2		mA	
	Flash	Erase			12		mA
		Burst-write peak current			8		mA

5.5 General Characteristics

Measured on TI's CC2538 EM reference design with $T_A = 25\text{ }^\circ\text{C}$ and $V_{DD} = 3\text{ V}$, unless otherwise noted.

PARAMETER	TEST CONDITIONS	MIN	TYP	MAX	UNIT
Wake-Up and Timing					
Power mode 1 → active	Digital regulator on, 16-MHz RCOSC and 32-MHz crystal oscillator off. Start-up of 16-MHz RCOSC		4		μs
Power mode 2 or 3 → active	Digital regulator off, 16-MHz RCOSC and 32-MHz crystal oscillator off. Start-up of regulator and 16-MHz RCOSC		136		μs
Active → TX or RX	Initially running on 16-MHz RCOSC, with 32-MHz XOSC off		0.5		ms
	With 32-MHz XOSC initially on			192	μs
RX/TX and TX/RX turnaround				192	μs
USB PLL start-up time	With 32-MHz XOSC initially on		32		μs
Radio Part					
RF frequency range	Programmable in 1-MHz steps, 5 MHz between channels for compliance with ⁽¹⁾	2394		2507	MHz
Radio baud rate	As defined by ⁽¹⁾		250		kbps
Radio chip rate	As defined by ⁽¹⁾		2		MChip/s
Flash Memory					
Flash erase cycles				20	k Cycles
Flash page size			2		KB

- (1) IEEE Std. 802.15.4-2006: Wireless Medium Access Control (MAC) and Physical Layer (PHY) Specifications for Low-Rate Wireless Personal Area Networks (LR-WPANs)
<http://standards.ieee.org/getieee802/download/802.15.4-2006.pdf>

5.6 RF Receive Section

Measured on TI's CC2538 EM reference design with $T_A = 25^\circ\text{C}$, $V_{DD} = 3\text{ V}$, and $f_c = 2440\text{ MHz}$, unless otherwise noted.

Bold limits apply over the entire operating range, $T_A = -40^\circ\text{C}$ to 125°C , $V_{DD} = 2\text{ V}$ to 3.6 V , and $f_c = 2394\text{ MHz}$ to 2507 MHz .

PARAMETER	TEST CONDITIONS	MIN	TYP	MAX	UNIT
Receiver sensitivity	PER = 1%, as specified by ⁽¹⁾ , normal operating conditions (25 °C, 3 V, 2440 MHz) ⁽¹⁾ requires –85 dBm		–97	–92	dBm
	PER = 1%, as specified by ⁽¹⁾ , entire operating conditions ⁽¹⁾ requires –85 dBm			–88	dBm
Saturation (maximum input level)	PER = 1%, as specified by ⁽¹⁾ ⁽¹⁾ requires –20 dBm		10		dBm
Adjacent-channel rejection, 5-MHz channel spacing	Wanted signal –82 dBm, adjacent modulated channel at 5 MHz, PER = 1%, as specified by ⁽¹⁾ . ⁽¹⁾ requires 0 dB		44		dB
Adjacent-channel rejection, –5-MHz channel spacing	Wanted signal –82 dBm, adjacent modulated channel at –5 MHz, PER = 1%, as specified by ⁽¹⁾ . ⁽¹⁾ requires 0 dB		44		dB
Alternate-channel rejection, 10-MHz channel spacing	Wanted signal –82 dBm, adjacent modulated channel at 10 MHz, PER = 1%, as specified by ⁽¹⁾ ⁽¹⁾ requires 30 dB		52		dB
Alternate-channel rejection, –10-MHz channel spacing	Wanted signal –82 dBm, adjacent modulated channel at –10 MHz, PER = 1%, as specified by ⁽¹⁾ ⁽¹⁾ requires 30 dB		52		dB
Channel rejection ≥ 20 MHz ≤ –20 MHz	Wanted signal at –82 dBm. Undesired signal is an IEEE 802.15.4 modulated channel, stepped through all channels from 2405 to 2480 MHz. Signal level for PER = 1%.		51 51		dB
Blocking/desensitization 5 MHz from band edge 10 MHz from band edge 20 MHz from band edge 50 MHz from band edge –5 MHz from band edge –10 MHz from band edge –20 MHz from band edge –50 MHz from band edge	Wanted signal 3 dB above the sensitivity level, CW jammer, PER = 1%. Measured according to EN 300 440 class 2.		–35 –34 –37 –32 –37 –38 –35 –34		dBm
Spurious emission. Only largest spurious emission stated within each band. 30 MHz–1000 MHz 1 GHz–12.75 GHz	Conducted measurement with a 50-Ω single-ended load. Suitable for systems targeting compliance with EN 300 328, EN 300 440, FCC CFR47 Part 15, and ARIB STD-T-66.		–80 –80		dBm
Frequency error tolerance ⁽²⁾	⁽¹⁾ requires minimum 80 ppm		±150		ppm
Symbol rate error tolerance ⁽³⁾	⁽¹⁾ requires minimum 80 ppm		±1000		ppm

(1) IEEE Std. 802.15.4-2006: Wireless Medium Access Control (MAC) and Physical Layer (PHY) Specifications for Low-Rate Wireless Personal Area Networks (LR-WPANs)

<http://standards.ieee.org/getieee802/download/802.15.4-2006.pdf>

(2) Difference between center frequency of the received RF signal and local oscillator frequency

(3) Difference between incoming symbol rate and the internally generated symbol rate

5.7 RF Transmit Section

Measured on TI's CC2538 EM reference design with $T_A = 25^\circ\text{C}$, $V_{DD} = 3\text{ V}$ and $f_c = 2440\text{ MHz}$, unless otherwise noted.

Boldface limits apply over the entire operating range, $T_A = -40^\circ\text{C}$ to 125°C , $V_{DD} = 2\text{ V}$ to 3.6 V , and $f_c = 2394\text{ MHz}$ to 2507 MHz .

PARAMETER	TEST CONDITIONS	MIN	TYP	MAX	UNIT
Nominal output power	Delivered to a single-ended 50-Ω load through a balun using maximum-recommended output-power setting (¹) requires minimum -3 dBm		7		dBm
Programmable output-power range			30		dB
Spurious emissions	Maximum recommended output power setting (²) Measured according to stated regulations.				
Only largest spurious emission stated within each band.	25–1000 MHz (outside restricted bands) 25–1000 MHz (within FCC restricted bands) 25–1000 MHz (within ETSI restricted bands) 1800–1900 MHz (ETSI restricted band) 5150–5300 MHz (ETSI restricted band) 1–12.75 GHz (except restricted bands) At 2483.5 MHz and above (FCC restricted band), $f_c = 2480\text{ MHz}$ (³)		-56 -58 -58 -60 -54 -51 -42		dBm
Error vector magnitude (EVM)	Measured as defined by (¹) using maximum-recommended output-power setting (¹) requires maximum 35%.		3%		
Optimum load impedance	Differential impedance on the RF pins		66 + j64		Ω

- (1) IEEE Std. 802.15.4-2006: Wireless Medium Access Control (MAC) and Physical Layer (PHY) Specifications for Low-Rate Wireless Personal Area Networks (LR-WPANS)
<http://standards.ieee.org/getieee802/download/802.15.4-2006.pdf>
- (2) TI's CC2538 EM reference design is suitable for systems targeting compliance with EN 300 328, EN 300 440, FCC CFR47 Part 15, and ARIB STD-T-66.
- (3) To improve margins for passing FCC requirements at 2483.5 MHz and above when transmitting at 2480 MHz, use a lower output-power setting or less than 100% duty cycle.

5.8 32-MHz Crystal Oscillator

Measured on TI's CC2538 EM reference design with $T_A = 25^\circ\text{C}$ and $V_{DD} = 3\text{ V}$, unless otherwise noted.

PARAMETER		TEST CONDITIONS	MIN	TYP	MAX	UNIT
Crystal frequency			32			MHz
Crystal frequency accuracy requirement ⁽¹⁾			-40		40	ppm
ESR	Equivalent series resistance		6	16	60	Ω
C_0	Crystal shunt capacitance		1	1.9	7	pF
C_L	Crystal load capacitance		10	13	16	pF
Start-up time			0.3			ms
Power-down guard time		The crystal oscillator must be in power down for a guard time before using it again. This requirement is valid for all modes of operation. The need for power-down guard time can vary with crystal type and load.	3			ms

- (1) Including aging and temperature dependency, as specified by IEEE Std. 802.15.4-2006: Wireless Medium Access Control (MAC) and Physical Layer (PHY) Specifications for Low-Rate Wireless Personal Area Networks (LR-WPANs)
<http://standards.ieee.org/getieee802/download/802.15.4-2006.pdf>

5.9 32.768-kHz Crystal Oscillator

Measured on TI's CC2538 EM reference design with $T_A = 25^\circ\text{C}$ and $V_{DD} = 3\text{ V}$, unless otherwise noted.

PARAMETER		TEST CONDITIONS	MIN	TYP	MAX	UNIT
Crystal frequency			32.768			kHz
Crystal frequency accuracy requirement ⁽¹⁾			-40		40	ppm
ESR	Equivalent series resistance			40	130	Ω
C_0	Crystal shunt capacitance			0.9	2	pF
C_L	Crystal load capacitance			12	16	pF
Start-up time			0.4			s

- (1) Including aging and temperature dependency, as specified by IEEE Std. 802.15.4-2006: Wireless Medium Access Control (MAC) and Physical Layer (PHY) Specifications for Low-Rate Wireless Personal Area Networks (LR-WPANs)
<http://standards.ieee.org/getieee802/download/802.15.4-2006.pdf>

5.10 32-kHz RC Oscillator

Measured on TI's CC2538 EM reference design with $T_A = 25^\circ\text{C}$ and $V_{DD} = 3\text{ V}$, unless otherwise noted.

PARAMETER		TEST CONDITIONS	MIN	TYP	MAX	UNIT
Calibrated frequency ⁽¹⁾			32.753			kHz
Frequency accuracy after calibration			$\pm 0.2\%$			
Temperature coefficient ⁽²⁾			0.4			%/°C
Supply-voltage coefficient ⁽³⁾			3			%/V
Calibration time ⁽⁴⁾			2			ms

- (1) The calibrated 32-kHz RC oscillator frequency is the 32-MHz XTAL frequency divided by 977.
 (2) Frequency drift when temperature changes after calibration
 (3) Frequency drift when supply voltage changes after calibration
 (4) When the 32-kHz RC oscillator is enabled, it is calibrated when a switch from the 16-MHz RC oscillator to the 32-MHz crystal oscillator is performed while SLEEP_CMD.OSC32K_CALDIS is 0.

5.11 16-MHz RC Oscillator

Measured on TI's CC2538 EM reference design with $T_A = 25^\circ\text{C}$ and $V_{DD} = 3\text{ V}$, unless otherwise noted.

PARAMETER	TEST CONDITIONS	MIN	TYP	MAX	UNIT
Frequency ⁽¹⁾			16		MHz
Uncalibrated frequency accuracy			±18%		
Calibrated frequency accuracy			±0.6%	±1%	
Start-up time				10	µs
Initial calibration time ⁽²⁾			50		µs

(1) The calibrated 16-MHz RC oscillator frequency is the 32-MHz xtal frequency divided by 2.

(2) When the 16-MHz RC oscillator is enabled, it is calibrated when a switch from the 16-MHz RC oscillator to the 32-MHz crystal oscillator is performed while SLEEP_CMD.OSC_PD is set to 0.

5.12 RSSI/CCA Characteristics

Measured on TI's CC2538 EM reference design with $T_A = 25^\circ\text{C}$ and $V_{DD} = 3\text{ V}$, unless otherwise noted.

PARAMETER	TEST CONDITIONS	MIN	TYP	MAX	UNIT
RSSI range			100		dB
Absolute uncalibrated RSSI/CCA accuracy			±4		dB
RSSI/CCA offset ⁽¹⁾			73		dB
Step size (LSB value)			1		dB

(1) Real RSSI = Register value – offset

5.13 FREQUEST Characteristics

Measured on TI's CC2538 EM reference design with $T_A = 25^\circ\text{C}$ and $V_{DD} = 3\text{ V}$, unless otherwise noted.

PARAMETER	TEST CONDITIONS	MIN	TYP	MAX	UNIT
FREQUEST range			±250		kHz
FREQUEST accuracy			±10		kHz
FREQUEST offset ⁽¹⁾			15		kHz
Step size (LSB value)			7.8		kHz

(1) Real FREQUEST = Register value – offset

5.14 Frequency Synthesizer Characteristics

Measured on TI's CC2538 EM reference design with $T_A = 25^\circ\text{C}$, $V_{DD} = 3\text{ V}$ and $f_c = 2440\text{ MHz}$, unless otherwise noted.

PARAMETER	TEST CONDITIONS	MIN	TYP	MAX	UNIT
Phase noise, unmodulated carrier	At ±1-MHz offset from carrier		-111		dBc/Hz
	At ±2-MHz offset from carrier		-119		
	At ±5-MHz offset from carrier		-126		

5.15 Analog Temperature Sensor

Measured on TI's CC2538 EM reference design with $T_A = 25^\circ\text{C}$ and $V_{DD} = 3\text{ V}$, unless otherwise noted.

PARAMETER	TEST CONDITIONS	MIN	TYP	MAX	UNIT
Output at 25°C	Measured using integrated ADC, using internal band-gap voltage reference and maximum resolution		1422		12-bit ADC
Temperature coefficient			4.2		/1°C
Voltage coefficient			1		/0.1 V
Initial accuracy without calibration			±10		°C
Accuracy using 1-point calibration (entire temperature range)			±5		°C
Current consumption when enabled (ADC current not included)				0.3	

5.16 ADC Characteristics

$T_A = 25^\circ\text{C}$ and $V_{DD} = 3\text{ V}$, unless otherwise noted.

PARAMETER		TEST CONDITIONS	MIN	TYP	MAX	UNIT
	Input voltage	V_{DD} is voltage on AVDD5 pin	0		V_{DD}	V
	External reference voltage	V_{DD} is voltage on AVDD5 pin	0		V_{DD}	V
	External reference voltage differential	V_{DD} is voltage on AVDD5 pin	0		V_{DD}	V
	Input resistance, signal	Using 4-MHz clock speed		197		k Ω
	Full-scale signal ⁽¹⁾	Peak-to-peak, defines 0 dBFS		2.97		V
ENOB ⁽¹⁾	Effective number of bits	Single-ended input, 7-bit setting		5.7		Bits
		Single-ended input, 9-bit setting		7.5		
		Single-ended input, 10-bit setting		9.3		
		Single-ended input, 12-bit setting		10.8		
		Differential input, 7-bit setting		6.5		
		Differential input, 9-bit setting		8.3		
		Differential input, 10-bit setting		10.0		
	Useful power bandwidth	7-bit setting, both single and differential		0–20		kHz
THD ⁽¹⁾	Total harmonic distortion	Single-ended input, 12-bit setting, –6 dBFS		–75.2		dB
		Differential input, 12-bit setting, –6 dBFS		–86.6		
	Signal to nonharmonic ratio ⁽¹⁾	Single-ended input, 12-bit setting		70.2		dB
		Differential input, 12-bit setting		79.3		
		Single-ended input, 12-bit setting, –6 dBFS		78.8		
		Differential input, 12-bit setting, –6 dBFS		88.9		
CMRR	Common-mode rejection ratio	Differential input, 12-bit setting, 1-kHz sine (0 dBFS), limited by ADC resolution		>84		dB
	Crosstalk	Single-ended input, 12-bit setting, 1-kHz sine (0 dBFS), limited by ADC resolution		< –84		dB
	Offset	Midscale		–3		mV
	Gain error			0.68%		
DNL ⁽¹⁾	Differential nonlinearity	12-bit setting, mean		0.05		LSB
		12-bit setting, maximum		0.9		
INL ⁽¹⁾	Integral nonlinearity	12-bit setting, mean		4.6		LSB
		12-bit setting, maximum		13.3		
SINAD ⁽¹⁾ (–THD+N)	Signal-to-noise-and-distortion	Single-ended input, 7-bit setting		35.4		dB
		Single-ended input, 9-bit setting		46.8		
		Single-ended input, 10-bit setting		57.5		
		Single-ended input, 12-bit setting		66.6		
		Differential input, 7-bit setting		40.7		
		Differential input, 9-bit setting		51.6		
		Differential input, 10-bit setting		61.8		
	Conversion time	7-bit setting		20		μs
		9-bit setting		36		
		10-bit setting		68		
		12-bit setting		132		
	Current consumption			1.2		mA
	Internal reference voltage			1.19		V
	Internal reference VDD coefficient			2		mV/V

(1) Measured with 300-Hz sine-wave input and VDD as reference

ADC Characteristics (continued)

T_A = 25°C and V_{DD} = 3 V, unless otherwise noted.

PARAMETER	TEST CONDITIONS	MIN	TYP	MAX	UNIT
Internal reference temperature coefficient			0.4		mV/10 °C

5.17 Control Input AC Characteristics

T_A = -40°C to 125°C, V_{DD} = 2 V to 3.6 V, unless otherwise noted.

PARAMETER	TEST CONDITIONS	MIN	TYP	MAX	UNIT
System clock, f _{SYSCLK} t _{SYSCLK} = 1/f _{SYSCLK}	The undivided system clock is 32 MHz when crystal oscillator is used. The undivided system clock is 16 MHz when calibrated 16-MHz RC oscillator is used.	16		32	MHz
RESET_N low duration ⁽¹⁾	See item 1, Figure 5-1. This is the shortest pulse that is recognized as a complete reset pin request.	1			μs
Interrupt pulse duration	See item 2, Figure 5-1. This is the shortest pulse that is recognized as an interrupt request.	20			ns

(1) Shorter pulses may be recognized, but might not lead to a complete reset of all modules within the chip.

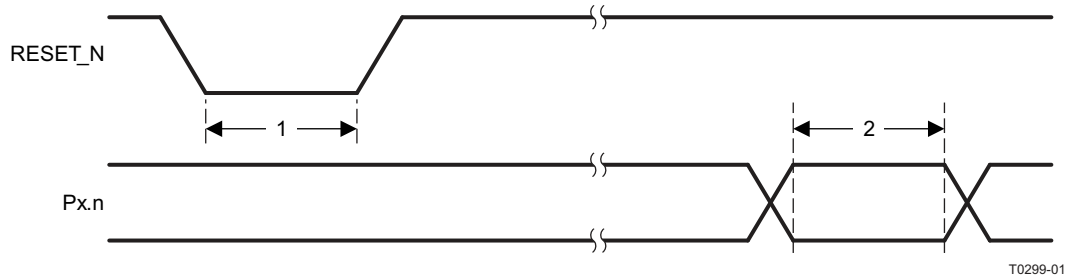

Figure 5-1. Control Input AC Characteristics

5.18 DC Characteristics

T_A = 25°C, V_{DD} = 3 V, drive strength set to high with CC_TESTCTRL.SC = 1, unless otherwise noted.

PARAMETER	TEST CONDITIONS	MIN	TYP	MAX	UNIT
Logic-0 input voltage				0.5	V
Logic-1 input voltage		2.5			V
Logic-0 input current	Input equals 0 V	-300		300	nA
Logic-1 input current	Input equals V _{DD}	-300		300	nA
I/O-pin pullup and pulldown resistors			20		kΩ
Logic-0 output voltage, 4-mA pins	Output load 4 mA			0.5	V
Logic-1 output voltage, 4-mA pins	Output load 4 mA	2.4			V
Logic-0 output voltage, 20-mA pins	Output load 20 mA			0.5	V
Logic-1 output voltage, 20-mA pins	Output load 20 mA	2.4			V

5.19 USB Interface DC Characteristics

T_A = 25°C, V_{DD} = 3 V to 3.6 V, unless otherwise noted.

PARAMETER	TEST CONDITIONS	MIN	TYP	MAX	UNIT
USB pad voltage output, high	V _{DD} 3.6 V, 4-mA load		3.4		V
USB pad voltage output, low	V _{DD} 3.6 V, 4-mA load		0.2		V

5.20 Thermal Resistance Characteristics for RTQ Package

NAME	DESCRIPTION	°C/W ⁽¹⁾ (2)	AIR FLOW (m/s) ⁽³⁾
R θ_{JC-top}	Junction-to-case (top)	8.9	0.00
R θ_{JB}	Junction-to-board	3.1	0.00
R θ_{JA}	Junction-to-free air	25.0	0.00
Psi $_{JT}$	Junction-to-package top	3.1	0.00
Psi $_{JB-bottom}$	Junction-to-board (bottom)	0.4	0.00

(1) °C/W = degrees Celsius per watt.

(2) These values are based on a JEDEC-defined 2S2P system (with the exception of the Theta JC [R θ_{JC}] value, which is based on a JEDEC-defined 1S0P system) and will change based on environment as well as application. For more information, see these EIA/JEDEC standards:

- JESD51-2, *Integrated Circuits Thermal Test Method Environmental Conditions - Natural Convection (Still Air)*
- JESD51-3, *Low Effective Thermal Conductivity Test Board for Leaded Surface Mount Packages*
- JESD51-7, *High Effective Thermal Conductivity Test Board for Leaded Surface Mount Packages*
- JESD51-9, *Test Boards for Area Array Surface Mount Package Thermal Measurements*

(3) m/s = meters per second.

6 Applications, Implementation, and Layout

NOTE

Information in the following applications sections is not part of the TI component specification, and TI does not warrant its accuracy or completeness. TI's customers are responsible for determining suitability of components for their purposes. Customers should validate and test their design implementation to confirm system functionality.

Few external components are required for the operation of the CC2538xFnn. Figure 6-1 is a typical application circuit. For a complete USB reference design, see the CC2538xFnn product page on www.ti.com. Table 6-1 lists typical values and descriptions of external components. The USB_P and USB_N pins require series resistors R21 and R31 for impedance matching, and the D+ line must have a pullup resistor, R32. The series resistors should match the 90-Ω ±15% characteristic impedance of the USB bus. Notice that the pullup resistor and DVDD_USB require connection to a voltage source between 3 V and 3.6 V (typically 3.3 V). To accomplish this, it is recommended to connect the D+ pull-up to a port/pin that does not have an internal pullup (that is, PC0..3), instead of connecting it directly to a 3.3 V supply (that is, software control of D+ pullup recommended).

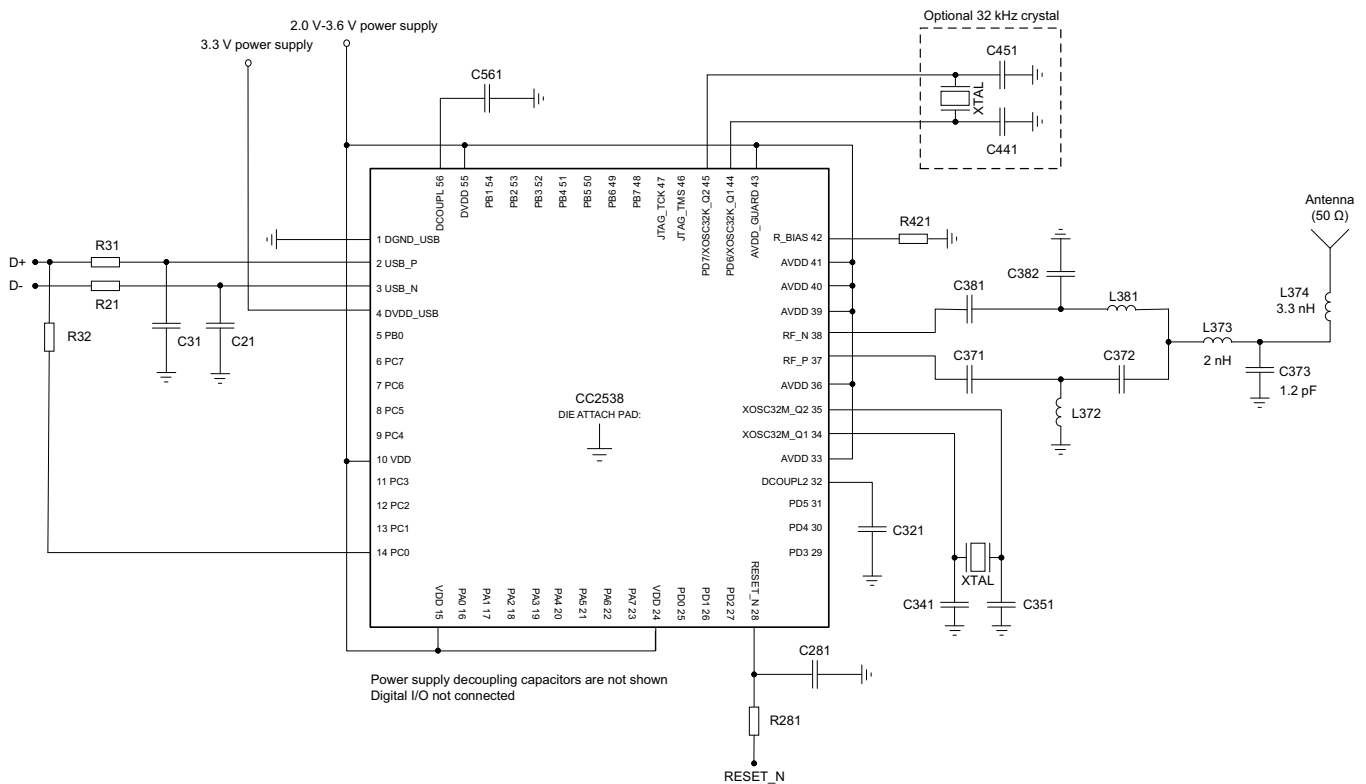

Figure 6-1. CC2538xFnn Application Circuit

Table 6-1. Overview of External Components (Excluding Supply Decoupling Capacitors)

Component	Description	Value
C21	USB D– decoupling	47 pF
C31	USB D+ decoupling	47 pF
C341	32-MHz xtal-loading capacitor	12 pF
C351	32-MHz xtal-loading capacitor	12 pF
C371	Part of the RF matching network	18 pF
C381	Part of the RF matching network	18 pF
C382	Part of the RF matching network	1 pF
C372	Part of the RF matching network	1 pF
C441	32-kHz xtal-loading capacitor	22 pF
C451	32-kHz xtal-loading capacitor	22 pF
C561	Decoupling capacitor for the internal digital regulator	1 μF
C321	Decoupling capacitor for the internal digital regulator	1 μF
C281	Filter capacitor for reset line	1 nF
L372	Part of the RF matching network	2 nH
L381	Part of the RF matching network	2 nH
R21	USB D– series resistor	33 Ω
R31	USB D+ series resistor	33 Ω
R32	USB D+ pullup resistor to signal full-speed device presence	1.5 kΩ
R281	Filter resistor for reset line	2.2 Ω
R421	Resistor used for internal biasing	56 kΩ

6.1 Input, Output Matching

When using an unbalanced antenna such as a monopole, use a balun to optimize performance. One can implement the balun using low-cost, discrete inductors and capacitors. The recommended balun shown in [Figure 6-1](#) consists of L372, C372, C382 and L381.

If a balanced antenna such as a folded dipole is used, omit the balun.

6.2 Crystal

The 32-MHz crystal oscillator uses an external 32-MHz crystal, XTAL1, with two loading capacitors (C341 and C351). See the [32-MHz Crystal Oscillator](#) section for details. Calculate the load capacitance across the 32-MHz crystal by [Equation 1](#).

$$C_L = \frac{1}{\frac{1}{C_{341}} + \frac{1}{C_{351}}} + C_{\text{parasitic}} \quad (1)$$

XTAL2 is an optional 32.768-kHz crystal, with two loading capacitors (C441 and C451) used for the 32.768-kHz crystal oscillator. Use the 32.768-kHz crystal oscillator in applications where both low sleep-current consumption and accurate wake-up times are needed. Calculate the load capacitance across the 32.768-kHz crystal by [Equation 2](#).

$$C_L = \frac{1}{\frac{1}{C_{441}} + \frac{1}{C_{451}}} + C_{\text{parasitic}} \quad (2)$$

Use a series resistor, if necessary, to comply with the ESR requirement.

6.3 On-Chip 1.8-V Voltage-Regulator Decoupling

The 1.8-V on-chip voltage regulator supplies the 1.8-V digital logic. This regulator requires decoupling capacitors (C561, C321) and an external connection between them for stable operation.

6.4 Power-Supply Decoupling and Filtering

Optimum performance requires proper power-supply decoupling. The placement and size of the decoupling capacitors and the power supply filtering are important to achieve the best performance in an application. TI provides a recommended compact reference design for the user to follow.

6.5 References

1. IEEE Std. 802.15.4-2006: Wireless Medium Access Control (MAC) and Physical Layer (PHY) Specifications for Low-Rate Wireless Personal Area Networks
<http://standards.ieee.org/getieee802/download/802.15.4-2006.pdf>
2. CC2538xFnn User's Guide
3. Universal Serial Bus Revision 2.0 Specification
http://www.usb.org/developers/docs/usb_20_052709.zip

7 Device and Documentation Support

7.1 Device Support

7.1.1 Development Support

TI offers an extensive line of development tools, including tools to evaluate the performance of the processors, generate code, develop algorithm implementations, and fully integrate and debug software and hardware modules. The tool's support documentation is electronically available within the Code Composer Studio™ Integrated Development Environment (IDE).

The following products support development of the CC2538 device applications:

Software Development Tools: Code Composer Studio™ Integrated Development Environment (IDE): including Editor C/C++/Assembly Code Generation, and Debug plus additional development tools Scalable, Real-Time Foundation Software (DSP/BIOS™), which provides the basic run-time target software needed to support any CC2538 device application.

Hardware Development Tools: Extended Development System (XDS™) Emulator

For a complete listing of development-support tools for the CC2538 platform, visit the Texas Instruments website at www.ti.com. For information on pricing and availability, contact the nearest TI field sales office or authorized distributor.

7.1.2 Device Nomenclature

To designate the stages in the product development cycle, TI assigns prefixes to the part numbers of all microprocessors (MPUs) and support tools. Each device has one of three prefixes: X, P, or null (no prefix) (for example, CC2538).

Device development evolutionary flow:

- X** Experimental device that is not necessarily representative of the final device's electrical specifications and may not use production assembly flow.
- P** Prototype device that is not necessarily the final silicon die and may not necessarily meet final electrical specifications.
- null** Production version of the silicon die that is fully qualified.

Support tool development evolutionary flow:

X and P devices are shipped against the following disclaimer:

"Developmental product is intended for internal evaluation purposes."

Production devices have been characterized fully, and the quality and reliability of the device have been demonstrated fully. TI's standard warranty applies.

Predictions show that prototype devices (X or P) have a greater failure rate than the standard production devices. Texas Instruments recommends that these devices not be used in any production system because their expected end-use failure rate still is undefined. Only qualified production devices are to be used.

TI device nomenclature also includes a suffix with the device family name. This suffix indicates the package type (for example, RTQ) and the temperature range (for example, blank is the default commercial temperature range).

For orderable part numbers of CC2538 devices in the RTQ package types, see the Package Option Addendum of this document, the TI website (www.ti.com), or contact your TI sales representative.

7.2 Documentation Support

The following documents describe the CC2538 processor. Copies of these documents are available on the Internet at www.ti.com.

- SWRZ045** CC2538 SoC for 2.4-GHz IEEE 802.15.4, 6LoWPAN and ZigBee Applications Errata
- SWRA467** Developing a Low-Cost, Zigbee-Enabled Smart Energy Meter On CC2538
- SWRA456** Pwr Consumption Meas & Optimization for CC2538 End Device With Z-Stack
- SWRA447** Using CC2592 Front End with CC2538
- SWRA437** CC2538 + CC1200 Evaluation Module
- SWRA443** Using GCC/GDB With CC2538
- SWRU325** CC2538 Peripheral Driver Library User's Guide
- SWRU319** CC2538 SoC for 2.4-GHz IEEE 802.15.4 & ZigBee/ZigBee IP Apps User's Guide
- SWRU333** CC2538 ROM User's Guide

7.2.1 Community Resources

The following links connect to TI community resources. Linked contents are provided "AS IS" by the respective contributors. They do not constitute TI specifications and do not necessarily reflect TI's views; see TI's [Terms of Use](#).

TI E2E™ Online Community *TI's Engineer-to-Engineer (E2E) Community*. Created to foster collaboration among engineers. At e2e.ti.com, you can ask questions, share knowledge, explore ideas and help solve problems with fellow engineers.

TI Embedded Processors Wiki *Texas Instruments Embedded Processors Wiki*. Established to help developers get started with Embedded Processors from Texas Instruments and to foster innovation and growth of general knowledge about the hardware and software surrounding these devices.

7.3 Additional Information

Texas Instruments offers a wide selection of cost-effective, low-power RF solutions for proprietary and standard-based wireless applications for use in industrial and consumer applications. The selection includes RF transceivers, RF transmitters, RF front ends, and Systems-on-Chips as well as various software solutions for the sub-1-GHz and 2.4-GHz frequency bands.

In addition, Texas Instruments provides a large selection of support collateral such as development tools, technical documentation, reference designs, application expertise, customer support, third-party and university programs.

The Low-Power RF E2E Online Community provides technical support forums, videos and blogs, and the chance to interact with engineers from all over the world.

With a broad selection of product solutions, end-application possibilities, and a range of technical support, Texas Instruments offers the broadest low-power RF portfolio.

7.3.1 Texas Instruments Low-Power RF Web Site

Texas Instruments' Low-Power RF website has all the latest products, application and design notes, FAQ section, news and events updates. Go to www.ti.com/lprf.

7.3.2 Low-Power RF Online Community

- Forums, videos, and blogs
- RF design help
- E2E interaction

Join at: www.ti.com/lprf-forum.

7.3.3 Texas Instruments Low-Power RF Developer Network

Texas Instruments has launched an extensive network of low-power RF development partners to help customers speed up their application development. The network consists of recommended companies, RF consultants, and independent design houses that provide a series of hardware module products and design services, including:

- RF circuit, low-power RF, and ZigBee design services
- Low-power RF and ZigBee module solutions and development tools
- RF certification services and RF circuit manufacturing

For help with modules, engineering services or development tools:

Search the [Low-Power RF Developer Network](http://www.ti.com/lprfnetwork) to find a suitable partner. www.ti.com/lprfnetwork

7.3.4 Low-Power RF eNewsletter

The Low-Power RF eNewsletter is up-to-date on new products, news releases, developers' news, and other news and events associated with low-power RF products from TI. The Low-Power RF eNewsletter articles include links to get more online information.

Sign up at: www.ti.com/lprfnewsletter

7.4 Trademarks

Code Composer Studio, SmartRF, E2E are trademarks of Texas Instruments.

Cortex is a registered trademark of ARM Limited.

ARM is a registered trademark of ARM Physical IP, Inc.

IAR Embedded Workbench is a registered trademark of IAR Systems AB.

ZigBee is a registered trademark of ZigBee Alliance.

7.5 Electrostatic Discharge Caution



This integrated circuit can be damaged by ESD. Texas Instruments recommends that all integrated circuits be handled with appropriate precautions. Failure to observe proper handling and installation procedures can cause damage.

ESD damage can range from subtle performance degradation to complete device failure. Precision integrated circuits may be more susceptible to damage because very small parametric changes could cause the device not to meet its published specifications.

7.6 Export Control Notice

Recipient agrees to not knowingly export or re-export, directly or indirectly, any product or technical data (as defined by the U.S., EU, and other Export Administration Regulations) including software, or any controlled product restricted by other applicable national regulations, received from disclosing party under nondisclosure obligations (if any), or any direct product of such technology, to any destination to which such export or re-export is restricted or prohibited by U.S. or other applicable laws, without obtaining prior authorization from U.S. Department of Commerce and other competent Government authorities to the extent required by those laws.

7.7 Glossary

[TI Glossary](#) This glossary lists and explains terms, acronyms, and definitions.

8 Mechanical Packaging and Orderable Information

8.1 Packaging Information

The following pages include mechanical packaging and orderable information. This information is the most current data available for the designated devices. This data is subject to change without notice and revision of this document. For browser-based versions of this data sheet, refer to the left-hand navigation.

PACKAGING INFORMATION

Orderable Device	Status (1)	Package Type	Package Drawing	Pins	Package Qty	Eco Plan (2)	Lead finish/ Ball material (6)	MSL Peak Temp (3)	Op Temp (°C)	Device Marking (4/5)	Samples
CC2538NF11RTQR	ACTIVE	QFN	RTQ	56	2000	RoHS & Green	NIPDAU	Level-3-260C-168 HR	-40 to 125	CC2538NF11	Samples
CC2538NF11RTQT	ACTIVE	QFN	RTQ	56	250	RoHS & Green	NIPDAU	Level-3-260C-168 HR	-40 to 125	CC2538NF11	Samples
CC2538NF23RTQR	ACTIVE	QFN	RTQ	56	2000	RoHS & Green	NIPDAU	Level-3-260C-168 HR	-40 to 125	CC2538NF23	Samples
CC2538NF23RTQT	ACTIVE	QFN	RTQ	56	250	RoHS & Green	NIPDAU	Level-3-260C-168 HR	-40 to 125	CC2538NF23	Samples
CC2538NF53RTQR	ACTIVE	QFN	RTQ	56	2000	RoHS & Green	NIPDAU	Level-3-260C-168 HR	-40 to 125	CC2538NF53	Samples
CC2538NF53RTQT	ACTIVE	QFN	RTQ	56	250	RoHS & Green	NIPDAU	Level-3-260C-168 HR	-40 to 125	CC2538NF53	Samples
CC2538SF23RTQR	ACTIVE	QFN	RTQ	56	2000	RoHS & Green	NIPDAU	Level-3-260C-168 HR	-40 to 125	CC2538SF23	Samples
CC2538SF23RTQT	ACTIVE	QFN	RTQ	56	250	RoHS & Green	NIPDAU	Level-3-260C-168 HR	-40 to 125	CC2538SF23	Samples
CC2538SF53RTQR	ACTIVE	QFN	RTQ	56	2000	RoHS & Green	NIPDAU	Level-3-260C-168 HR	-40 to 125	CC2538SF53	Samples
CC2538SF53RTQT	ACTIVE	QFN	RTQ	56	250	RoHS & Green	NIPDAU	Level-3-260C-168 HR	-40 to 125	CC2538SF53	Samples

(1) The marketing status values are defined as follows:

ACTIVE: Product device recommended for new designs.

LIFEBUY: TI has announced that the device will be discontinued, and a lifetime-buy period is in effect.

NRND: Not recommended for new designs. Device is in production to support existing customers, but TI does not recommend using this part in a new design.

PREVIEW: Device has been announced but is not in production. Samples may or may not be available.

OBSOLETE: TI has discontinued the production of the device.

(2) **RoHS:** TI defines "RoHS" to mean semiconductor products that are compliant with the current EU RoHS requirements for all 10 RoHS substances, including the requirement that RoHS substance do not exceed 0.1% by weight in homogeneous materials. Where designed to be soldered at high temperatures, "RoHS" products are suitable for use in specified lead-free processes. TI may reference these types of products as "Pb-Free".

RoHS Exempt: TI defines "RoHS Exempt" to mean products that contain lead but are compliant with EU RoHS pursuant to a specific EU RoHS exemption.

Green: TI defines "Green" to mean the content of Chlorine (Cl) and Bromine (Br) based flame retardants meet JS709B low halogen requirements of <=1000ppm threshold. Antimony trioxide based flame retardants must also meet the <=1000ppm threshold requirement.

(3) MSL, Peak Temp. - The Moisture Sensitivity Level rating according to the JEDEC industry standard classifications, and peak solder temperature.

(4) There may be additional marking, which relates to the logo, the lot trace code information, or the environmental category on the device.

⁽⁵⁾ Multiple Device Markings will be inside parentheses. Only one Device Marking contained in parentheses and separated by a "~" will appear on a device. If a line is indented then it is a continuation of the previous line and the two combined represent the entire Device Marking for that device.

⁽⁶⁾ Lead finish/Ball material - Orderable Devices may have multiple material finish options. Finish options are separated by a vertical ruled line. Lead finish/Ball material values may wrap to two lines if the finish value exceeds the maximum column width.

Important Information and Disclaimer: The information provided on this page represents TI's knowledge and belief as of the date that it is provided. TI bases its knowledge and belief on information provided by third parties, and makes no representation or warranty as to the accuracy of such information. Efforts are underway to better integrate information from third parties. TI has taken and continues to take reasonable steps to provide representative and accurate information but may not have conducted destructive testing or chemical analysis on incoming materials and chemicals. TI and TI suppliers consider certain information to be proprietary, and thus CAS numbers and other limited information may not be available for release.

In no event shall TI's liability arising out of such information exceed the total purchase price of the TI part(s) at issue in this document sold by TI to Customer on an annual basis.

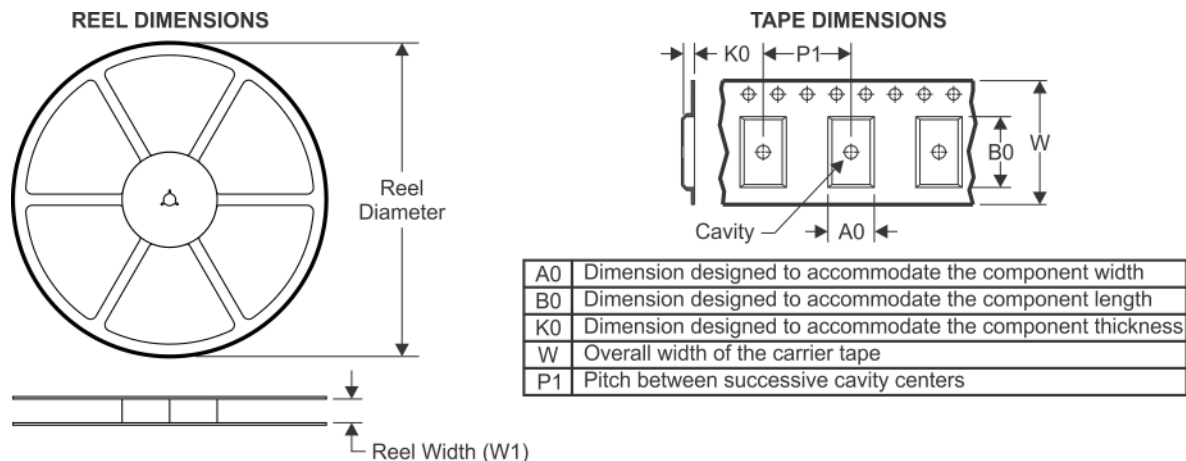
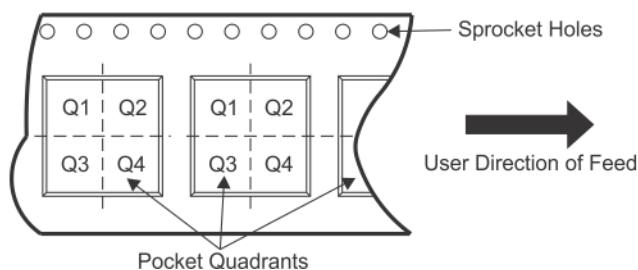
TAPE AND REEL INFORMATION

QUADRANT ASSIGNMENTS FOR PIN 1 ORIENTATION IN TAPE

*All dimensions are nominal

Device	Package Type	Package Drawing	Pins	SPQ	Reel Diameter (mm)	Reel Width W1 (mm)	A0 (mm)	B0 (mm)	K0 (mm)	P1 (mm)	W (mm)	Pin1 Quadrant
CC2538NF11RTQR	QFN	RTQ	56	2000	330.0	16.4	8.3	8.3	2.25	12.0	16.0	Q2
CC2538NF23RTQR	QFN	RTQ	56	2000	330.0	16.4	8.3	8.3	2.25	12.0	16.0	Q2
CC2538NF53RTQR	QFN	RTQ	56	2000	330.0	16.4	8.3	8.3	2.25	12.0	16.0	Q2
CC2538SF23RTQR	QFN	RTQ	56	2000	330.0	16.4	8.3	8.3	2.25	12.0	16.0	Q2
CC2538SF53RTQR	QFN	RTQ	56	2000	330.0	16.4	8.3	8.3	2.25	12.0	16.0	Q2

TAPE AND REEL BOX DIMENSIONS

*All dimensions are nominal

Device	Package Type	Package Drawing	Pins	SPQ	Length (mm)	Width (mm)	Height (mm)
CC2538NF11RTQR	QFN	RTQ	56	2000	350.0	350.0	43.0
CC2538NF23RTQR	QFN	RTQ	56	2000	350.0	350.0	43.0
CC2538NF53RTQR	QFN	RTQ	56	2000	350.0	350.0	43.0
CC2538SF23RTQR	QFN	RTQ	56	2000	350.0	350.0	43.0
CC2538SF53RTQR	QFN	RTQ	56	2000	350.0	350.0	43.0

GENERIC PACKAGE VIEW

RTQ 56

VQFN - 1 mm max height

8 x 8, 0.5 mm pitch

PLASTIC QUAD FLATPACK - NO LEAD

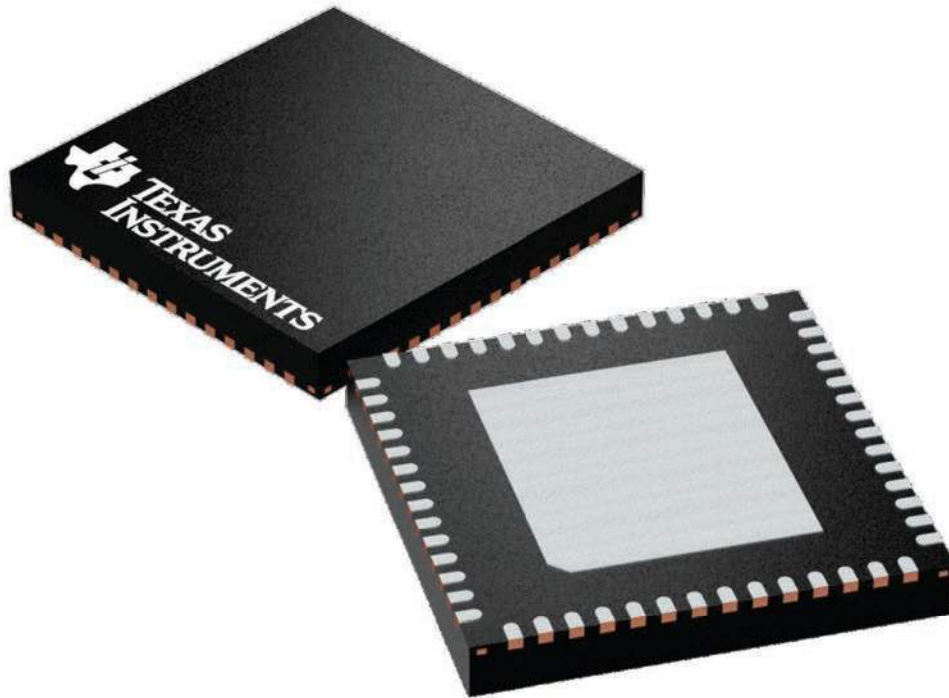

Images above are just a representation of the package family, actual package may vary.
Refer to the product data sheet for package details.

4224653/A

EXAMPLE BOARD LAYOUT

RTQ0056C

VQFN - 1 mm max height

PLASTIC QUAD FLATPACK - NO LEAD

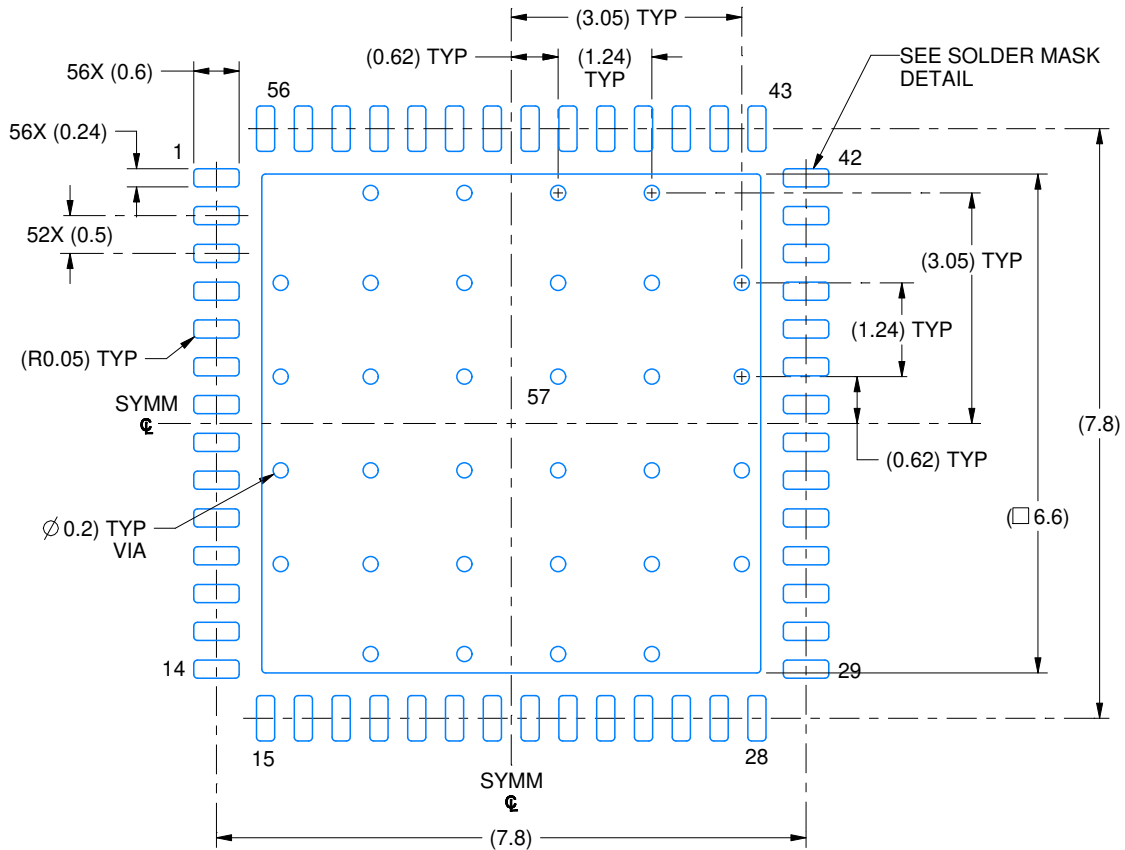

LAND PATTERN EXAMPLE
EXPOSED METAL SHOWN
SCALE: 10X

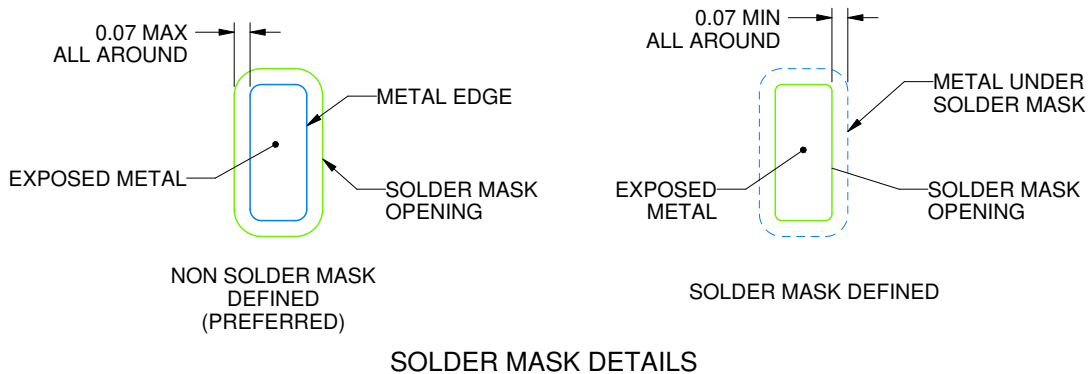

4224872/A 03/2019

NOTES: (continued)

4. This package is designed to be soldered to a thermal pad on the board. For more information, see Texas Instruments literature number SLUA271 (www.ti.com/lit/sluea271).
5. Vias are optional depending on application, refer to device data sheet. If any vias are implemented, refer to their locations shown on this view. It is recommended that vias under paste be filled, plugged or tented.

EXAMPLE STENCIL DESIGN

RTQ0056C

VQFN - 1 mm max height

PLASTIC QUAD FLATPACK - NO LEAD

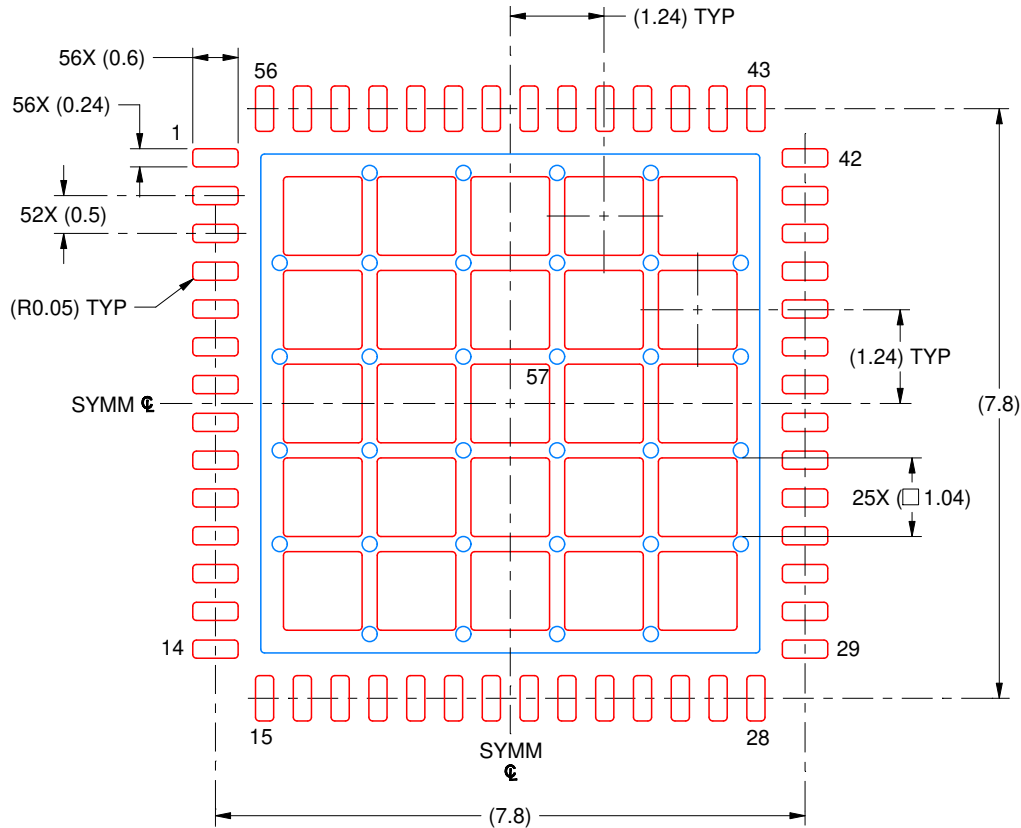

SOLDER PASTE EXAMPLE
 BASED ON 0.125 MM THICK STENCIL
 SCALE: 10X

EXPOSED PAD 57
 62% PRINTED SOLDER COVERAGE BY AREA UNDER PACKAGE

4224872/A 03/2019

NOTES: (continued)

6. Laser cutting apertures with trapezoidal walls and rounded corners may offer better paste release. IPC-7525 may have alternate design recommendations.

IMPORTANT NOTICE AND DISCLAIMER

TI PROVIDES TECHNICAL AND RELIABILITY DATA (INCLUDING DATA SHEETS), DESIGN RESOURCES (INCLUDING REFERENCE DESIGNS), APPLICATION OR OTHER DESIGN ADVICE, WEB TOOLS, SAFETY INFORMATION, AND OTHER RESOURCES "AS IS" AND WITH ALL FAULTS, AND DISCLAIMS ALL WARRANTIES, EXPRESS AND IMPLIED, INCLUDING WITHOUT LIMITATION ANY IMPLIED WARRANTIES OF MERCHANTABILITY, FITNESS FOR A PARTICULAR PURPOSE OR NON-INFRINGEMENT OF THIRD PARTY INTELLECTUAL PROPERTY RIGHTS.

These resources are intended for skilled developers designing with TI products. You are solely responsible for (1) selecting the appropriate TI products for your application, (2) designing, validating and testing your application, and (3) ensuring your application meets applicable standards, and any other safety, security, regulatory or other requirements.

These resources are subject to change without notice. TI grants you permission to use these resources only for development of an application that uses the TI products described in the resource. Other reproduction and display of these resources is prohibited. No license is granted to any other TI intellectual property right or to any third party intellectual property right. TI disclaims responsibility for, and you will fully indemnify TI and its representatives against, any claims, damages, costs, losses, and liabilities arising out of your use of these resources.

TI's products are provided subject to [TI's Terms of Sale](#) or other applicable terms available either on ti.com or provided in conjunction with such TI products. TI's provision of these resources does not expand or otherwise alter TI's applicable warranties or warranty disclaimers for TI products.

TI objects to and rejects any additional or different terms you may have proposed.

Mailing Address: Texas Instruments, Post Office Box 655303, Dallas, Texas 75265
Copyright © 2021, Texas Instruments Incorporated