



STW20NK50Z

N-channel 500 V, 0.23 Ω , 20 A SuperMESH™ Power MOSFET
Zener-protected in TO-247 package

Datasheet — production data

Features

Order code	V _{DSS}	R _{DS(on) max}	I _D	P _W
STW20NK50Z	500 V	< 0.27 Ω	20 A	190 W

- Extremely high dv/dt capability
- 100% avalanche tested
- Gate charge minimized
- Very low intrinsic capacitance

Application

Switching applications

Description

This device is an N-channel Zener-protected Power MOSFET developed using STMicroelectronics' SuperMESH™ technology, achieved through optimization of ST's well established strip-based PowerMESH™ layout. In addition to a significant reduction in on-resistance, this device is designed to ensure a high level of dv/dt capability for the most demanding applications.

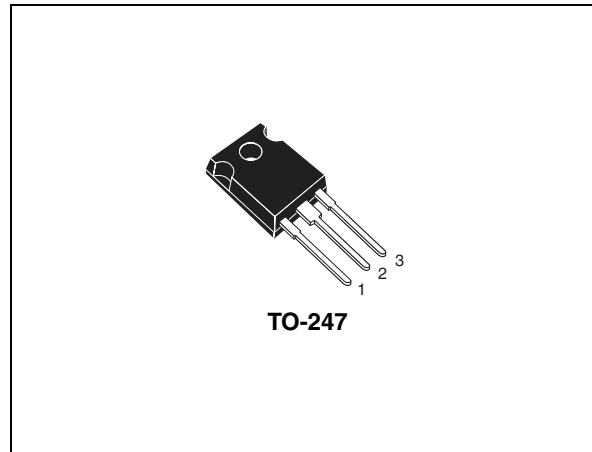
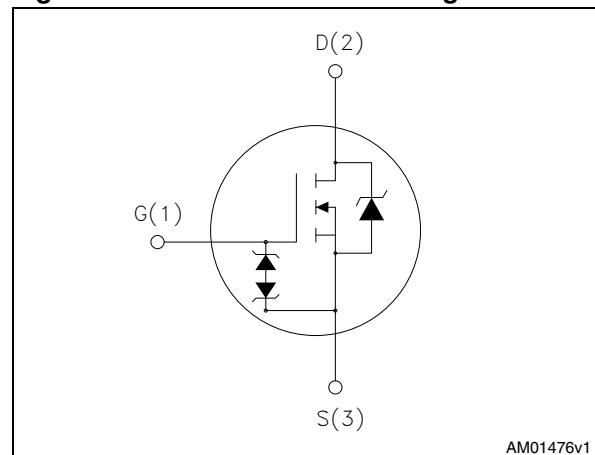

Figure 1. Internal schematic diagram



AM01476v1

Table 1. Device summary

Order code	Marking	Package	Packaging
STW20NK50Z	W20NK50Z	TO-247	Tube

Contents

1	Electrical ratings	3
2	Electrical characteristics	4
	2.1 Electrical characteristics (curves)	6
3	Test circuits	8
4	Package mechanical data	9
5	Revision history	11

1 Electrical ratings

Table 2. Absolute maximum ratings

Symbol	Parameter	Value	Unit
V_{DS}	Drain-source voltage	500	V
V_{GS}	Gate-source voltage	± 30	V
I_D	Drain current (continuous) at $T_C = 25\text{ }^\circ\text{C}$	20	A
I_D	Drain current (continuous) at $T_C = 100\text{ }^\circ\text{C}$	12.6	A
$I_{DM}^{(1)}$	Drain current (pulsed)	68	A
P_{TOT}	Total dissipation at $T_C = 25\text{ }^\circ\text{C}$	190	W
	Derating factor	1.52	W/ $^\circ\text{C}$
ESD	Gate-source human body model ($R=1.5\text{ k}\Omega$, $C=100\text{ pF}$)	6	kV
$dv/dt^{(2)}$	Peak diode recovery voltage slope	4.5	V/ns
T_{stg}	Storage temperature	-55 to 150	$^\circ\text{C}$
T_j	Max operating junction temperature	150	$^\circ\text{C}$

1. Pulse width limited by safe operating area.

2. $I_{SD} \leq 17\text{ A}$, $di/dt \leq 200\text{ A}/\mu\text{s}$, $V_{DS\text{ peak}} \leq V_{(BR)DSS}$, $V_{DD} \leq V_{(BR)DSS}$, $T_j \leq T_{JMAX}$.

Table 3. Thermal data

Symbol	Parameter	Value	Unit
$R_{thj-case}$	Thermal resistance junction-case max	0.66	$^\circ\text{C}/\text{W}$
$R_{thj-amb}$	Thermal resistance junction-ambient max	50	$^\circ\text{C}/\text{W}$

Table 4. Avalanche characteristics

Symbol	Parameter	Value	Unit
I_{AR}	Avalanche current, repetitive or not-repetitive (pulse width limited by T_j Max)	17	A
E_{AS}	Single pulse avalanche energy (starting $T_j=25\text{ }^\circ\text{C}$, $I_D=I_{AR}$, $V_{DD}=50\text{ V}$)	850	mJ

2 Electrical characteristics

($T_{CASE} = 25\text{ °C}$ unless otherwise specified)

Table 5. On/off states

Symbol	Parameter	Test conditions	Min.	Typ.	Max.	Unit
$V_{(BR)DSS}$	Drain-source breakdown voltage	$I_D = 1\text{ mA}$, $V_{GS} = 0$	500			V
I_{DSS}	Zero gate voltage drain current ($V_{GS} = 0$)	$V_{DS} = 500\text{ V}$ $V_{DS} = 500\text{ V}$, $T_C = 125\text{ °C}$			1 50	μA μA
I_{GSS}	Gate-body leakage current ($V_{DS} = 0$)	$V_{GS} = \pm 20\text{ V}$			± 10	μA
$V_{GS(th)}$	Gate threshold voltage	$V_{DS} = V_{GS}$, $I_D = 100\text{ }\mu\text{A}$	3	3.75	4.5	V
$R_{DS(on)}$	Static drain-source on-resistance	$V_{GS} = 10\text{ V}$, $I_D = 8.5\text{ A}$		0.23	0.27	Ω

Table 6. Dynamic

Symbol	Parameter	Test conditions	Min.	Typ.	Max.	Unit	
C_{ISS}	Input capacitance	$V_{DS} = 25\text{ V}$, $f = 1\text{ MHz}$, $V_{GS} = 0$		2600		pF	
C_{OSS}	Output capacitance		-	328		pF	
C_{RSS}	Reverse transfer capacitance				72	pF	
$C_{OSS\text{ eq.}}$ (1)	Equivalent output capacitance	$V_{DS} = 0$, $V_{DS} = 0\text{ to }640\text{ V}$	-	187		pF	
$t_{d(on)}$	Turn-on delay time	$V_{DD} = 250\text{ V}$, $I_D = 8.5\text{ A}$, $R_G = 4.7\text{ }\Omega$, $V_{GS} = 10\text{ V}$ (see Figure 14)		28		ns	
t_r	Rise time		-	20		ns	
$t_{d(off)}$	Turn-off delay time				70		ns
t_f	Fall time				15		ns
Q_g	Total gate charge	$V_{DD} = 400\text{ V}$, $I_D = 17\text{ A}$, $V_{GS} = 10\text{ V}$ (see Figure 15)		85	119	nC	
Q_{gs}	Gate-source charge		-	15.5		nC	
Q_{gd}	Gate-drain charge			42		nC	

1. $C_{OSS\text{ eq.}}$ is defined as a constant equivalent capacitance giving the same charging time as C_{OSS} when V_{DS} increases from 0 to 80% V_{DSS} .

Table 7. Source drain diode

Symbol	Parameter	Test conditions	Min.	Typ.	Max.	Unit
I_{SD}	Source-drain current		-		20	A
$I_{SDM}^{(1)}$	Source-drain current (pulsed)		-		68	A
$V_{SD}^{(2)}$	Forward on voltage	$I_{SD} = 17\text{ A}, V_{GS} = 0$	-		1.6	V
t_{rr}	Reverse recovery time	$I_{SD} = 17\text{ A},$ $di/dt = 100\text{ A}/\mu\text{s}$ $V_R = 100\text{ V}$ (see Figure 16)	-	355		ns
Q_{rr}	Reverse recovery charge			3.90		μC
I_{RRM}	Reverse recovery current			22		A
t_{rr}	Reverse recovery time	$I_{SD} = 17\text{ A},$ $di/dt = 100\text{ A}/\mu\text{s}$ $V_R = 100\text{ V}, T_j = 150\text{ }^\circ\text{C}$ (see Figure 16)	-	440		ns
Q_{rr}	Reverse recovery charge			5.72		μC
I_{RRM}	Reverse recovery current			26		A

1. Pulsed: pulse duration = 300 μs , duty cycle 1.5%

2. Pulse width limited by safe operating area.

Table 8. Gate-source Zener diode

Symbol	Parameter	Test conditions	Min.	Typ.	Max.	Unit
BV_{GSO}	Gate-source breakdown voltage	$I_{GS} = \pm 1\text{ mA}$ (open drain)	30	-		V

The built-in back-to-back Zener diodes have specifically been designed to enhance not only the device's ESD capability, but also to make them safely absorb possible voltage transients that may occasionally be applied from gate to source. In this respect the Zener voltage is appropriate to achieve an efficient and cost-effective intervention to protect the device's integrity. These integrated Zener diodes thus avoid the usage of external components.

2.1 Electrical characteristics (curves)

Figure 2. Safe operating area

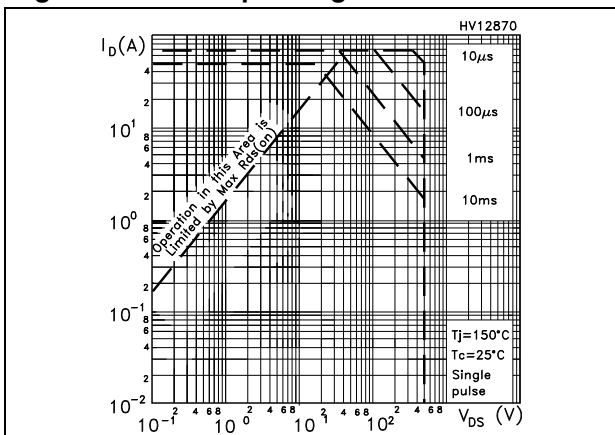

Figure 3. Thermal impedance

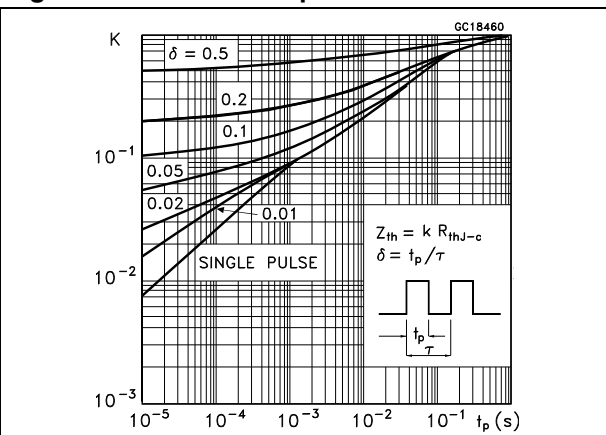

Figure 4. Output characteristics

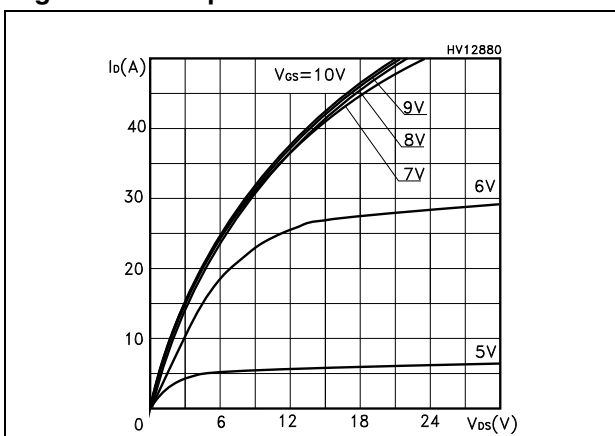

Figure 5. Transfer characteristics

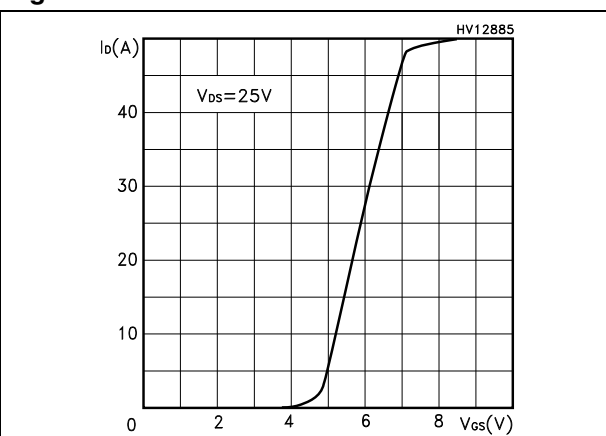

Figure 6. Normalized $B_{V_{DSS}}$ vs temperature

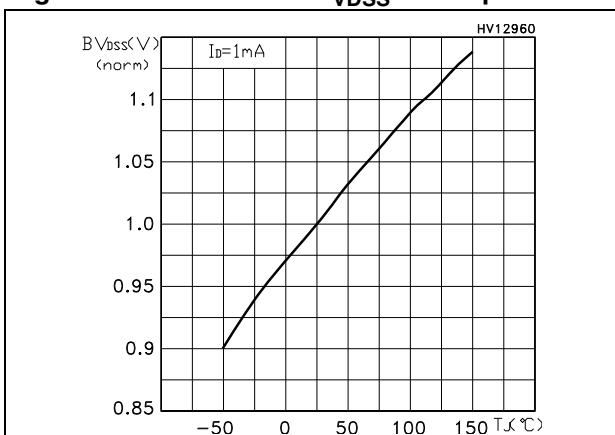

Figure 7. Static drain-source on-resistance

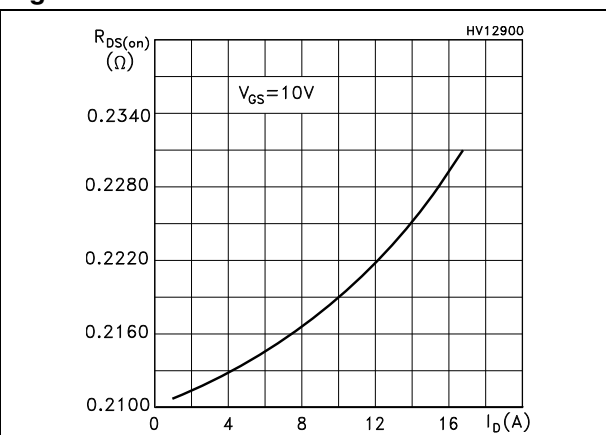

Figure 8. Gate charge vs gate-source voltage Figure 9. Capacitance variations

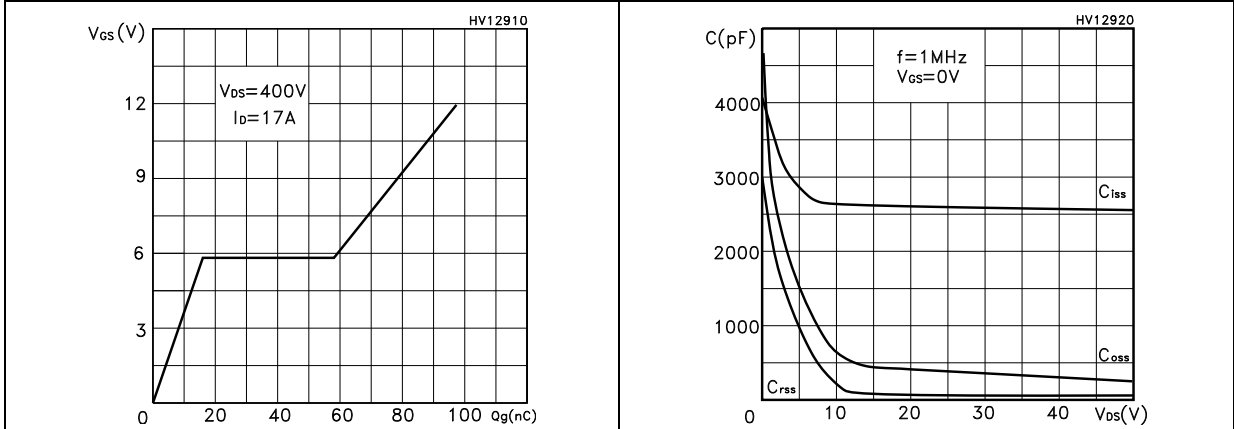

Figure 10. Normalized gate threshold voltage vs temperature Figure 11. Normalized on-resistance vs temperature

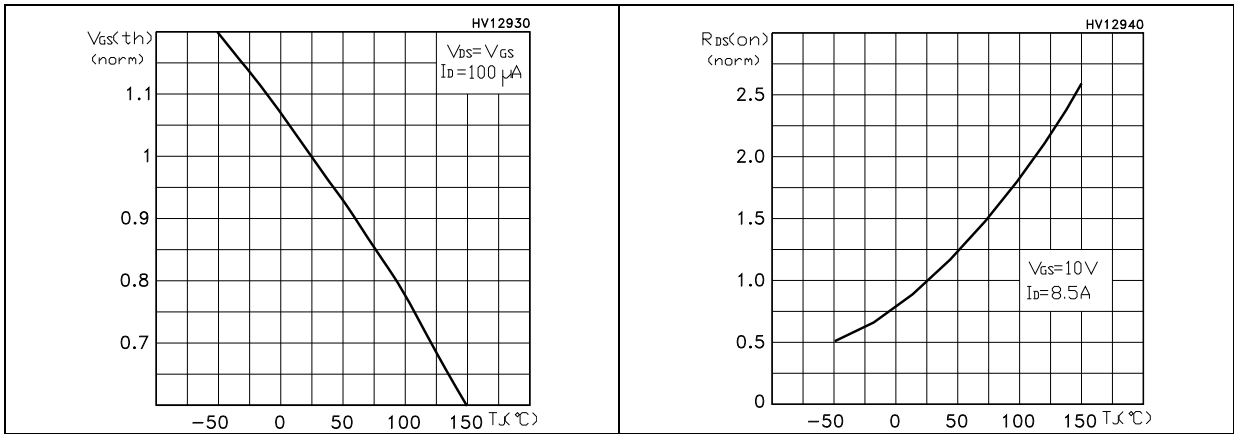
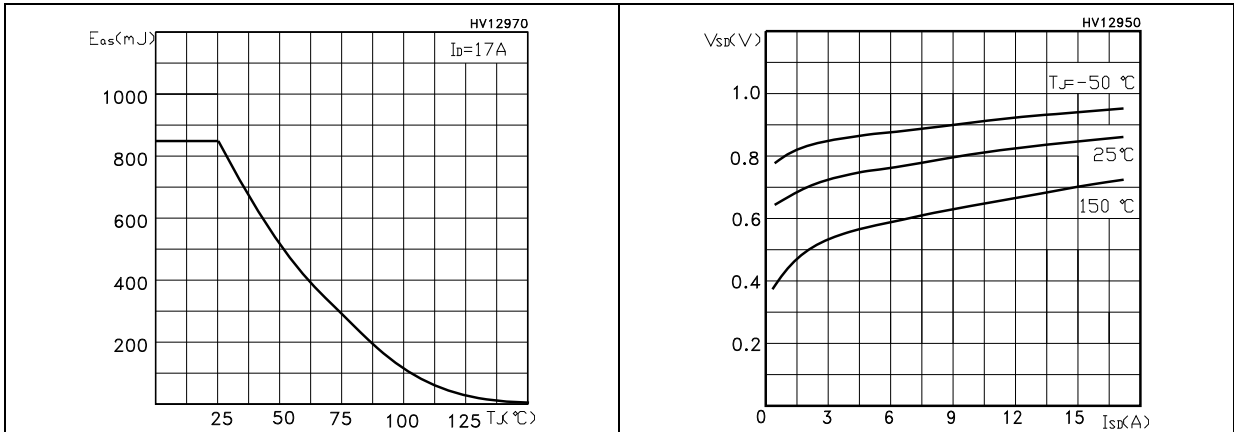

Figure 12. Maximum avalanche energy vs temperature Figure 13. Source-drain diode forward characteristic



4 Package mechanical data

In order to meet environmental requirements, ST offers these devices in different grades of ECOPACK® packages, depending on their level of environmental compliance. ECOPACK® specifications, grade definitions and product status are available at: www.st.com. ECOPACK is an ST trademark.

Table 9. TO-247 mechanical data

Dim.	mm		
	Min.	Typ.	Max.
A	4.85		5.15
A1	2.20		2.60
b	1.0		1.40
b1	2.0		2.40
b2	3.0		3.40
c	0.40		0.80
D	19.85		20.15
E	15.45		15.75
e		5.45	
L	14.20		14.80
L1	3.70		4.30
L2		18.50	
ØP	3.55		3.65
ØR	4.50		5.50
S		5.50	

Figure 20. TO-247 drawing

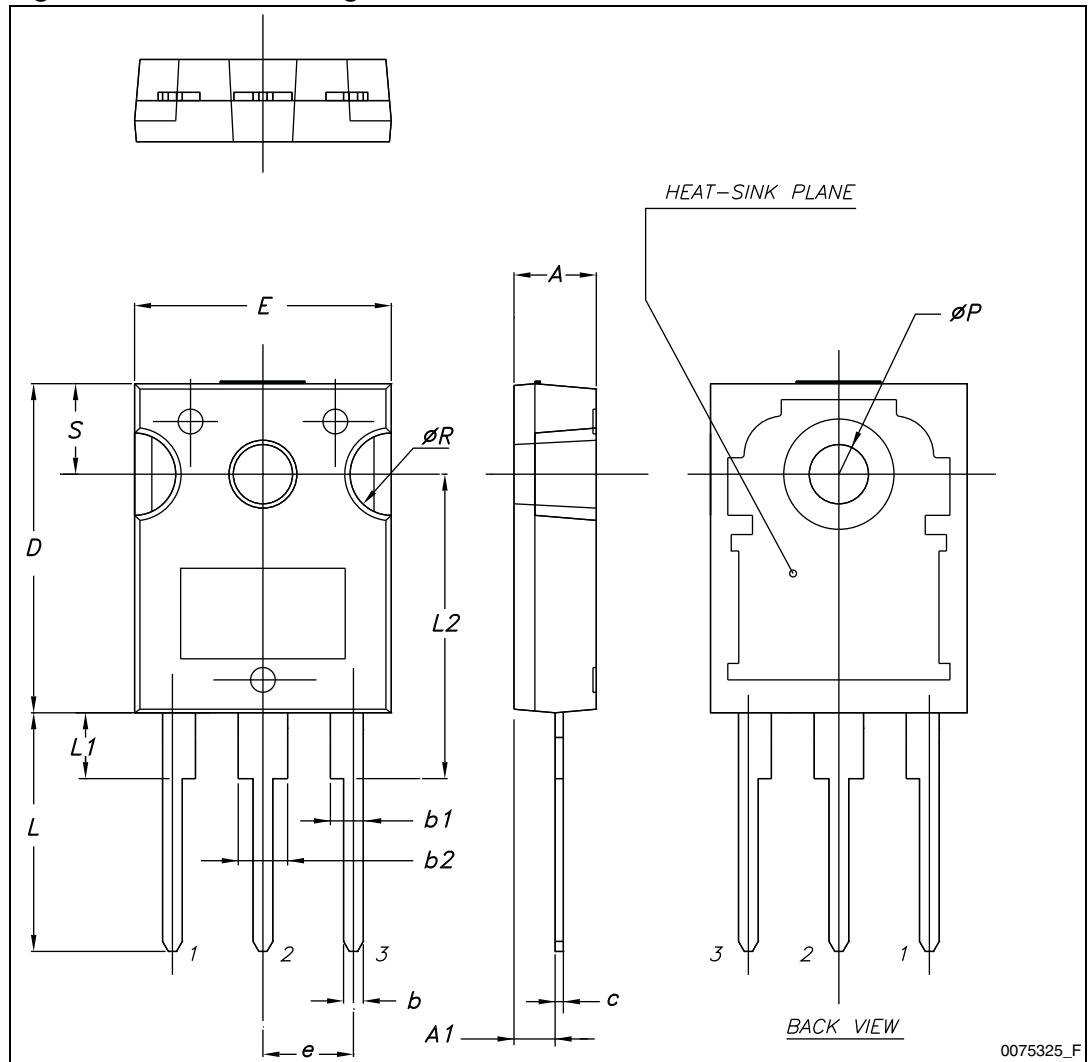

5 Revision history

Table 10. Document revision history

Date	Revision	Changes
05-Apr-2012	1	First release.

Please Read Carefully:

Information in this document is provided solely in connection with ST products. STMicroelectronics NV and its subsidiaries ("ST") reserve the right to make changes, corrections, modifications or improvements, to this document, and the products and services described herein at any time, without notice.

All ST products are sold pursuant to ST's terms and conditions of sale.

Purchasers are solely responsible for the choice, selection and use of the ST products and services described herein, and ST assumes no liability whatsoever relating to the choice, selection or use of the ST products and services described herein.

No license, express or implied, by estoppel or otherwise, to any intellectual property rights is granted under this document. If any part of this document refers to any third party products or services it shall not be deemed a license grant by ST for the use of such third party products or services, or any intellectual property contained therein or considered as a warranty covering the use in any manner whatsoever of such third party products or services or any intellectual property contained therein.

UNLESS OTHERWISE SET FORTH IN ST'S TERMS AND CONDITIONS OF SALE ST DISCLAIMS ANY EXPRESS OR IMPLIED WARRANTY WITH RESPECT TO THE USE AND/OR SALE OF ST PRODUCTS INCLUDING WITHOUT LIMITATION IMPLIED WARRANTIES OF MERCHANTABILITY, FITNESS FOR A PARTICULAR PURPOSE (AND THEIR EQUIVALENTS UNDER THE LAWS OF ANY JURISDICTION), OR INFRINGEMENT OF ANY PATENT, COPYRIGHT OR OTHER INTELLECTUAL PROPERTY RIGHT.

UNLESS EXPRESSLY APPROVED IN WRITING BY TWO AUTHORIZED ST REPRESENTATIVES, ST PRODUCTS ARE NOT RECOMMENDED, AUTHORIZED OR WARRANTED FOR USE IN MILITARY, AIR CRAFT, SPACE, LIFE SAVING, OR LIFE SUSTAINING APPLICATIONS, NOR IN PRODUCTS OR SYSTEMS WHERE FAILURE OR MALFUNCTION MAY RESULT IN PERSONAL INJURY, DEATH, OR SEVERE PROPERTY OR ENVIRONMENTAL DAMAGE. ST PRODUCTS WHICH ARE NOT SPECIFIED AS "AUTOMOTIVE GRADE" MAY ONLY BE USED IN AUTOMOTIVE APPLICATIONS AT USER'S OWN RISK.

Resale of ST products with provisions different from the statements and/or technical features set forth in this document shall immediately void any warranty granted by ST for the ST product or service described herein and shall not create or extend in any manner whatsoever, any liability of ST.

ST and the ST logo are trademarks or registered trademarks of ST in various countries.

Information in this document supersedes and replaces all information previously supplied.

The ST logo is a registered trademark of STMicroelectronics. All other names are the property of their respective owners.

© 2012 STMicroelectronics - All rights reserved

STMicroelectronics group of companies

Australia - Belgium - Brazil - Canada - China - Czech Republic - Finland - France - Germany - Hong Kong - India - Israel - Italy - Japan - Malaysia - Malta - Morocco - Philippines - Singapore - Spain - Sweden - Switzerland - United Kingdom - United States of America

www.st.com