



TAOGLAS®



Datasheet

9-in-1 GuardianX

Part No:
MA9929.A.001

Description:

Guardian X 9-in-1 Combination Adhesive Mount Antenna
1*Active GNSS, 4*5G/4G MIMO 4*Dual-Band Wi-Fi MIMO

Features:

Low-profile IP67 Rated Housing

4*5G/4G MIMO 600-6000MHz

4*Wi-Fi MIMO 2.4/5.8GHz

1*GNSS - GPS-GLONASS

Cables: GNSS 5m of RG-174, 5G/4G and Wi-Fi m of TGC-200

Connectors: GNSS FAKRA Code C, 5G/4G – FAKRA Code D, Wi-Fi – FAKRA Code I

Dimensions: 360x160x20.5mm

CE Certified

RoHS & Reach Compliant



www.taoglas.com

1. Introduction	3
2. Specifications	4
3. Antenna Characteristics	10
4. Active Antenna Characteristics	24
5. Radiation Patterns	26
6. Mechanical Drawing	79
7. Packaging	80
<hr/>	
Changelog	81

Taoglas makes no warranties based on the accuracy or completeness of the contents of this document and reserves the right to make changes to specifications and product descriptions at any time without notice. Taoglas reserves all rights to this document and the information contained herein. Reproduction, use or disclosure to third parties without express permission is strictly prohibited.



1. Introduction

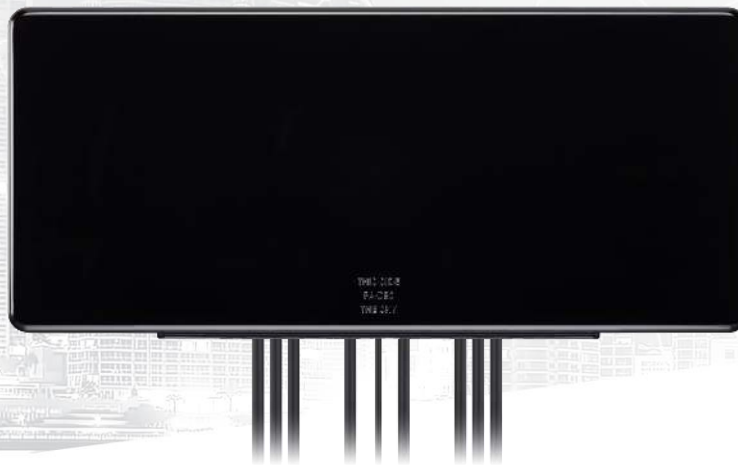

The Taoglas MA9929 Guardian X has been designed to combine a high number of antenna combinations in one enclosure. The MA9929 is a 9-in-1 combination antenna that combines all 9 antenna elements in one low-profile heavy-duty, IP67 rated waterproof, adhesive mount external enclosure. The MA9929 comes with 1* Active GPS/GLONASS/Galileo, 4* 5G/4G Cellular MIMO (600-6000MHz), 4* Wi-Fi 6 MIMO (2.4/5.1-7.125GHz) as standard. The MA9929 has been designed as a low profile solution for IoT and Automotive applications where space is at a premium.

This is an ideal external combination antenna solution that is used where drilling a hole through the roof of a vehicle or a metal panel for an external antenna is not feasible.

The MA9929 also operates at Band 71, the newly established 5G band at 600MHz.

Typical applications include:

- Passenger Bus / Rail / Air Applications.
- Automotive and Heavy Equipment Vehicle Tracking and Telematics
- HD Video over 5G/4G
- First Responder and Emergency Services
- M2M Applications/IoT

5G/4G applications demand high-speed data uplink and downlink. High efficiency and high gain MIMO antennas are necessary to achieve the required signal to noise ratio and throughput required to solve these challenges. Taoglas also takes care to ensure high isolation between the MIMO antennas to prevent self-interference. Low loss cables are used to keep efficiency high over longer cable lengths. In contrast, smaller MIMO antennas with poorer quality thin cables will have reduced efficiency and isolation, which would lead to a large drop in system throughput, increased incidences of signal drops, and may indeed not make a system connection at all.

Cable type and length, and connector types are fully customizable and the GuardianX can also be customized for any variation of antennas below 9-in-1. Contact your regional Taoglas customer support team for more information.

2. Specifications

GNSS Frequency Bands Covered							
GPS	L1	L2	L5				
	■	□	□				
GLONASS	G1	G2	G3				
	■	□	□				
Galileo	E1	E5a	E5b	E6			
	■	□	□	□			
BeiDou	B1	B2a	B2b	B3			
	□	□	□	□			
QZSS (Regional)	L1	L2C	L5	L6			
	■	□	□	□			
IRNSS (Regional)	L5						
	□						
SBAS	L1/E1/B1	L5/B2a/E5a	G1	G2	G3		
	■	□	■	□	□		

*SBAS systems: WASS(L1/L5), EGNOS(E1/E5a), SDCM(G1/G2/G3), SNAS(B1,B2a), GAGAN(L1/L5), QZSS(L1/L5), KAZZ(L1/L5).

GNSS Electrical		
Frequency (MHz)	1575.42	1602
VSWR (max.)	2.0:1	2.0:1
Efficiency (%)	67	71
Peak Gain	3	3.2
Axial Ratio (dB)	6	14
Polarization	RHCP	
Impedance	50Ω	

LNA and Filter Electrical Properties		
Frequency (MHz)	1575.42	1602
VSWR (max.)	2.0:1	2.0:1
Gain@1.8V (Typ.)	25	25
Gain@3.0V (Typ.)	31	31
Gain@5.5V (Typ.)	34	34
Noise@1.8V (Typ.)	3	3
Noise@3.0V (Typ.)	3	3
Noise@5.5V (Typ.)	3.3	3.3
Power consumption@1.8V (Typ.)	5	
Power consumption@3.0V (Typ.)	10	
Power consumption@5.5V (Typ.)	23	
Total Specification (Through Antenna, SAW Filter and LNA)		
Frequency (MHz)	1575.42	1602
Gain@3V (dBi)	31 ± 3	30 ± 3
Output Impedance	50 Ω	

5G/4G MIMO Antennas											
Frequency (MHz)	5G Band 71	LTE700	GSM800 900	5G NR 74	5G NR N66	LTE2600	5G NR N77	5G NR N78	5G NR N79	LTE5200	
	617-698	698-824	824-960	1427-1518	1710-2200	2300-2690	3300-4200	3300-3800	4400-5000	5150-5925	
Efficiency (%)											
LTE1	5.0m	36.0	40.1	34.1	38.3	33.2	29.2	21.3	21.0	23.2	16.0
LTE2	5.0m	22.7	25.9	26.7	12.2	25.5	21.7	18.4	18.8	11.6	9.0
LTE3	5.0m	24.4	26.1	26.4	27.4	25.5	25.0	20.5	20.8	17.1	9.3
LTE4	5.0m	13.5	25.9	26.6	30.4	25.3	23.9	18.1	18.4	12.1	9.4
Average Gain (dB)											
LTE1	5.0m	-4.43	-3.96	-4.67	-4.17	-4.79	-5.34	-6.72	-6.78	-6.35	-7.97
LTE2	5.0m	-6.43	-5.86	-5.74	-9.13	-5.93	-6.63	-7.35	-7.26	-9.37	-10.45
LTE3	5.0m	-6.13	-5.83	-5.78	-5.63	-5.94	-6.02	-6.88	-6.83	-7.68	-10.30
LTE4	5.0m	-8.69	-5.87	-5.75	-5.17	-5.97	-6.22	-7.43	-7.34	-9.16	-10.27
Peak Gain (dBi)											
LTE1	5.0m	2.22	2.24	-0.11	3.18	2.71	1.89	0.67	0.67	0.52	-0.02
LTE2	5.0m	0.09	0.17	1.46	-2.68	0.56	-0.02	-0.03	-0.03	-1.70	-3.23
LTE3	5.0m	1.64	1.65	1.41	0.39	1.89	1.96	0.86	0.86	-1.14	-1.99
LTE4	5.0m	-1.52	0.07	0.02	1.69	1.46	1.86	0.96	0.96	-1.68	-2.66
Impedance	50 Ω										
Polarization	Linear										
Radiation Pattern	Omni										
Max. input power	20W										

Wi-Fi MIMO							
Frequency (MHz)		2.4GHz	5GHz	6.175GHz	6.475GHz	6.7GHz	7GHz
		2400-2500	5150-5850	5925-6425	6425-6525	6525-6875	6875-7125
Efficiency (%)							
WiFi1	5.0m	25.0	19.8	16.3	15.2	15.2	13.3
WiFi2	5.0m	23.8	19.9	17.2	14.9	14.5	12.7
WiFi3	5.0m	21.8	23.7	17.7	15.9	15.4	14.8
WiFi4	5.0m	28.5	24.2	17.8	14.6	14.4	13.3
Average Gain (dB)							
WiFi1	5.0m	-6.02	-7.02	-7.87	-8.18	-8.20	-8.78
WiFi2	5.0m	-6.23	-7.02	-7.64	-8.26	-8.39	-8.95
WiFi3	5.0m	-6.62	-6.26	-7.53	-7.98	-8.14	-8.29
WiFi4	5.0m	-5.45	-6.16	-7.50	-8.34	-8.41	-8.77
Peak Gain (dBi)							
WiFi1	5.0m	-0.28	0.10	-0.96	-2.45	-1.78	-2.85
WiFi2	5.0m	0.21	-0.51	-1.03	-1.91	-1.65	-2.83
WiFi3	5.0m	0.37	2.29	-0.24	-0.24	-1.52	-1.99
WiFi4	5.0m	2.72	2.45	-0.77	-2.37	-1.78	-1.42

Mechanical	
Height without Bracket	20.5mm
Planner Dimension	360x160mm
Bracket Dimensions	∅77x6.3mm
Housing Material	PC
Adhesive	CR4305 + 3M 9448HK
Cable	5m TGC200 for 5G/4G – Fully Customizable 5m TGC200 for Wi-Fi – Fully Customizable 5m RG174 for GNSS – Fully Customizable
Connector	5G/4G: FAKRA Code D Bordeaux Violet – Fully Customizable Wi-Fi: FAKRA Code I Beige – Fully Customizable GNSS: FAKRA Code C Blue – Fully Customizable
Weight	1068 g
Environmental	
Protection	IP67
Temperature Range	-40°C to 85°C
Humidity	Non-condensing 65°C 95% RH

5G/4G Bands			
Band Number	5GNR / FR1 / LTE / LTE-Advanced / WCDMA / HSPA / HSPA+ / TD-SCDMA		
	Uplink	Downlink	Covered
1	UL: 1920 to 1980	DL: 2110 to 2170	✓
2	UL: 1850 to 1910	DL: 1930 to 1990	✓
3	UL: 1710 to 1785	DL: 1805 to 1880	✓
4	UL: 1710 to 1755	DL: 2110 to 2155	✓
5	UL: 824 to 849	DL: 869 to 894	✓
7	UL: 2500 to 2570	DL: 2620 to 2690	✓
8	UL: 880 to 915	DL: 925 to 960	✓
9	UL: 1749.9 to 1784.9	DL: 1844.9 to 1879.9	✓
11	UL: 1427.9 to 1447.9	DL: 1475.9 to 1495.9	✓
12	UL: 699 to 716	DL: 729 to 746	✓
13	UL: 777 to 787	DL: 746 to 756	✓
14	UL: 788 to 798	DL: 758 to 768	✓
17	UL: 704 to 716	DL: 734 to 746	✓
18	UL: 815 to 830	DL: 860 to 875	✓
19	UL: 830 to 845	DL: 875 to 890	✓
20	UL: 832 to 862	DL: 791 to 821	✓
21	UL: 1447.9 to 1462.9	DL: 1495.9 to 1510.9	✓
22	UL: 3410 to 3490	DL: 3510 to 3590	✓
23	UL: 2000 to 2020	DL: 2180 to 2200	✓
24	UL: 1625.5 to 1660.5	DL: 1525 to 1559	✓
25	UL: 1850 to 1915	DL: 1930 to 1995	✓
26	UL: 814 to 849	DL: 859 to 894	✓
27	UL: 807 to 824	DL: 852 to 869	✓
28	UL: 703 to 748	DL: 758 to 803	✓
29	UL: -	DL: 717 to 728	✓
30	UL: 2305 to 2315	DL: 2350 to 2360	✓
31	UL: 452.5 to 457.5	DL: 462.5 to 467.5	✗
32	UL: -	DL: 1452 - 1496	✓
35		1850 to 1910	✓
38		2570 to 2620	✓
39		1880 to 1920	✓
40		2300 to 2400	✓
41		2496 to 2690	✓
42		3400 to 3600	✓
43		3600 to 3800	✓
48		3550 to 3700	✓
66	UL: 1710-1780	DL: 2110-2200	✓
71		617 to 698	✓
74/75/76		1427 to 1518	✓
78		3300 to 3800	✓
79		4400 to 5000	✓

3. Antenna Characteristics

3.1 Return Loss - GNSS

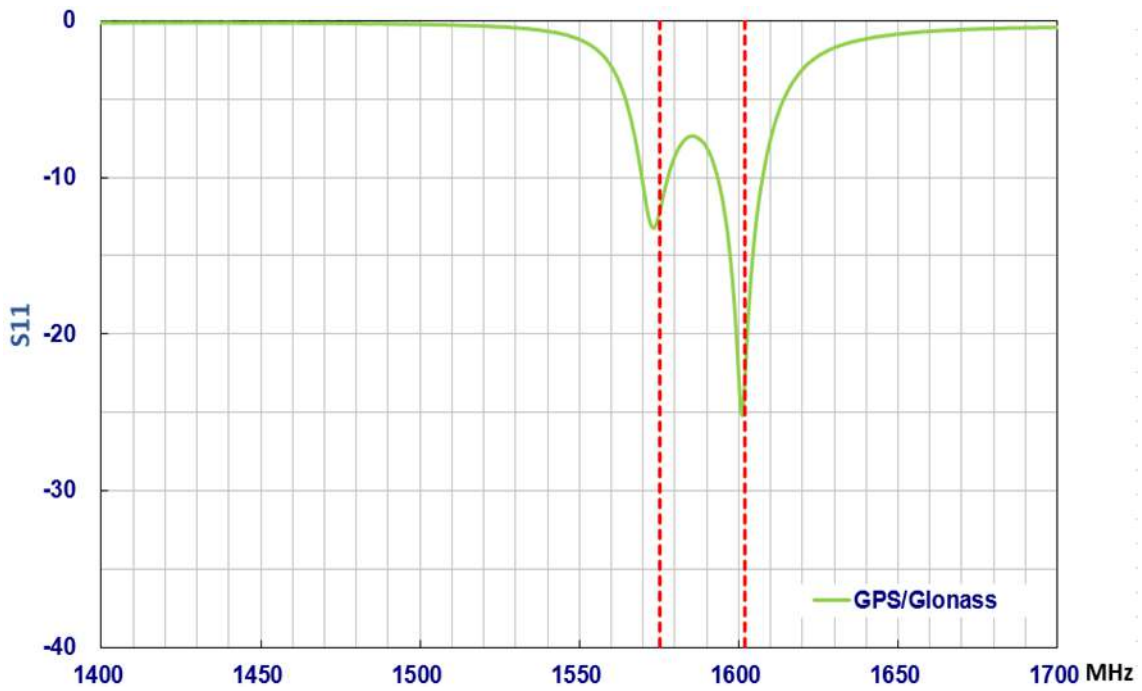

3.2 Efficiency - GNSS

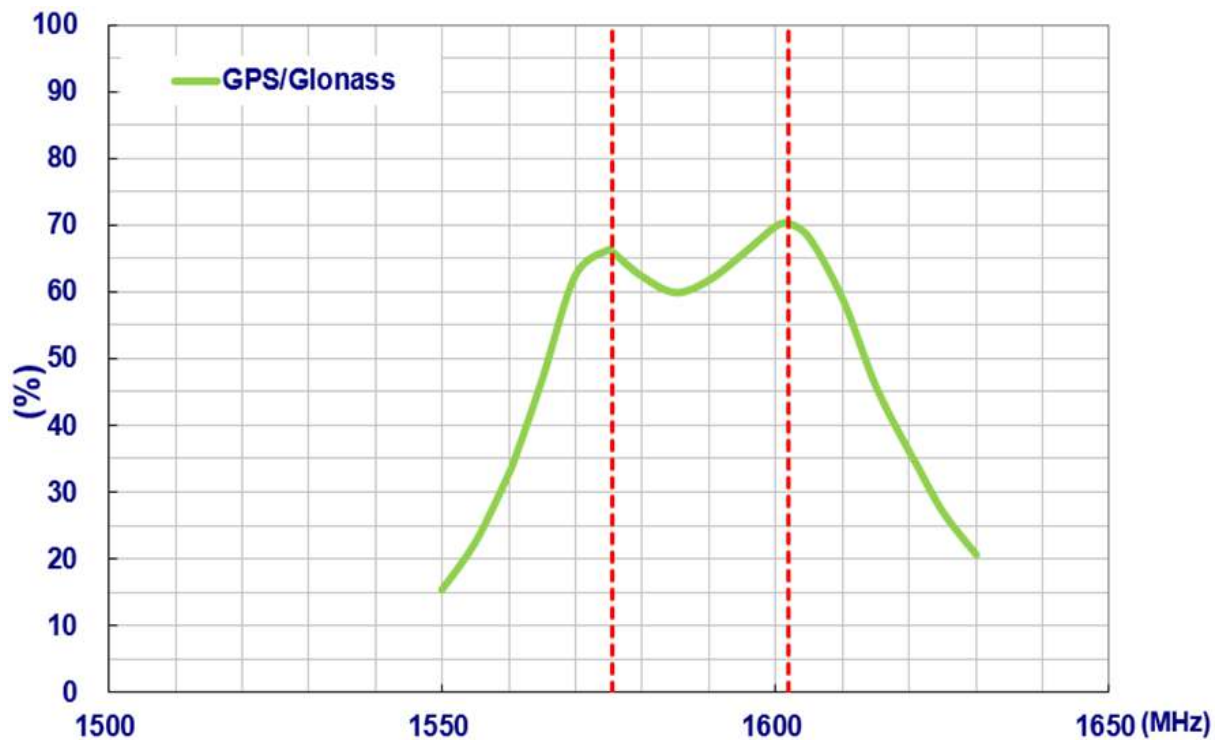

3.3 Average Gain - GNSS

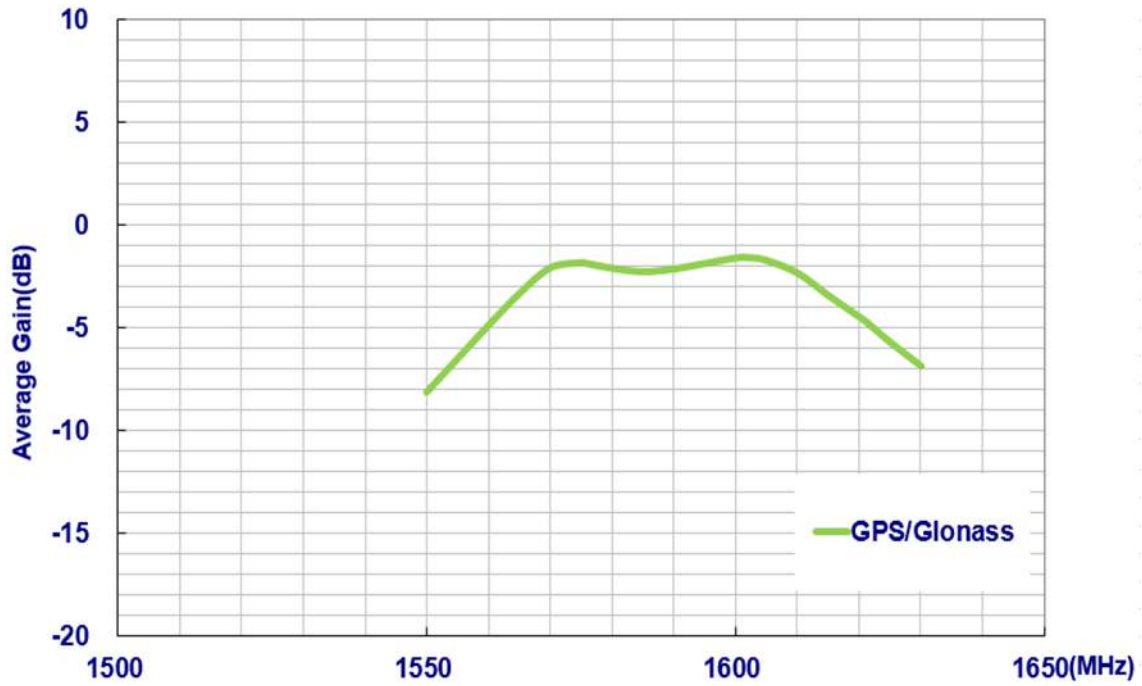

3.4 Peak Gain - GNSS

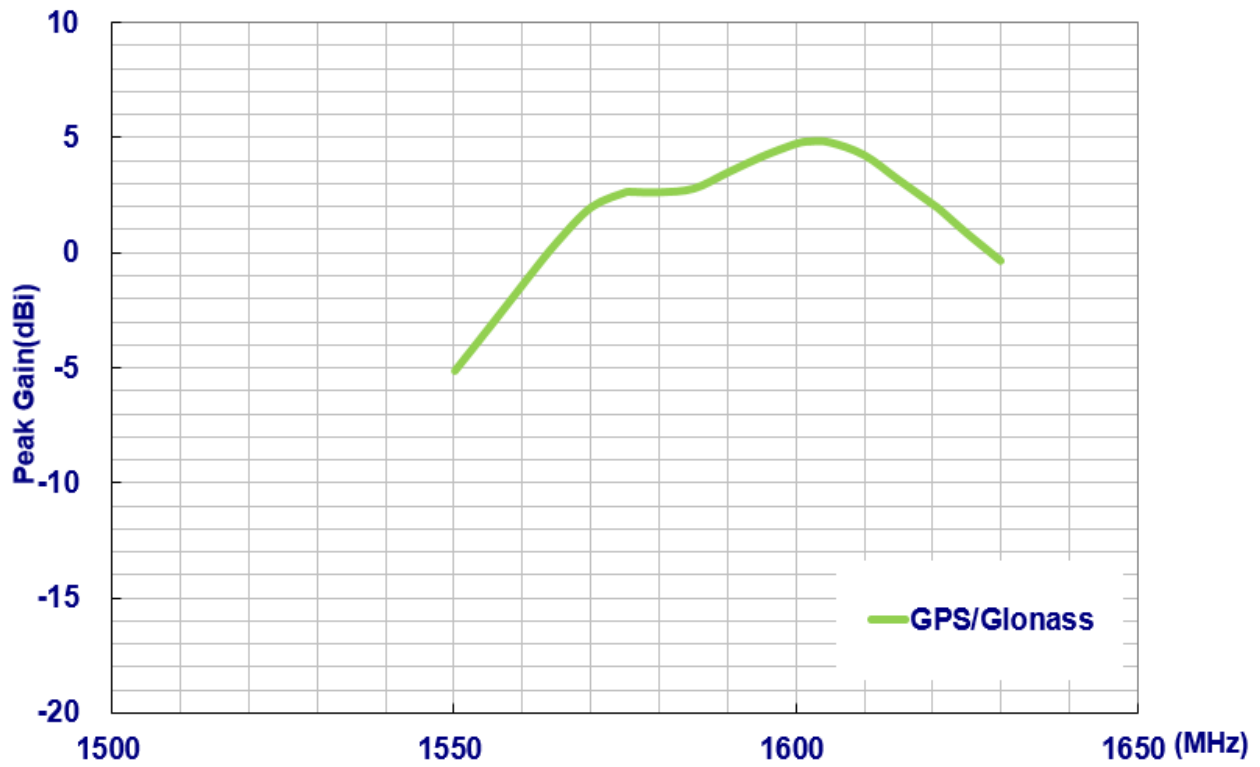

3.5 Efficiency – 5G/4G MIMO 1

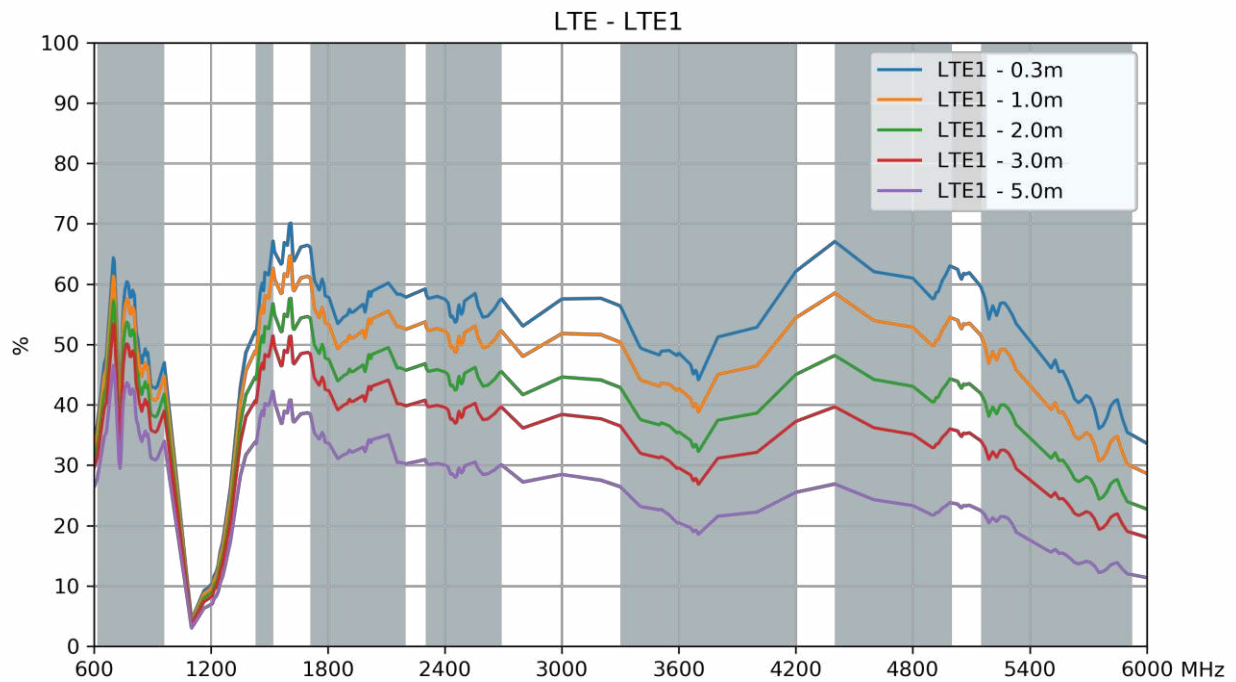

3.6 Efficiency – 5G/4G MIMO 2

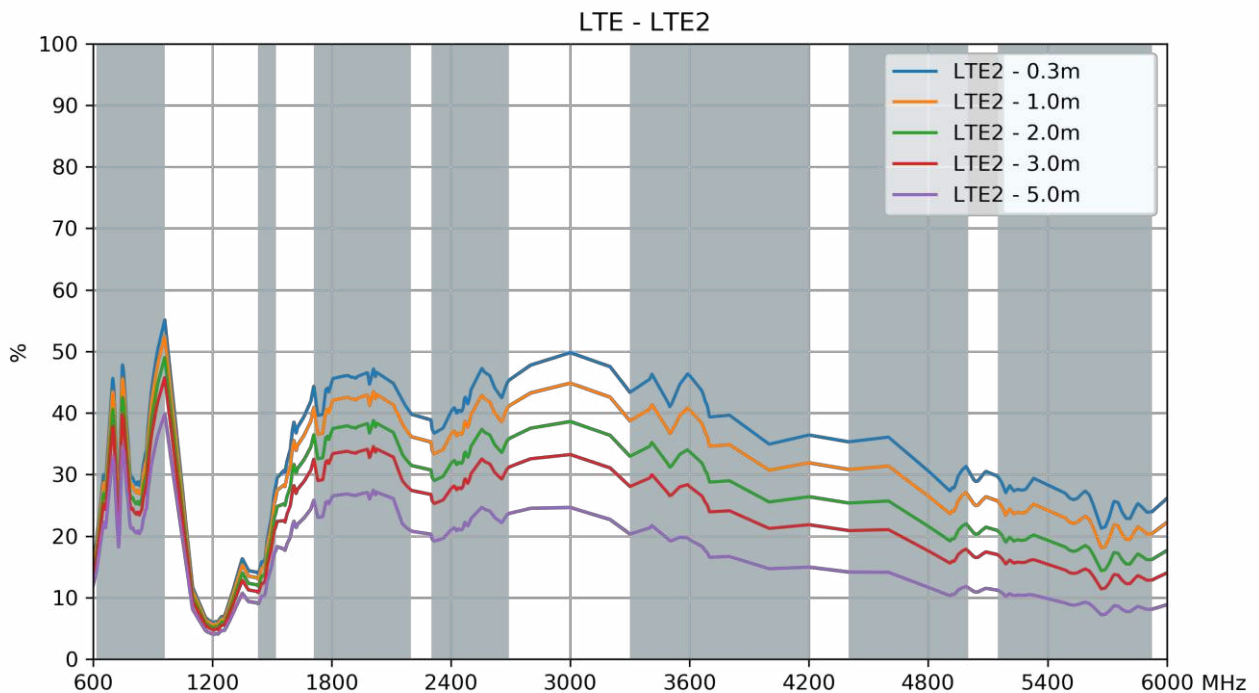

3.7 Efficiency – 5G/4G MIMO 3

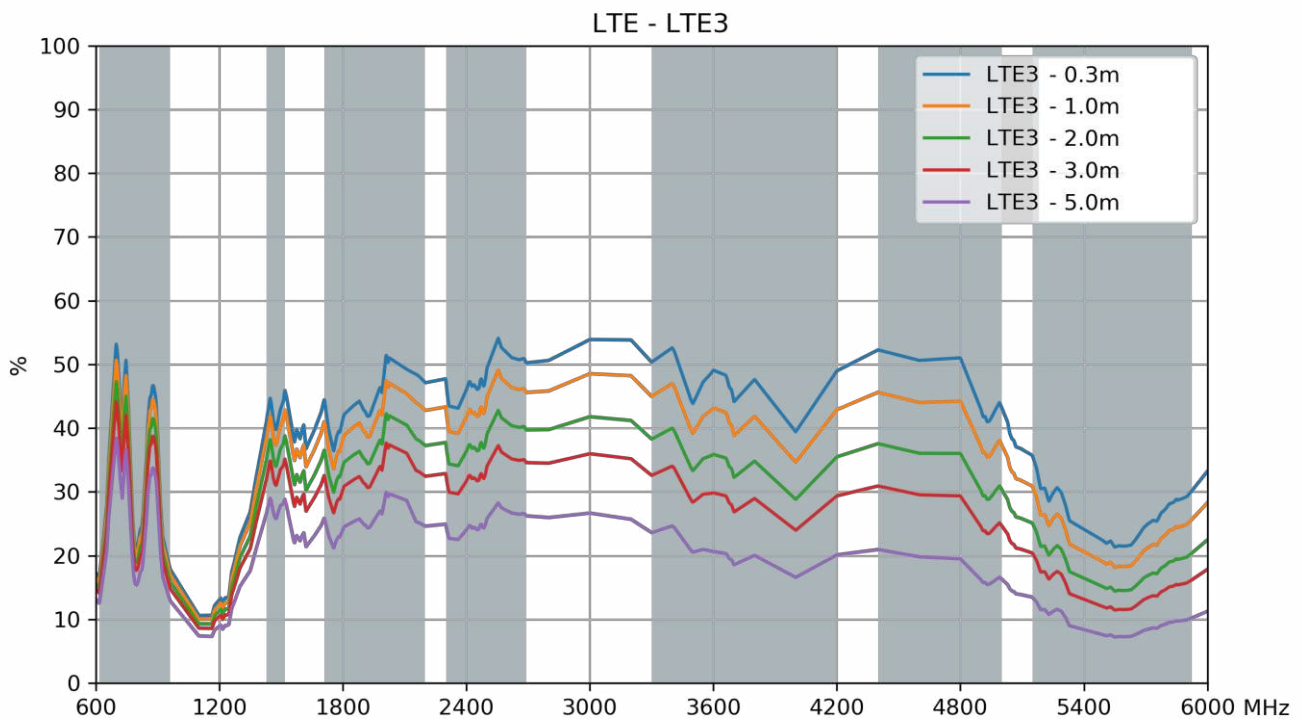

3.8 Efficiency – 5G/4G MIMO 4

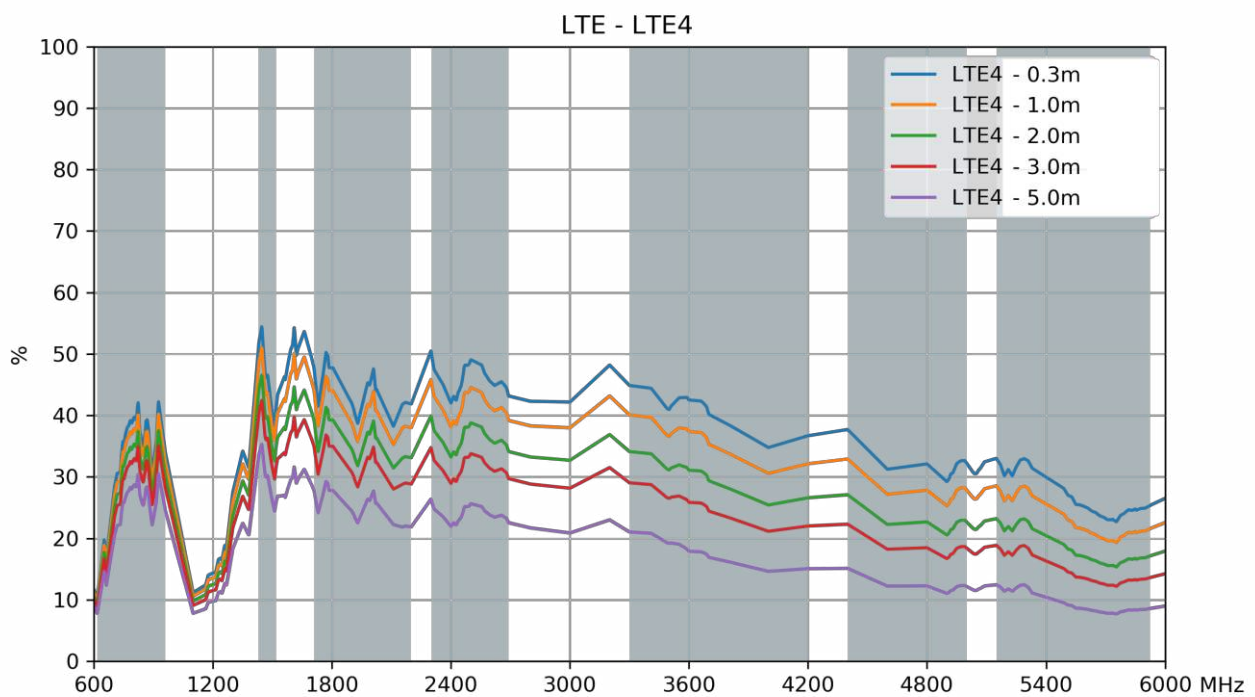

3.9 Efficiency – Wi-Fi MIMO 1

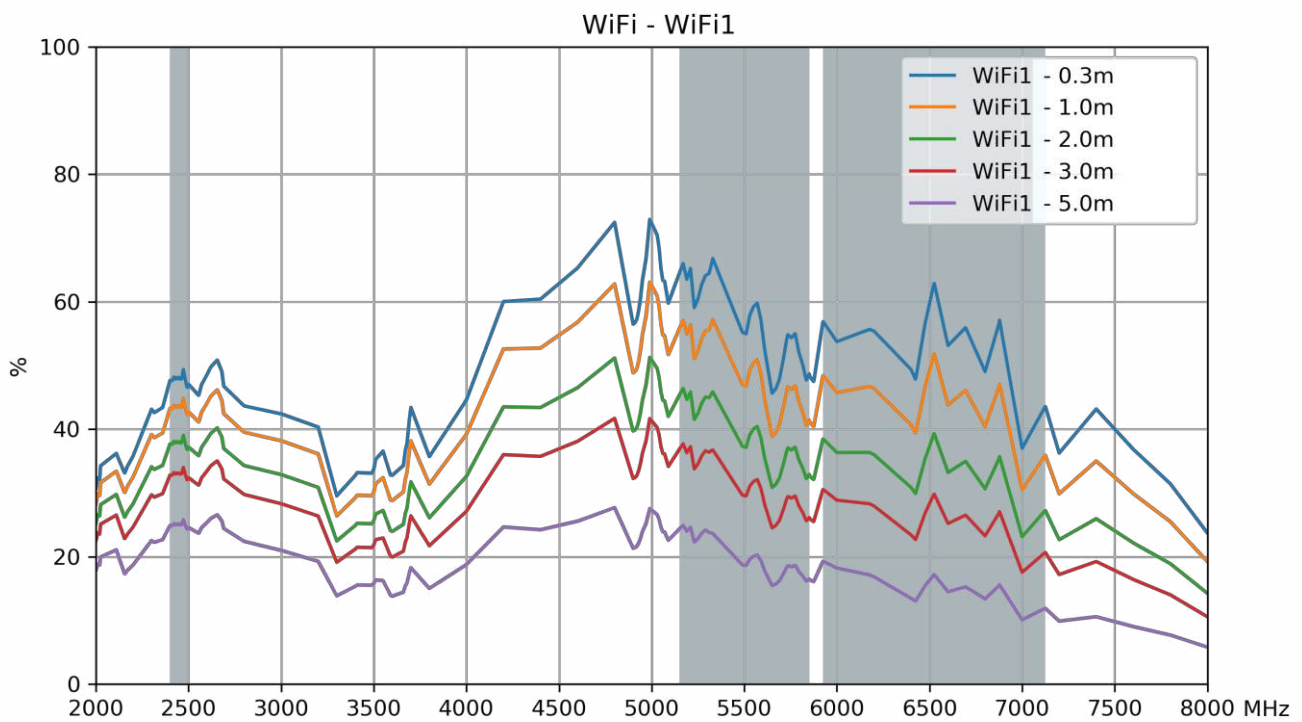

3.10 Efficiency – Wi-Fi MIMO 2

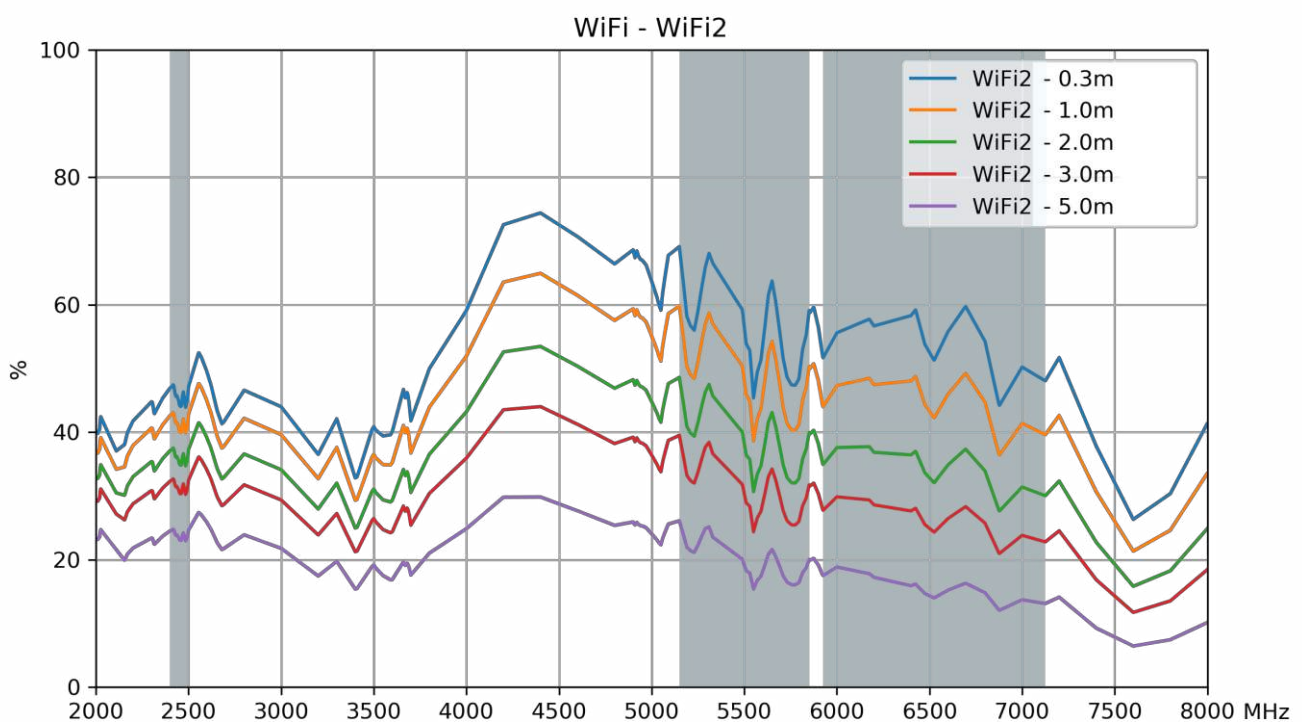

3.11 Efficiency – Wi-Fi MIMO 3

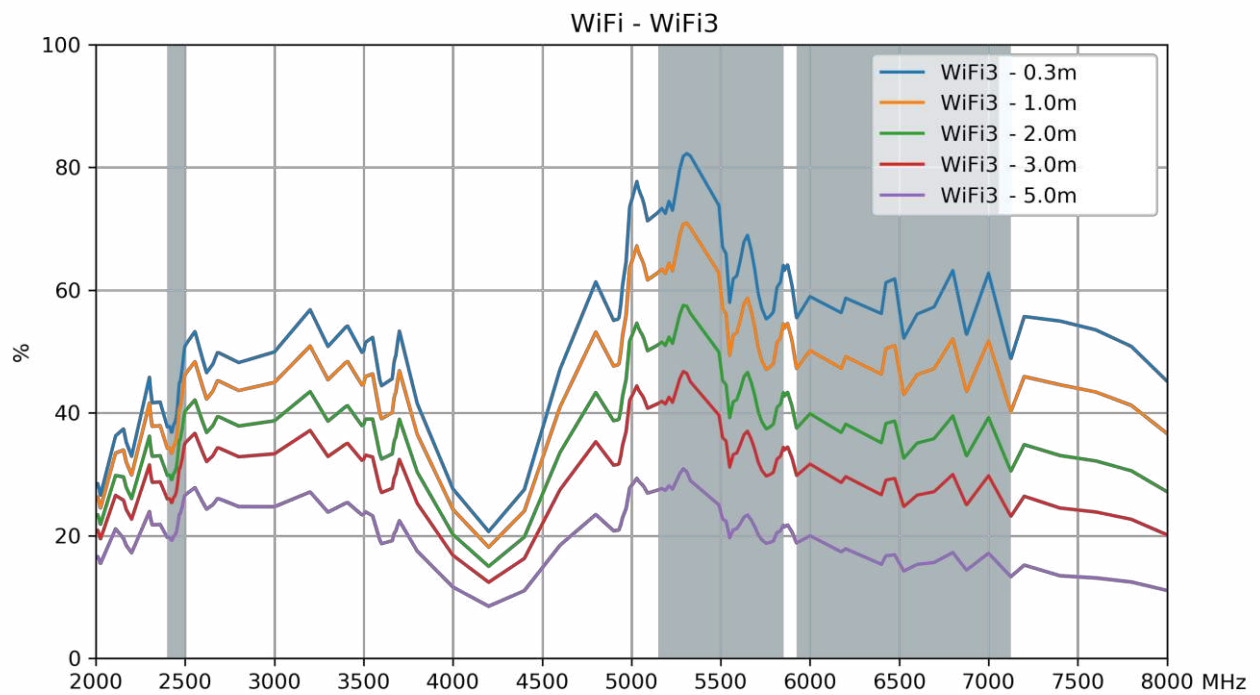

3.12 Efficiency – Wi-Fi MIMO 4

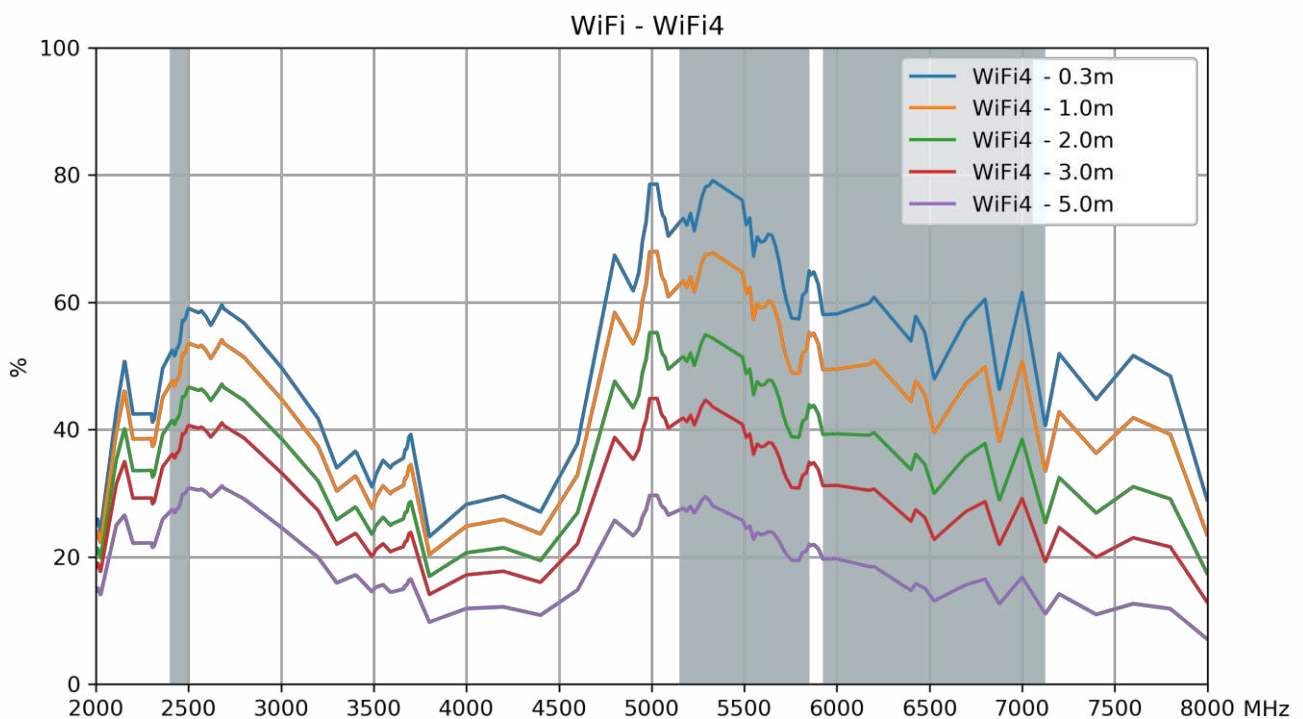

3.13 Average Gain – 5G/4G MIMO 1

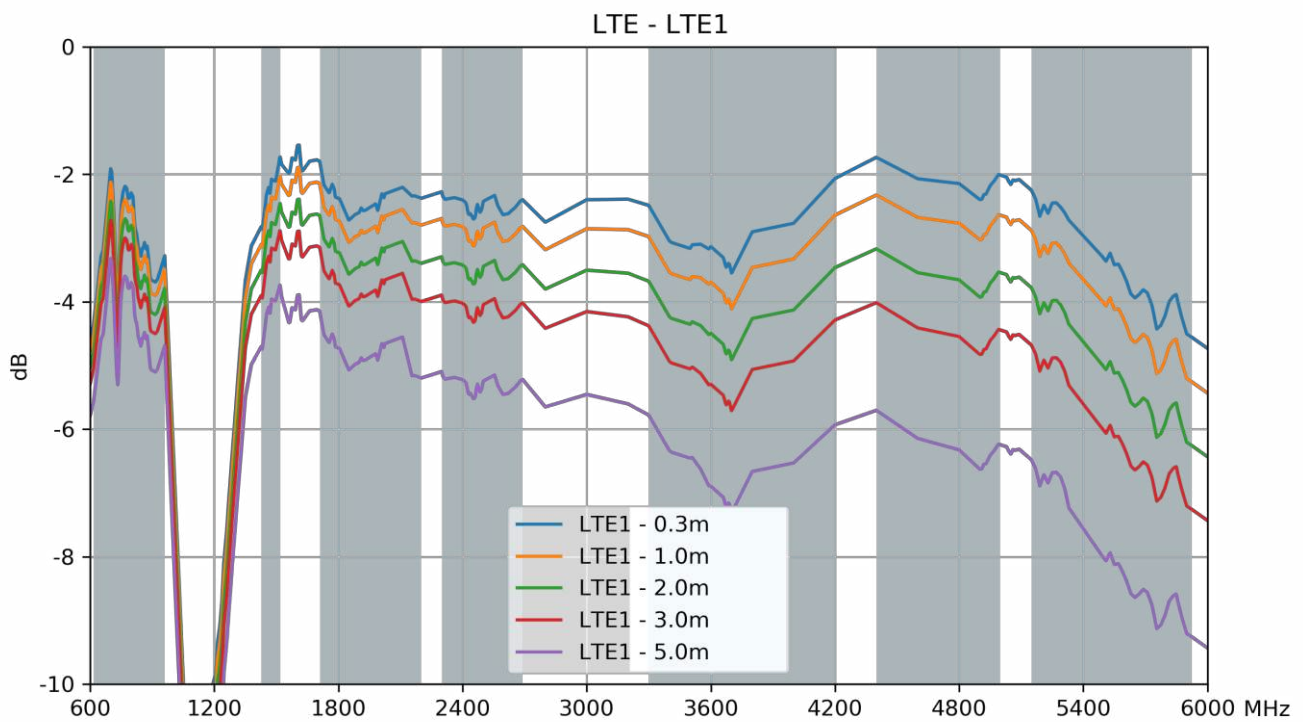

3.14 Average Gain – 5G/4G MIMO 2

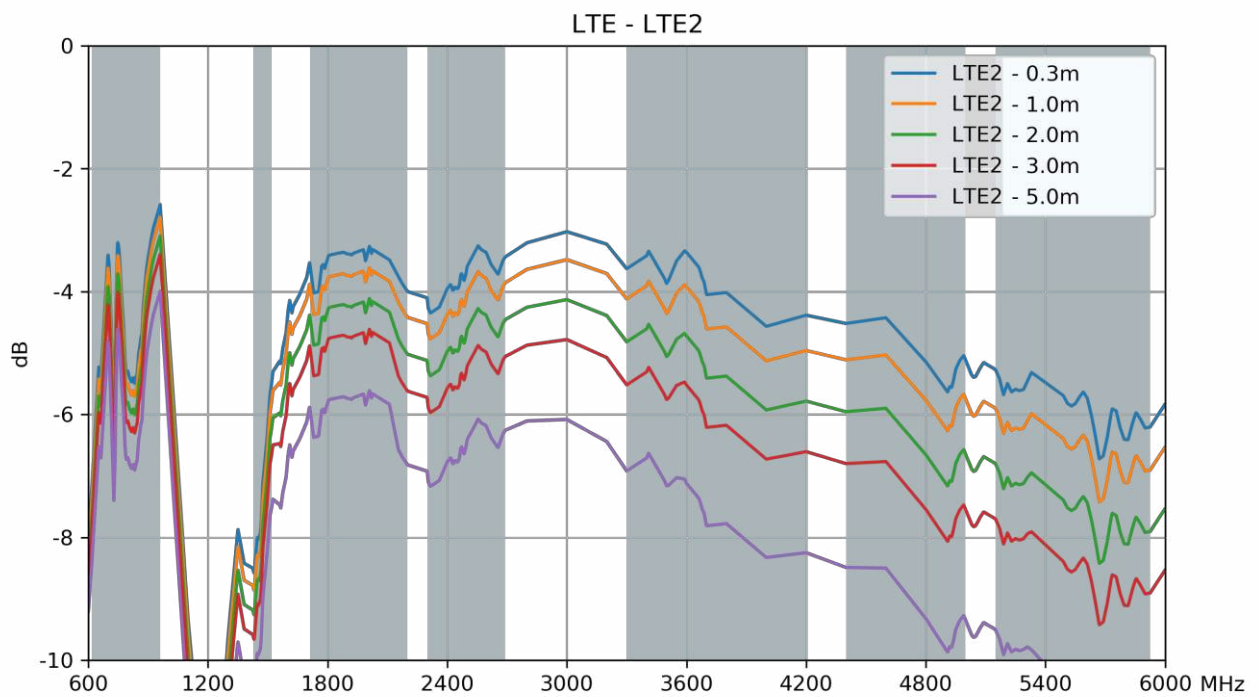

3.15 Average Gain – 5G/4G MIMO 3

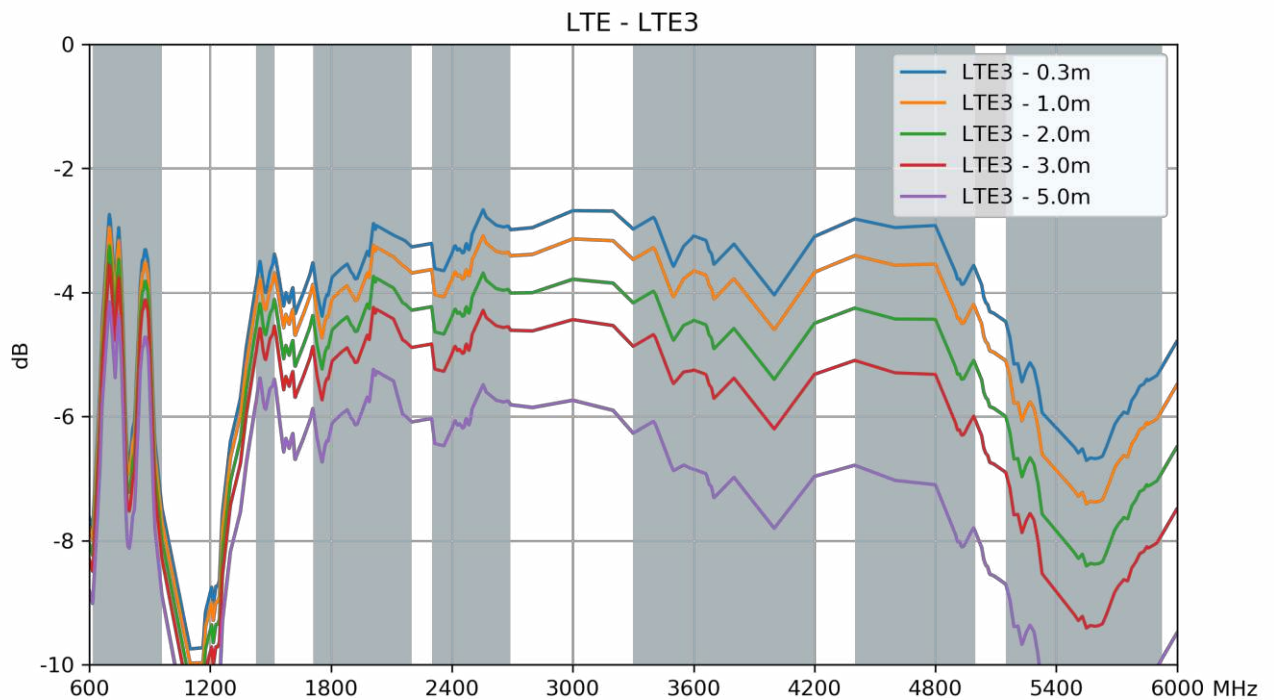

3.16 Average Gain – 5G/4G MIMO 4

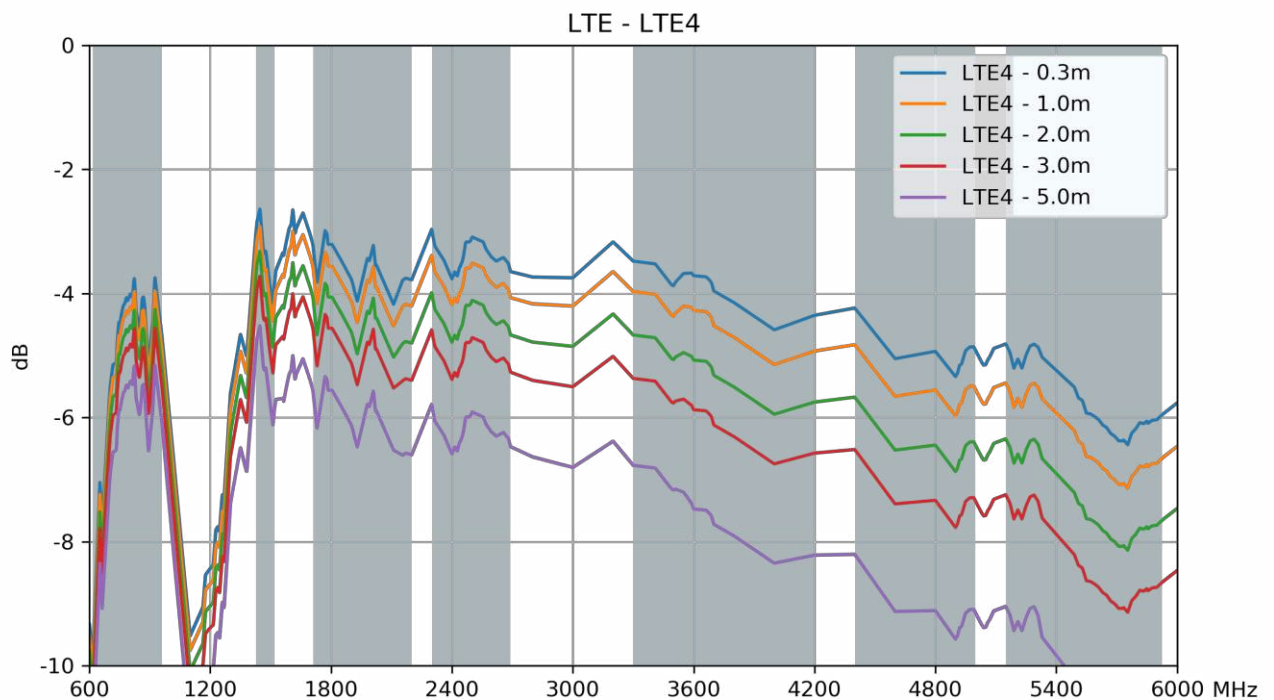

3.17 Average Gain – Wi-Fi MIMO 1

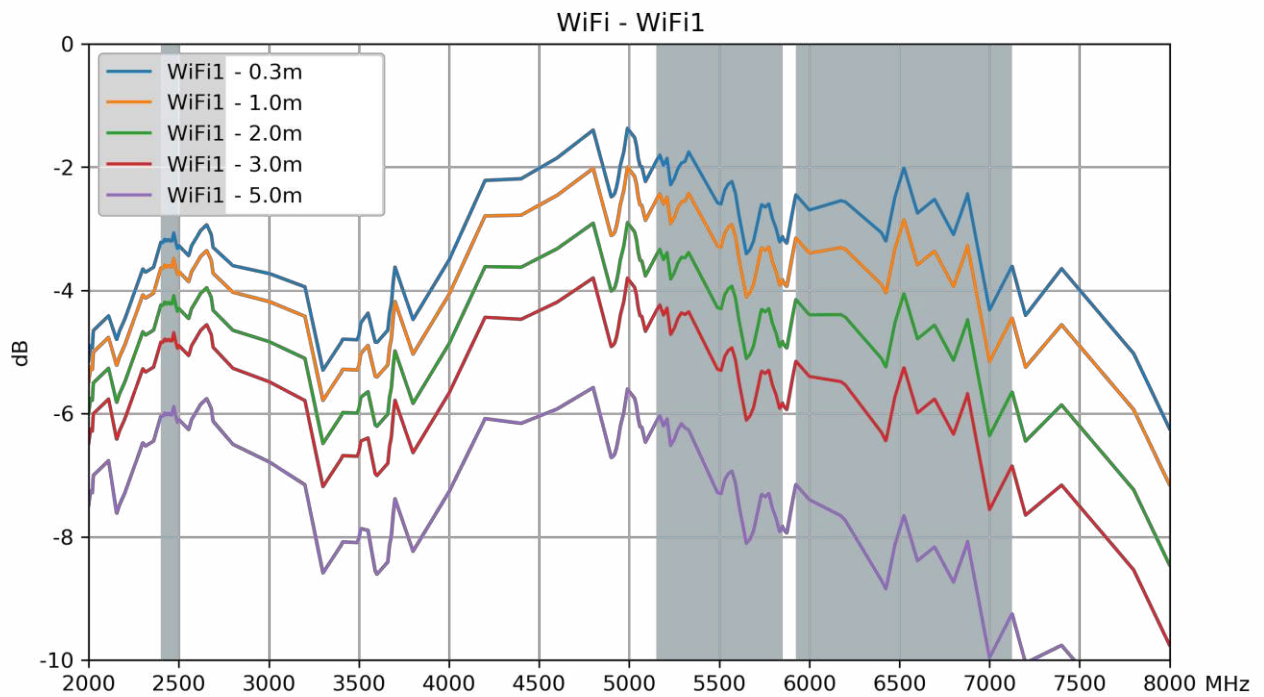

3.18 Average Gain – Wi-Fi MIMO 2

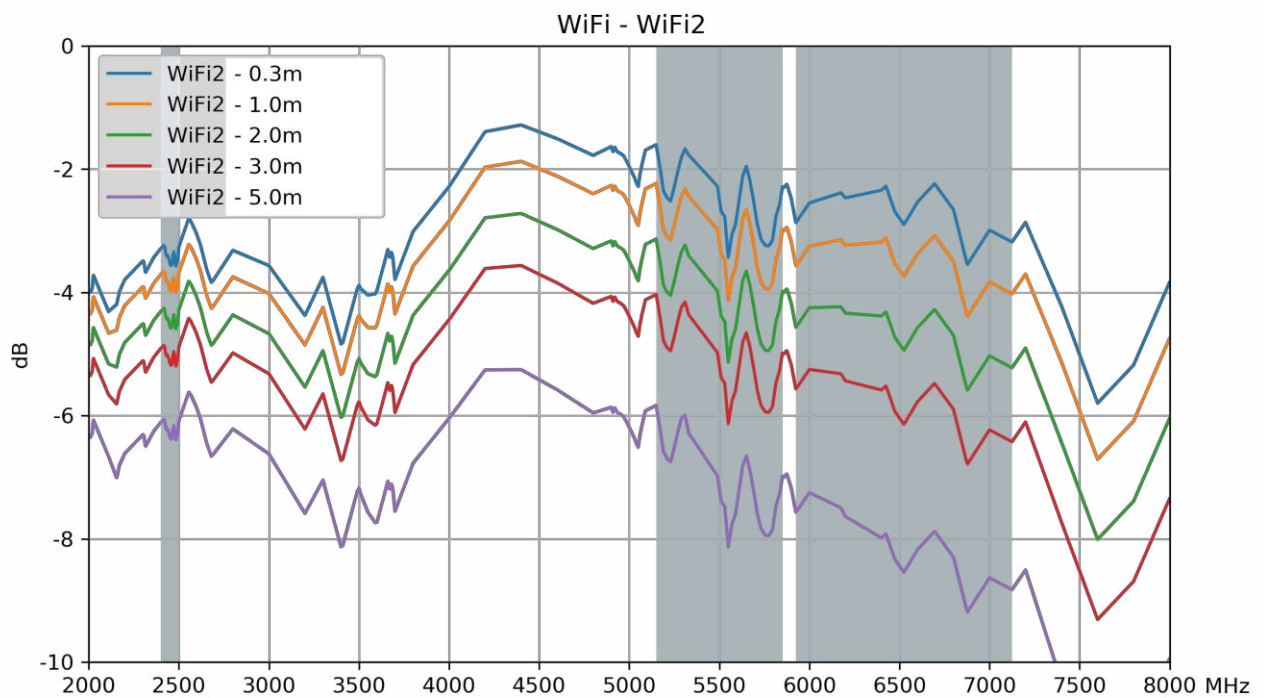

3.19 Average Gain – 5G/4G MIMO 3

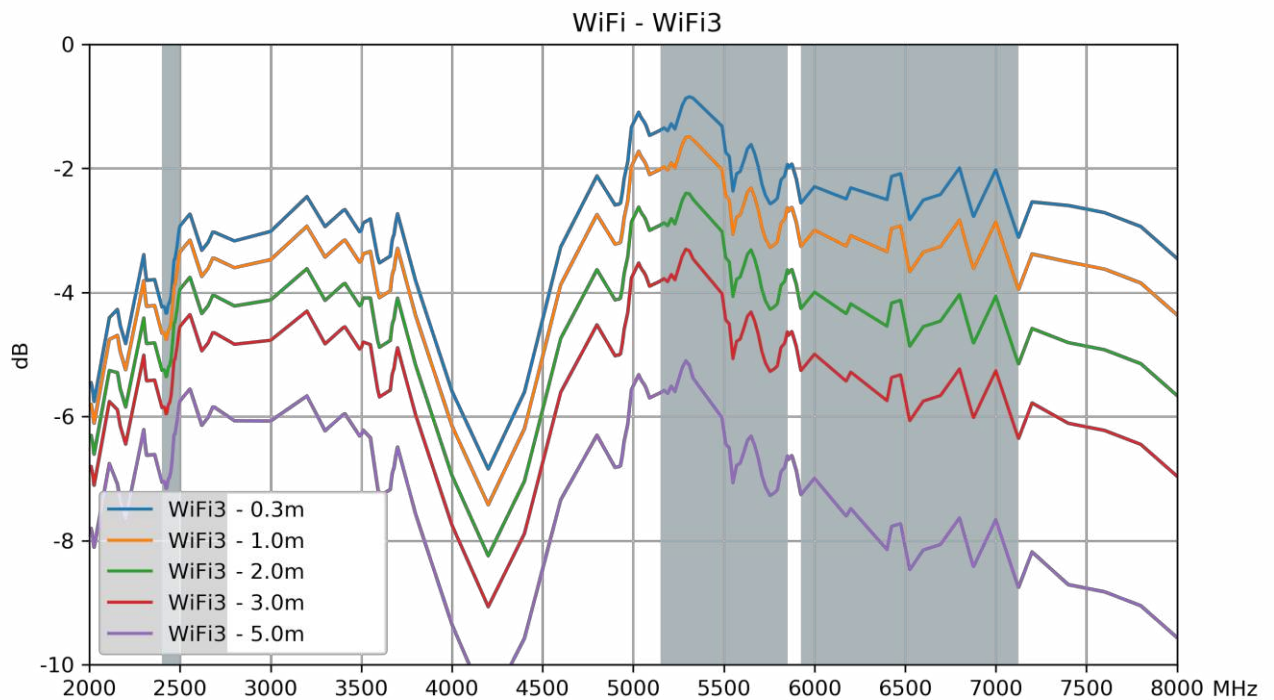

3.20 Average Gain – 5G/4G MIMO 4

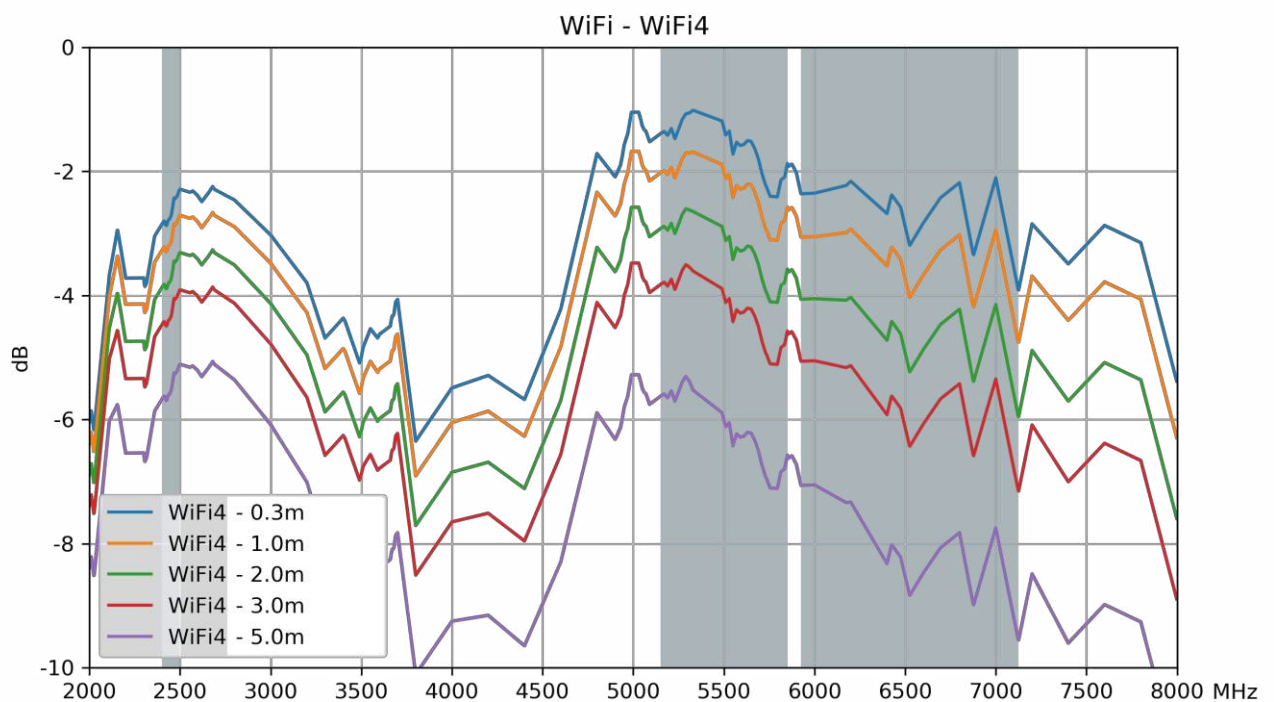

3.21 Peak Gain – 5G/4G MIMO 1

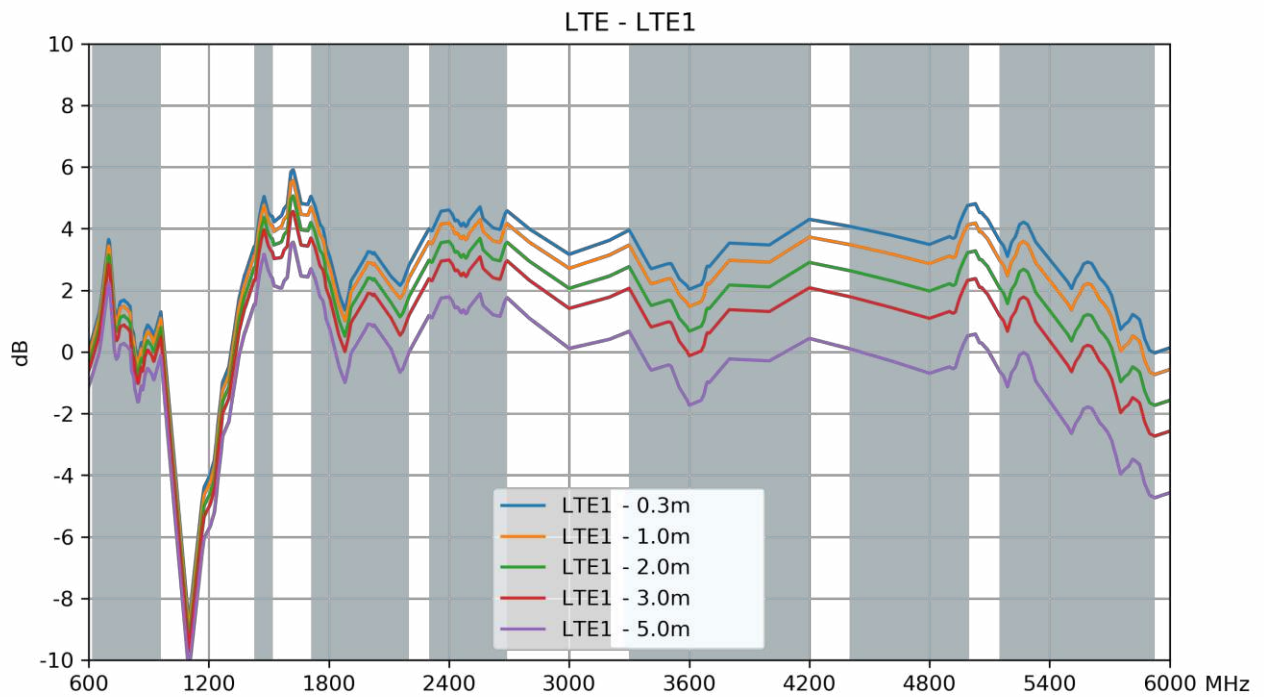

3.22 Peak Gain – 5G/4G MIMO 2

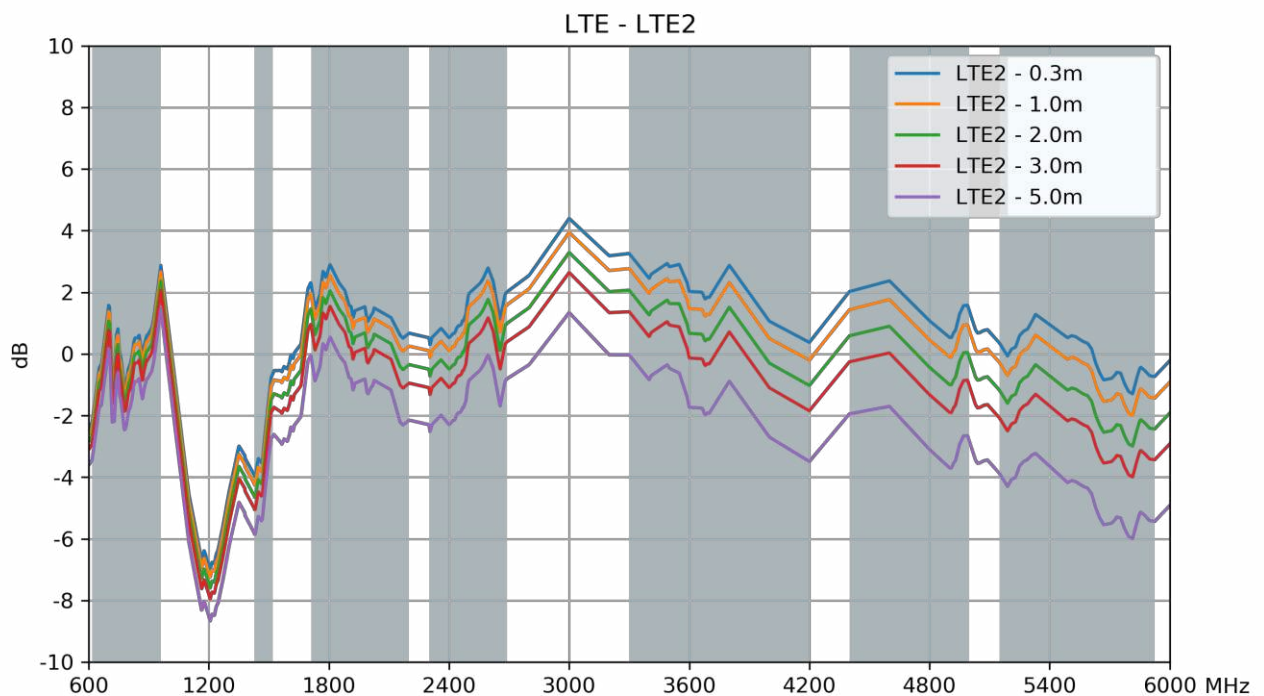

3.23 Peak Gain – 5G/4G MIMO 3

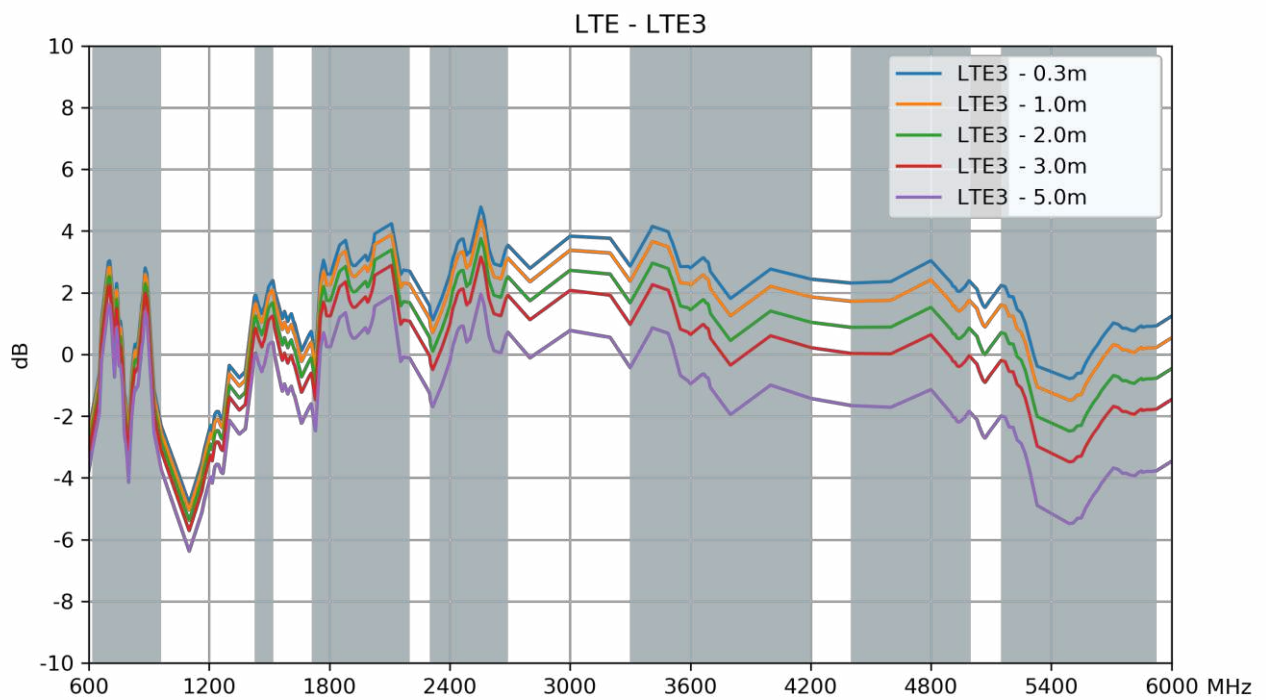

3.24 Peak Gain – 5G/4G MIMO 4

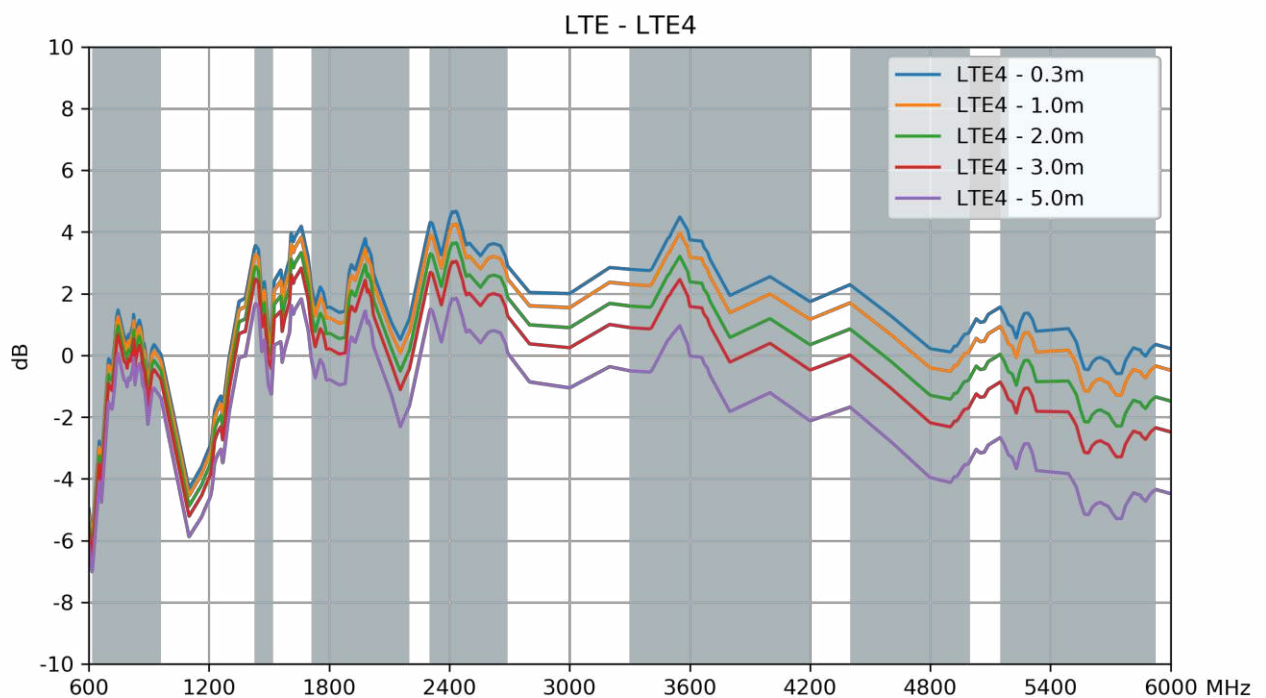

3.25 Peak Gain – Wi-Fi MIMO 1

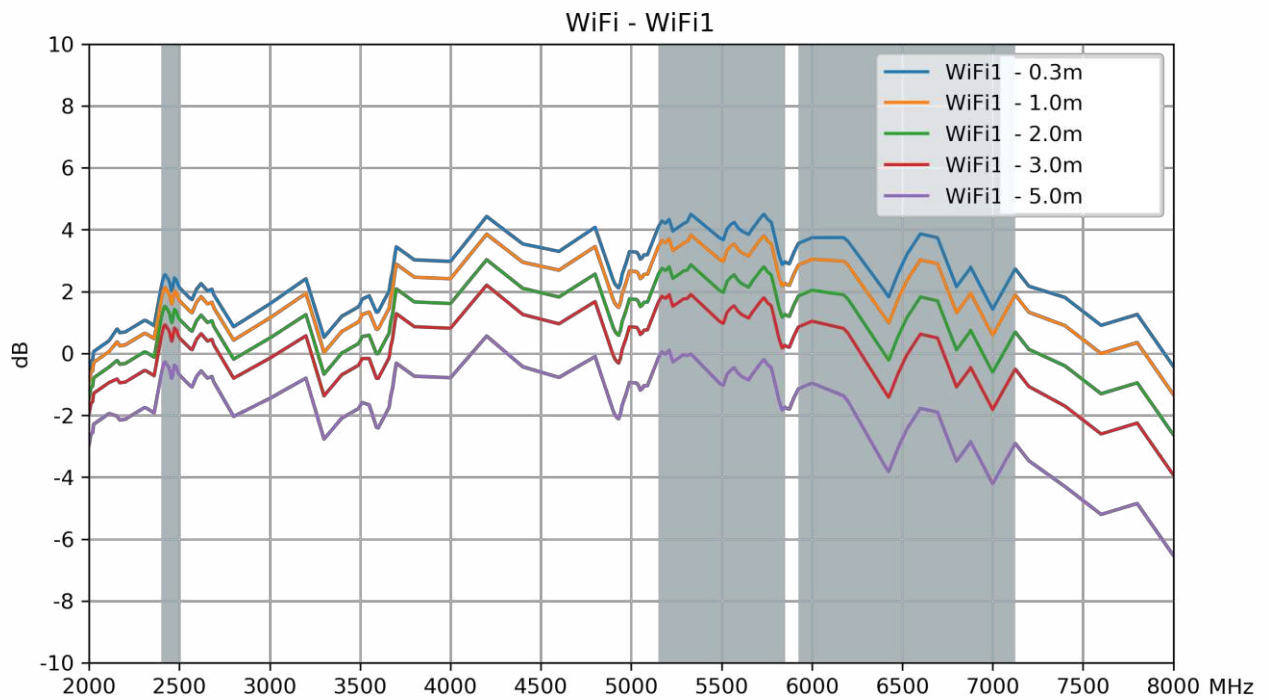

3.26 Peak Gain – Wi-Fi MIMO 2

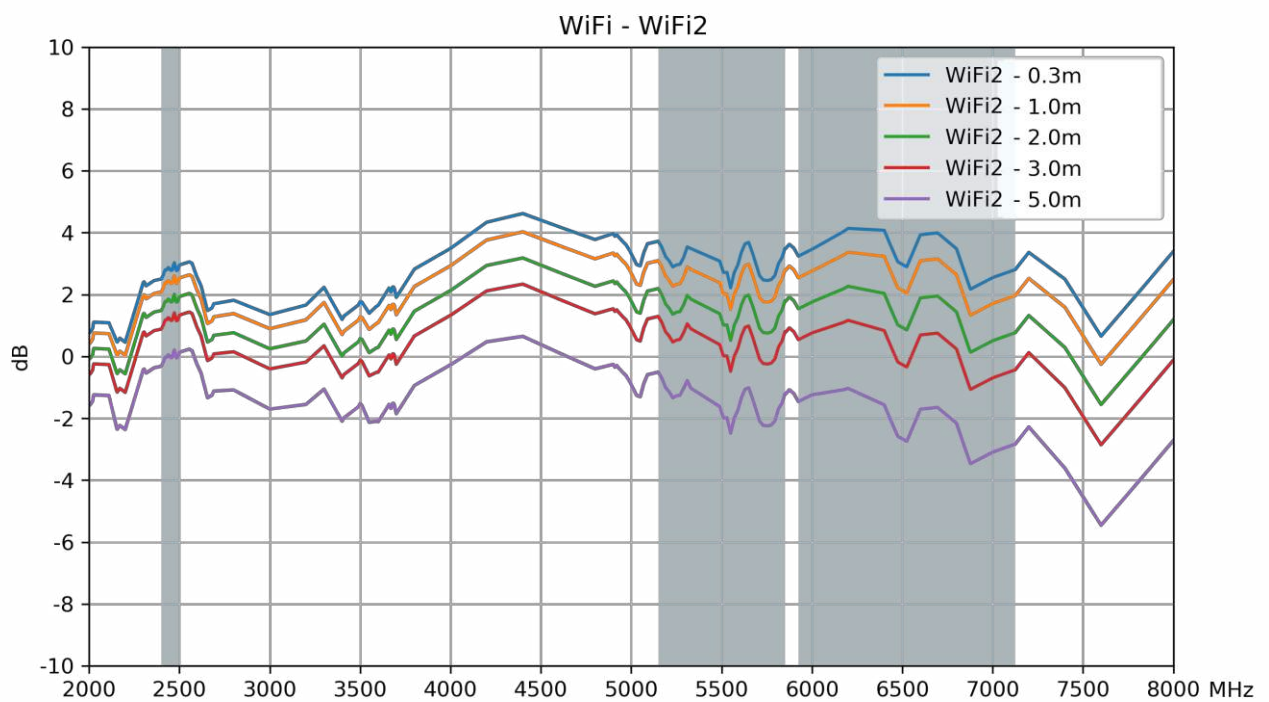

3.27 Peak Gain –Wi-Fi MIMO 3

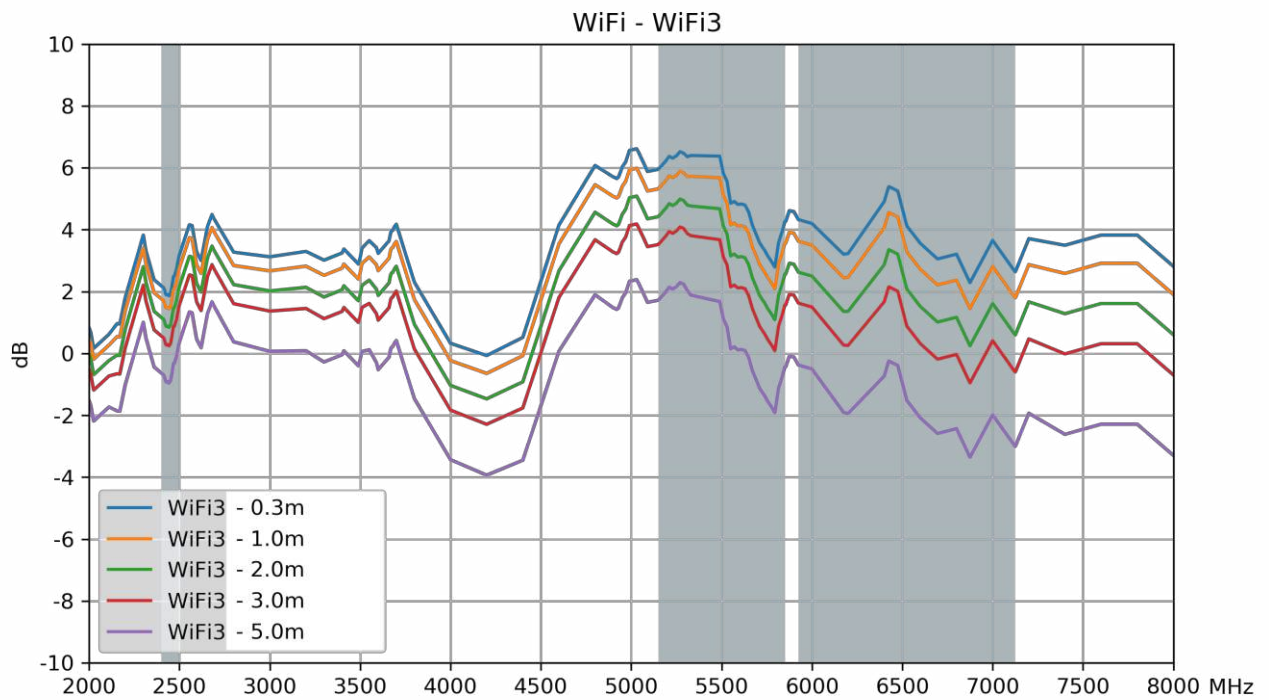

3.28 Peak Gain –Wi-Fi MIMO 4

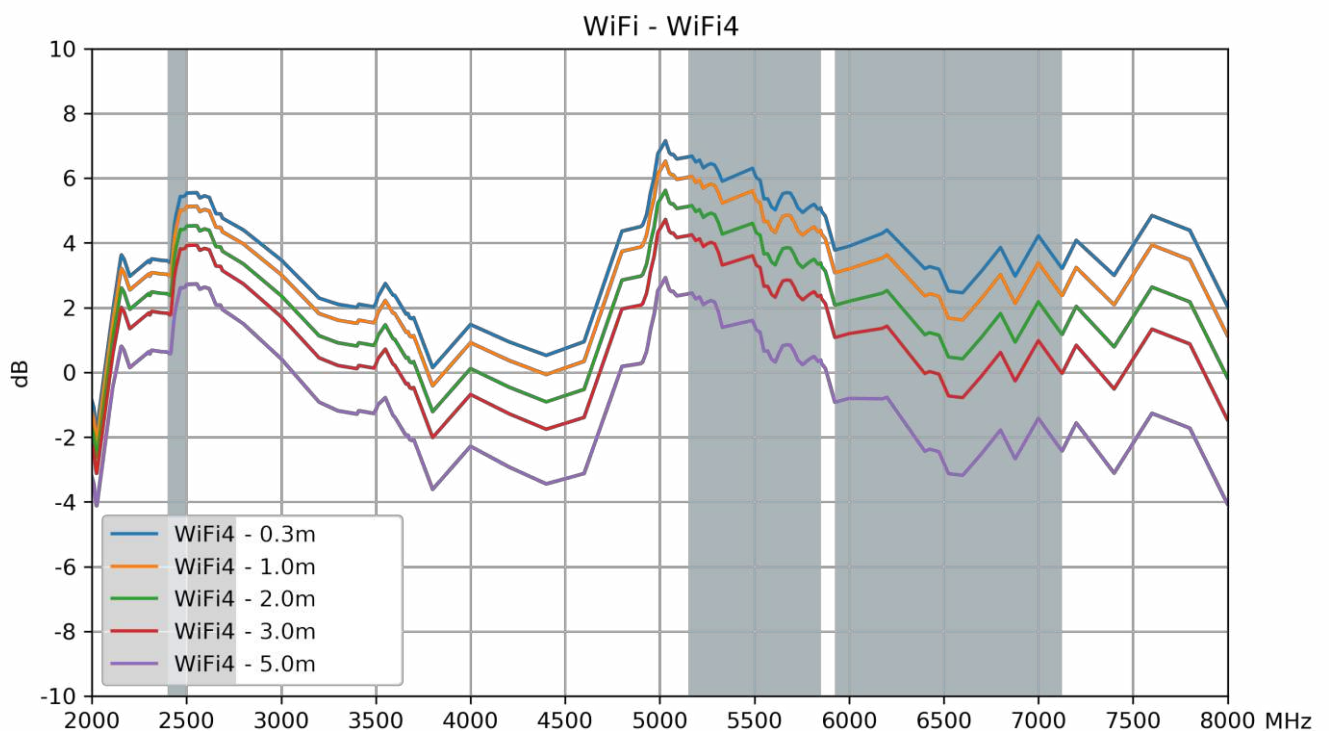

4. Active Antenna Characteristics

4.1 Block Diagram

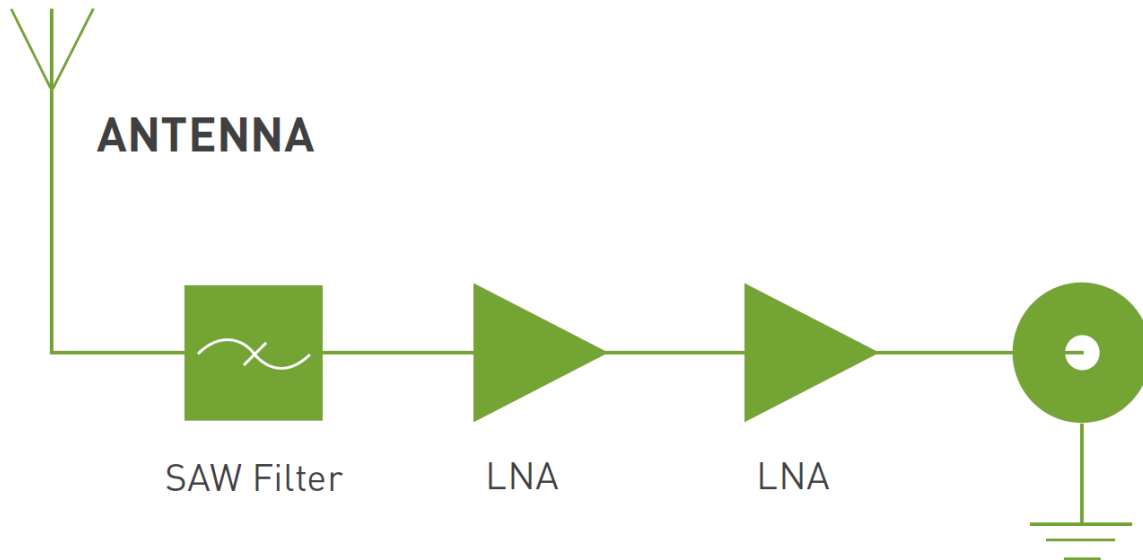

4.2 Axial Ratio

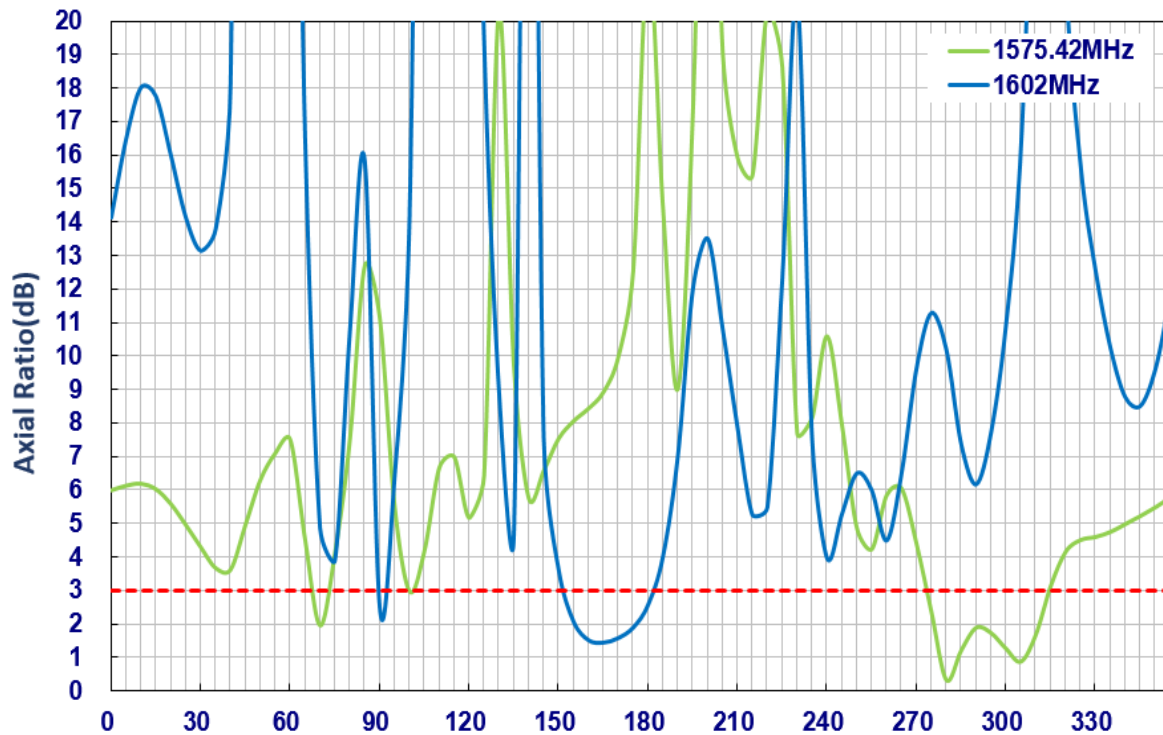

4.3 LNA Gain @3.0V

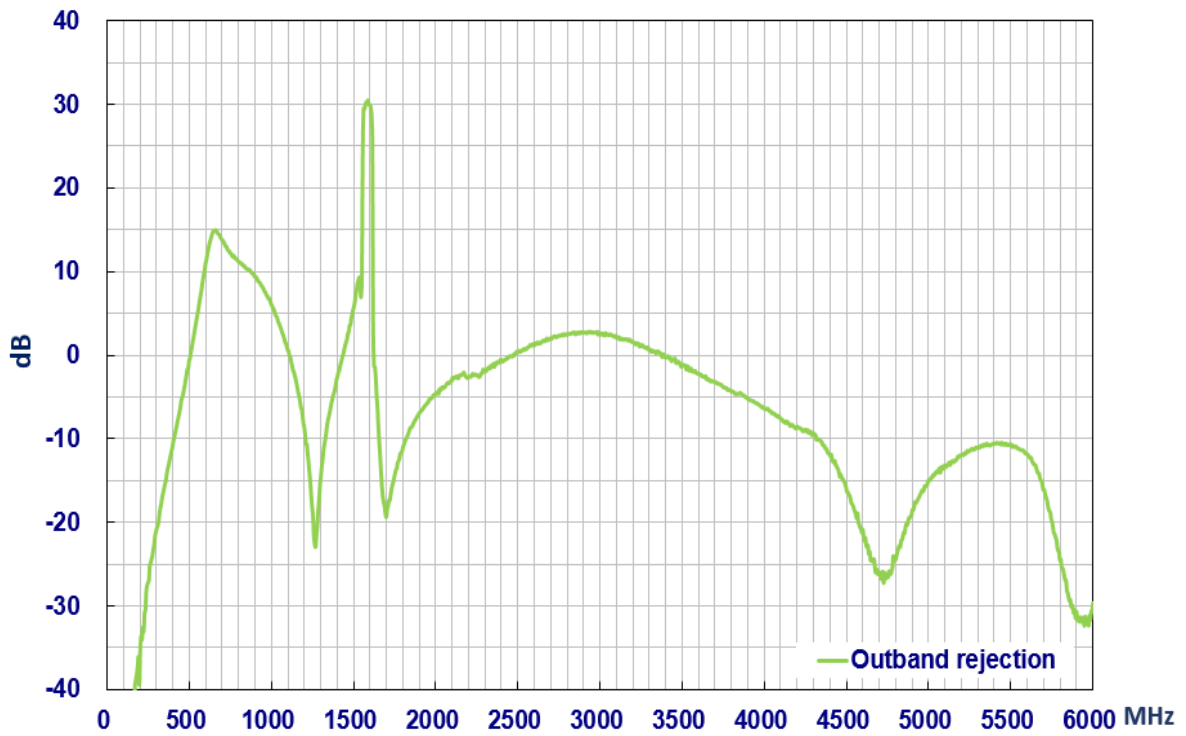

4.4 Noise Figure @3.0V

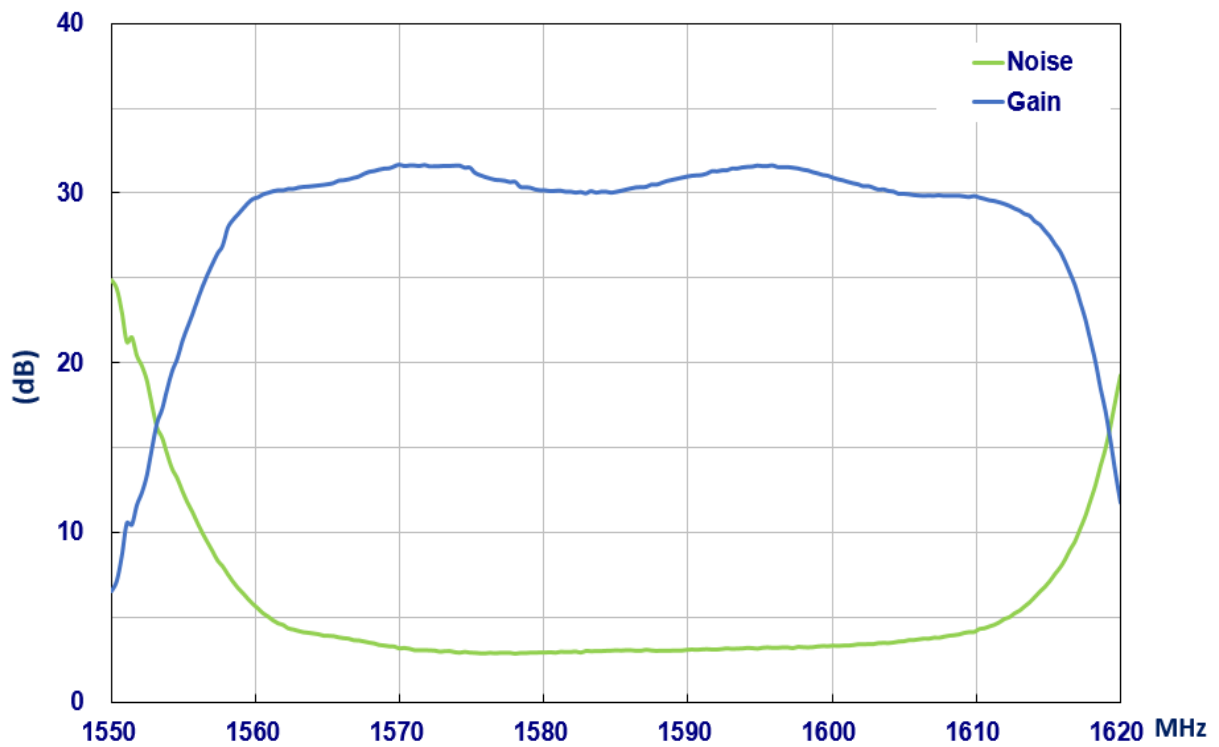

5. Radiation Patterns

5.1 GNSS 3D and 2D Radiation Patterns

1575.42MHz

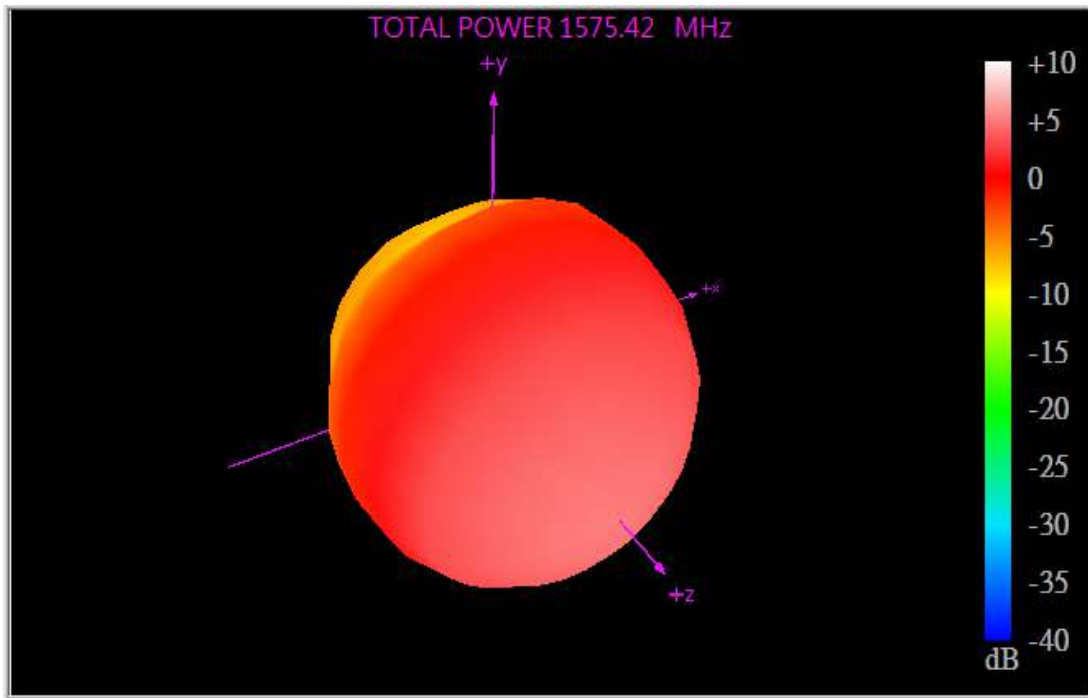

XY Plane

XZ Plane

YZ Plane

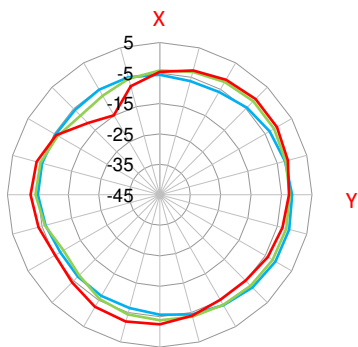

(dBi)

— 1561MHz

— 1575.42MHz

— 1602MHz

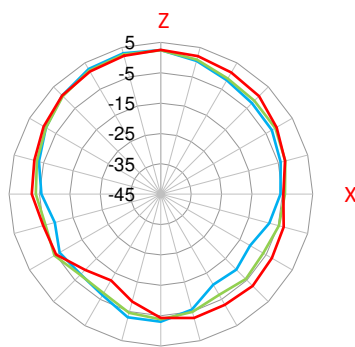

(dBi)

— 1561MHz

— 1575.42MHz

— 1602MHz

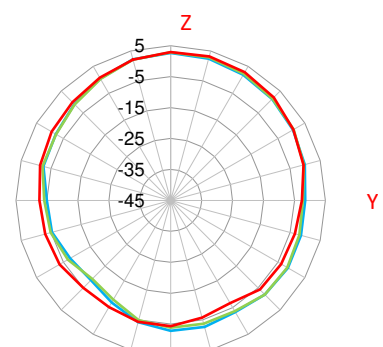

(dBi)

— 1561MHz

— 1575.42MHz

— 1602MHz

5.2 5G/4G MIMO 1 3D and 2D Radiation Patterns

652MHz

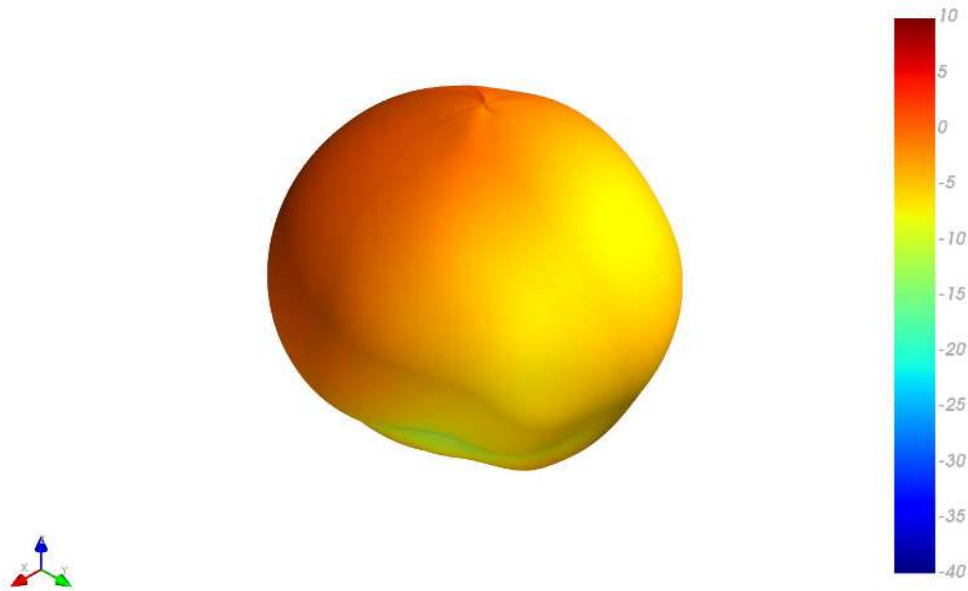

XY Plane

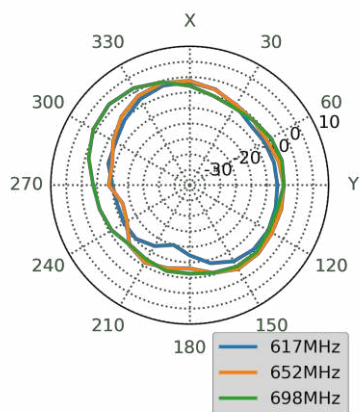

XZ Plane

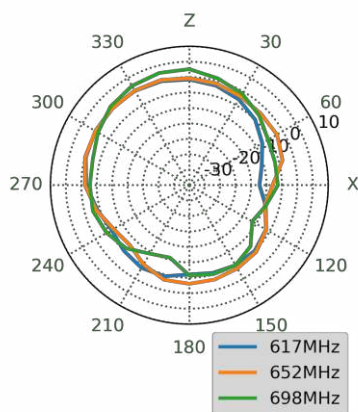

YZ Plane

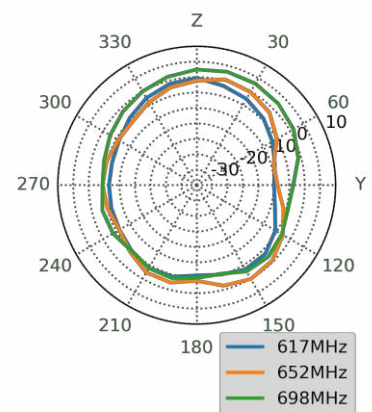

751MHz

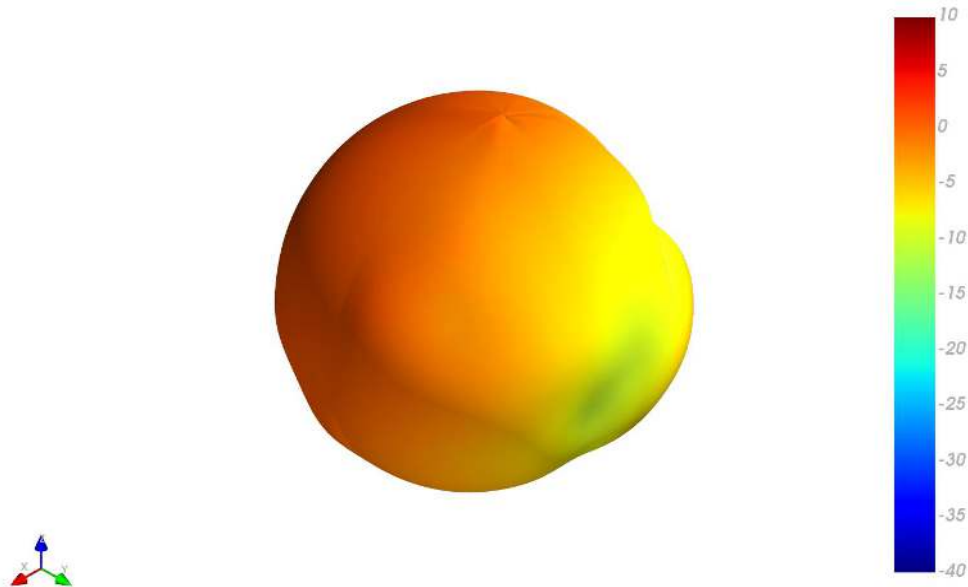

XY Plane

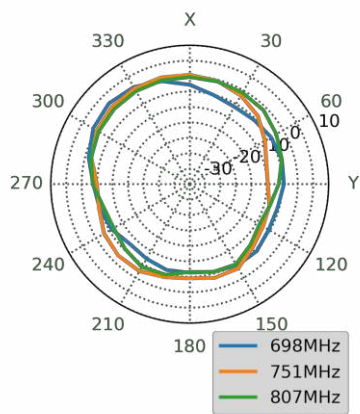

XZ Plane

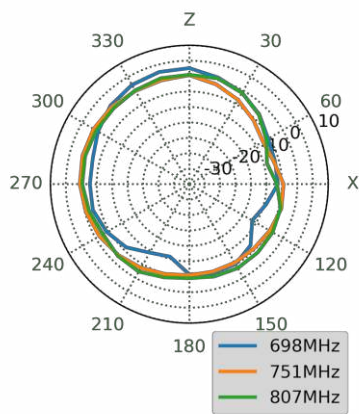

YZ Plane

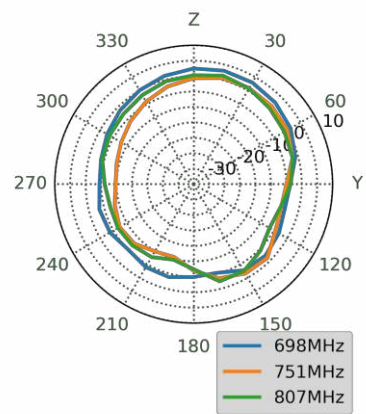

890MHz

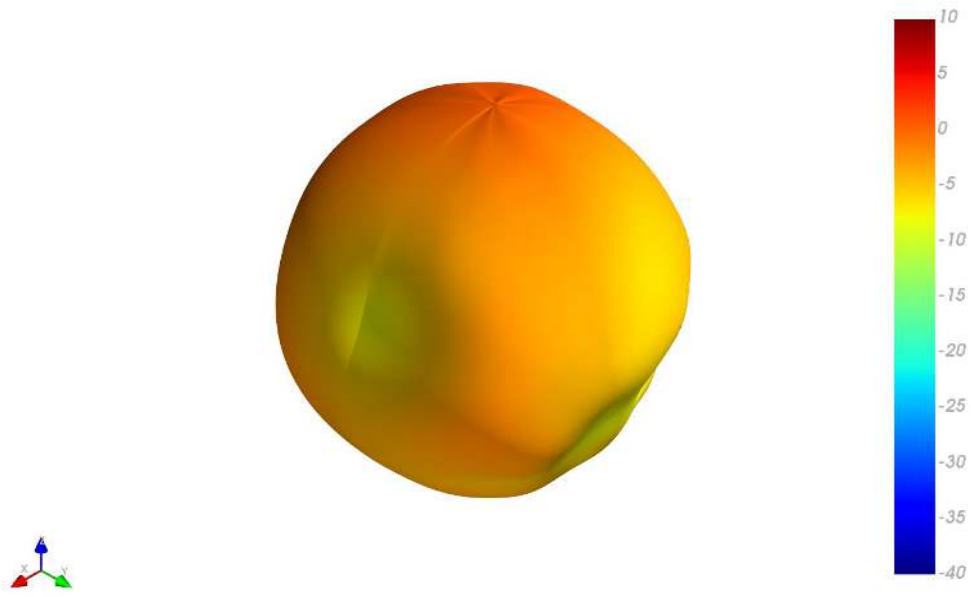

XY Plane

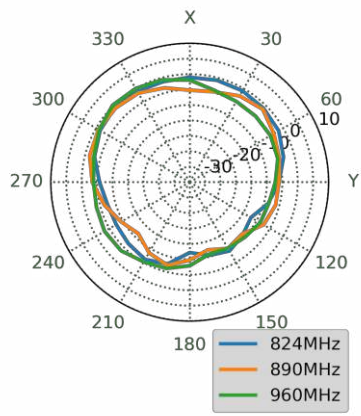

XZ Plane

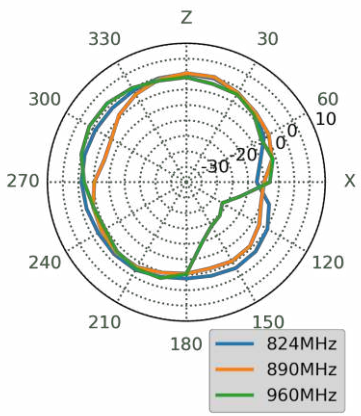

YZ Plane

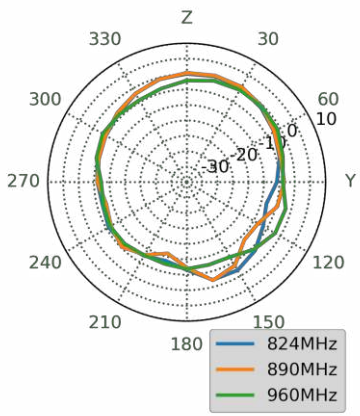

1470MHz

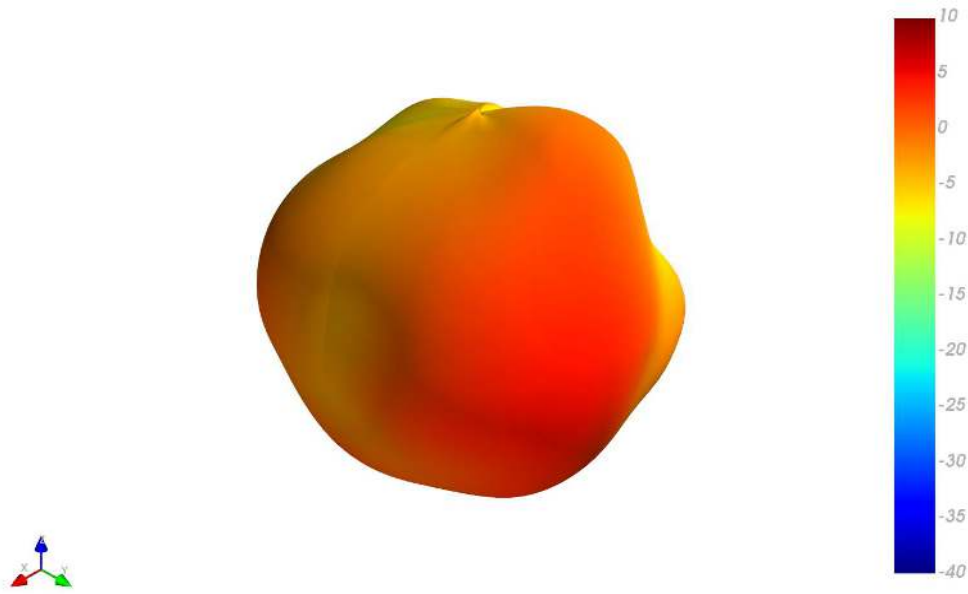

XY Plane

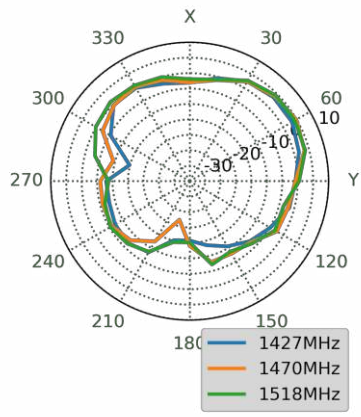

XZ Plane

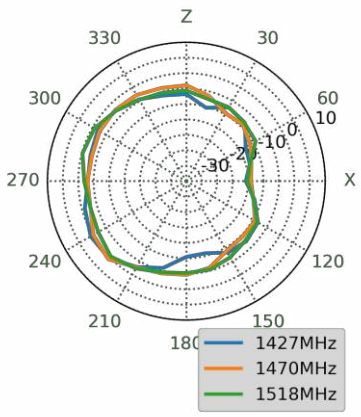

YZ Plane

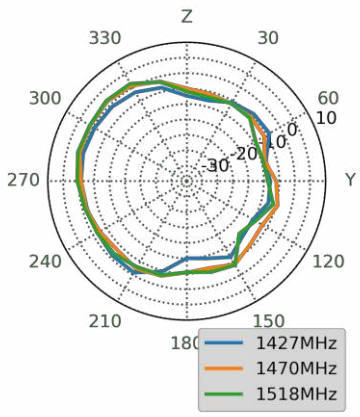

1805MHz

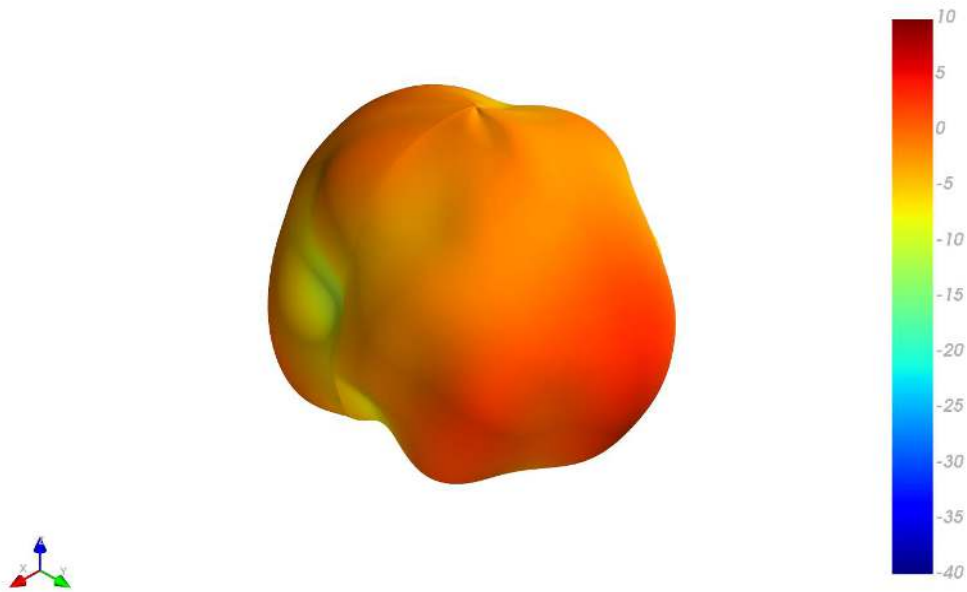

XY Plane

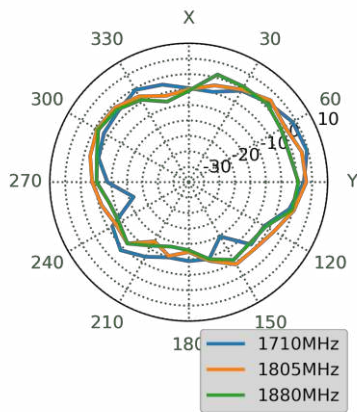

XZ Plane

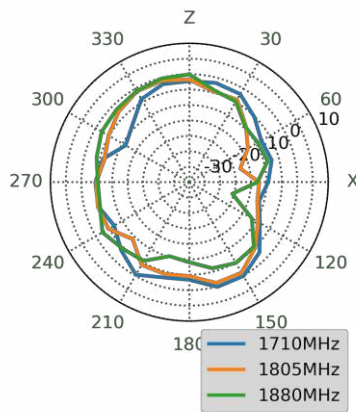

YZ Plane

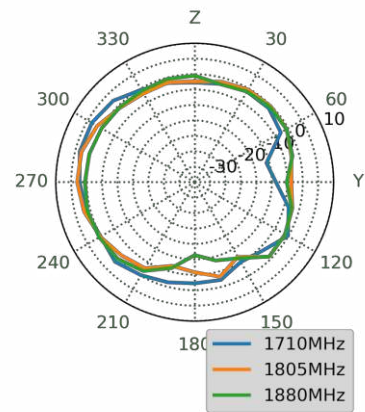

1920MHz

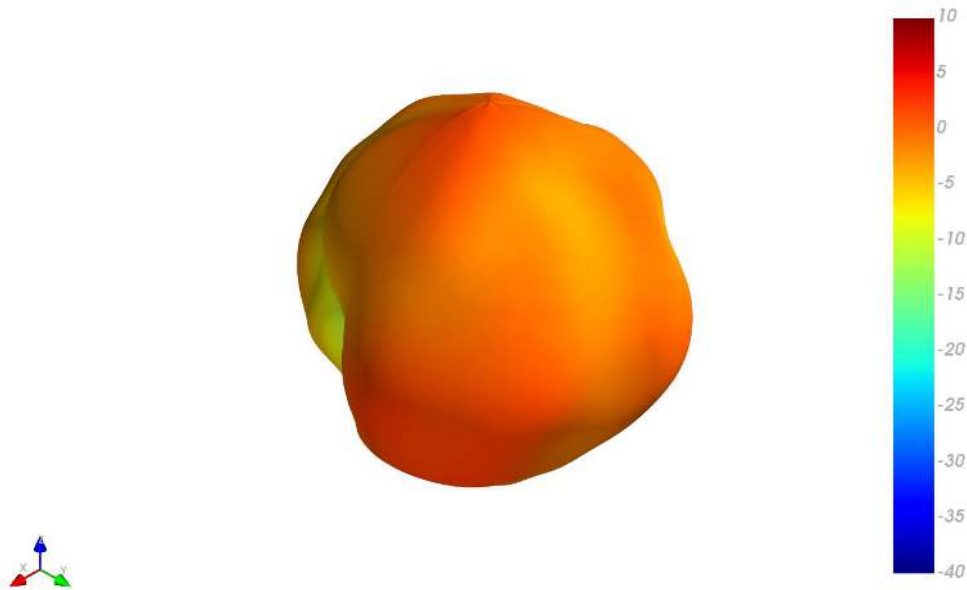

XY Plane

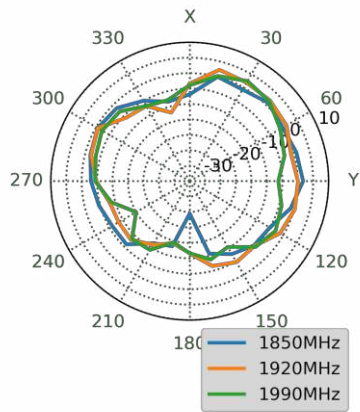

XZ Plane

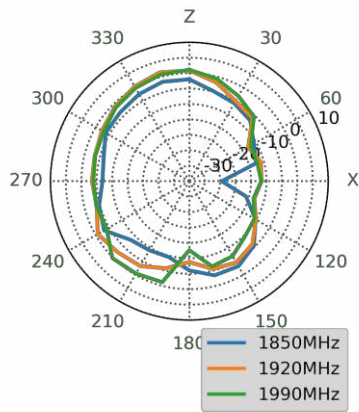

YZ Plane

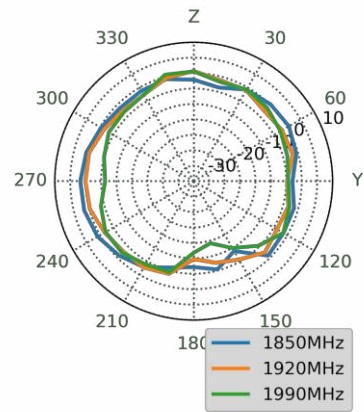

1990MHz

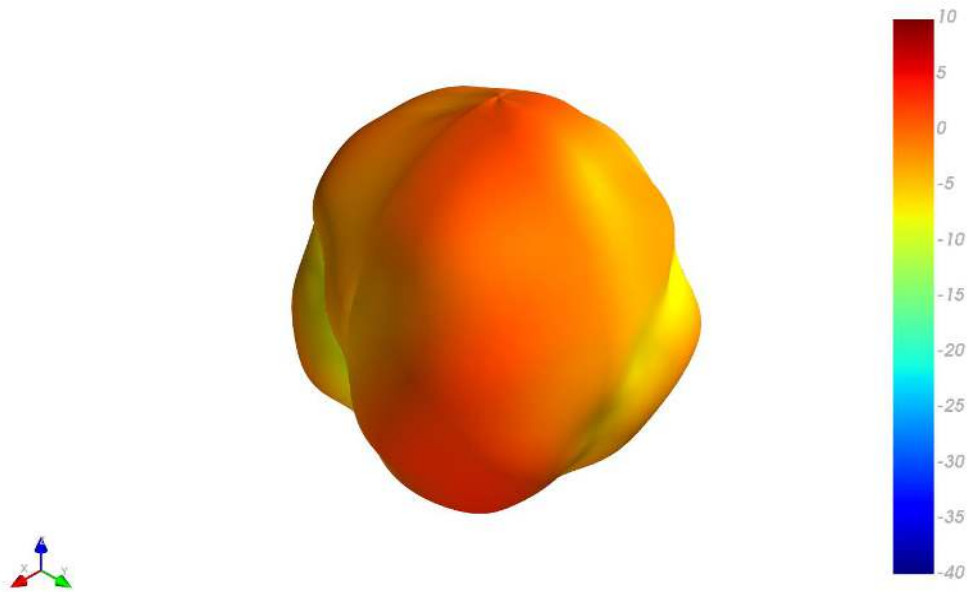

XY Plane

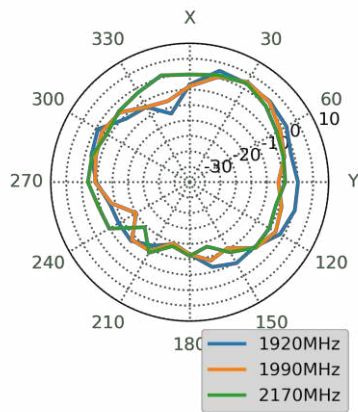

XZ Plane

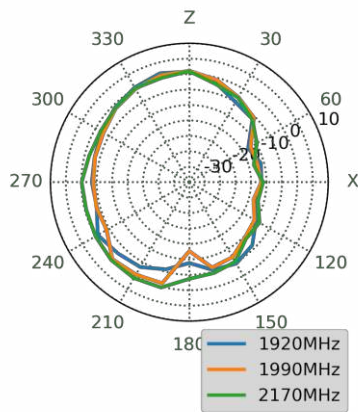

YZ Plane

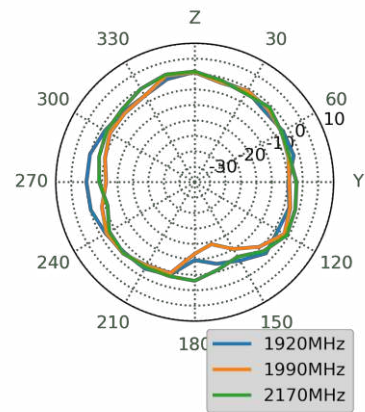

2595MHz

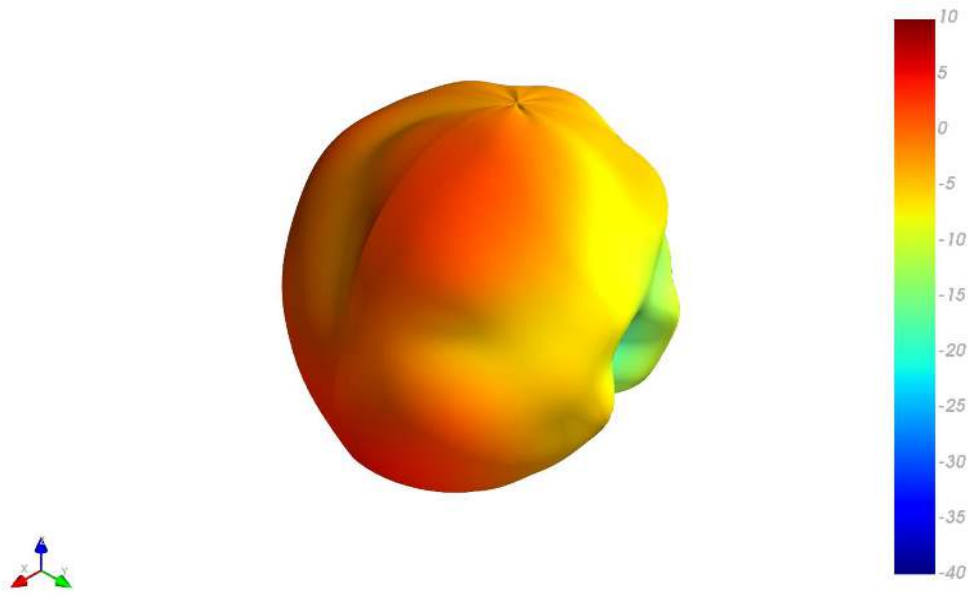

XY Plane

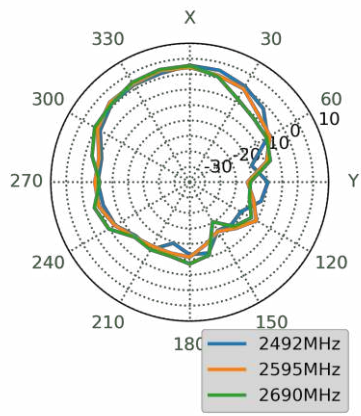

XZ Plane

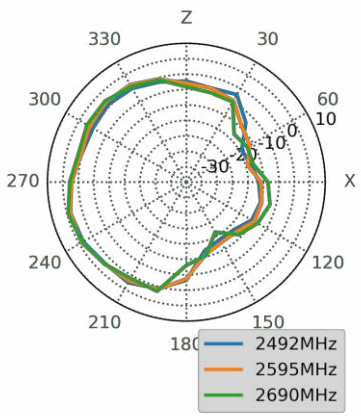

YZ Plane

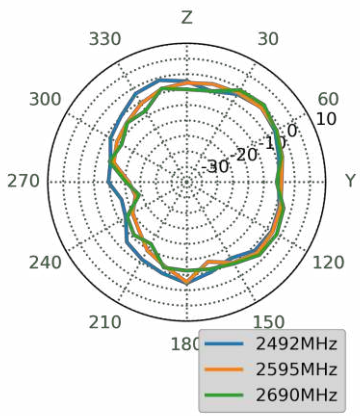

3550MHz

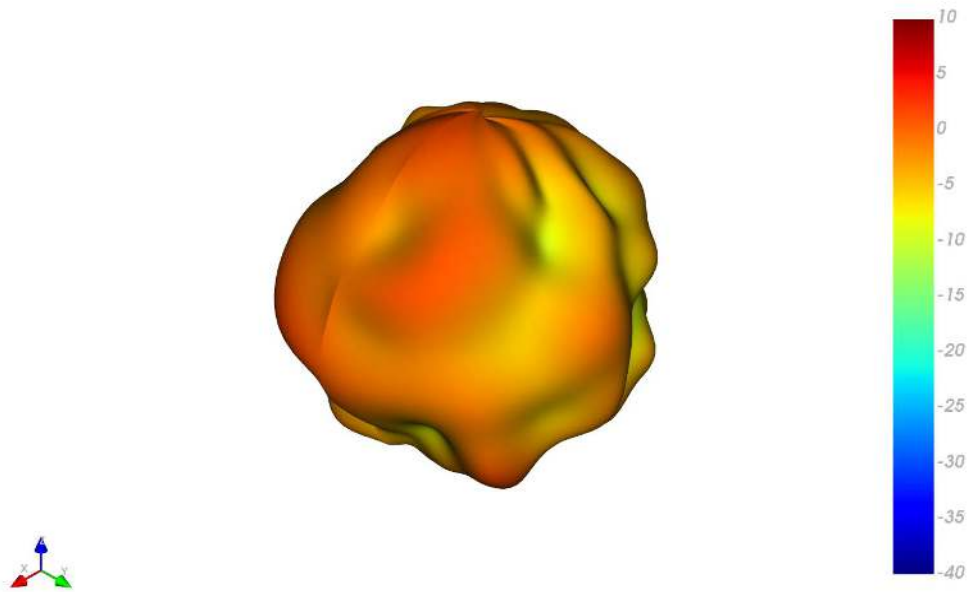

XY Plane

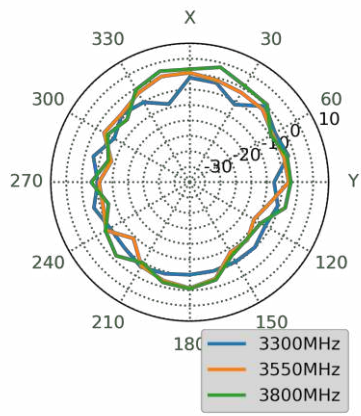

XZ Plane

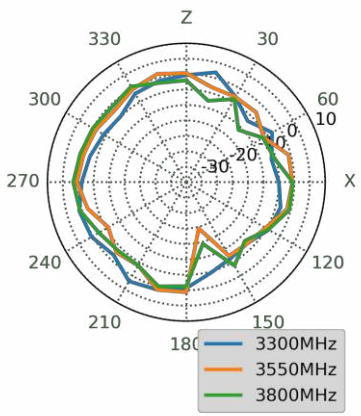

YZ Plane

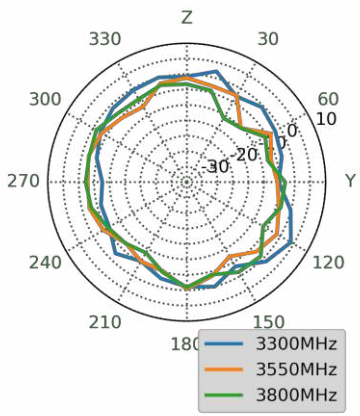

5.3 5G/4G MIMO 2 3D and 2D Radiation Patterns

652MHz

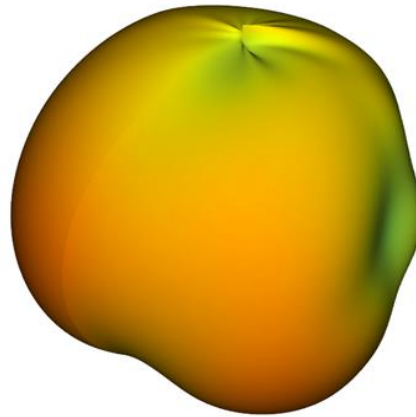

XY Plane

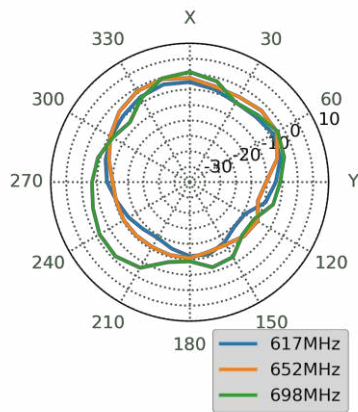

XZ Plane

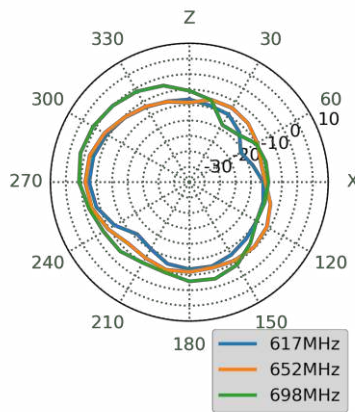

YZ Plane

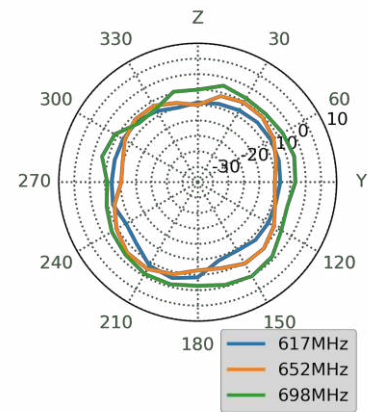

751MHz

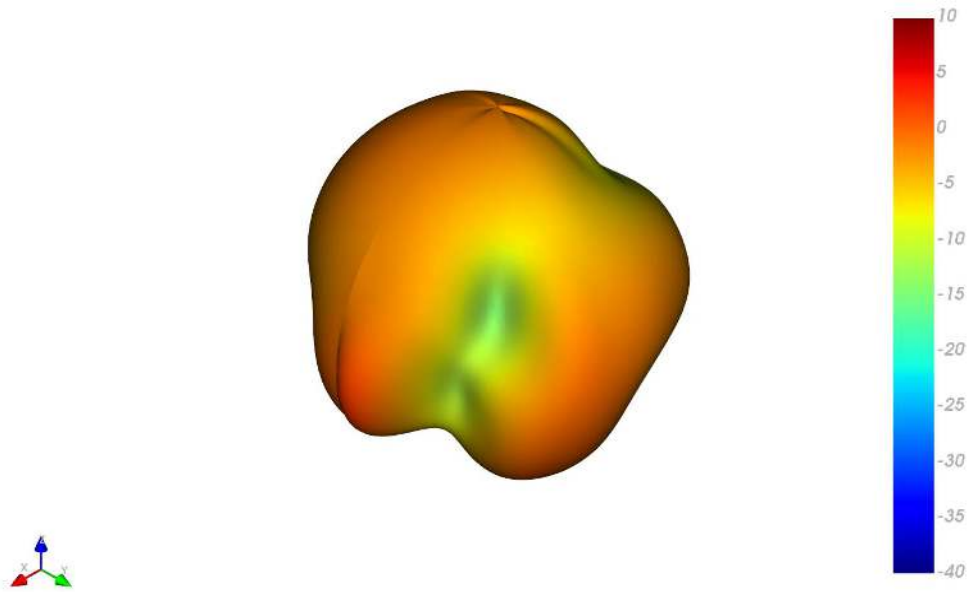

XY Plane

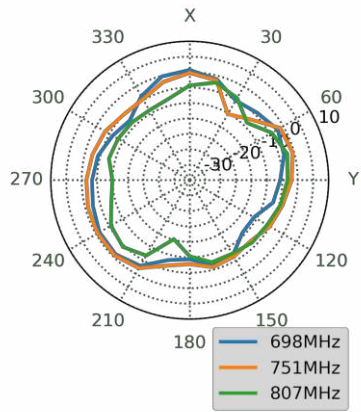

XZ Plane

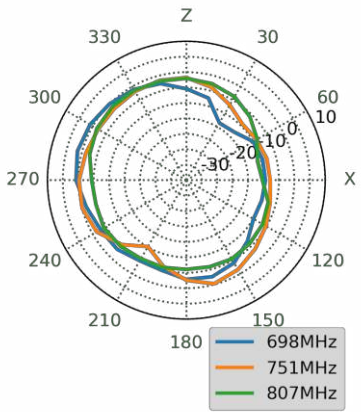

YZ Plane

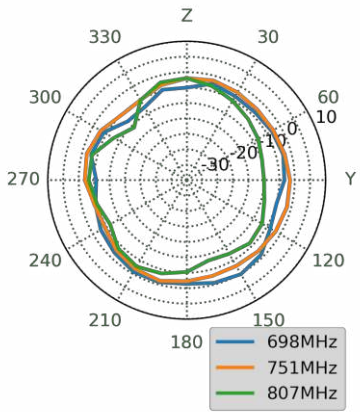

890MHz

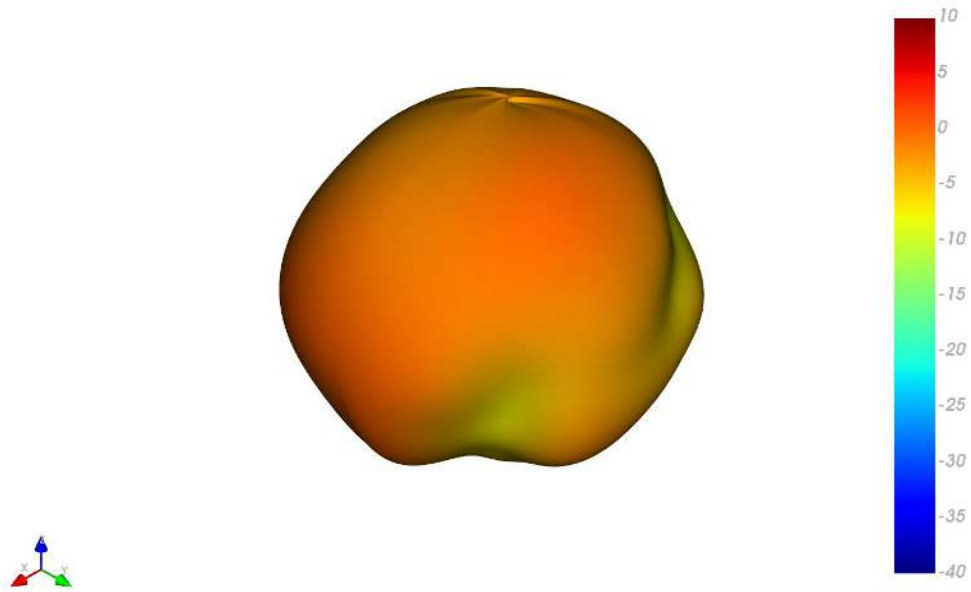

XY Plane

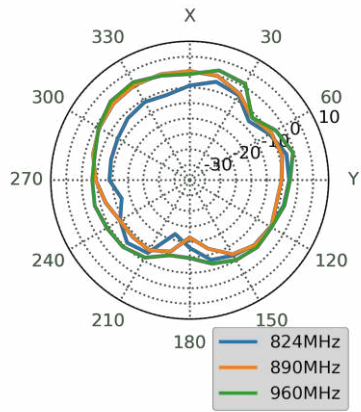

XZ Plane

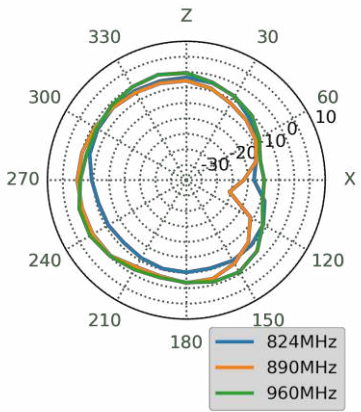

YZ Plane

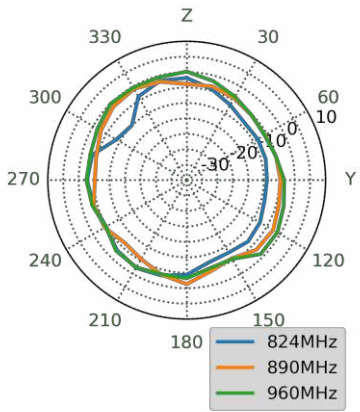

1470MHz

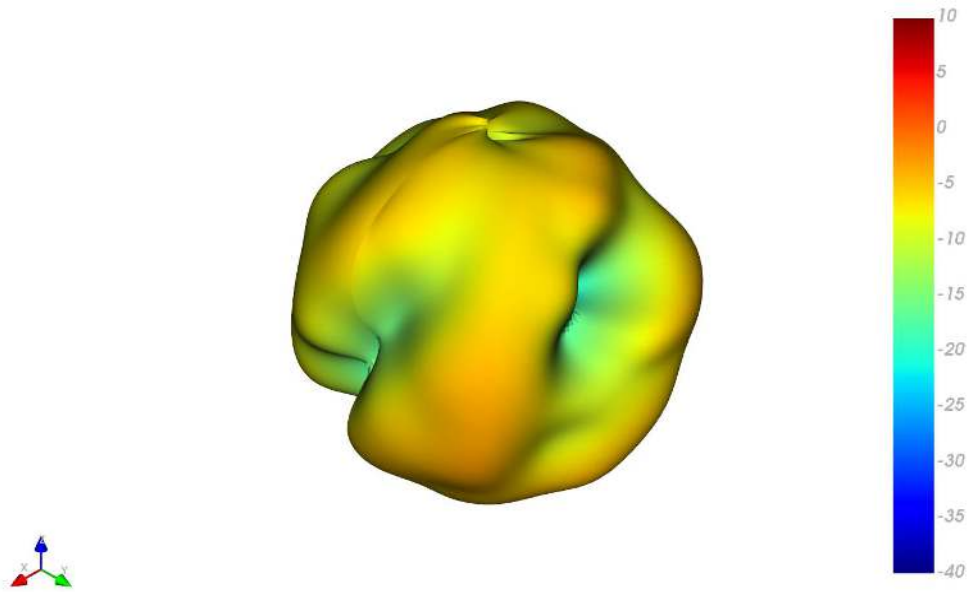

XY Plane

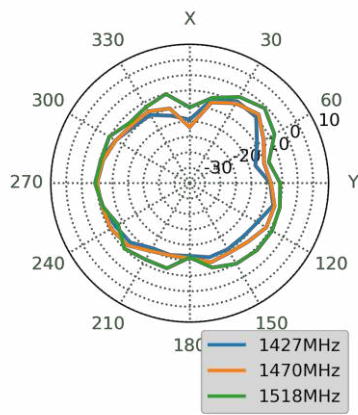

XZ Plane

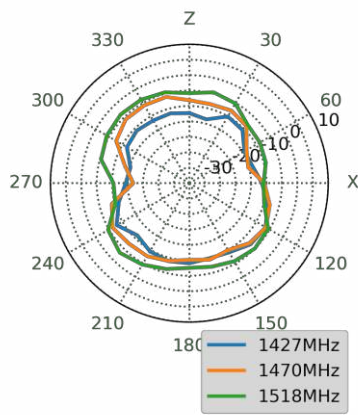

YZ Plane

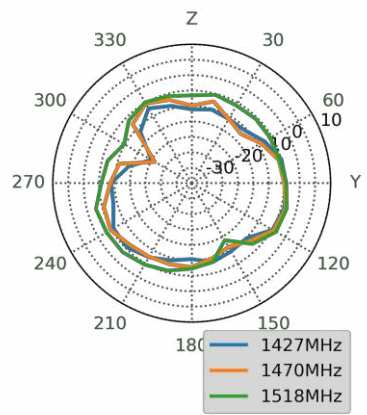

1805MHz

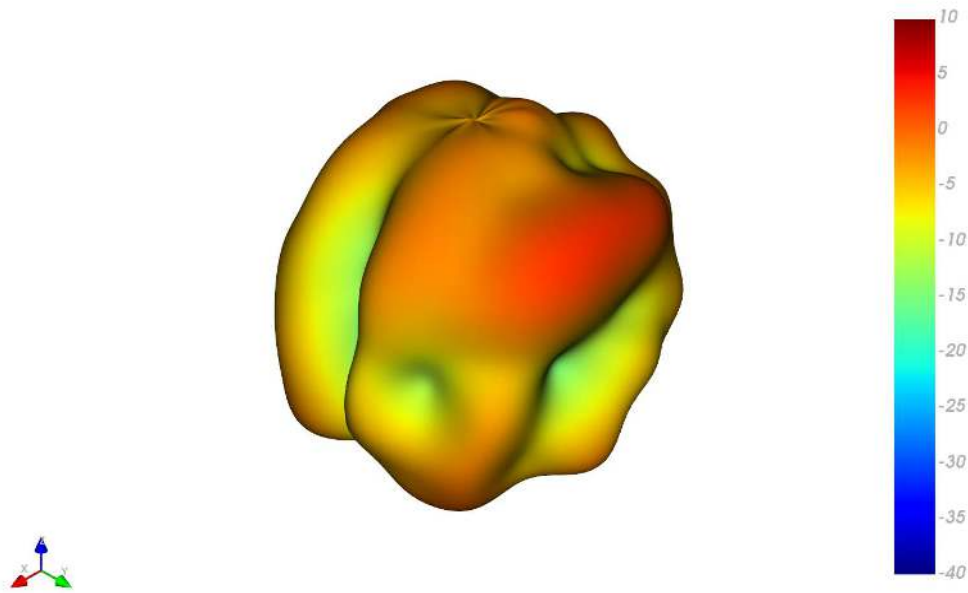

XY Plane

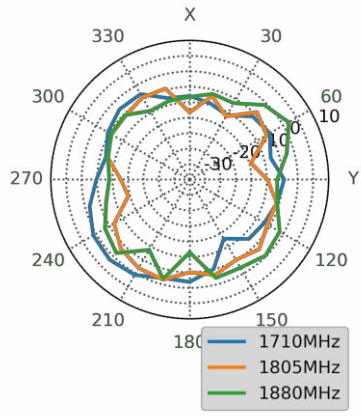

XZ Plane

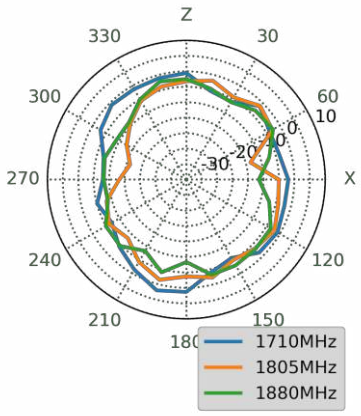

YZ Plane

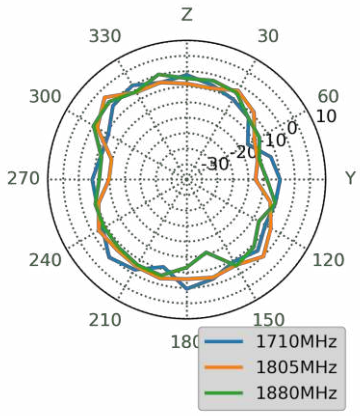

1920MHz

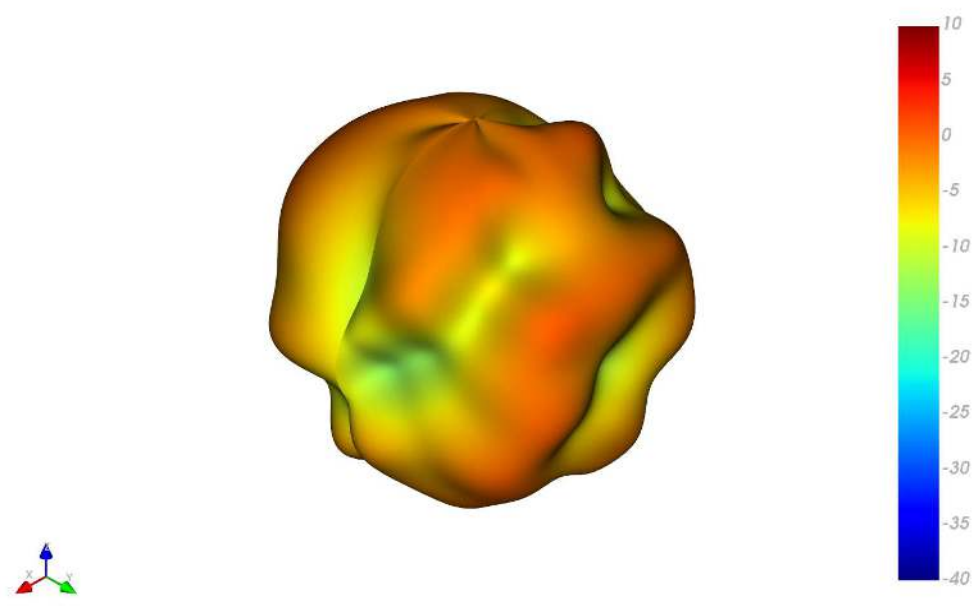

XY Plane

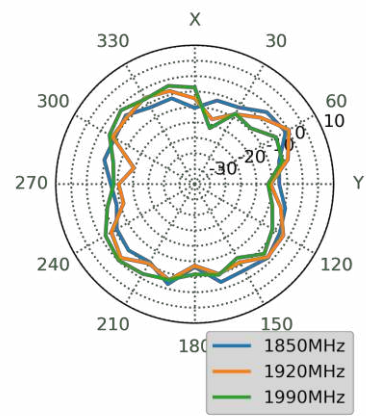

XZ Plane

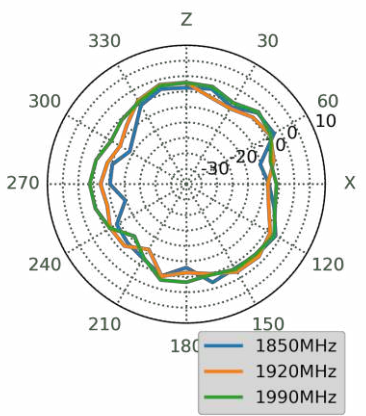

YZ Plane

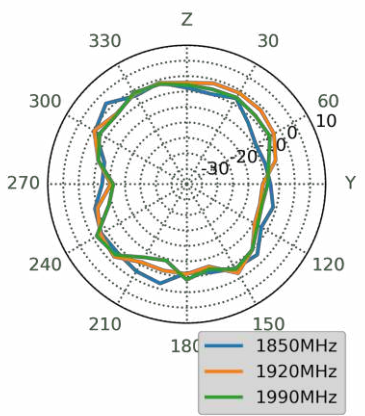

1990MHz

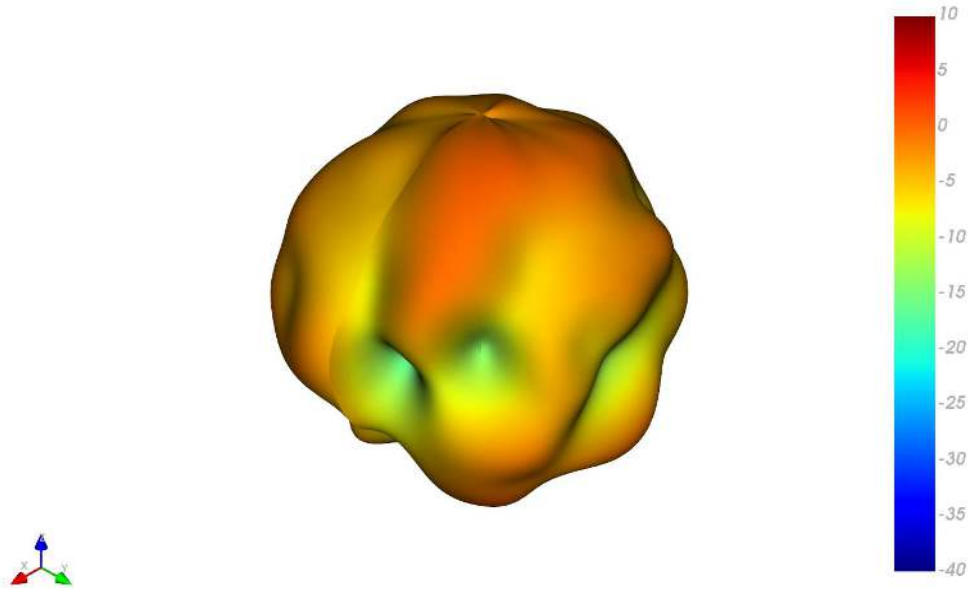

XY Plane

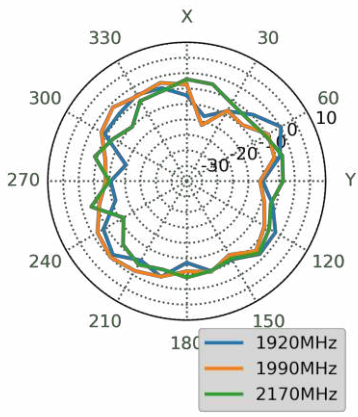

XZ Plane

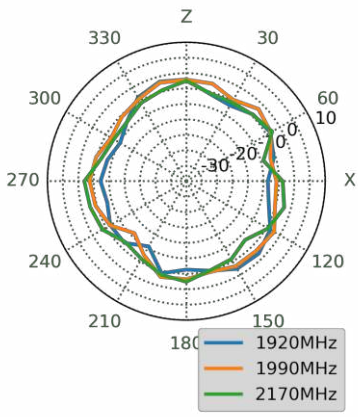

YZ Plane

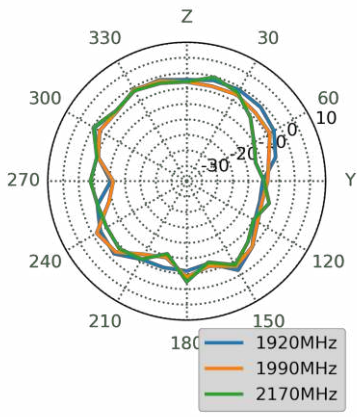

2595MHz

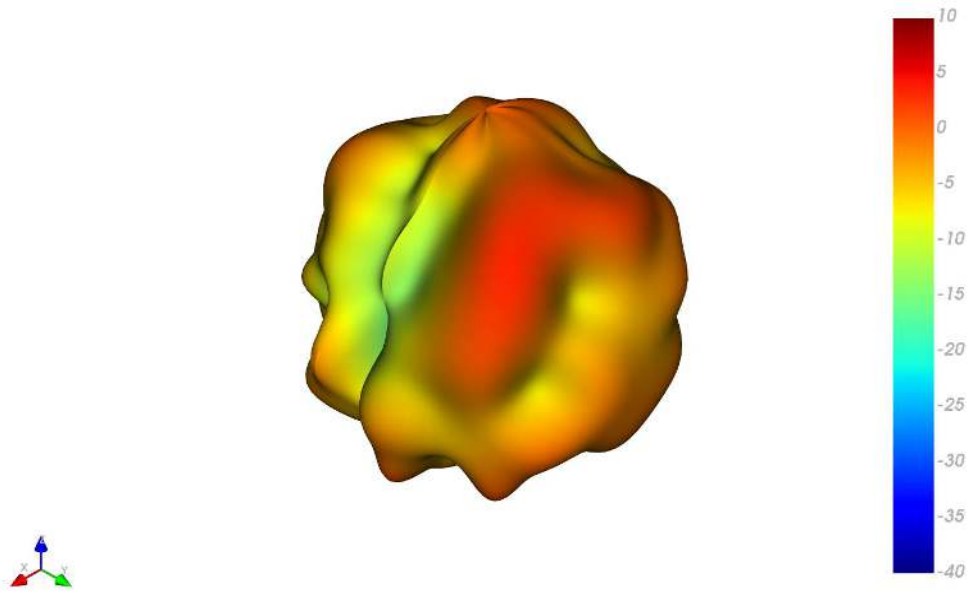

XY Plane

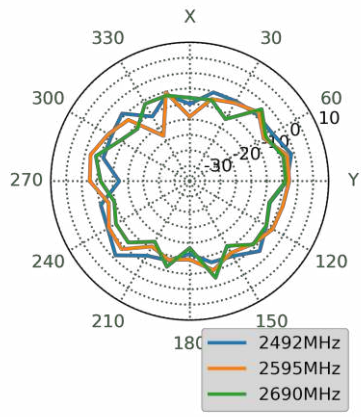

XZ Plane

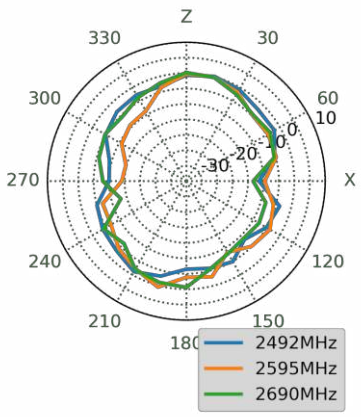

YZ Plane

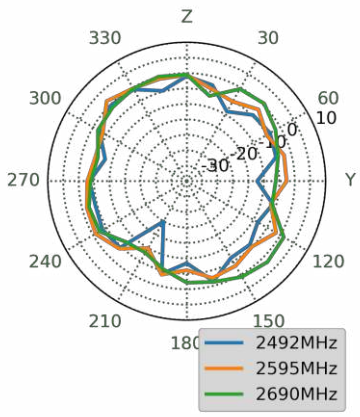

3550MHz

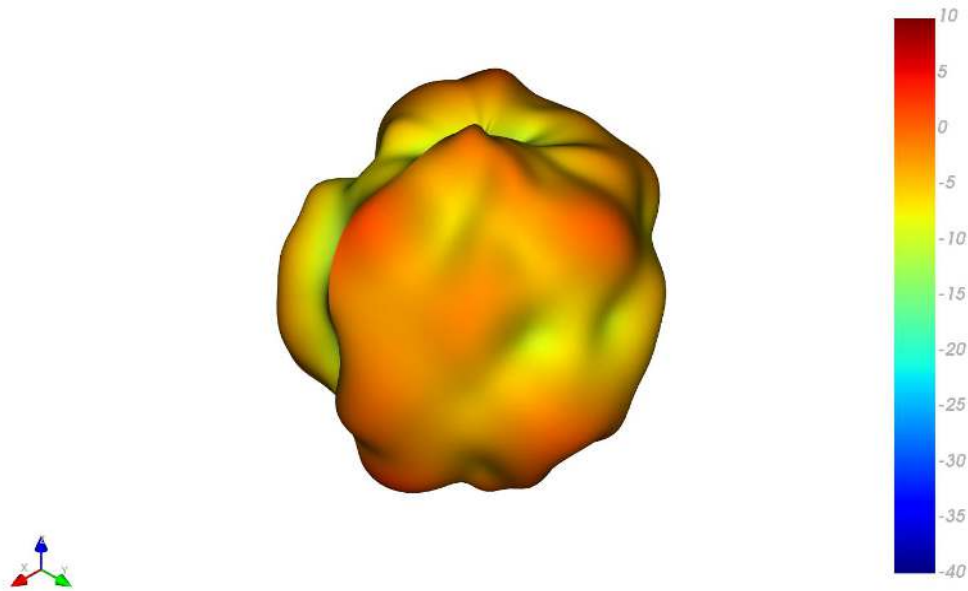

XY Plane

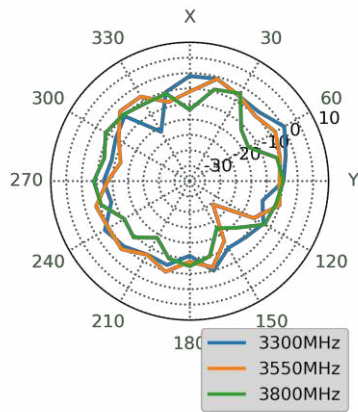

XZ Plane

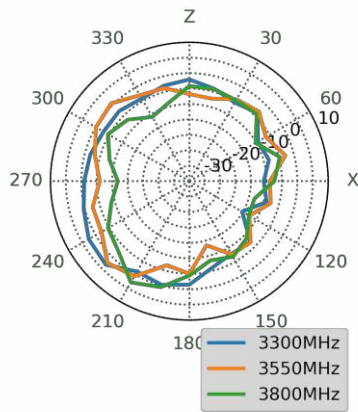

YZ Plane

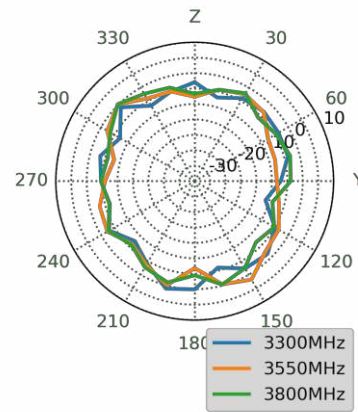

5.4 5G/4G MIMO 3 3D and 2D Radiation Patterns

652MHz

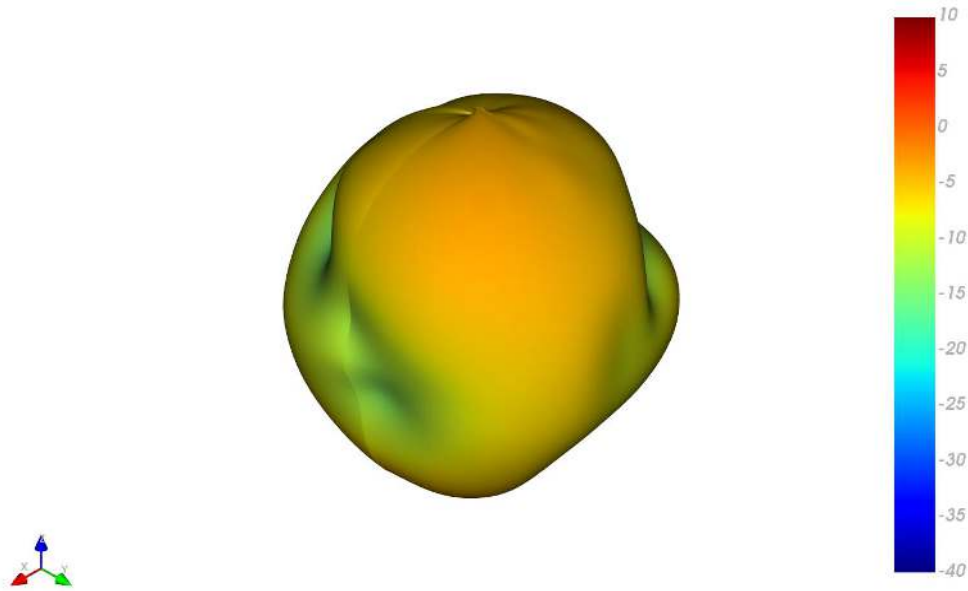

XY Plane

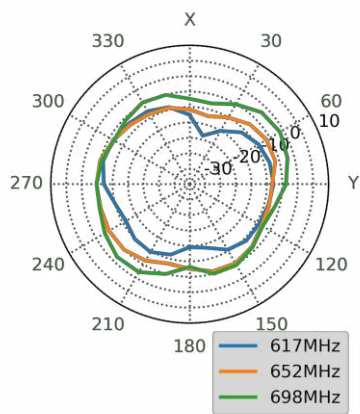

XZ Plane

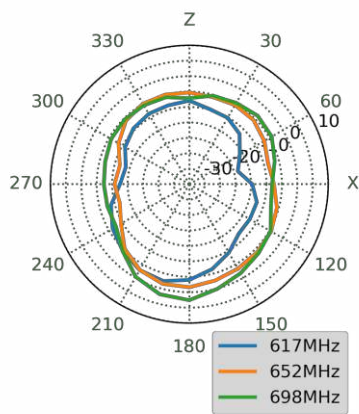

YZ Plane

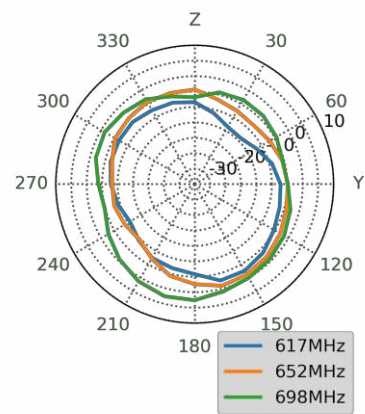

751MHz

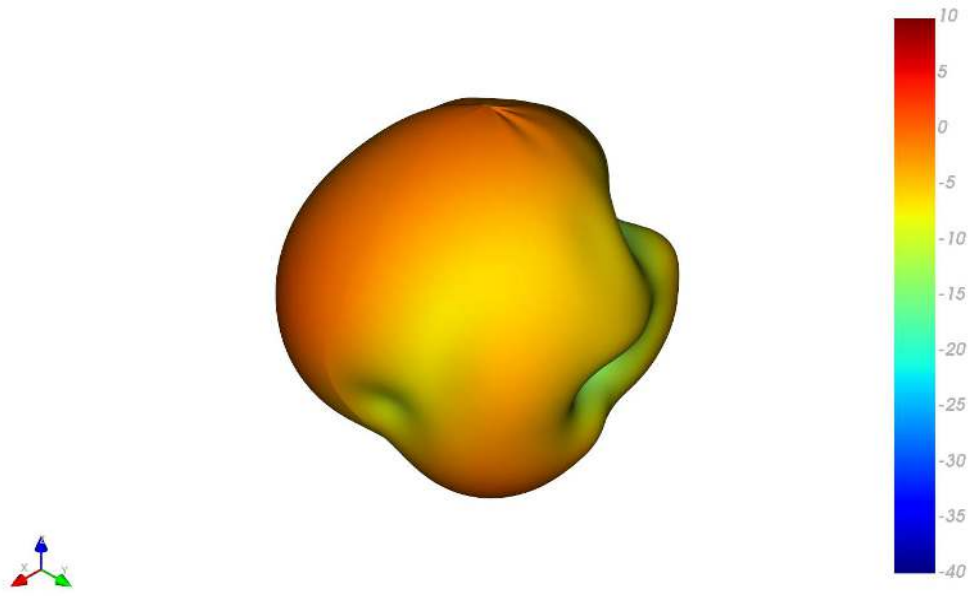

XY Plane

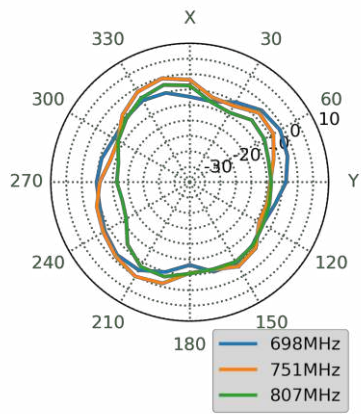

XZ Plane

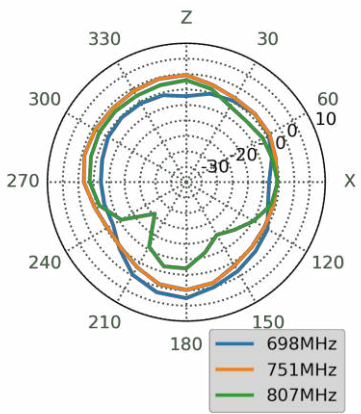

YZ Plane

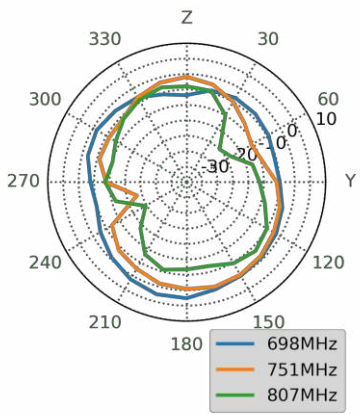

890MHz

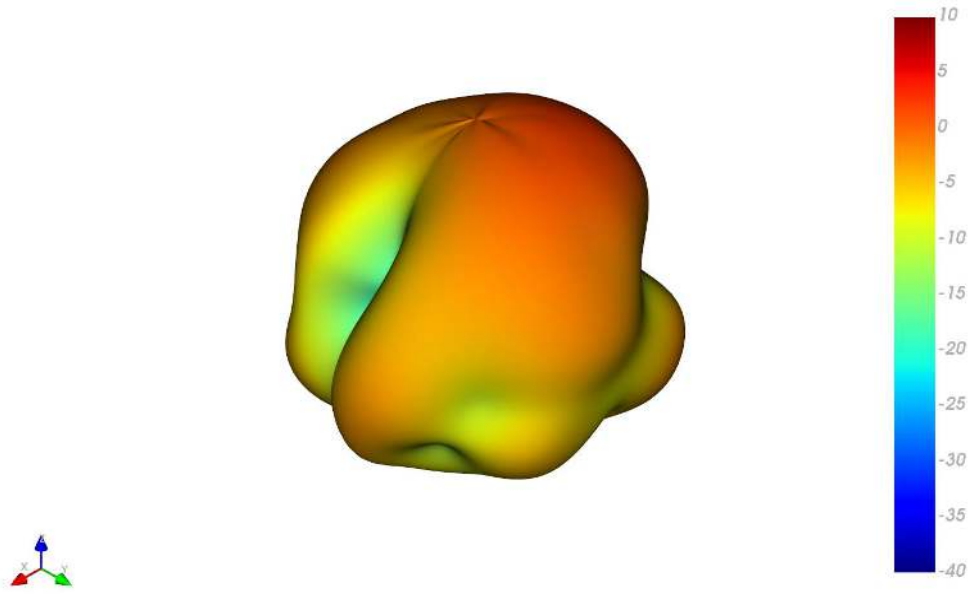

XY Plane

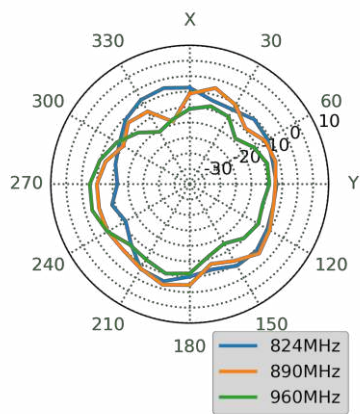

XZ Plane

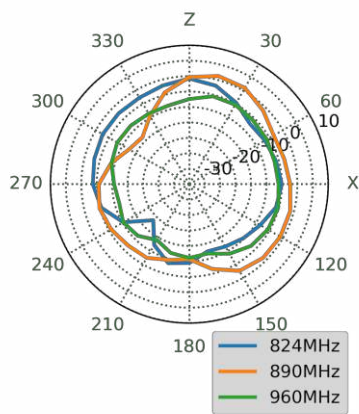

YZ Plane

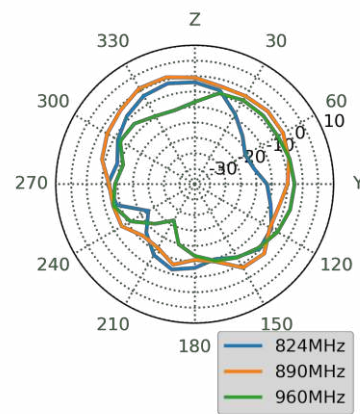

1470MHz

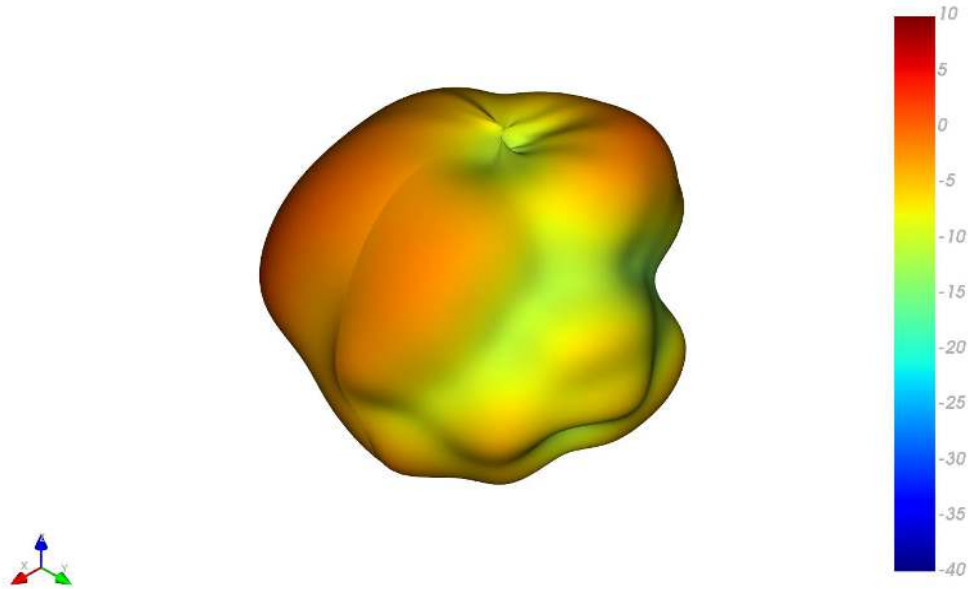

XY Plane

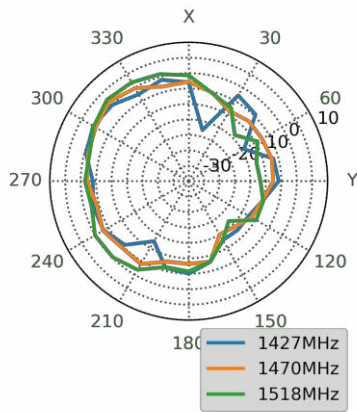

XZ Plane

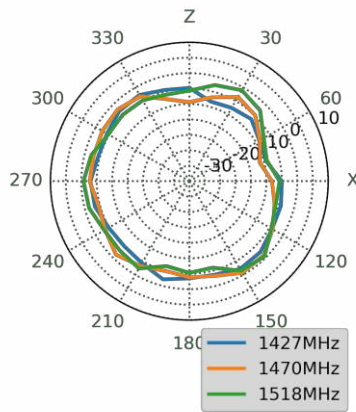

YZ Plane

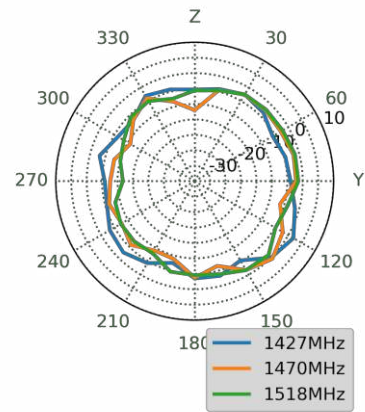

1805MHz

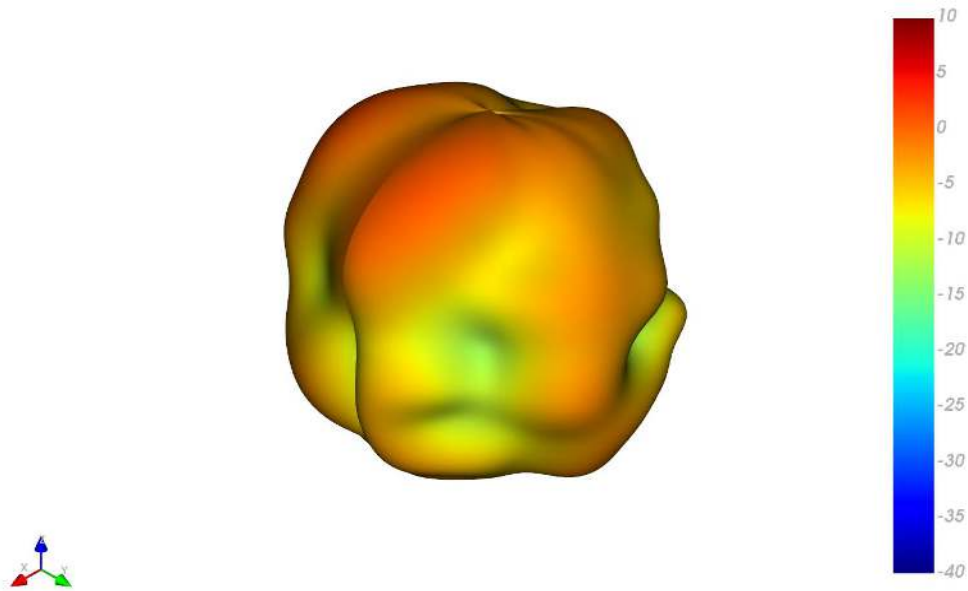

XY Plane

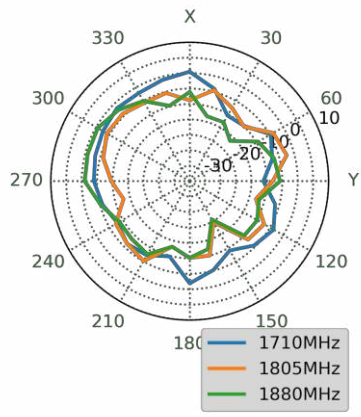

XZ Plane

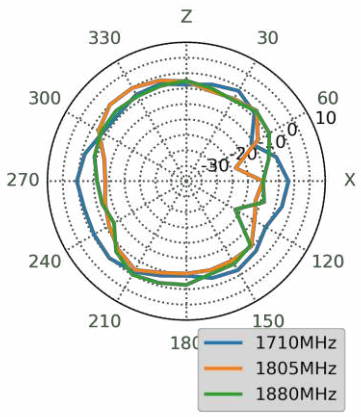

YZ Plane

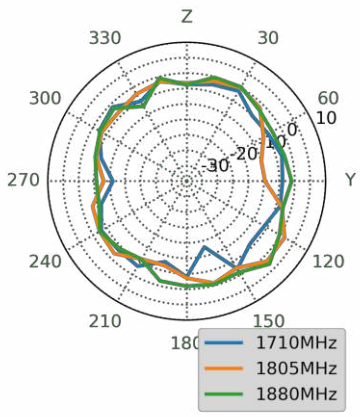

1920MHz

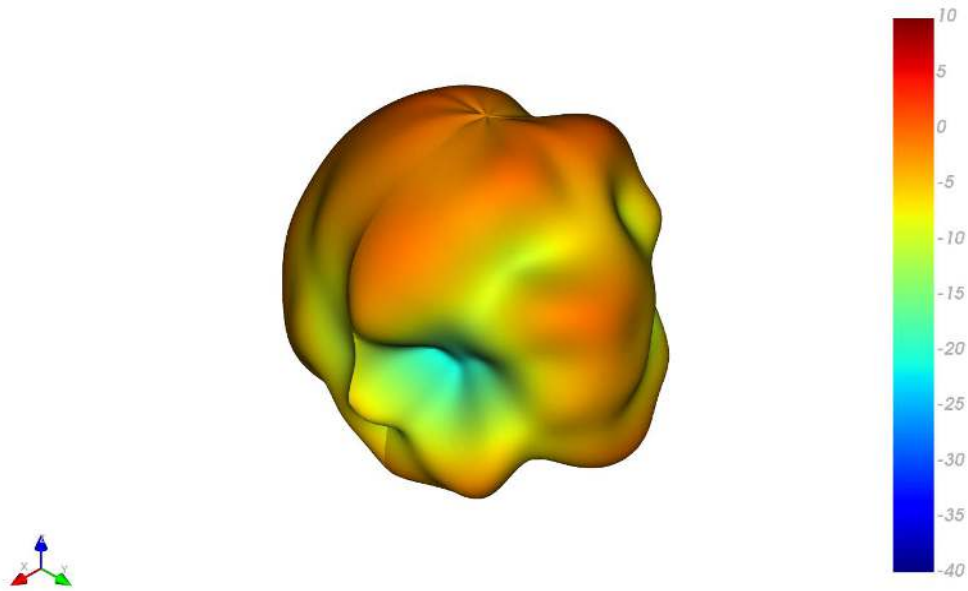

XY Plane

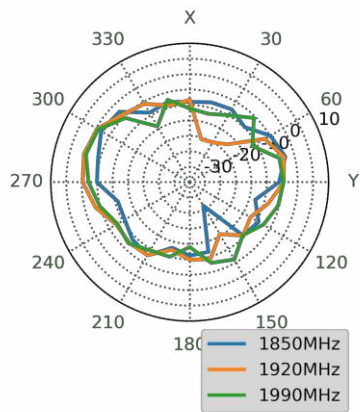

XZ Plane

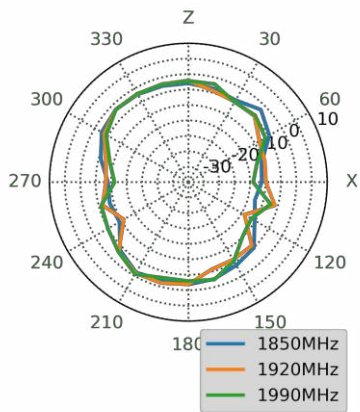

YZ Plane

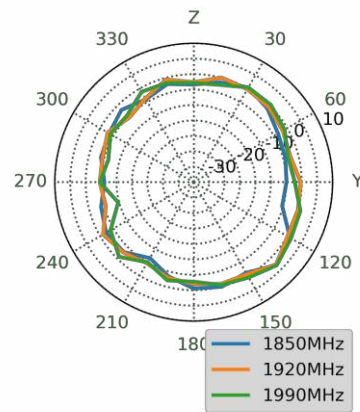

1990MHz

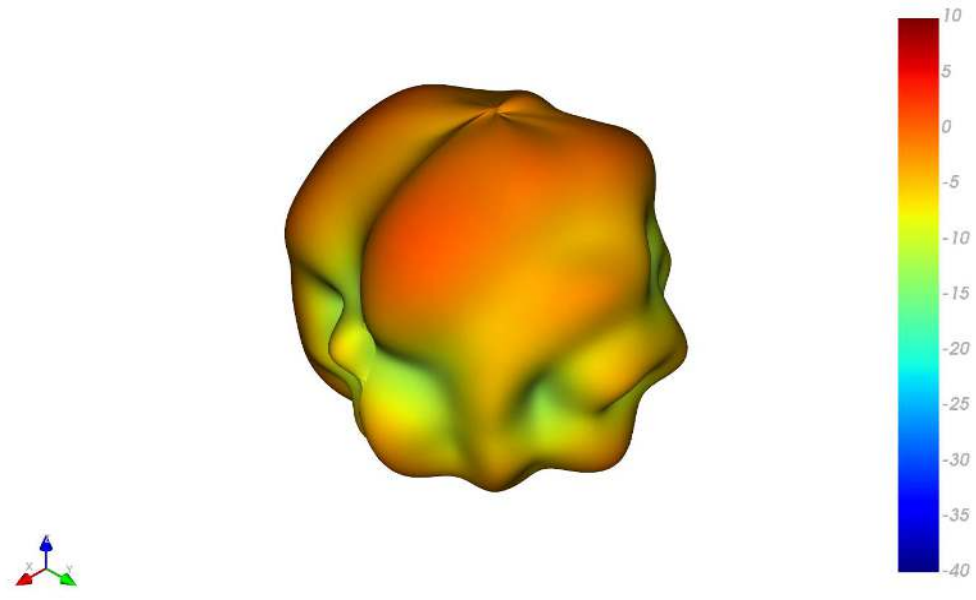

XY Plane

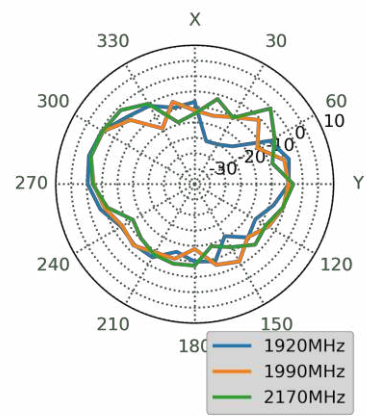

XZ Plane

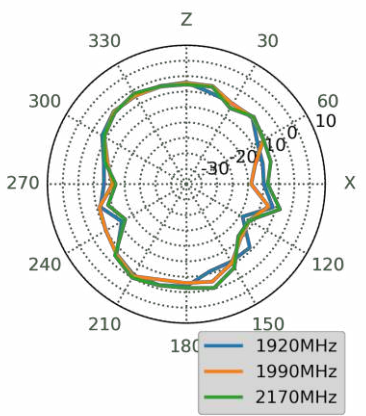

YZ Plane

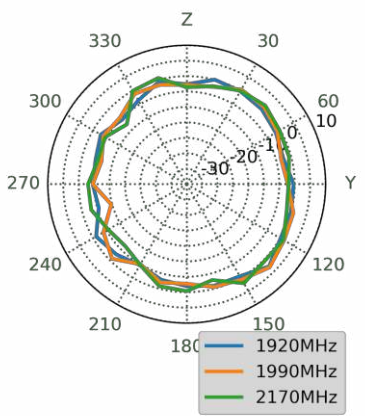

2595MHz

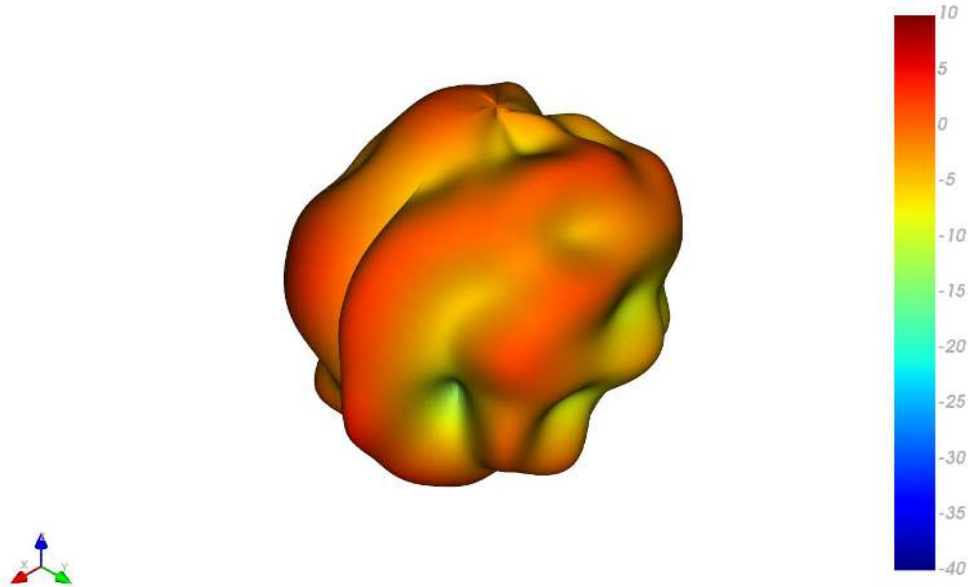

XY Plane

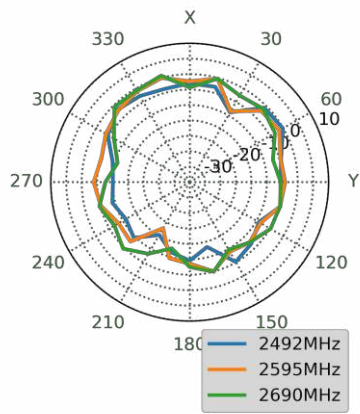

XZ Plane

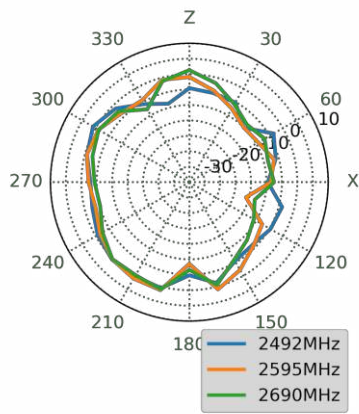

YZ Plane

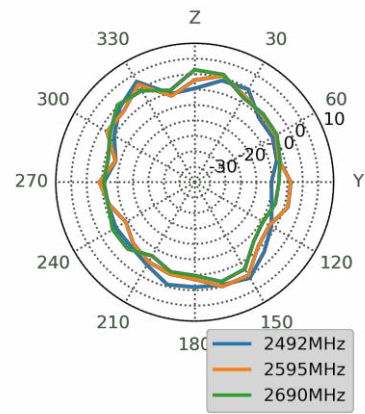

3550MHz

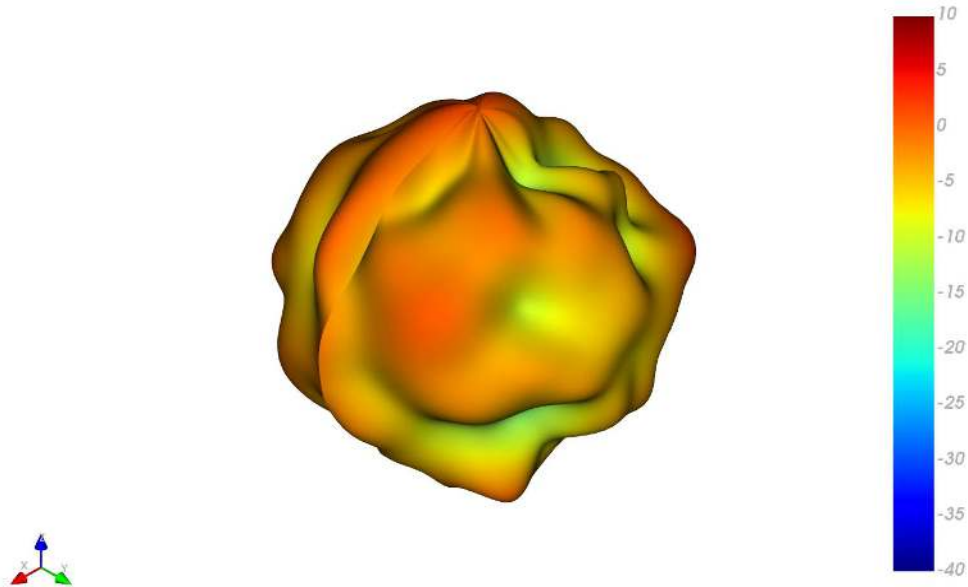

XY Plane

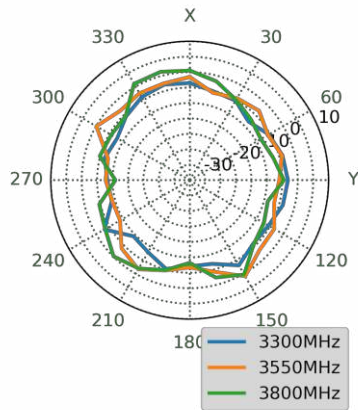

XZ Plane

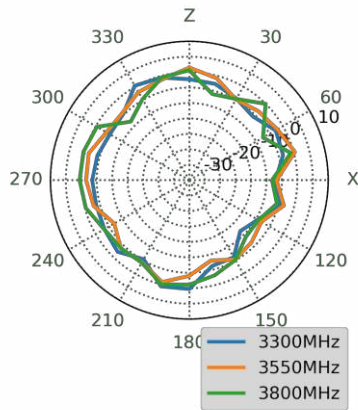

YZ Plane

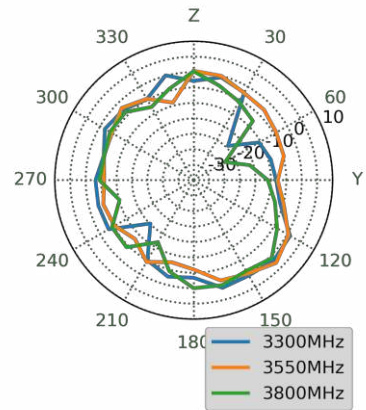

5.5 5G/4G MIMO 4 3D and 2D Radiation Patterns

652MHz

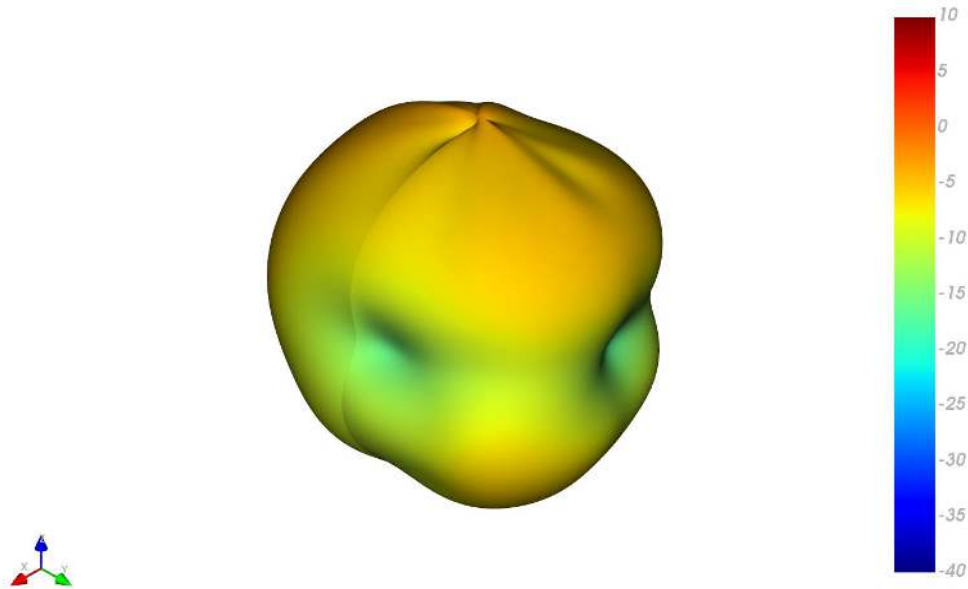

XY Plane

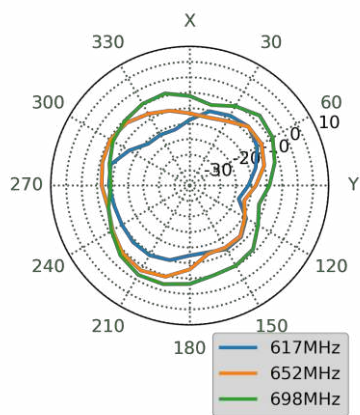

XZ Plane

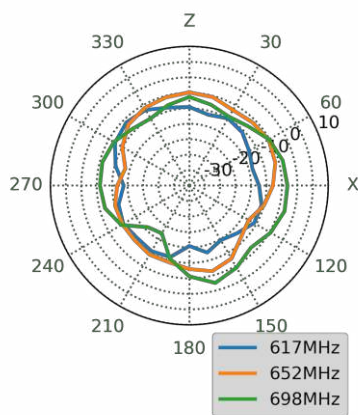

YZ Plane

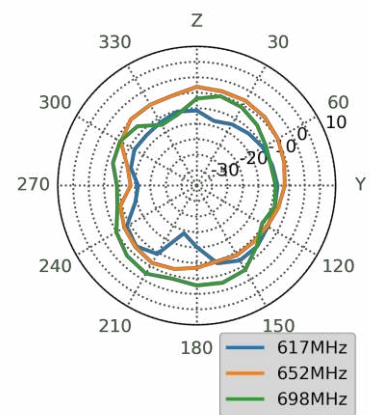

751MHz

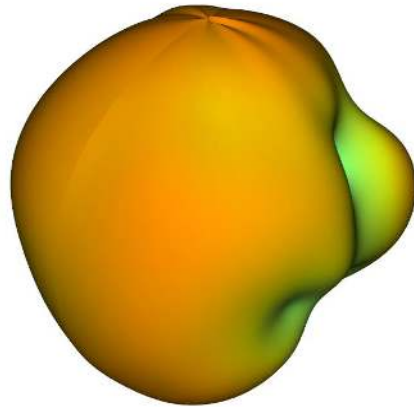

XY Plane

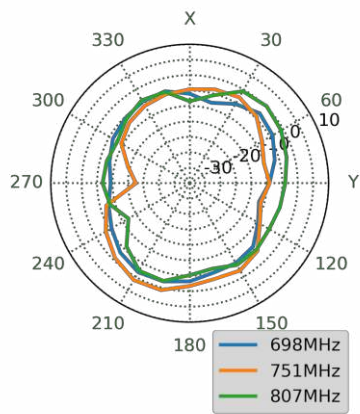

XZ Plane

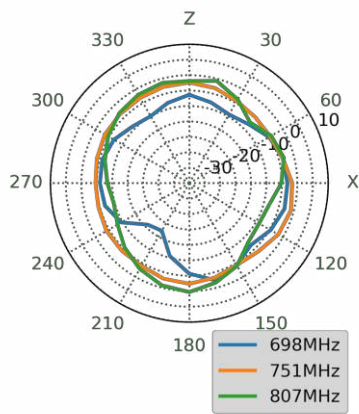

YZ Plane

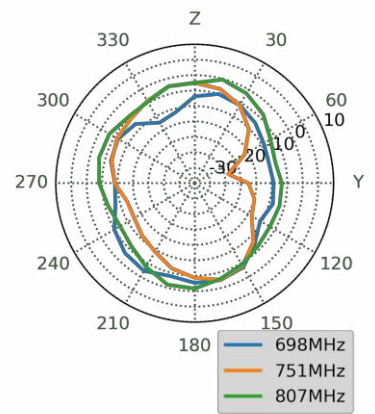

890MHz

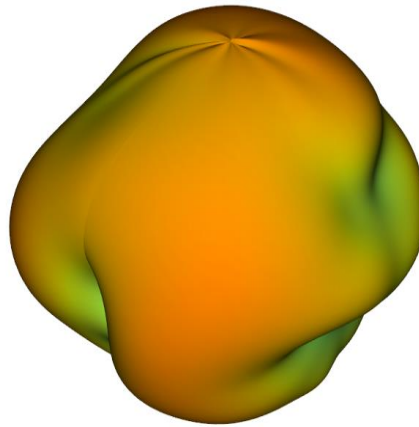

XY Plane XZ Plane YZ Plane

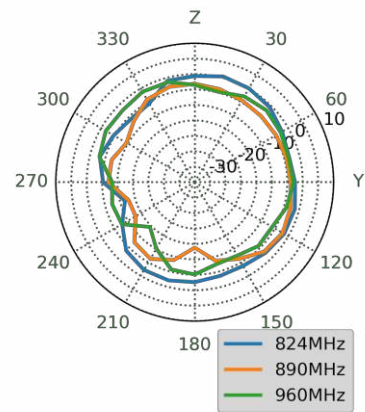
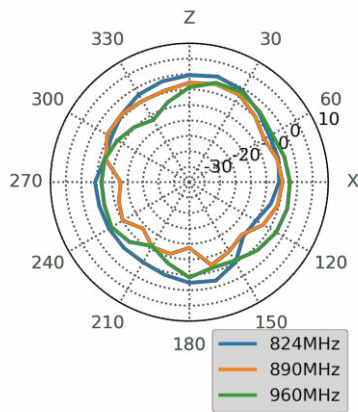
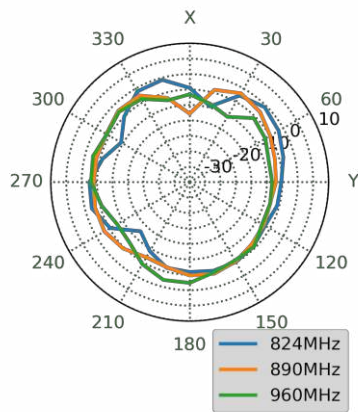

1470MHz

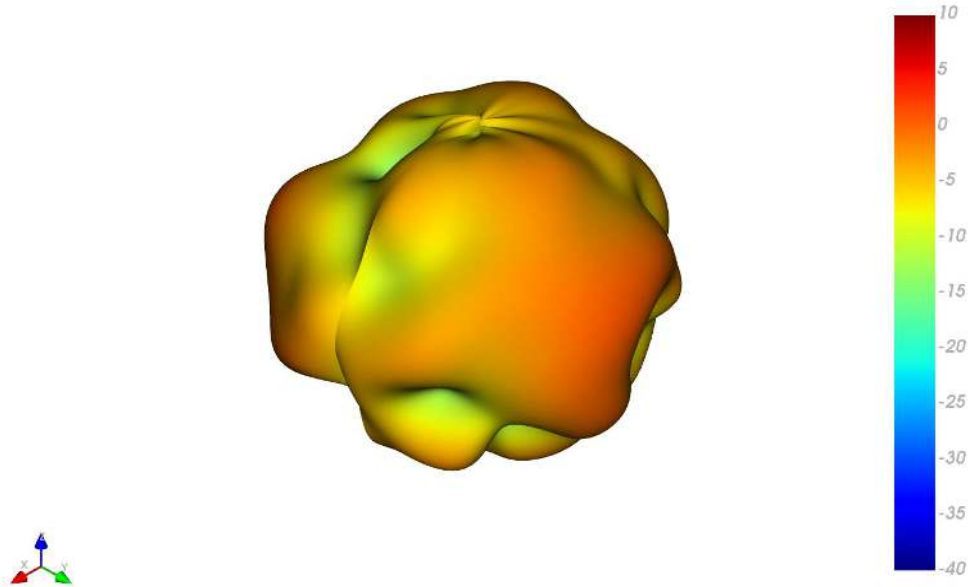

XY Plane

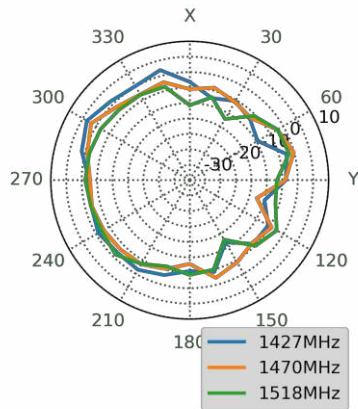

XZ Plane

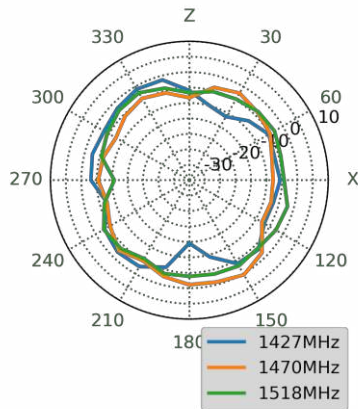

YZ Plane

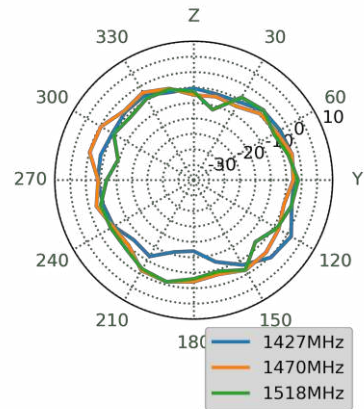

1805MHz

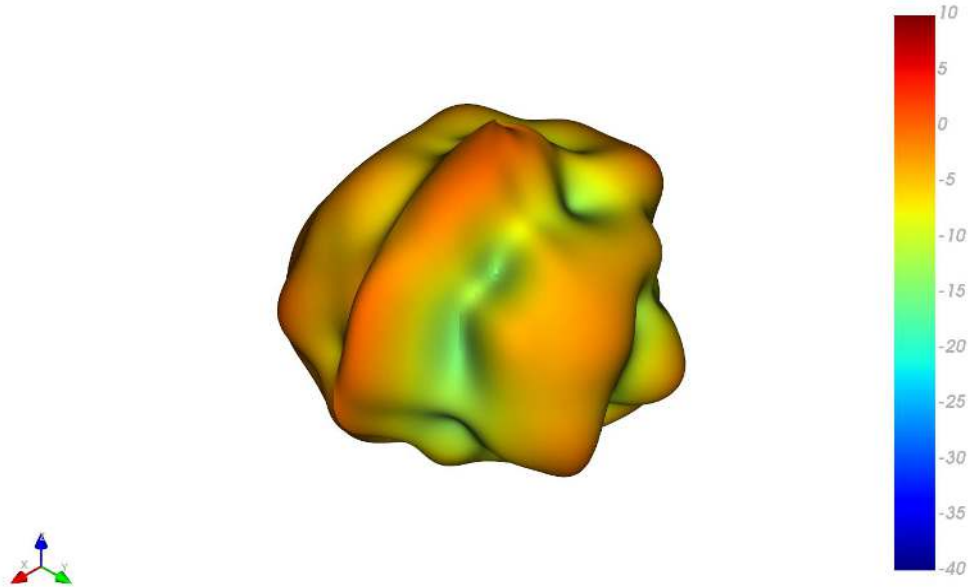

XY Plane

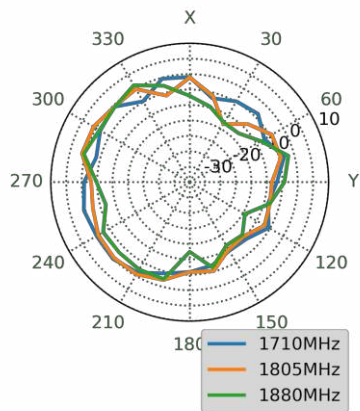

XZ Plane

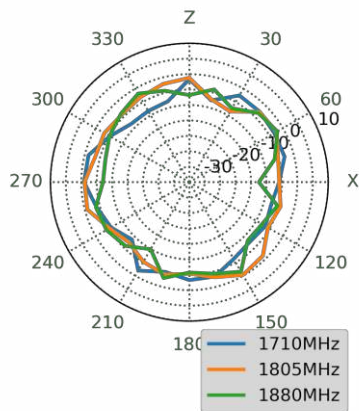

YZ Plane

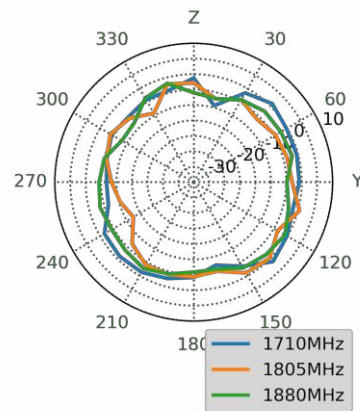

1920MHz

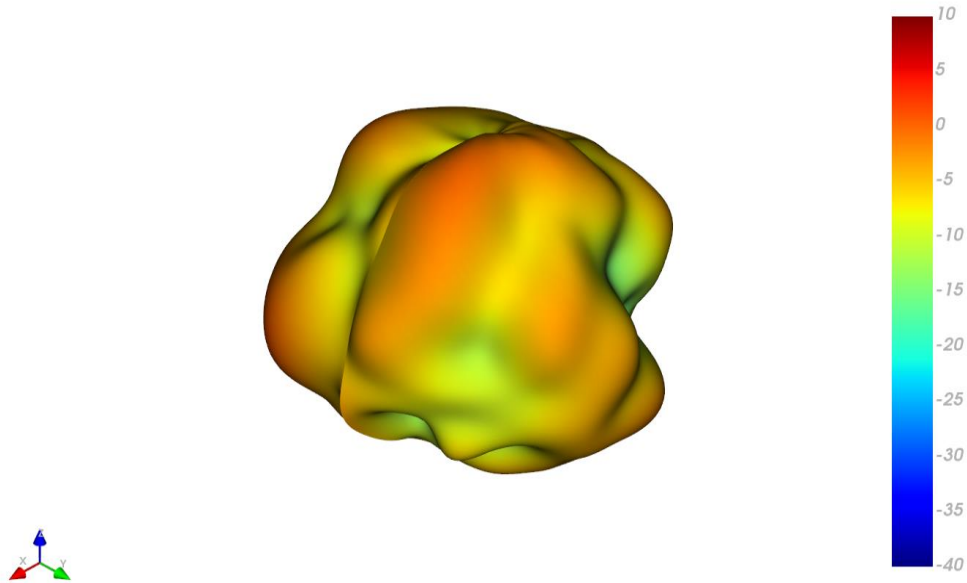

XY Plane

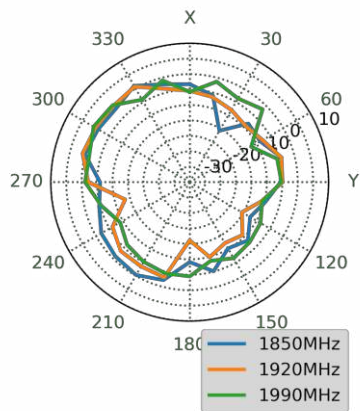

XZ Plane

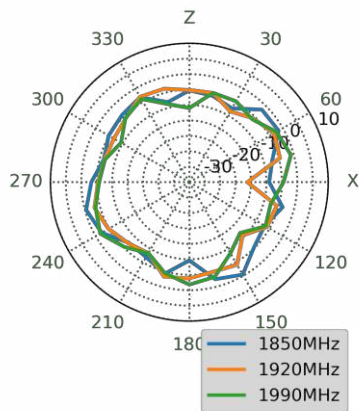

YZ Plane

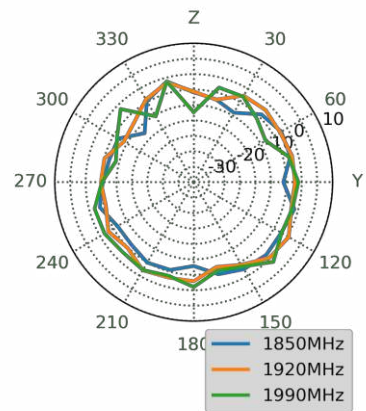

1990MHz

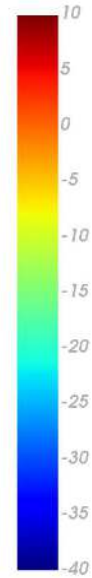
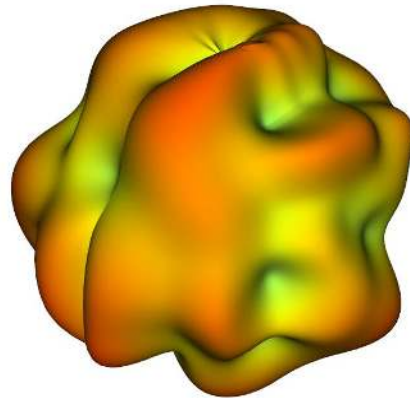

XY Plane

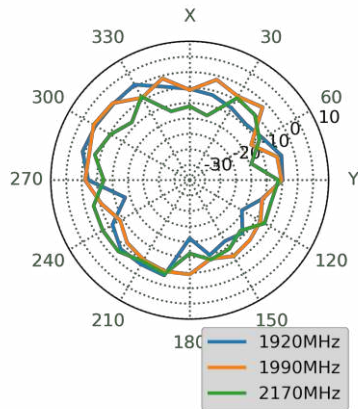

XZ Plane

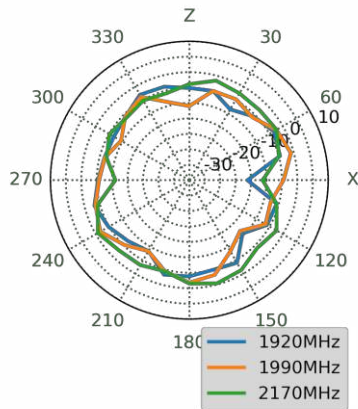

YZ Plane

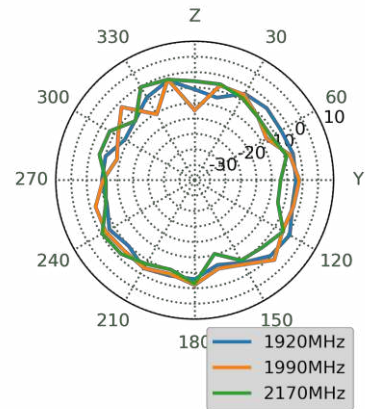

2595MHz

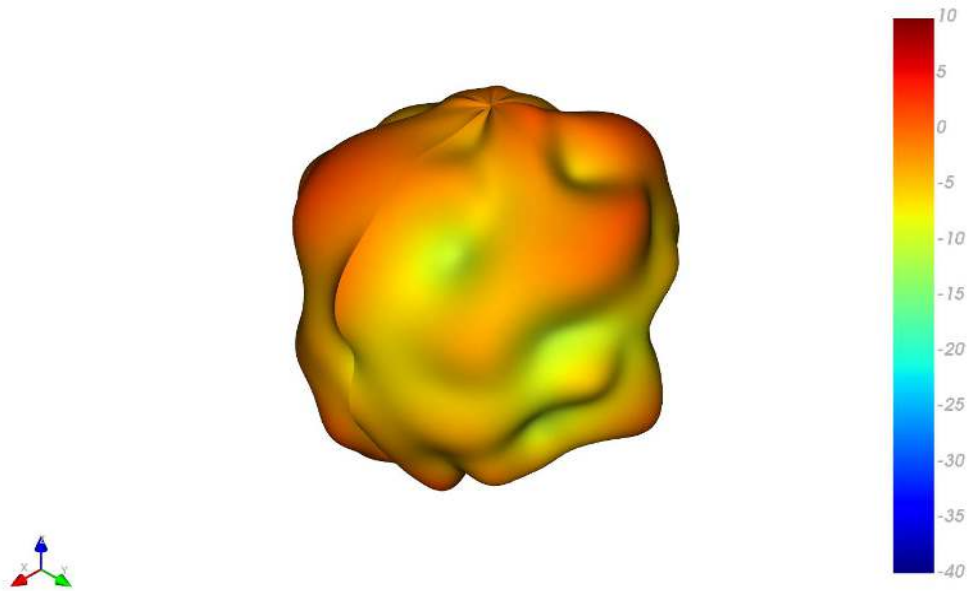

XY Plane

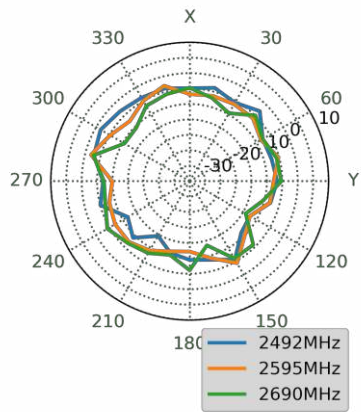

XZ Plane

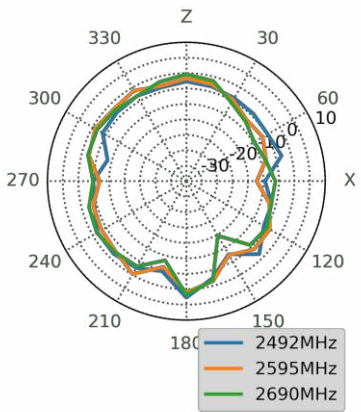

YZ Plane

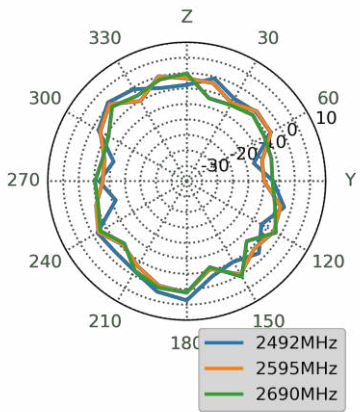

3550MHz

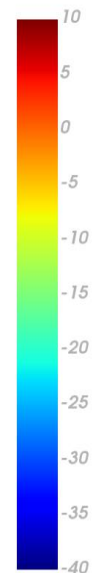
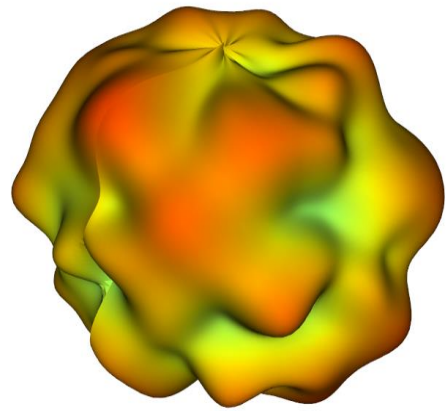

XY Plane

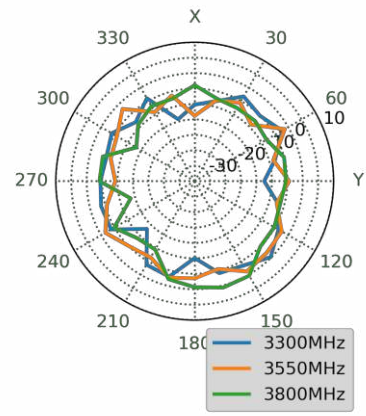

XZ Plane

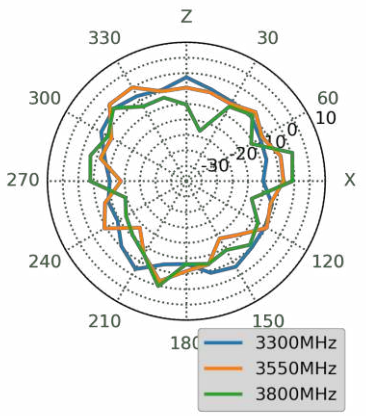

YZ Plane

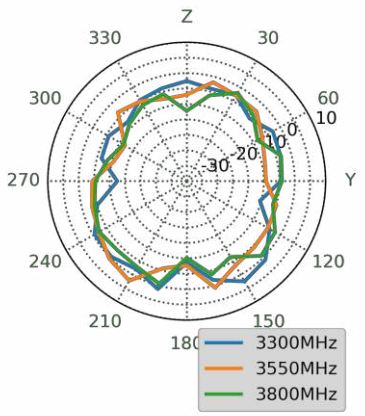

5.6 Wi-Fi MIMO 1 3D and 2D Radiation Patterns

2450MHz

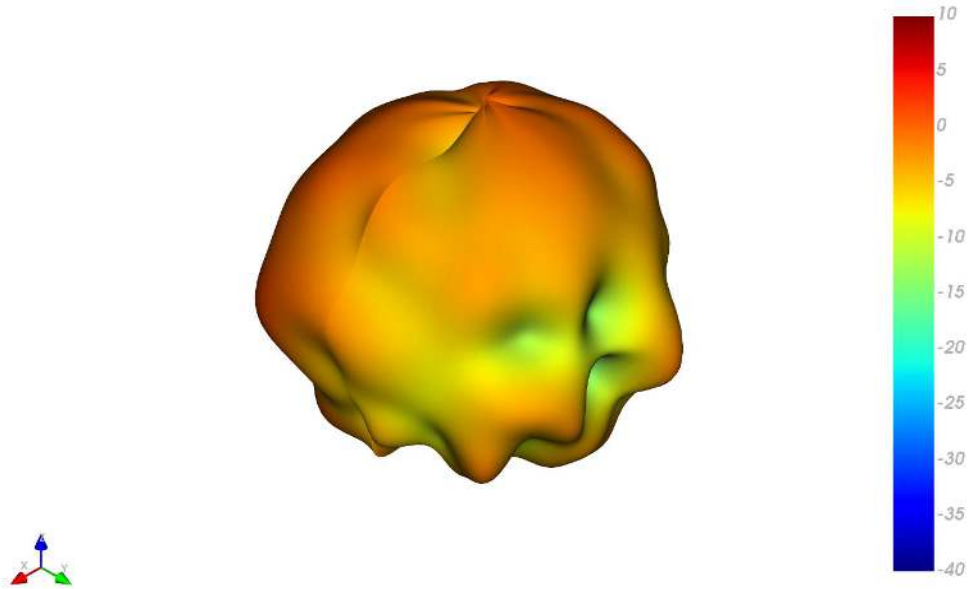

XY Plane

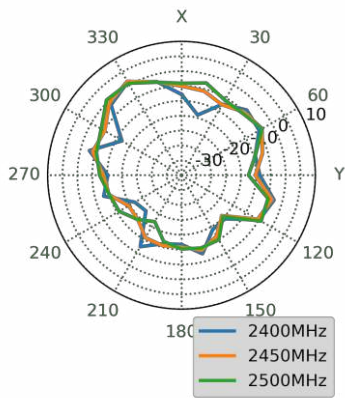

XZ Plane

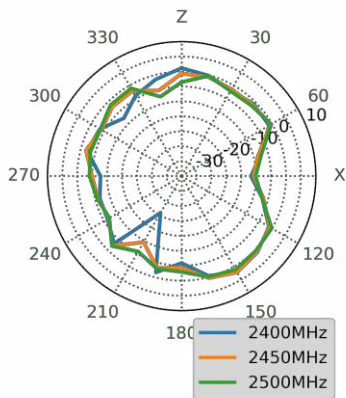

YZ Plane

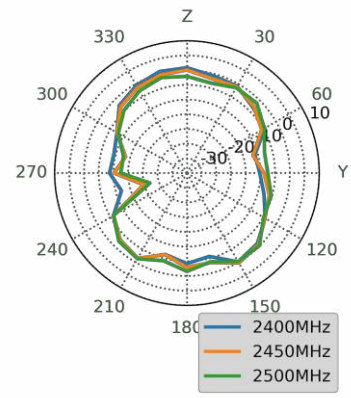

5550MHz

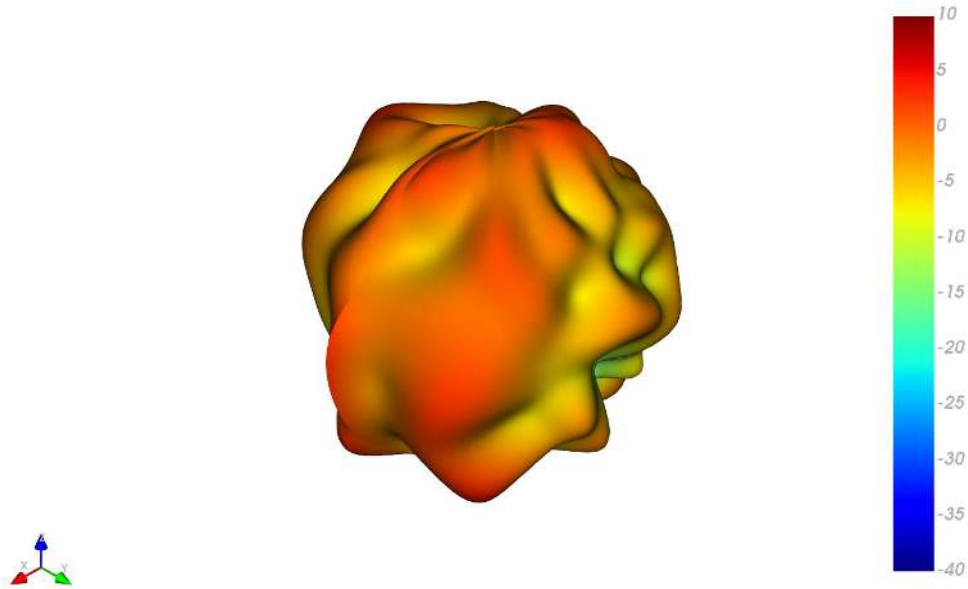

XY Plane XZ Plane YZ Plane

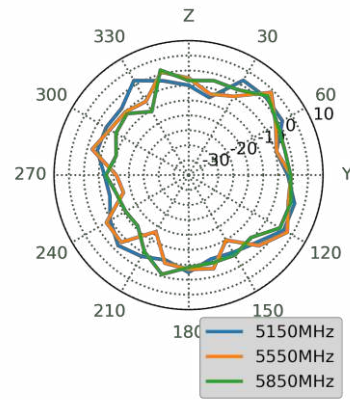
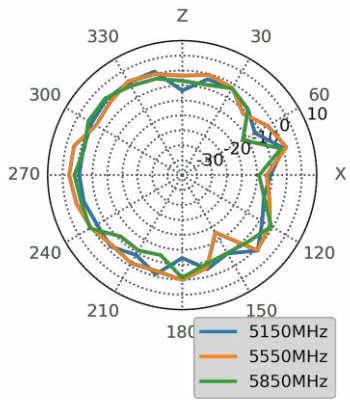
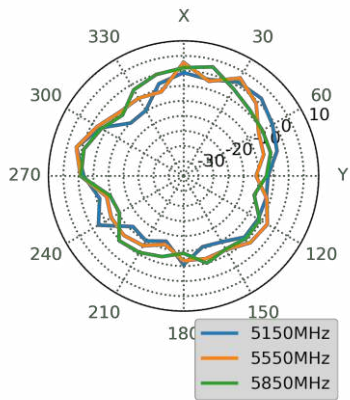

6475MHz

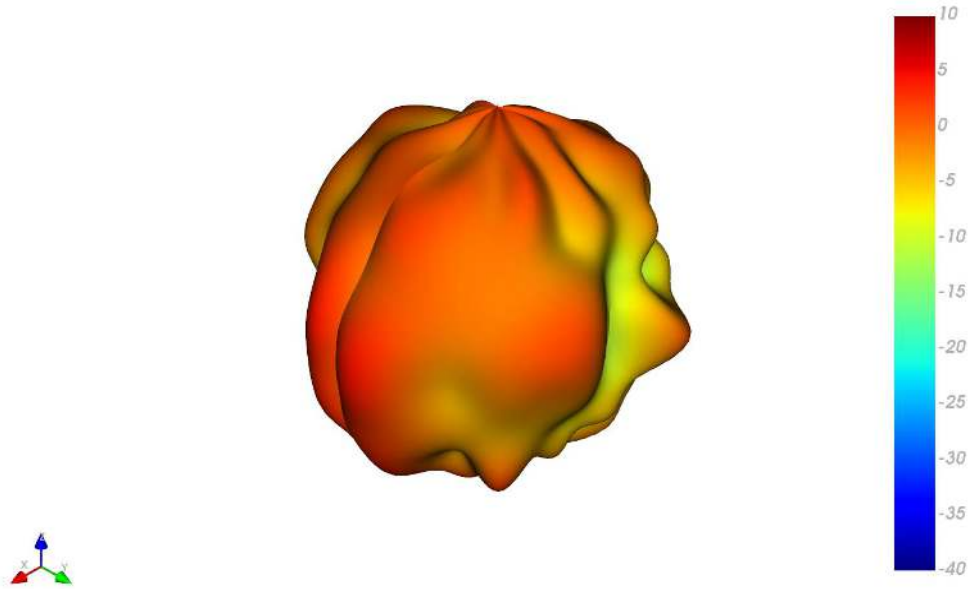

XY Plane

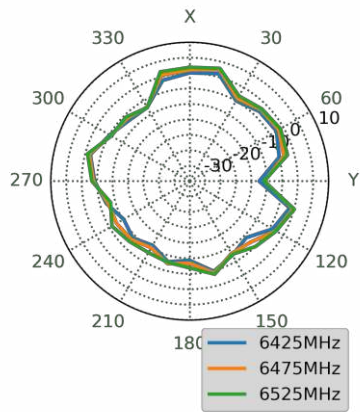

XZ Plane

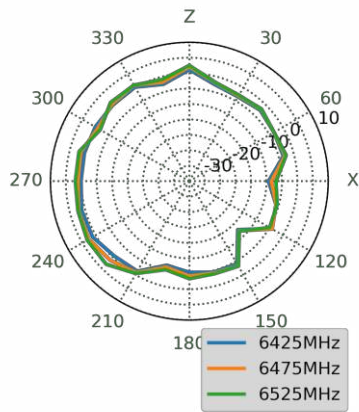

YZ Plane

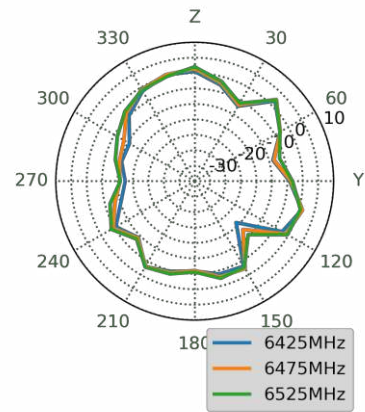

7000MHz

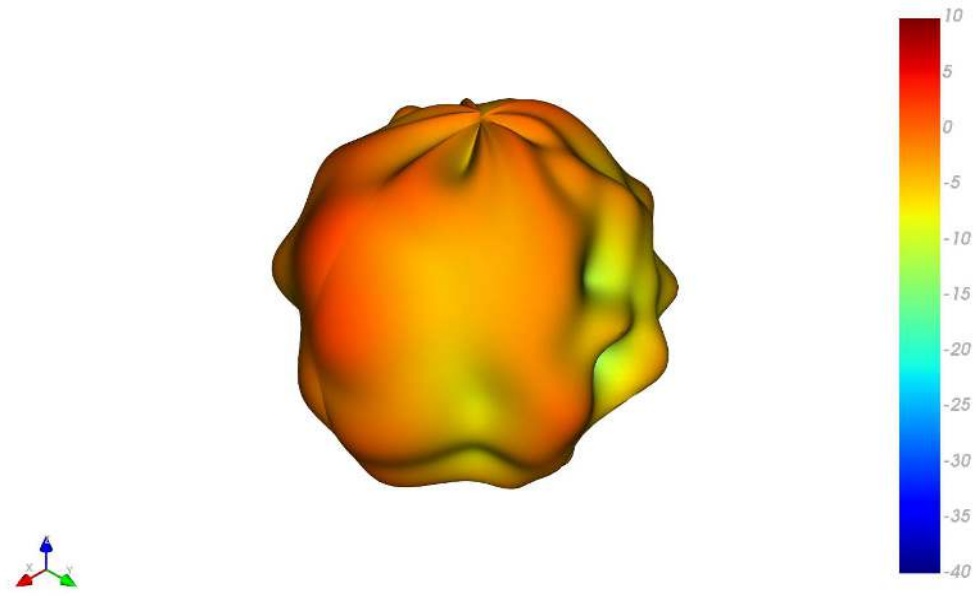

XY Plane

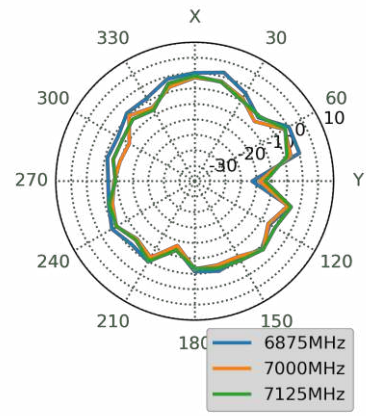

XZ Plane

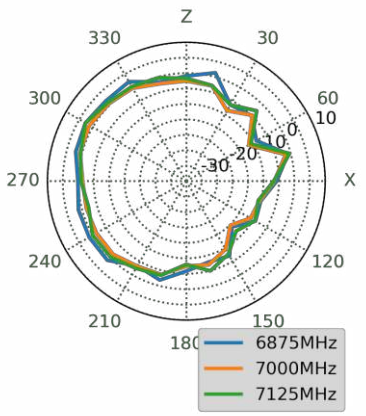

YZ Plane

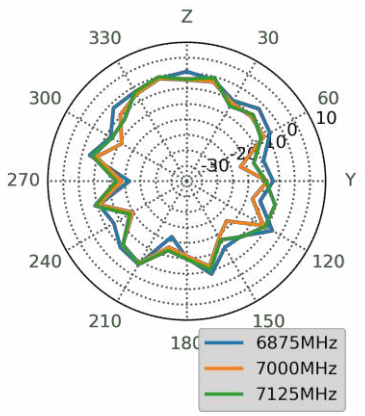

5.7 Wi-Fi MIMO 2 3D and 2D Radiation Patterns

2450MHz

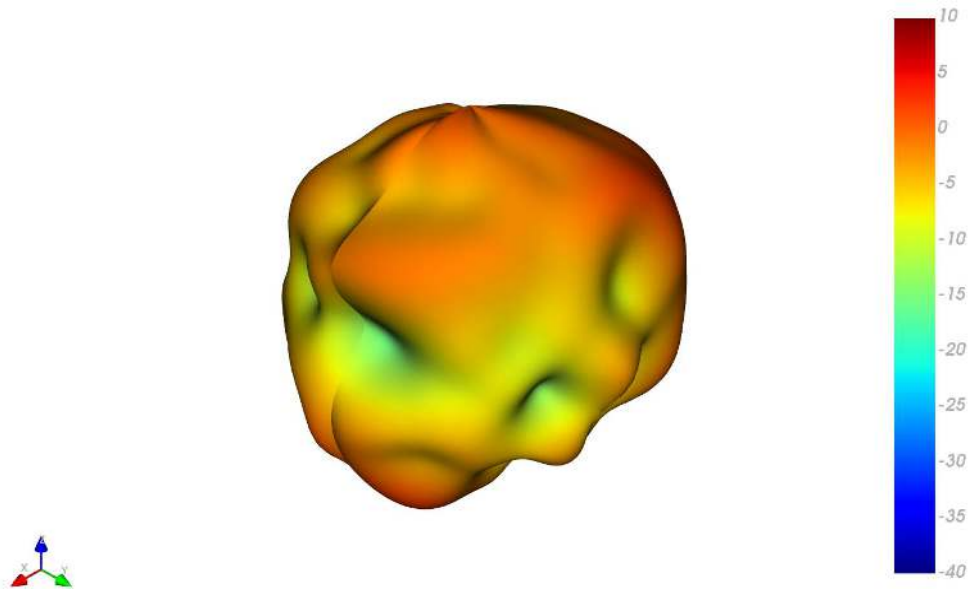

XY Plane

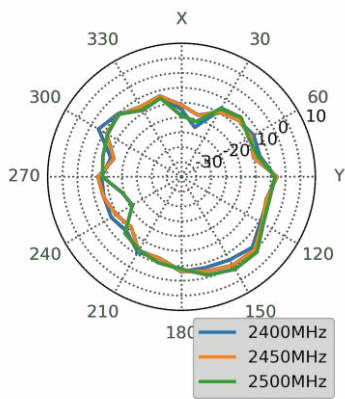

XZ Plane

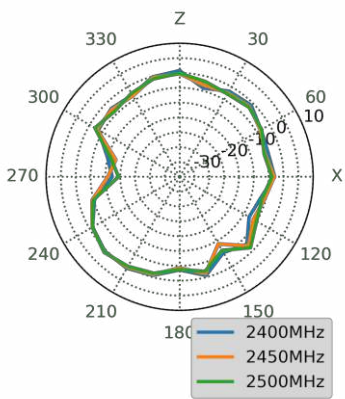

YZ Plane

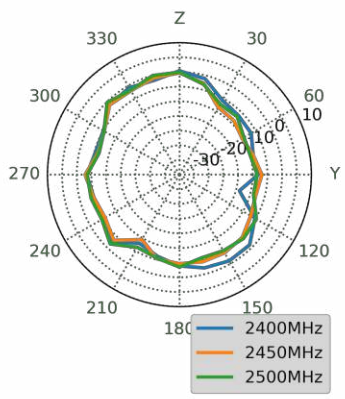

5550MHz

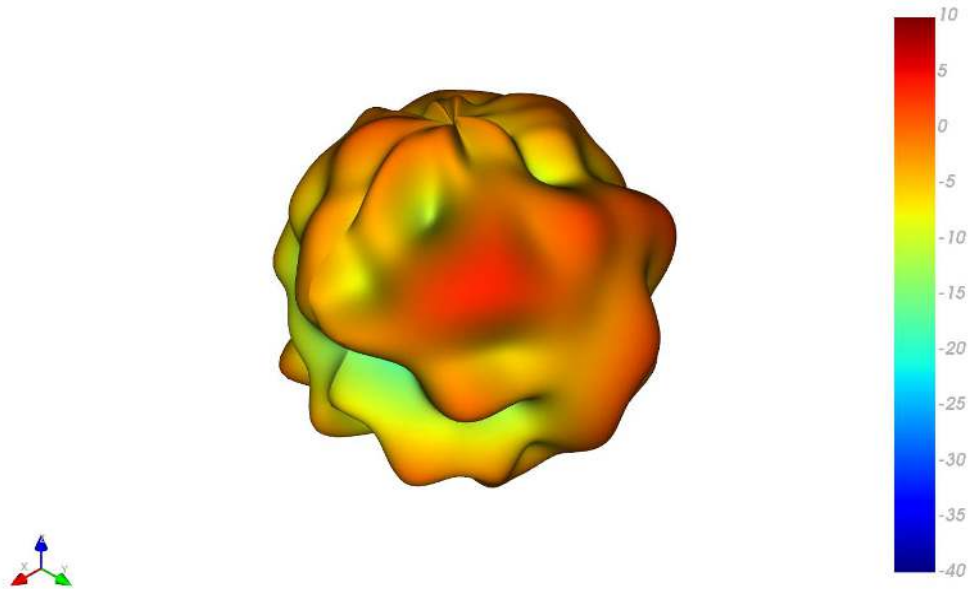

XY Plane

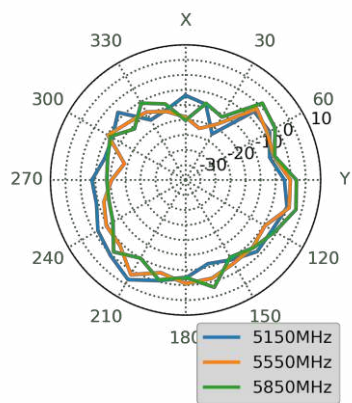

XZ Plane

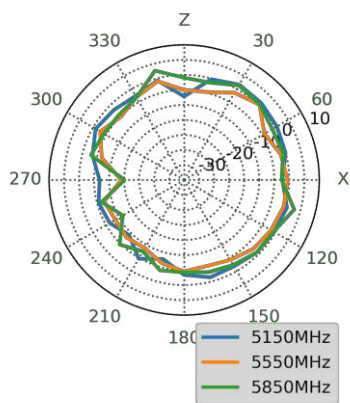

YZ Plane

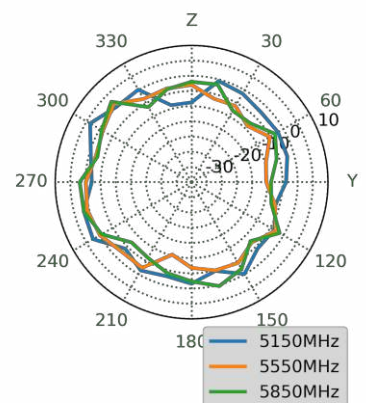

6475MHz

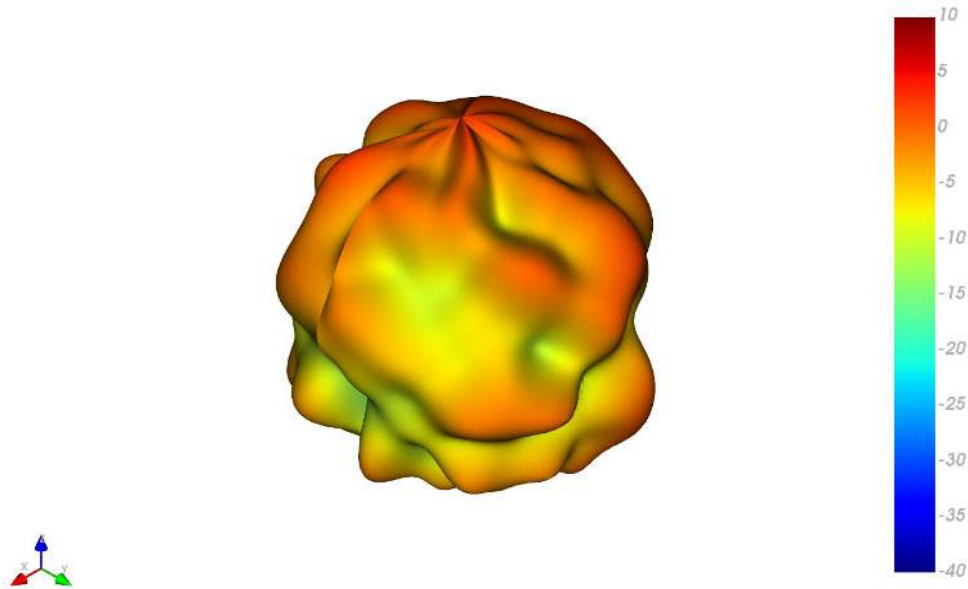

XY Plane

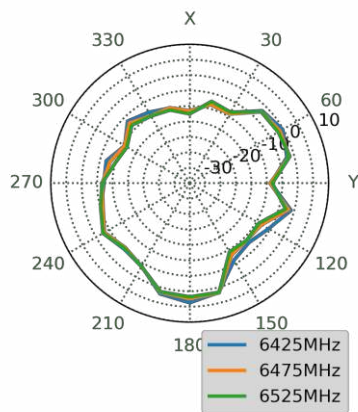

XZ Plane

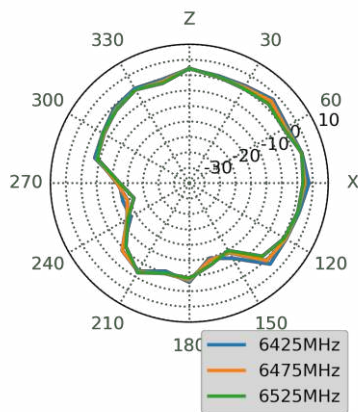

YZ Plane

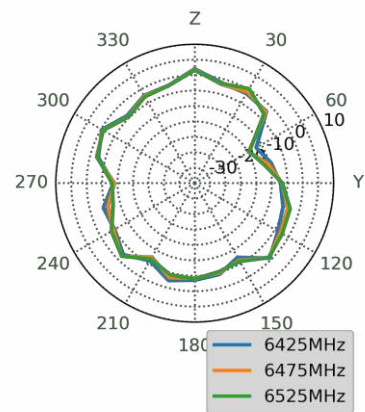

7000MHz

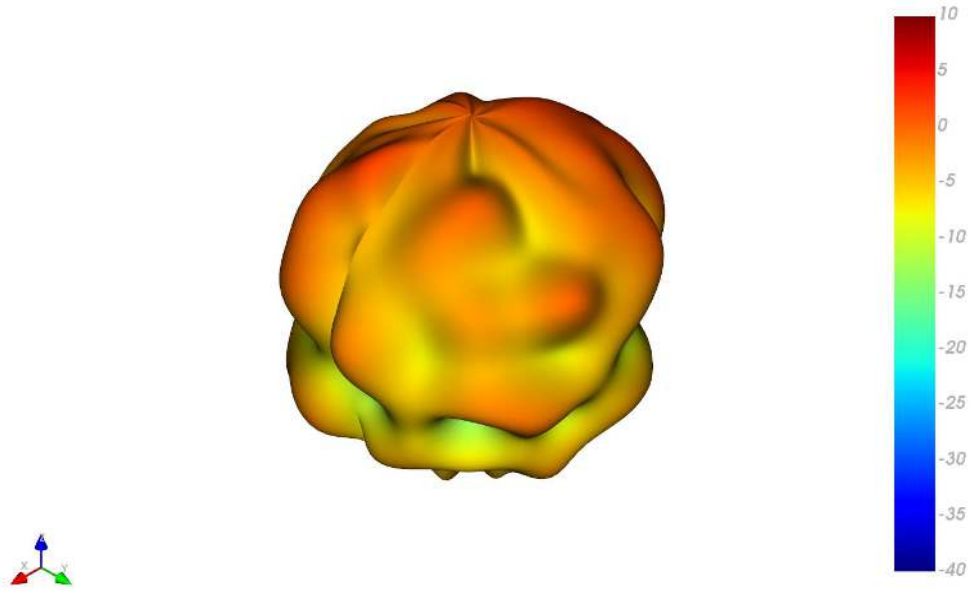

XY Plane

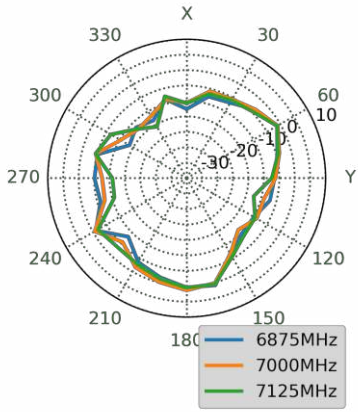

XZ Plane

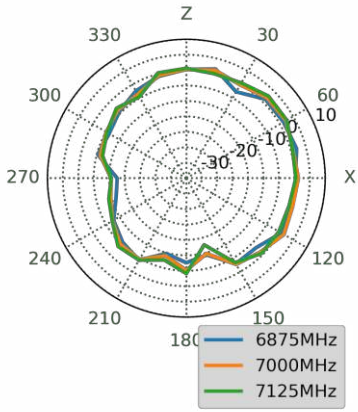

YZ Plane

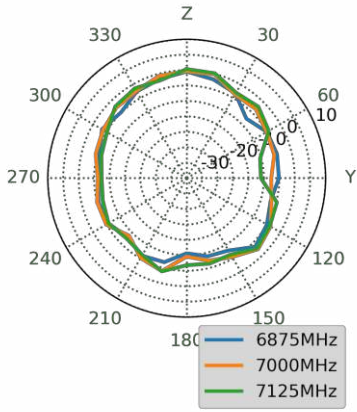

5.8 Wi-Fi MIMO 3 3D and 2D Radiation Patterns

2450MHz

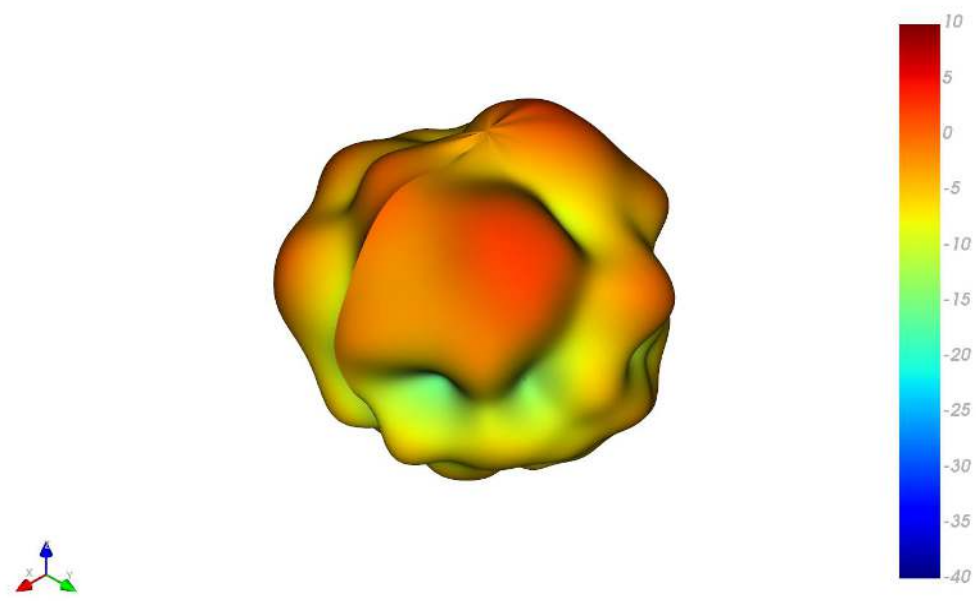

XY Plane

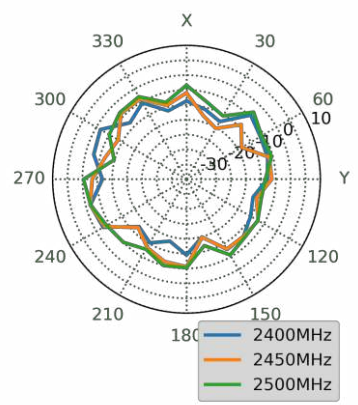

XZ Plane

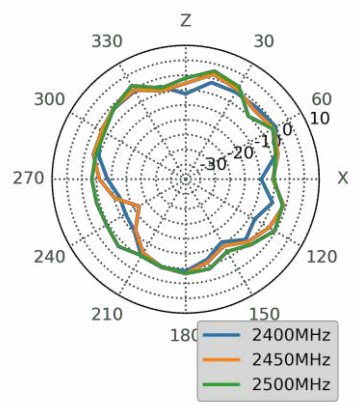

YZ Plane

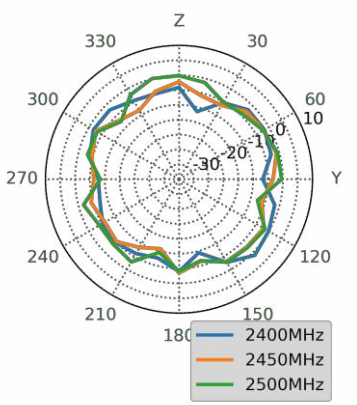

5550MHz

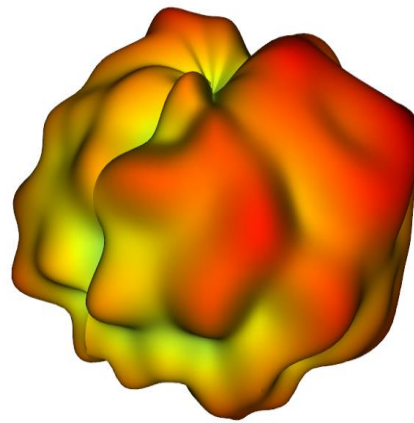

XY Plane

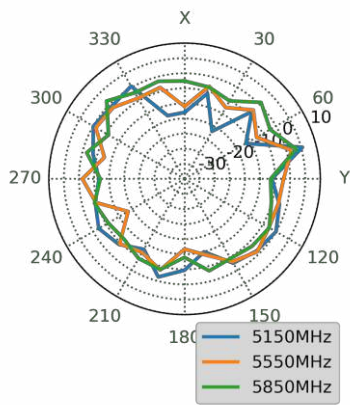

XZ Plane

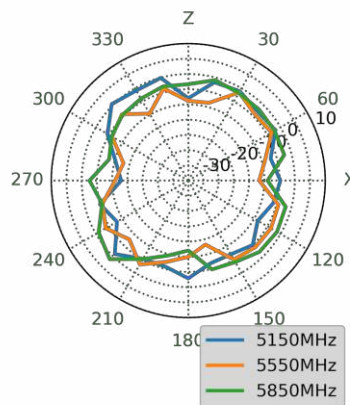

YZ Plane

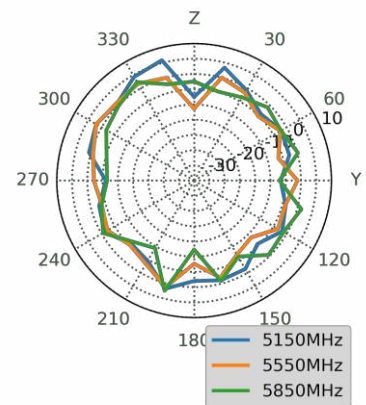

6475MHz

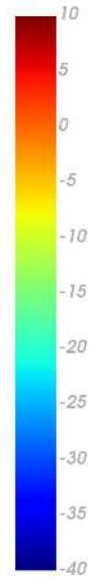
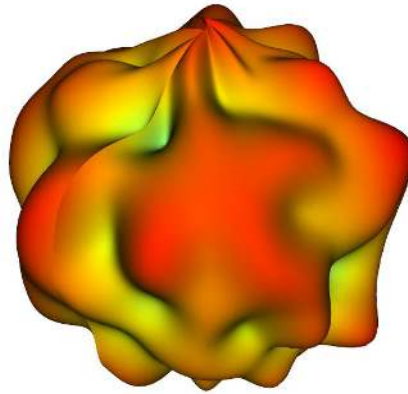

XY Plane

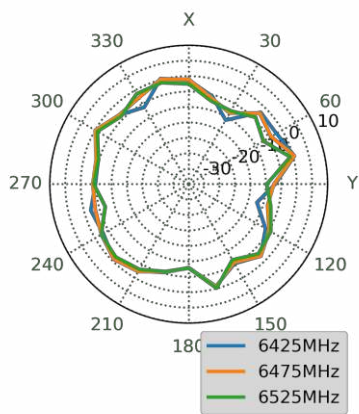

XZ Plane

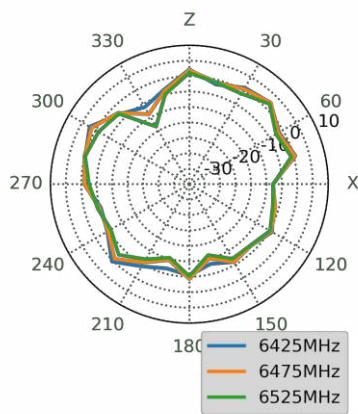

YZ Plane

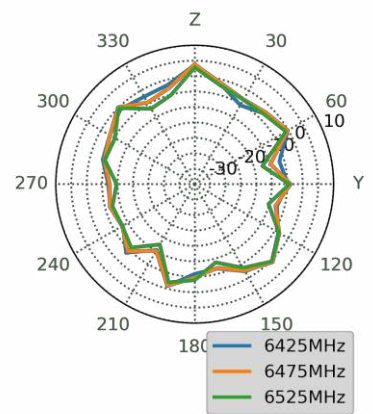

7000MHz

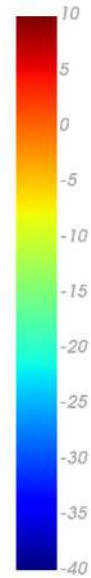
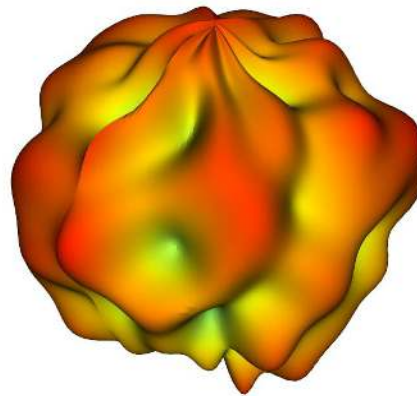

XY Plane

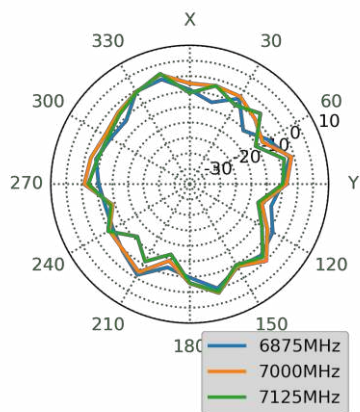

XZ Plane

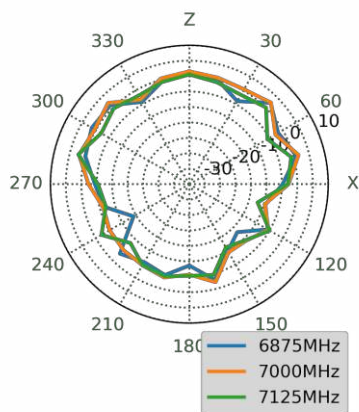

YZ Plane

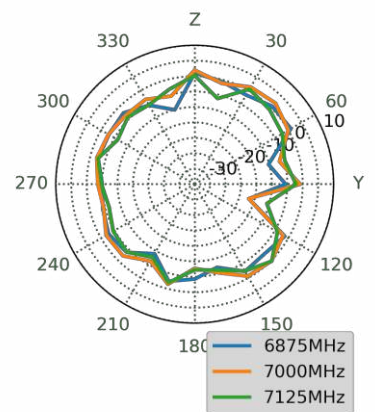

5.9 Wi-Fi MIMO 4 3D and 2D Radiation Patterns

2450MHz

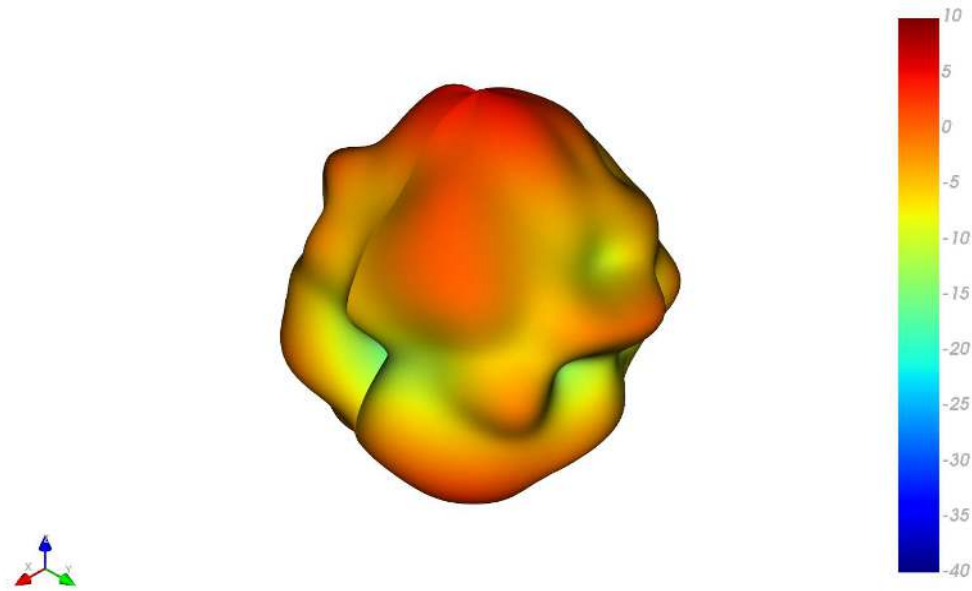

XY Plane

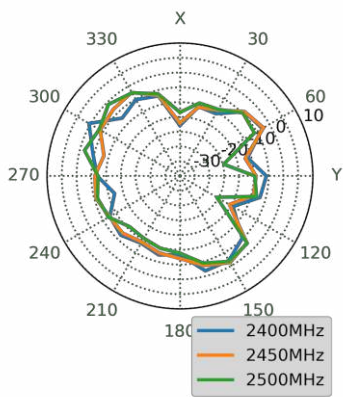

XZ Plane

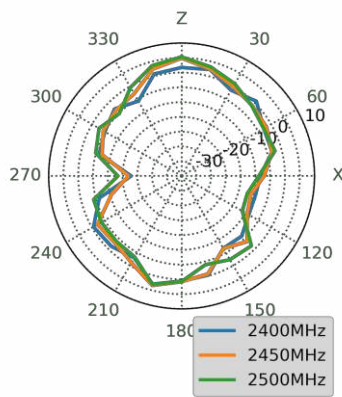

YZ Plane

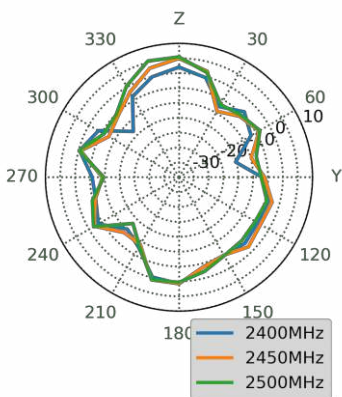

5550MHz

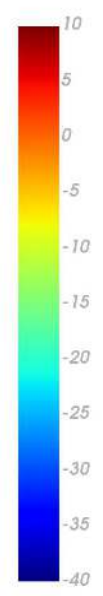
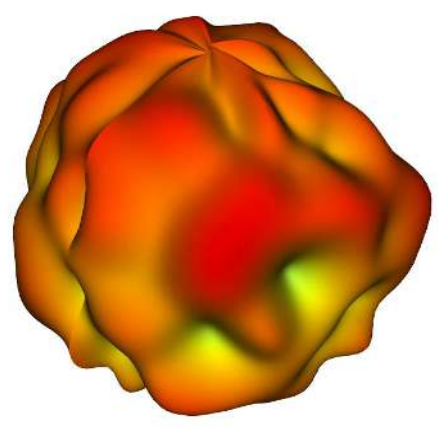

XY Plane

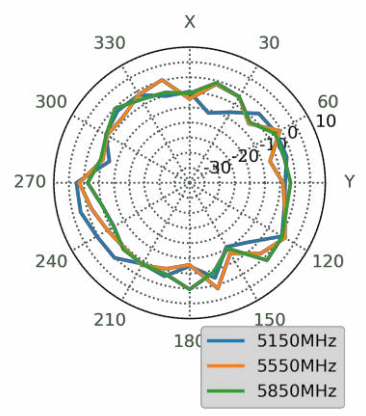

XZ Plane

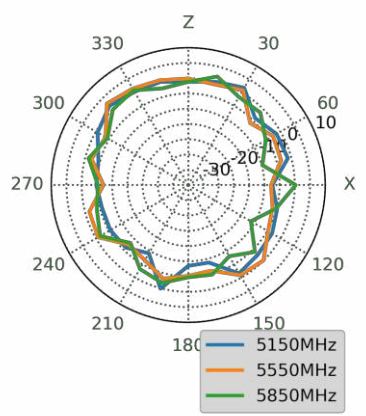

YZ Plane

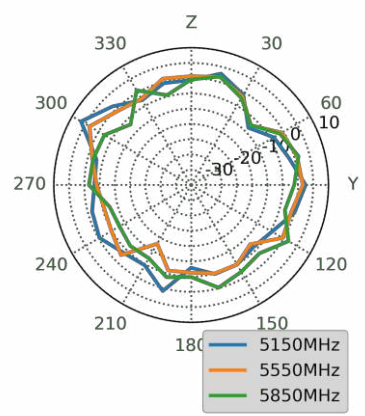

6475MHz

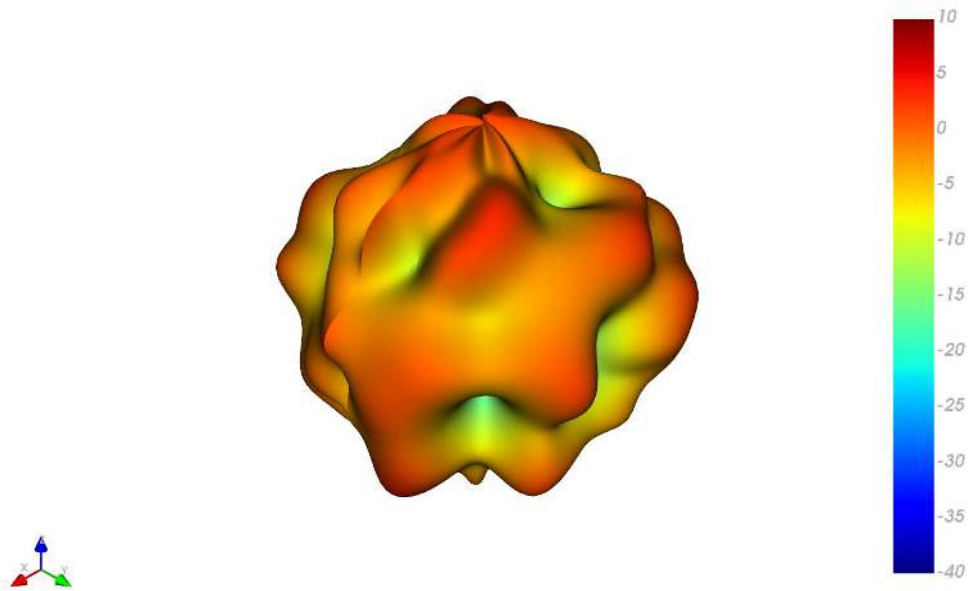

XY Plane

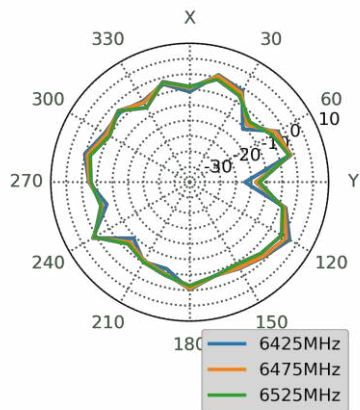

XZ Plane

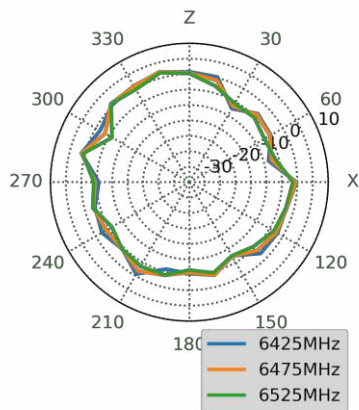

YZ Plane

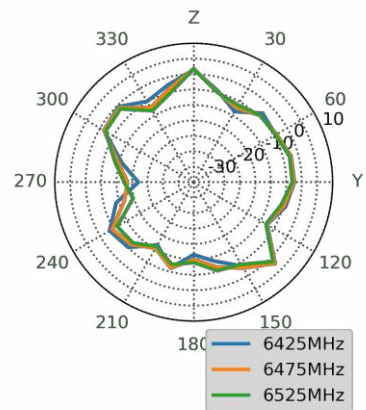

7000MHz

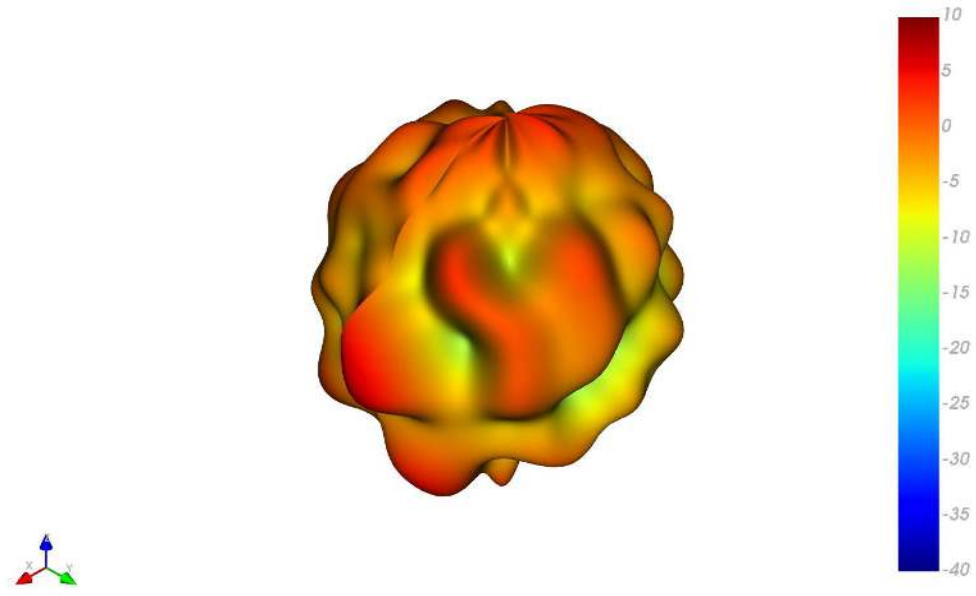

XY Plane

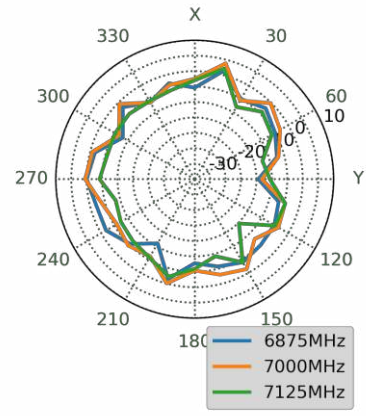

XZ Plane

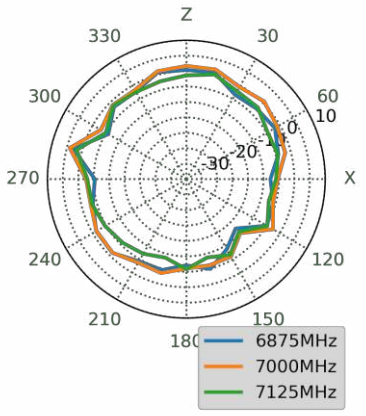

YZ Plane

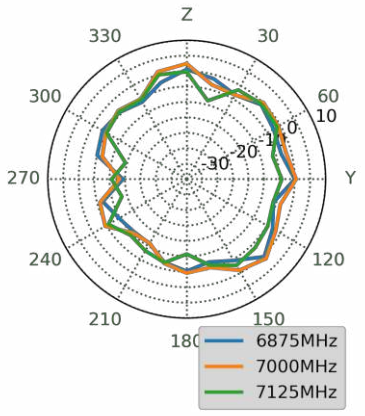

6. Mechanical Drawing (Units: mm)

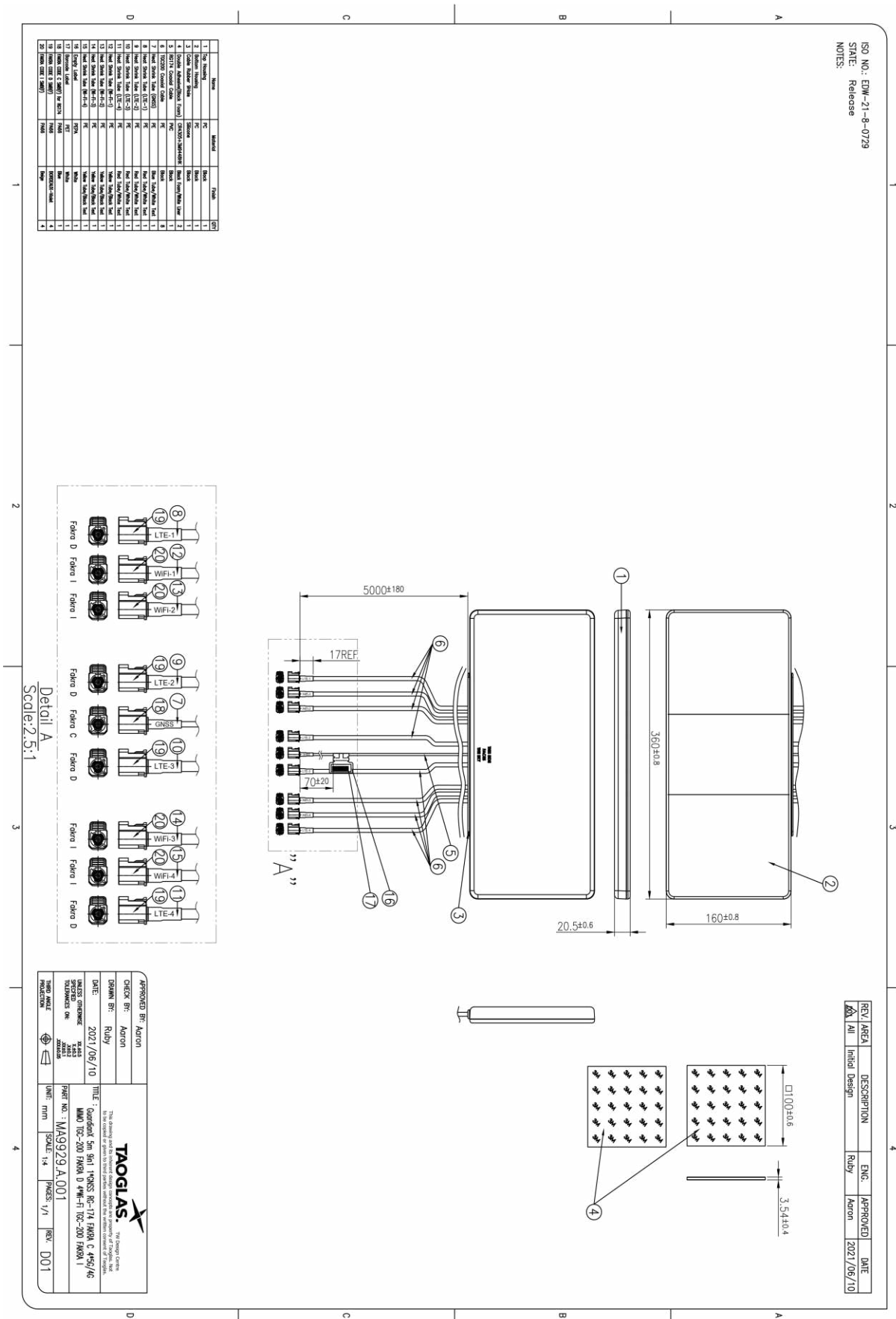

7. Packaging

1pc MA9929.A.001 Per PE Bag
 Bag Dimensions – 364*524mm
 Weight – 1.068Kg

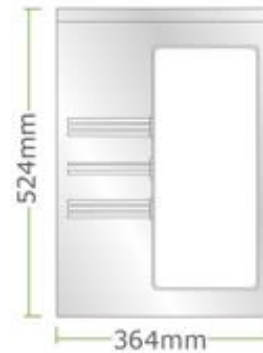

10pcs MA9929.A.001 Per Carton
 Carton Dimensions – 430*380*280mm
 Weight – 11.6Kg

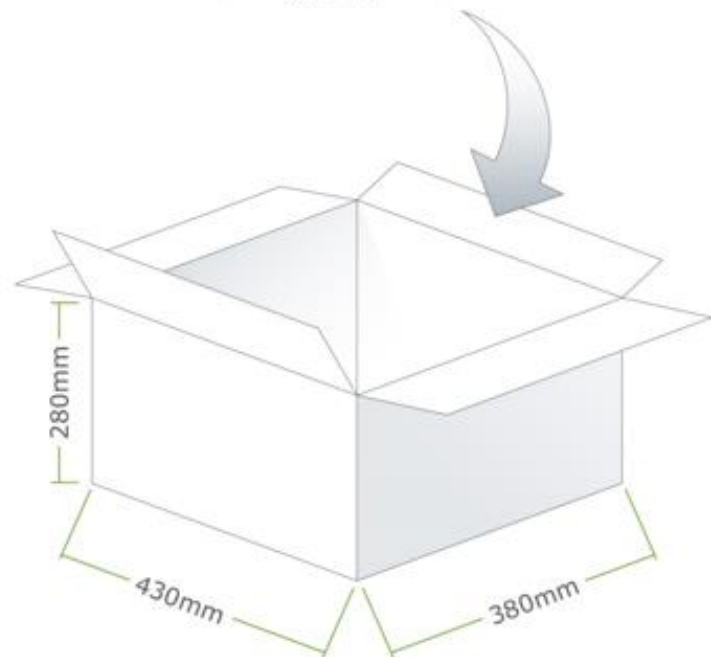

Pallet Dimensions:
 1200mm * 1000mm 1280mm
 24 Cartons Per Pallet
 6 Cartons Per Layer, 4 Layers

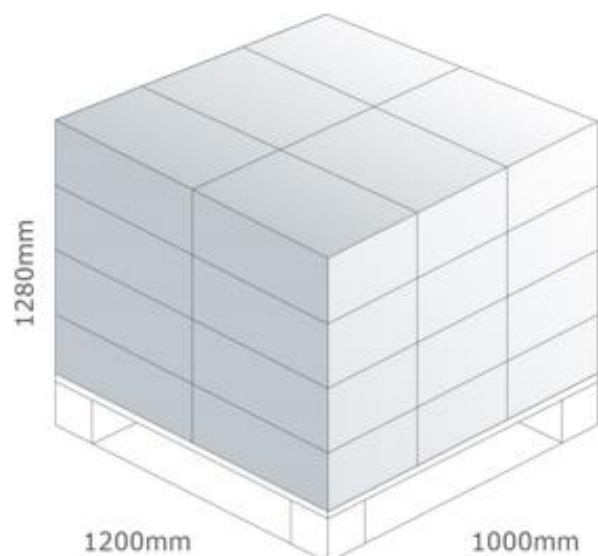

Changelog for the datasheet

SPE-21-8-069– MA9929.A.001

Revision: A (Original First Release)

Date:	2021-08-19
Notes:	Custom Datasheet New Release
Author:	Gary West

Previous Revisions



www.taoglas.com

