

### Hybrid IC IGBT Gate Driver

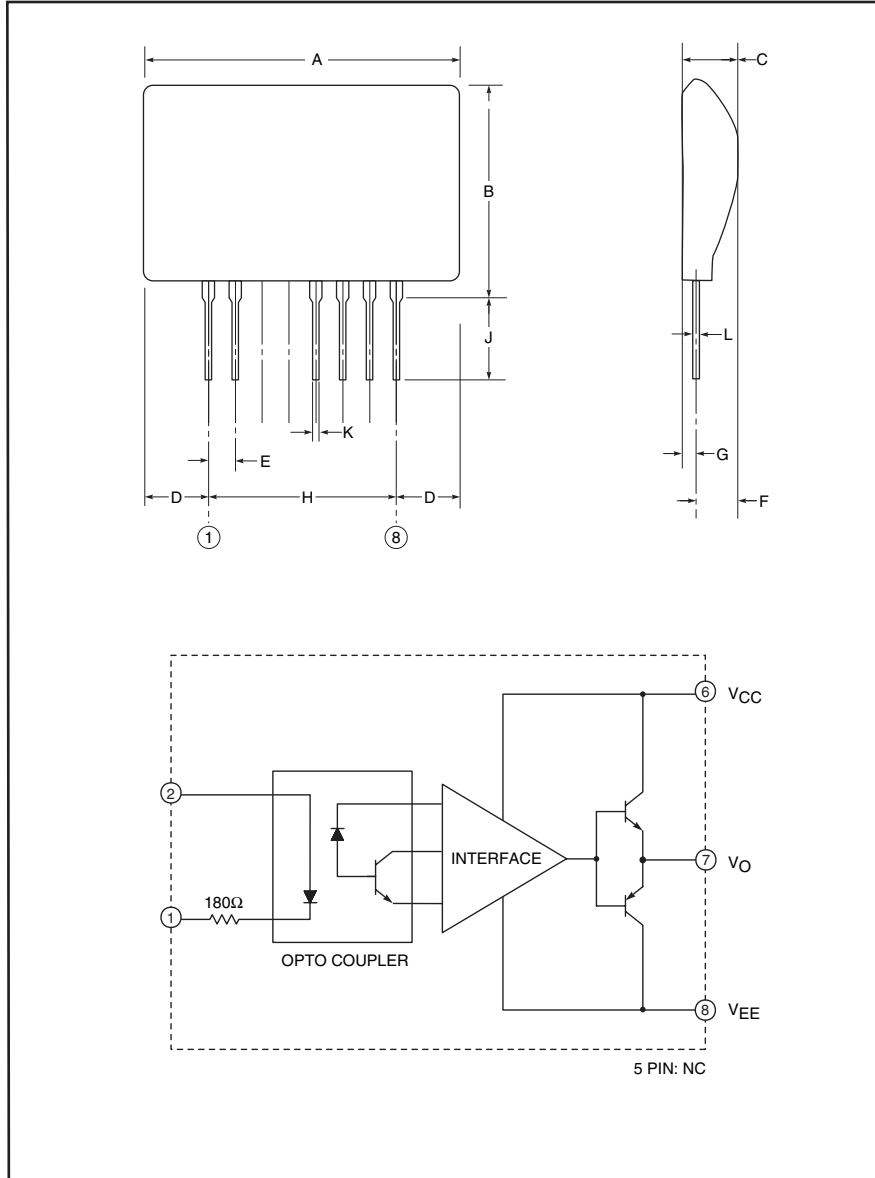

Outline Drawing and Circuit Diagram

Dimensions	Inches	Millimeters
A	1.18 Max.	30.0 Max.
B	0.79 Max.	20.0 Max.
C	0.28 Max.	7.0 Max.
D	0.24 Max.	6.0 Max.
E	0.10	2.54
F	2.16 Max.	5.5 Max.
G	0.08 Max.	2.0 Max.
H	0.70	17.78
J	0.18±0.06	4.5±1.5
K	0.02	0.5
L	0.01	0.25

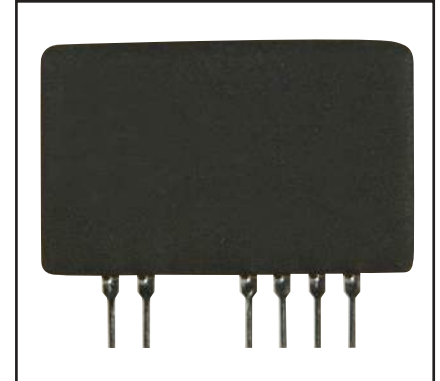

#### Description:

VLA507-01 is a hybrid integrated circuit designed for driving IGBT modules. This device operates as an isolation amplifier for these modules and provides the required electrical isolation between the input and output with an opto-coupler.

#### Features:

- Output is ±3 Amperes Maximum
- Two Supply Drive (VCC: 15 Volts, VEE: -10 Volts)
- SIP Outline Allows More Space on Mounting Area
- Electrical Isolation Voltage Between Input and Output (2500 V<sub>rms</sub> for 1 Minute)
- TTL Compatible Input

#### Application:

To drive IGBT modules for welding, induction heating, or inverters.

#### Recommended IGBT Modules:

NFH Series IGBTs –  
V<sub>CES</sub> = 1200V up to  
150A class (f: up to 30kHz)

NF Series IGBTs –  
V<sub>CES</sub> = 600V up to  
200A class (f: up to 20kHz)

V<sub>CES</sub> = 1200V up to  
150A class (f: up to 20kHz)



Powerex, Inc., 200 E. Hillis Street, Youngwood, Pennsylvania 15697-1800 (724) 925-7272

VLA507-01  
Hybrid IC IGBT Gate Driver

### Absolute Maximum Ratings, $T_a = 25^\circ\text{C}$ unless otherwise specified

Characteristics	Symbol	VLA507-01	Units
Supply Voltage, DC	$V_{CC}$	18	Volts
	$V_{EE}$	-12	Volts
Input Signal Voltage (Applied between Pin 1 - 2, 50% Duty Cycle, Pulse Width 1ms)	$V_i$	-1 ~ 7	Volts
Output Voltage (When the Output Voltage is "H")	$V_O$	$V_{CC}$	Volts
Output Current (Pulse Width 2 $\mu$ s, $f \leq 20\text{kHz}$ )	$I_{OHP}$	-3	Amperes
	$I_{OLP}$	3	Amperes
Isolation Voltage (Sine Wave Voltage 60HZ, for 1 Minute)	$V_{ISO}$	2500	$V_{rms}$
Case Temperature	$T_C$	85	$^\circ\text{C}$
Operating Temperature (No Condensation Allowable)	$T_{opr}$	-20 to 70	$^\circ\text{C}$
Storage Temperature (No Condensation Allowable)	$T_{stg}$	-25 to 100*	$^\circ\text{C}$

\*Differs from H/C condition.

### Electrical and Mechanical Characteristics, $T_a = 25^\circ\text{C}$ unless otherwise specified, $V_{CC} = 15\text{V}$ , $V_{EE} = -10\text{V}$ , $R_G = 9\Omega$

Characteristics	Symbol	Test Conditions	Min.	Typ.	Max.	Units
Supply Voltage	$V_{CC}$	Recommended Range	14	15	—	Volts
	$V_{EE}$	Recommended Range	-5	-8	-10	Volts
Pull-up Voltage on Primary Side	$V_{IN}$	Recommended Range	4.75	5	5.25	Volts
"H" Input Current	$I_{IH}$	Recommended Range	15.2	16.0	19.0	mA
Switching Frequency	$f$	Recommended Range	—	—	30	kHz
Gate Resistance	$R_G$	Recommended Range	3.9	—	—	$\Omega$
"H" Input Current	$I_{IH}$	$V_{IN} = 5\text{V}$	—	16	—	mA
"H" Output Voltage	$V_{OH}$	—	13	14	—	Volts
"L" Output Voltage	$V_{OL}$	—	-8	-9	—	Volts
"L-H" Propagation Time	$t_{PLH}$	$I_{IH} = 16\text{mA}$	—	0.4	0.8	$\mu\text{s}$
"L-H" Rise Time	$t_r$	$I_{IH} = 16\text{mA}$	—	0.3	1	$\mu\text{s}$
"H-L" Propagation Time	$t_{PHL}$	$I_{IH} = 16\text{mA}$	—	0.4	0.9	$\mu\text{s}$
"H-L" Fall Time	$t_f$	$I_{IH} = 16\text{mA}$	—	0.3	1	$\mu\text{s}$

**VLA507-01**  
Hybrid IC IGBT Gate Driver

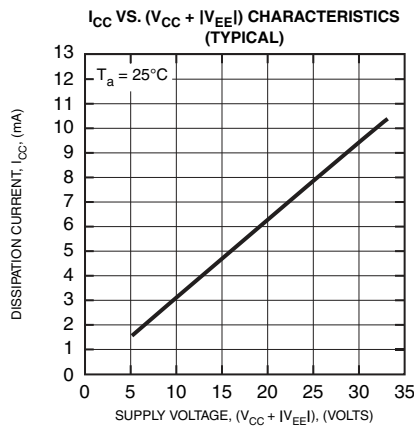
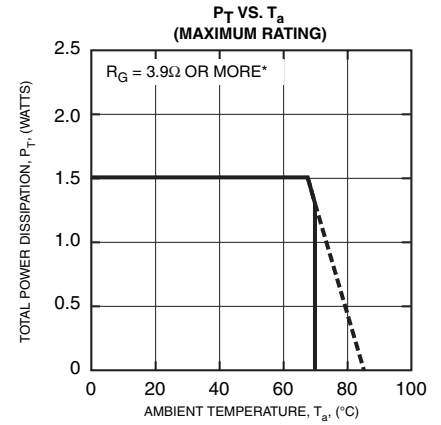
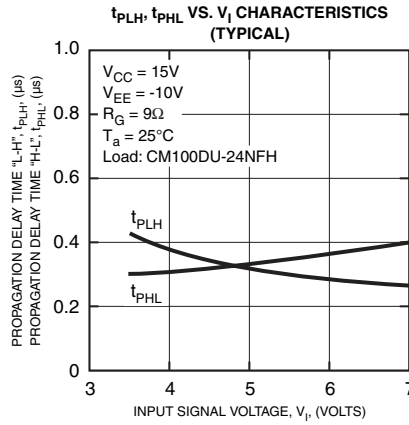
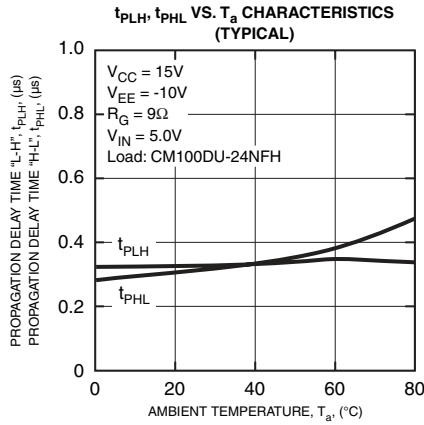

\* The following numerical expression must be satisfied  
 $PT > (V_{CC} + |V_{EE}|) * ((Q_1 + |Q_2|) * f + I_{CC})$   
 $Q_1$ : Gate Charge on plus bias  
 $Q_2$ : Gate Charge on minus bias  
 $f$ : Switching frequency  
 $I_{CC}$ : Constant dissipation current of driver  
 Refer to " $I_{CC}$  VS.  $(V_{CC} + |V_{EE}|)$  Characteristics"

**Application Circuit**

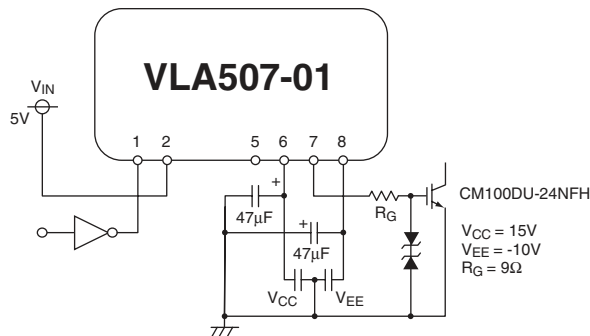

**Notes:**

- (1) Power supply decoupling capacitors should be connected as close as possible to the pins of the gate driver.
- (2) Power supply decoupling capacitors should be good quality, low ESR types.
- (3) Printed circuit layout should minimize wiring lengths and utilize shielding layers to suppress noise.

**Switching Time Definitions**

