



# Energy Ready Reference Guide

Generation • Distribution • Transmission

Raychem Cable Accessories, ALR Photocontrols, AMP Connectors

CONNECTORS & TERMINALS .....	1
IDENTIFICATION SOLUTIONS .....	91
LOW VOLTAGE SPLICES & TAPS .....	103
MEDIUM VOLTAGE CABLE ACCESSORIES .....	123
HIGH VOLTAGE CABLE ACCESSORIES & INSULATORS .....	189
CABLE REPAIR & REJACKETING .....	201
TUBING & MOLDED PARTS .....	207
TAPE & SEALANTS .....	215
PHOTOCONTROLS, TIMERS & ACCESSORIES .....	223
ASSET PROTECTION .....	237
ACCESSORIES & TOOLS .....	261
APPLICATIONS & TECHNICAL SPECIFICATIONS .....	275
INDEX .....	303

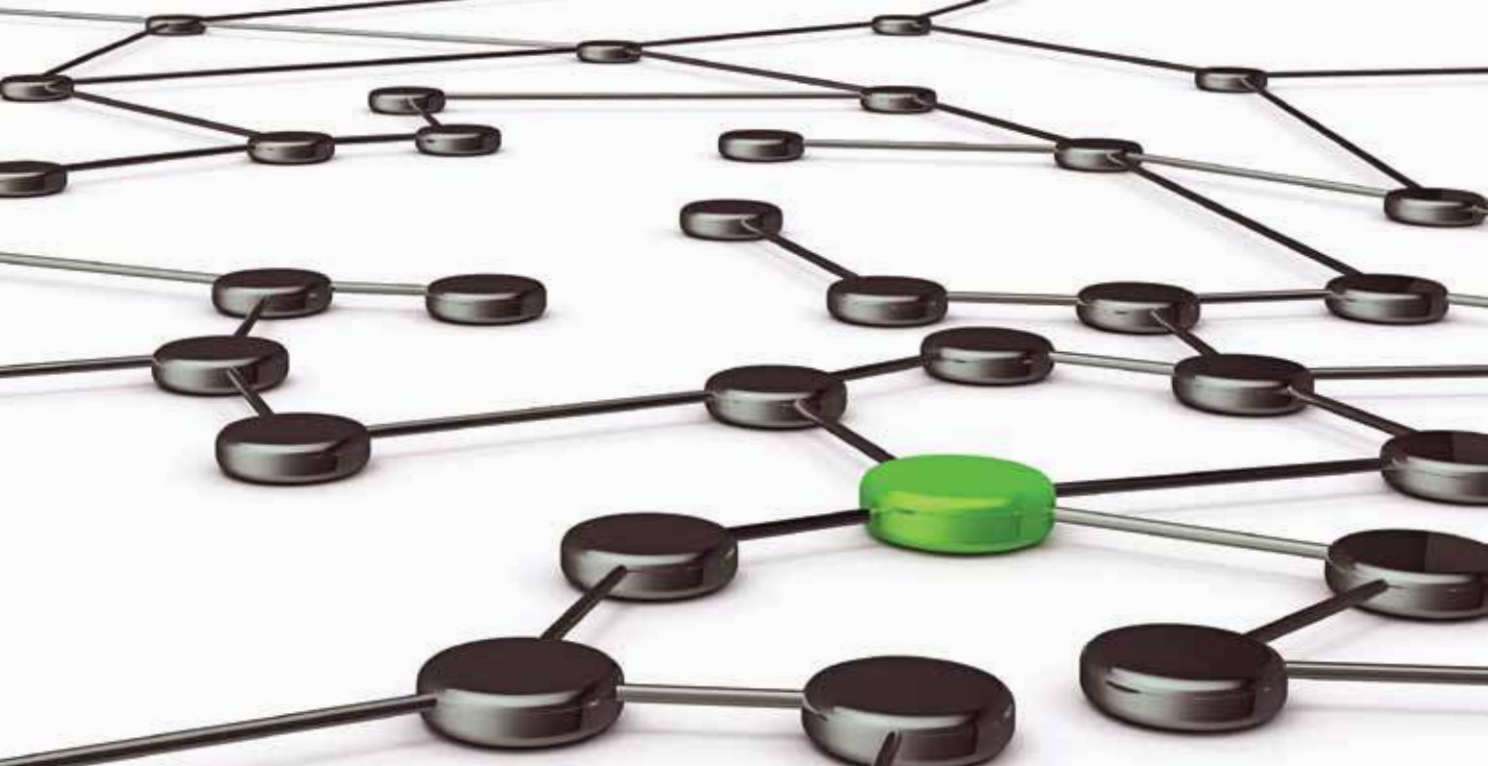

# CONNECTORS & TERMINALS

## ShearBolt Connectors

Aluminum ShearBolt Splice Connectors . . . . .	2
Copper ShearBolt Splice Connectors . . . . .	3
Aluminum ShearBolt Terminal Connectors . . . . .	4

## Compression Connectors

Copper Compression Terminals . . . . .	5
Copper Compression Splices . . . . .	7

## Insulation Piercing Connectors

Insulation Piercing Connectors . . . . .	8
--	---

## Wedge Pressure Connectors

Wedge Pressure Technology . . . . .	9
AMPACT Aluminum Tap System . . . . .	9
AMPACT EL . . . . .	13
AMPACT HTT . . . . .	13
Stirrups . . . . .	14
AMPACT Stud Disconnect System . . . . .	15
Identifier Plates . . . . .	15
AMPACT Deadend Clamp Assembly . . . . .	16
AMPACT In-Line Disconnect Switch . . . . .	17

## AMPACT Accessories

Terminal Lugs . . . . .	19
URD Tap Cover . . . . .	20
GelPact Cover . . . . .	20
Tap Cover . . . . .	20
AMPACT Tool . . . . .	21
AMPACT EZ Load . . . . .	22
Cartridges . . . . .	22
Inhibitor Compound & NEMA Hinge . . . . .	22
Cleaning Tool . . . . .	23
Take-off Clip . . . . .	23
Auxiliary Platform . . . . .	23
Accessories Bag . . . . .	23
Transverse Wedge Connectors . . . . .	23
Hot-Stick . . . . .	26

## MINIWEDGE Connectors

Service Entrance Connector System . . . . .	27
GHFC MW Closure . . . . .	27

## Copper Grounding

AMPACT Copper Wire Tap . . . . .	32
Copper Terminal Lug . . . . .	35
SHEAR-LOK Grounding Connector . . . . .	35
WRENCH-LOK Grounding Connector . . . . .	36
Universal Distribution Connector . . . . .	40

## Symmetrical Connector Selection Chart

Selection Chart . . . . .	44
---------------------------	----

## AMPACT Selection Guide

Aluminum Taps . . . . .	45
Copper Taps . . . . .	80
Stirrups . . . . .	97



C\_ASBC



C\_ASBC\_Wrench

## Aluminum ShearBolt Splice Connectors #2 AWG Compact to 1000 kcmil Stranded

TE Connectivity's Aluminum ShearBolt connectors are range-taking mechanical connectors. Just six connectors will accommodate a wide range of aluminum and copper conductors from #2 AWG compact stranded to 1000 kcmil standard stranded class B. The primary application of Aluminum ShearBolt connectors is for underground splices up to 35 kV.

ShearBolt connectors are ideally suited for aluminum to aluminum, aluminum to copper and copper to copper applications making them the universal connector solution. Please refer to tests listed below.

The only tool required to install the connector is a standard ratchet wrench with the appropriate sized hexagonal sockets. The connector design incorporates shear head bolts, which ensures that the correct torque is applied to each bolt and consequently the optimal contact force is generated to minimize connection resistance. A holding tool is recommended to avoid core bending of conductors and can be ordered from TE Connectivity (#188072-000).

TE's cordless impact wrench (#CA7469-000) can also be used to install the connector. This convenient and quick tool has been tested and qualified to install ShearBolt connectors.

The solid center stop (available on most sizes) inside the connector ensures proper conductor positioning and eliminates oil leakage when connecting oil impregnated conductors.

Two removable inserts in the connector body centralize smaller conductor sizes. For larger sizes, inserts are not required and are easily removed with a standard screwdriver.

ShearBolt connectors meet the electrical requirements (Class A) of ANSI C119.4 and exceed the mechanical requirements of a class 3 connector by a large margin of safety.

ShearBolt connectors are designed to be compatible with TE's Raychem brand cable accessories and insulation products.

### Selection Information: dimensions shown in inches (millimeters)

Catalog Number	Conductor Range	OD Range	Length	Connector O.D.	Stop
ASBS-2-3/0	2 AWG compact stranded to 3/0 AWG standard stranded	.268-.470 (6.8-11.9)	2.5 (65)	.95 (24)	Disc
ASBS-2-350	2 AWG compact stranded to 350 kcmil standard stranded	.268-.681 (6.8-17.3)	3.9 (100)	1.22 (31)	Solid
ASBS-3/0-500	3/0 AWG compact stranded to 500 kcmil standard stranded	.423-.813 (10.7-20.6)	4.9 (125)	1.3 (34)	Disc
ASBS-3/0-500-S	3/0 AWG compact stranded to 500 kcmil standard stranded	.423-.813 (10.7-20.6)	4.9 (125)	1.3 (34)	Solid
ASBS-500-750	500 kcmil compact stranded to 750 kcmil standard stranded	.736-.998 (18.7-25.3)	6.0 (152)	1.52 (39)	Solid
ASBS-350-750	350 kcmil compact stranded to 750 kcmil standard stranded	.616-.998 (15.6-25.3)	6.7 (170)	1.67 (42.5)	Solid
ASBS-600-1000	600 kcmil compact stranded to 1000 kcmil standard stranded	.813-1.152 (20.6-29.2)	8.0 (203)	1.75 (44.4)	Solid

### Application Information

Catalog Number	PII Number*	Socket Size	Test Reports	Conductor Combination
ASBS-2-3/0	408-8990	1/2	Note 1	Note 1
ASBS-2-350	408-8990	11/16	502-47292(I) 502-47300(I) 502-47340(I)	4/0 kcmil Cu to 350 kcmil AAC 350 kcmil AAC to 350 kcmil AAC 350 kcmil CU to 350 kcmil CU
ASBS-3/0-500	408-8990	3/4	502-47331(I) 502-47331(I)	500 kcmil AAC to 500 kcmil AAC 500 kcmil CU to 500 kcmil CU
ASBS-3/0-500-S	408-10429	3/4	502-47331(I) 502-47331(I)	500 kcmil AAC to 500 kcmil AAC 500 kcmil CU to 500 kcmil CU
ASBS-350-750	408-8990	7/8	502-47329(I)	750 kcmil AAC to 750 kcmil AAC
ASBS-500-750	408-8990	3/4	502-47288(I) 502-47294(I)	500 kcmil CU to 750 kcmil CU 750 kcmil AAC to 750 kcmil AAC
ASBS-600-1000	408-8990	7/8	502-47289(I) 502-47344(I) 502-47305(I)	750 kcmil CU to 1000 kcmil AAC 1000 kcmil CU to 1000 kcmil CU 1000 kcmil AAC to 1000 kcmil AAC

\*Installation Instructions Reference Number

Note: The part number was not tested as ANSI C119.4 allows a smaller size connector of the same design to be added without additional testing.



C\_CSBC



C\_CSBC\_Wrench

## Copper ShearBolt Splice Connectors #2 AWG Compact to 1000 kcmil Stranded

TE Connectivity's Copper ShearBolt connectors are range-taking, mechanical connectors that will accommodate a wide range of copper cables from #2 AWG compact stranded to 1000 kcmil compact stranded. The primary application is for underground splices up to 35 kV.

The tool required to install the connector is a standard ratchet wrench with hexagonal sockets. The connector design incorporates shear head bolts, which ensures that the correct torque is applied to each bolt and consequently to the end of each conductor. A holding tool is recommended to avoid core bending of conductors and can be ordered separately (#188072-000). TE's cordless impact wrench (#CA7469-000) can also be used to install the connector. This tool offers convenience and speed and has been tested and qualified to install ShearBolt connectors. It eliminates the need for a holding tool. Please refer to accessory and tool section for ordering information.

The connector is supplied with two copper inserts assembled into the connector body to center small conductor sizes. For larger sizes, inserts are not required and are easily removed with a standard screwdriver. Please see the installation table for details. An oxide-inhibiting joint compound is factory-applied in the barrel of the connector to provide low initial contact resistance, seal out air and moisture, prevent oxidation/corrosion, and maintain a reliable connection for the life of the installation.

The connectors have been electrically tested to the class A requirements of ANSI C119.4 and mechanically rated at a pull out force of 1670 lbs for the #2 AWG to 250 kcmil version; 2300 lbs for the 2/0 AWG to 500 kcmil version; 3000 lbs for the 300 kcmil to 750 kcmil version; and 3800 lbs for the 500 kcmil to 1000 kcmil version. Engineering Test Reports are available upon request

Copper ShearBolt connectors have an impermeable oil block for connecting paper-insulated cables.

### Selection Information: dimensions shown in inches (millimeters)

Catalog Number	Conductor Cable Range	Conductor OD Range	Length	Connector O.D.	Stop
CSBS-2-250	#2 AWG compact to 250 kcmil stranded	.268-.575 (6.81-14.61)	3.2 (81)	1.05 (26.7)	Solid
CSBS-2/0C-500C	2/0 compact to 500 kcmil compact	.376-.736 (9.5-18.7)	4 (101)	1.2 (30.5)	Solid
CSBS-2/0-500-CPR	2/0 compact to 500 kcmil compressed	.376-.79 (9.5-20)	4 (101)	1.3 (33)	Solid
CSBS-300C-750C	300 kcmil compact to 750 kcmil compact	.570-.945 (14.5-24.0)	5 (127)	1.45 (36.8)	Solid
CSBS-300-750	300 kcmil compact to 750 kcmil standard	.570-.99 (14.5-25.4)	5 (127)	1.5 (38.1)	Solid
CSBS-500-1000	500 kcmil compact to 1000 kcmil stranded	.736 to 1.152 (1.87-2.93)	7 (18)	1.75 (44.4)	Solid

### Installation

Copper ShearBolt connectors use four (six for the CSBS 500-1000) bronze alloy shear head bolts, two (or three) on each side of the center stop. A torque wrench is not required. The only tool required is a standard ratchet wrench with a hexagonal socket.

\* Refer to the following installation table.

Catalog Number	PII Number*	Socket Size	Test Reports	Application Guide
CSBS-2-250	408-10327	1/2 (13)	502-47407	Remove inserts for cable sizes equal to or greater than 4/0 AWG compressed
CSBS-2/0C-500C	408-8894	11/16 (17)	502-47265	Remove inserts for cable sizes equal to or greater than 300 kcmil compact.
CSBS-2/0-500-CPR	408-10327	11/16 (17)	502-47265	Remove inserts for cable sizes equal to or greater than 350 kcmil compressed.
CSBS-300C-750C	408-8863	3/4 (19)	502-47257 502-47260	Remove inserts for cable sizes equal to or greater than 500 kcmil compact.
CSBS-300-750	408-10327	3/4 (19)	502-47260	Remove inserts for cable sizes equal to or greater than 600 kcmil compressed.
CSBS-500-1000	408-10327	3/4 (19)	502-47386	Remove inserts for cable sizes equal to or greater than 750 kcmil stranded

\*Installation Instructions Reference Number

Please contact your TE Connectivity representative for conductor sizes or types not listed in this catalog.



C\_ASBT



C\_ASBT\_Wrench

## Aluminum ShearBolt Terminal Connectors #2 AWG Compact to 1000 kcmil Stranded

TE Connectivity's Aluminum ShearBolt Terminals (ASBT) are range-taking mechanical connectors that will accommodate a conductor range from #2 compact stranded to 1000 kcmil stranded, Class B. The primary application of the ASBT is for power cable terminations, both underground and above ground at voltages up to 35 kV. ASBT is ideally suited for making aluminum or copper cable connections to flat bar or equipment pads equipped with 2-hole NEMA spacing.

To extend the range of each connector, an aluminum insert is assembled into the connector body, which centers the smaller conductor sizes in the barrel of the connector. For larger sizes the insert is not required and is easily removed with a standard screwdriver. An oxide-inhibiting joint compound is factory applied in the connector barrel to maintain a reliable connection for the life of the installation.

The connector design incorporates shear head bolts, which ensures that the correct torque is applied to each bolt and consequently the optimal contact force is generated to minimize connection resistance. The primary tool required to install the connector is a standard ratchet wrench with the appropriate hexagonal sockets. The TE Connectivity cordless impact wrench (#CA7469-000) can also be used to install the connector.

The connectors have been electrically tested to the class A requirements of ANSI C119.4 and exceed the mechanical requirements of a class 3 connector by a large margin of safety. The existing Aluminum ShearBolt Splice (ASBS) connector Engineering Test Reports are applicable since the barrel end of the ASBT exactly replicates the design criteria of the ASBS.

### Selection Information: dimensions shown in inches (millimeters)

Catalog Number	Length	OD	Socket Size	Conductor Range	Conductor OD Range	Remove Insert for Conductor Size Greater Than
ASBT-2-350 (2-Bolt)	5.9 (1.49)	1.22 (31)	11/16 (17)	2 AWG Compact to 350 kcmil Stranded	.268-.681 (6.8-17.3)	4/0 AWG Stranded (.528 (13.4) Conductor Dia.)
ASBT-350-750 (3-Bolt)	7.4 (1.88)	1.67 (42.5)	7/8 (22)	350 kcmil Compact to 750 kcmil Stranded	.616-.998 (15.7-25.3)	600 kcmil Compact (.813 (20.6) Conductor Dia.)
ASBT-600-1000 (3-Bolt)	7.7 (1.96)	1.75 (44.4)	7/8 (22)	600 kcmil Compact to 1000 kcmil Stranded	.813-1.152 (20.6-29.2)	750 kcmil Stranded (.998 (25.3) Conductor Dia.)

### Engineering Test Information

Catalog Number	TE Part Number	RPN Part Number	Test Number	Conductor
ASBT-2-350	1099368-1	CM9694-000	N/A	See below conductors for ASBS-2-350 test reports
ASBT-350-750	1099369-1	CM9695-000	N/A	See below conductor for ASBS-350-750 test report.
ASBT-600-1000	1099585-1	CM9696-000	502-47363, Rev. O 502-47370	1000 kcmil AAC 1000 kcmil CU

Please contact your TE Connectivity representative for conductor sizes or types not listed in this datasheet.

### Engineering Test Information:

Catalog Number	Installation Instruction Number	Socket Size	Test Number	Conductor Combination
ASBS-2-350	408-8990	11/16"	502-47292(I) 502-47300(I) 502-47340(I)	4/0 kcmil Cu to 350 kcmil AAC 350 kcmil AAC to 350 kcmil AAC 350 kcmil Cu to 350 kcmil CU
ASBS-350-750	408-8990	7/8"	502-47329(I)	750 kcmil AAC to 750 kcmil AAC
ASBS-600-1000	408-8990	7/8"	502-47289(I) 502-47344(I) 502-47305(I)	750 kcmil Cu to 1000 kcmil AAC 1000 kcmil Cu to 1000 kcmil CU 1000 kcmil AAC to 1000 kcmil AAC



C\_CUCT

## Copper Compression Terminals

- Uses industry-standard tooling for simple installation
- Industry-standard color coding system simplifies die selection
- Chamfered connector end allows cable to be inserted easily
- One-piece, seamless construction from electrolytic tough pitch (ETP) copper for superior electrical performance and mechanical operation
- Closed barrel transition design for protection from moisture and contaminants
- Tin-plated for corrosion resistance and durability, and tempered for easy crimping

Copper compression terminals are ideally suited for secondary power distribution in buildings, power plants, electrical equipment, and industrial applications. Connectors can be used on applications up to 35 kV, and meet the requirements of UL486A and CSA C22.2 No. 65-95 when applied with approved die sets. (See Instruction Sheet #408-8869 for approved listing of die sets).



Copper compression terminals are available to accommodate a range of cable sizes from 6 AWG through 1,000 MCM and are designed for terminating concentric, compressed, and compact conductors. These terminals are offered in one-hole terminals from 6 AWG through 1,000 MCM with either a standard or long barrel. A two-hole NEMA terminal with a long barrel is also available for 4 AWG through 1,000 MCM.

Compression crimping forms the terminal barrel and conductor into a strong, almost homogeneous unit, producing excellent conductivity, low temperature rise, and outstanding resistance to oxidation and corrosion.

### Physical and Electrical Properties

Material:	ETP copper alloy C11000
Plating:	Electro tin plate
Heat treating:	Soft tempered
Voltage Rating:	For applications up to 35 kV consult shielded cable manufacturers stress relief instructions.

Agency approvals (when crimped with the approved die sets): Listed by Underwriters Laboratories, Inc. File No. E13288, Compression terminal connectors comply with the requirements of UL486A and CSA C.22.2 No. 65-93.

# Compression Connectors

One Hole, Short Barrel

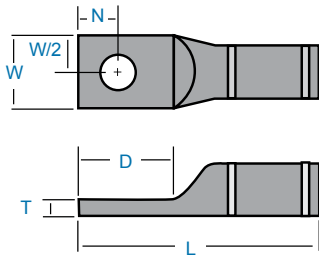

One Hole, Long Barrel

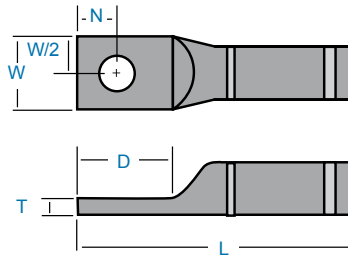

Two-Hole NEMA, Long Barrel

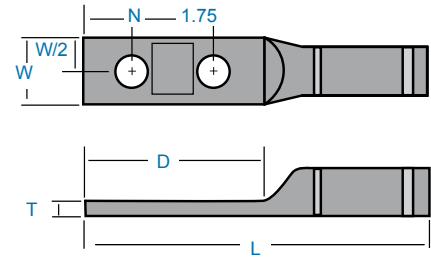

**Selection Information: dimensions shown in inches**

Catalog Number	Conductor	Stud Size	Dimensions					Color Code
			L	W	T	D	N	
<b>One Hole, Short Barrel</b>								
1099898-1	6 STR.	1/4	1.5	0.45	0.08	0.56	0.27	blue
1099898-2	4 STR.	1/4	1.5	0.50	0.09	0.56	0.27	gray
1099898-3	3 STR.	5/16	1.6	0.57	0.09	0.70	0.34	white
1099898-4	2 STR.	5/16	1.6	0.61	0.11	0.70	0.34	brown
1099898-5	1 STR.	1/4	1.6	0.68	0.10	0.56	0.27	green
1099898-6	1/0 STR.	5/16	1.7	0.74	0.12	0.70	0.34	pink
1099898-7	1/0 STR.	1/2	2.1	0.88	0.09	1.08	0.53	pink
1099898-8	2/0 STR.	3/8	1.9	0.83	0.12	0.83	0.41	black
1099898-9	3/0 STR.	1/2	2.2	0.91	0.13	1.08	0.53	orange
1-1099898-0	4/0 STR.	1/2	2.2	1.02	0.14	1.08	0.53	purple
1-1099898-1	250 MCM	1/2	2.4	1.11	0.16	1.08	0.53	yellow
1-1099898-2	350 MCM	1/2	2.5	1.27	0.18	1.08	0.53	red
1-1099898-3	500 MCM	1/2	3.2	1.54	0.23	1.30	0.65	brown
1-1099898-4	750 MCM	5/8	4.0	1.88	0.27	1.94	0.88	black
1-1099898-5	1000 MCM	5/8	4.9	2.16	0.32	2.12	0.94	white
<b>One Hole, Long Barrel</b>								
1099899-1	6 STR.	1/4	1.9	0.45	0.08	0.56	0.34	blue
1099899-2	4 STR.	1/4	1.9	0.50	0.09	0.56	0.38	gray
1099899-3	3 STR.	5/16	2.3	0.57	0.09	0.70	0.38	white
1099899-4	2 STR.	5/16	2.3	0.60	0.11	0.75	0.38	brown
1099899-5	1 STR.	5/16	2.4	0.68	0.10	0.75	0.27	green
1099899-6	1/0 STR.	5/16	2.4	0.74	0.12	0.75	0.27	pink
1099899-7	1/0 STR.	1/2	2.7	0.75	0.11	1.08	0.53	pink
1099899-8	2/0 STR.	3/8	2.7	0.82	0.12	0.88	0.44	black
1099899-9	3/0 STR.	1/2	2.9	0.91	0.13	1.08	0.53	orange
1-1099899-0	4/0 STR.	1/2	3.0	1.00	0.14	1.08	0.53	purple
1-1099899-1	250 MCM	1/2	3.2	1.09	0.16	1.12	0.56	yellow
1-1099899-2	300 MCM	1/2	3.6	1.19	0.16	1.12	0.56	white
1-1099899-3	350 MCM	1/2	3.7	1.28	0.18	1.12	0.56	red
1-1099899-4	400 MCM	5/8	4.2	1.38	0.19	1.50	0.75	blue
1-1099899-5	500 MCM	5/8	4.4	1.52	0.23	1.50	0.75	brown
1-1099899-6	500 MCM	1/2	4.2	1.54	0.23	1.30	0.65	brown
1-1099899-7	600 MCM	5/8	5.2	1.69	0.27	1.75	0.88	green
1-1099899-8	750 MCM	5/8	5.4	1.89	0.27	1.94	0.88	black
1-1099899-9	1000 MCM	5/8	6.0	2.17	0.32	2.12	0.94	white
<b>Two-Hole NEMA, Long Barrel</b>								
1099939-1	4 STR.	1/2	4.4	0.83	0.11	3.00	0.62	gray
1099939-2	3 STR.	1/2	4.4	0.83	0.11	3.00	0.62	white
1099939-3	2 STR.	1/2	4.5	0.82	0.11	3.00	0.62	brown
1099939-4	1 STR.	1/2	4.7	0.80	0.09	3.00	0.62	green
1099939-5	1/0 STR.	1/2	4.7	0.75	0.12	3.00	0.62	pink
1099939-6	2/0 STR.	1/2	4.8	0.82	0.12	3.00	0.62	black
1099939-7	3/0 STR.	1/2	4.8	0.90	0.12	3.00	0.62	orange
1099939-8	4/0 STR.	1/2	5.0	1.00	0.14	3.00	0.62	purple
1099939-9	250 MCM	1/2	5.0	1.09	0.16	3.00	0.62	yellow
1-1099939-0	300 MCM	1/2	5.4	1.18	0.16	3.00	0.62	white
1-1099939-1	350 MCM	1/2	5.4	1.27	0.18	3.00	0.62	red
1-1099939-2	500 MCM	1/2	5.7	1.53	0.23	3.00	0.62	brown
1-1099939-3	600 MCM	1/2	6.2	1.71	0.27	3.00	0.62	green
1-1099939-4	750 MCM	1/2	6.5	1.89	0.27	3.00	0.62	black
1-1099939-5	1000 MCM	1/2	6.8	2.16	0.33	3.00	0.62	white

**Additional Information:**

PII Number 408-8869





C\_CUCS

## Copper Compression Splices

- Uses industry-standard tooling for simple installation
- Industry-standard color coding system simplifies die selection
- Chamfered connector end allows cable to be inserted easily
- One-piece, seamless construction from electrolytic tough pitch (ETP) copper for superior electrical performance and mechanical operation
- Tin-plated for corrosion resistance and durability, and tempered for easy crimping

Copper compression splices are ideally suited for secondary power distribution in buildings, power plants, electrical equipment, and industrial applications. Connectors can be used on applications up to 35 kV, and meet the requirements of UL486A and CSA C22.2 No. 65-95 when applied with approved die sets. (See Instruction Sheet #408-8969 for approved listing of die sets).

Copper compression splices are available to accommodate a range of cable sizes from 6 AWG through 1,000 MCM and are designed for splicing concentric, compressed and compact conductors. These splices are offered from 6 AWG through 1,000 MCM with either a standard or long barrel.

Compression crimping forms the splice and conductor into a strong, almost homogeneous unit, producing excellent conductivity, low temperature rise, and outstanding resistance to oxidation and corrosion.

### Physical and Electrical Properties

Material: ETP copper alloy C11000  
 Plating: Electro tin plate  
 Heat treating: Soft tempered  
 Voltage rating: For applications up to 35 kV  
 Consult shielded cable manufacturers' stress relief instructions.

Agency approvals (when crimped with the approved die sets): Listed by Underwriters Laboratories, Inc. File No. E13288, Compression splice connectors comply with the requirements of UL486A and CSA C.22.2 No. 65-93.

### Selection Information: dimensions shown in inches (millimeters)

Catalog Number	Conductor	Length		Outside Diameter	Color Code
		L	L/2	D	

#### Standard Barrel Splice

1443402-1	#6 STR	1.75	0.83	0.292	Blue
1443402-2	#4 STR	2.00	0.96	0.340	Gray
1443402-3	#3 STR	2.09	1.00	0.377	White
1443402-4	#2 STR	2.09	1.00	0.418	Brown
1443402-5	#1 STR	2.09	1.00	0.462	Green
1443402-6	1/0 STR	2.09	1.00	0.515	Pink
1443402-7	2/0 STR	2.18	1.05	0.583	Black
1443402-8	3/0 STR	2.32	1.11	0.618	Orange
1443402-9	4/0 STR	2.32	1.12	0.691	Purple
1-1443402-0	250 MCM	2.50	1.19	0.753	Yellow
1-1443402-1	300 MCM	2.50	1.19	0.815	White
1-1443402-2	350 MCM	2.62	1.25	0.844	Red
1-1443402-3	400 MCM	2.75	1.31	0.953	Blue
1-1443402-4	500 MCM	3.15	1.50	1.064	Brown
1-1443402-5	600 MCM	3.25	1.55	1.185	Green
1-1443402-6	750 MCM	3.75	1.80	1.302	Black
1-1443402-7	1000 MCM	4.26	2.06	1.504	White

#### Long Barrel Splice

1443403-1	#6 STR	2.41	1.16	0.292	Blue
1443403-2	#4 STR	2.41	1.16	0.340	Gray
1443403-3	#3 STR	2.53	1.22	0.377	White
1443403-4	#2 STR	2.65	1.28	0.418	Brown
1443403-5	#1 STR	2.91	1.41	0.462	Green
1443403-6	1/0 STR	2.91	1.41	0.515	Pink
1443403-7	2/0 STR	3.15	1.53	0.583	Black
1443403-8	3/0 STR	3.15	1.53	0.618	Orange
1443403-9	4/0 STR	3.39	1.63	0.691	Purple
1-1443403-0	250 MCM	3.39	1.63	0.753	Yellow
1-1443403-1	300 MCM	4.13	2.00	0.815	White
1-1443403-2	350 MCM	4.13	2.00	0.844	Red
1-1443403-3	400 MCM	4.38	2.13	0.953	Blue
1-1443403-4	500 MCM	4.62	2.23	1.064	Brown
1-1443403-5	600 MCM	5.50	2.67	1.185	Green
1-1443403-6	750 MCM	5.88	2.86	1.302	Black
1-1443403-7	1000 MCM	6.12	2.96	1.504	White

### Additional Information:

PII Number 408-8969

Standard Barrel Splice

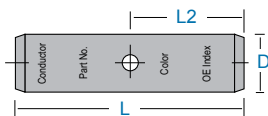

Long Barrel Splice

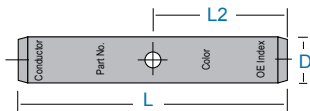



C\_IPC

## Insulation Piercing Connectors

Insulation Piercing Connectors (IPCs) provide electrical connection for aluminum and copper stranded conductors without stripping and removing insulation from the conductors. During installation the IPC establishes electrical contact, protects, and seals the contact interface, and electrically insulates the connection, eliminating the need for weather-proofing and re-insulating.

### Features

- Wide conductor range, bare and insulated cables
- Suitable for aluminum and copper conductors
- Tin-plated copper alloy contacts pierce insulation sheath
- Single bolt application with ring washers provide residual contact force
- Torque-control nut for precise pressure on conductor and insulation
- Operating temperature from -40°C to +55°C
- Quick, reliable, and safe connections on energized conductors (not under load)
- Contact TE Connectivity for sizes not listed
- Meets ANSI C119.5 requirements
- Test reports available upon request.

### Selection Information: dimensions shown in inches (millimeters)

Catalog Number	Main Al/Cu		Tap Al/Cu		Dimensions		Std. Pack
	Min. AWG	Max. AWG	Min. AWG	Max. AWG	Shear Head	Weight (g)	
SIML-1727742-1 (P3X-4/0)	4 (25)	4/0 Al-2/0 Cu (95-70)	4 (25)	4/0 Al-2/0 Cu (95-70)	9/16 Install 3/4 Remove	202	20
SIML-1-708052-1 (KZEP-4/0)	6 (16)	4/0 (95)	14 (1.5)	10 (6)	10 mm Install 13 mm Remove	54	50

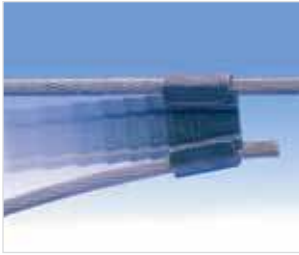

C\_wedge

## Wedge Pressure Technology

The key to higher efficiency and more reliable power connections

TE Connectivity's AMP utility connectors are designed around an engineering principle that TE calls "Wedge Pressure Technology". Field proven for more than 40 years, Wedge Pressure Technology has formed the basis for a complete family of connectors that outperforms other connectors types, resulting in "lowest life cycle cost" for our customers.

Developed to overcome the physical and electrical limitations of traditional compression or bolted connectors. Its design addresses four key areas affecting connectors performance by:

- Maximizing contact between the connector and conductor surfaces
- Overcoming the problems associated with oxidation of metallic surfaces
- Maintaining a constant force within the connection for the life of the connector, while compensating for thermal expansion or "creep"
- Providing a simple, fool proof method for connector installation



C\_ampactAtap

## AMPACT Aluminum Tap System

The proven AMPACT tap "C-spring" and wedge design provides a stored energy system that prevents connector degradation and achieves significantly lower resistance than any competitive product over the "in service" life of the connector. As thermal cycling causes the conductors to expand and contract, the AMPACT tap spring member flexes and maintains constant contact pressure.

- Installing taps takes a fraction of the time needed for conventional crimp-type connectors
- A locking tab prevents wedge from loosening once it has been driven into position. Every connection may be visually inspected by checking wedge movement and locking tab.
- Taps may be used to connect multiple conductor combinations
- No damage to the conductors when installing or removing tap
- Lightweight, power-actuated tools require minimum operator effort
- "C" and wedge are factory coated with an inhibitor containing abrasive particles to help clean the contact surfaces during installation
- Individual tap packages are imprinted with applicable conductor combinations. Packages and labels are color coded to easily match taps with proper tool and cartridge combination

The "C" and wedge are made of aluminum alloys. They are used to connect solid and stranded aluminum, aluminum alloy and stranded aluminum composite conductors including AAC, AAAC, ACSR, ACAR, AW, ACSR/AW, and ACSS. They may also be used in non-corrosive environments to connect copper conductors.



Listed File No. E13288

RUS: ANSI C119.4  
Class AA - Electrical  
Class 1 - Mechanical

Conductor Standard Sizes	Size Tap Conductor Applicable
1192.5 kcmil	1192.5 thru 6
1033.5	1033.5 thru 6
795	795 thru 6
556.5	556.5 thru 6
477	477 thru 6
397.5	397.5 thru 6
350	350 thru 6
336.4	336.4 thru 6
266.8	266.8 thru 6
4/0 AWG	4/0 thru 6
3/0	3/0 thru 6
2/0	2/0 thru 6
1/0	1/0 thru 14
2	2 thru 14
4	4 thru 14
6	6 thru 14
8	8 thru 14

AMPACT Aluminum Tap System Selection Guide

Catalog Number	Wire Combinations
<b>Type II Street Light Taps (White Cartridge P/N 69338-5 separately)</b>	
83653-1	1/0-10-12-14
83653-2	2-10-12-14
83653-5	4-10-12-14
83653-3	6-10-12-14
83653-4	8-10-12-14
<b>Type II Taps (White Cartridge P/N 69338-5 separately)</b>	
602283	1/0-2
602283-1	2-2; 1/0-4
602283-2	2-4; 1/0-6
602283-3	4-4; 2-6
602283-4	6-6; 4-6
602283-5	8-8
602283-6	1/0-8
602283-7	2-8
602283-8	6-8; 4-8
<b>Medium Taps (Blue Cartridge P/N 69338-1 separately)</b>	
600403	1/0-1/0; 2/0-2; 1/0-2
600411	2/0-2/0; 3/0-1/0; 4/0-2
600446	3/0-6; 2/0-6
600447	2/0-4; 3/0-4
600448	2/0-1/0; 3/0-2
600455	4/0-4
600456	4/0-4
600458	3/0-2/0; 4/0-1/0
600459	3/0-3/0; 4/0-2/0
600465	4/0-3/0
600466	4/0-4/0
<b>266.8 kcmil Taps (Blue Cartridge P/N 69338-1 separately)</b>	
602046-1	266.86
602046-2	266.8-4
602046-3	266.8-2
602046-4	266.8-1/0
602046-5	266.8-2/0
602046-6	266.8-3/0
602046-7	266.8-4/0
602046-9	266.8-266.8
<b>350 kcmil Taps (Blue Cartridge P/N 69338-1 separately)</b>	
602380	350-6
602380-1	350-4
602380-2	350-2
602380-3	350-1/0
602380-4	350-2/0
602380-5	350-3/0
602380-6	350-4/0
602380-7	350-350
<b>336.4-477-556.5 kcmil Taps (Yellow Cartridge P/N 69338-4 separately)</b>	
602014	336.4-6
602013	336.4-4
602000	336.4-2
602001	336.4-1/0
602002	336.4-2/0
602003	336.4-3/0
602004	336.4-4/0
602006	336.4-266.8
602007	336.4-336.4
602031-8	477.0-2, 3
602031-9	477.0-4, 5
1-602031-0	477.0-6
1-602031-2	556.5-477.0; 556.5
1-602031-3	477.0-477.0; 556.5-336.4
1-602031-4	477.0-336.4; 556.5-266.8
1-602031-5	477.0-266.8; 556.5-3/0; 4/0
1-602031-6	477.0-4/0; 556.5-2/0
1-602031-7	477.0-3/0; 556.5-1/0
1-602031-8	477.0-2/0; 556.5-1
1-602031-9	477.0-1/0; 556.5-2
2-602031-0	556.5-2; 3
2-602031-1	556.5-4; 5
2-602031-2	556.5-6

Tap Catalog Number	Wire Combinations
<b>795 kcmil Taps (Yellow Cartridge P/N 69338-4 separately)</b>	
602121	795-795
602121-1	795-715
602121-2	795-636
602121-3	795-556.5
602121-4	795-477
602121-5	795-397.5
602121-6	795-336.4
602121-7	795-266.8
602121-8	795-4/0
602121-9	795-3/0
1-602121-0	795-2/0
1-602121-1	795-1/0
1-602121-2	795-2
1-602121-3	795-4
1-602121-4	795-6
<b>1033.5 kcmil Taps (Yellow Cartridge P/N 69338-4 separately)</b>	
602180	1033.5-1033.5
602180-1	1033.5-954.0
602180-2	1033.5-795.0
602180-3	1033.5-715.5
602180-4	1033.5-636.0
602180-5	1033.5-556.5
602180-6	1033.5-477.0
602180-7	1033.5-397.5
602180-8	1033.5-336.4
602180-9	1033.5-266.8
1-602180-0	1033.5-4/0
1-602180-1	1033.5-3/0
1-602180-2	1033.5-2/0
1-602180-3	1033.5-1/0
1-602180-4	1033.5-2
1-602180-5	1033.5-4
1-602180-6	1033.5-6
<b>1192.5 kcmil Taps (Yellow Cartridge P/N 69338-4 separately)</b>	
602300	1192.5-1192.5
602300-1	1192.5-1033.5
602300-2	1192.5-954.0
602300-3	1192.5-795.0
602300-4	1192.5-715.5
602300-5	1192.5-636.0
602300-6	1192.5-556.5
602300-7	1192.5-477.0
602300-8	1192.5-397.5
602300-9	1192.5-336.4
1-602300-0	1192.5-266.8
1-602300-1	1192.5-4/0
1-602300-2	1192.5-3/0
1-602300-3	1192.5-2/0
1-602300-4	1192.5-1/0
1-602300-5	1192.5-2
1-602300-6	1192.5-4
1-602300-7	1192.5-6

Note: For specific wire sizes refer to the AMPACT Tap Selection Guide.

**AMPACT Aluminum Tap System Diameter Limits Selection Guide**  
(Dimensions shown in inches (millimeters))

Catalog Number	Sum of Diameters		(Large Groove ) Through Wire Diameter		(Small Groove) Tap Wire Diameter	
	Max.	Min.	Max.	Min.	Max.	Min.
<b>Type II Taps (White Coded)</b>						
602283	.724 (18.39)	.583 (14.81)	.398 (10.11)	.257 (6.53)	.398 (10.11)	.257 (6.53)
602283-1	.656 (16.66)	.515 (13.08)	.398 (10.11)	.257 (6.53)	.330 (8.38)	.204 (5.18)
602283-2	.602 (15.29)	.464 (11.79)	.398 (10.11)	.257 (6.53)	.258 (6.55)	.162 (4.11)
602283-3	.530 (13.46)	.410 (10.41)	.330 (8.38)	.204 (5.18)	.258 (6.55)	.162 (4.11)
602283-4	.456 (11.58)	.331 (8.41)	.258 (6.55)	.162 (4.11)	.230 (5.84)	.162 (4.11)
602283-5	.324 (8.23)	.256 (6.50)	.162 (4.11)	.128 (3.25)	.162 (4.11)	.128 (3.25)
602283-6	.560 (14.22)	.452 (11.48)	.398 (10.11)	.257 (6.53)	.162 (4.11)	.128 (3.25)
602283-7	.488 (12.40)	.387 (9.83)	.398 (10.11)	.257 (6.53)	.162 (4.11)	.128 (3.25)
602283-8	.416 (10.57)	.297 (7.54)	.258 (6.55)	.162 (4.11)	.162 (4.11)	.128 (3.25)
<b>Medium Wire Range Taps (Blue Coded)</b>						
600403	.796 (20.22)	.621 (15.77)	.500 (12.70)	.324 (8.23)	.464 (11.79)	.257 (6.53)
600411	.901 (22.89)	.736 (18.69)	.572 (14.53)	.364 (9.25)	.464 (11.79)	.257 (6.53)
600446	.707 (17.96)	.526 (13.36)	.572 (14.53)	.364 (9.25)	.204 (5.18)	.162 (4.11)
600447	.761 (19.33)	.570 (14.48)	.572 (14.53)	.364 (9.25)	.258 (6.55)	.204 (5.18)
600448	.846 (21.49)	.690 (17.53)	.572 (14.53)	.364 (9.25)	.398 (10.11)	.257 (6.53)
600455	.769 (19.53)	.622 (15.80)	.572 (14.53)	.364 (9.25)	.204 (5.18)	.162 (4.11)
600456	.823 (20.90)	.664 (16.87)	.572 (14.53)	.364 (9.25)	.258 (6.55)	.204 (5.18)
600458	.963 (24.46)	.804 (20.42)	.572 (14.53)	.364 (9.25)	.464 (11.79)	.257 (6.53)
600459	1.013 (25.73)	.858 (21.79)	.572 (14.53)	.364 (9.25)	.572 (14.53)	.364 (9.25)
600465	1.068 (27.13)	.938 (23.83)	.572 (14.53)	.364 (9.25)	.572 (14.53)	.364 (9.25)
600466	1.130 (28.70)	.956 (24.28)	.572 (14.53)	.364 (9.25)	.572 (14.53)	.364 (9.25)
<b>226.8 kcmil Range Taps (Blue Coded)</b>						
602046-1	.846 (21.49)	.699 (17.75)	.650 (16.51)	.525 (13.34)	.204 (5.18)	.162 (4.11)
602046-2	.900 (22.86)	.755 (19.18)	.650 (16.51)	.525 (13.34)	.258 (6.55)	.204 (5.18)
602046-3	.972 (24.69)	.818 (20.78)	.650 (16.51)	.525 (13.34)	.330 (8.38)	.257 (6.53)
602046-4	1.052 (26.72)	.897 (22.78)	.650 (16.51)	.525 (13.34)	.500 (12.70)	.324 (8.23)
602046-5	1.104 (28.04)	.963 (24.46)	.650 (16.51)	.525 (13.34)	.562 (14.27)	.364 (9.25)
602046-6	1.159 (29.44)	1.015 (25.78)	.650 (16.51)	.525 (13.34)	.562 (14.27)	.409 (10.39)
602046-7	1.217 (30.91)	1.080 (27.43)	.650 (16.51)	.525 (13.34)	.575 (14.61)	.460 (11.68)
602046-9	1.284 (32.61)	1.149 (29.18)	.650 (16.51)	.525 (13.34)	.650 (16.51)	.525 (13.34)
<b>350 kcmil Range Taps (Blue Coded)</b>						
602380	.885 (22.48)	.738 (18.75)	.684 (17.37)	.600 (15.24)	.204 (5.18)	.162 (4.11)
602380-1	.939 (23.85)	.794 (20.17)	.684 (17.37)	.600 (15.24)	.258 (6.55)	.204 (5.18)
602380-2	1.011 (25.68)	.857 (21.77)	.684 (17.37)	.600 (15.24)	.333 (8.46)	.257 (6.53)
602380-3	1.091 (27.71)	.936 (23.77)	.684 (17.37)	.600 (15.24)	.500 (12.70)	.324 (8.23)
602380-4	1.143 (29.03)	1.002 (25.45)	.684 (17.37)	.600 (15.24)	.562 (14.27)	.364 (9.25)
602380-5	1.198 (30.43)	1.054 (26.77)	.684 (17.37)	.600 (15.24)	.562 (14.27)	.409 (10.39)
602380-6	1.284 (32.61)	1.119 (28.42)	.684 (17.37)	.600 (15.24)	.600 (15.24)	.460 (11.68)
602380-7	1.368 (34.75)	1.188 (30.18)	.684 (17.37)	.600 (15.24)	.684 (17.37)	.600 (15.24)
<b>336.4 kcmil Range Taps (Yellow Coded)</b>						
602000	1.069 (27.15)	.860 (21.84)	.750 (19.05)	.524 (13.31)	.355 (9.02)	.257 (6.53)
602001	1.141 (28.98)	.927 (23.55)	.750 (19.05)	.524 (13.31)	.557 (14.15)	.324 (8.23)
602002	1.190 (30.23)	.967 (24.56)	.750 (19.05)	.524 (13.31)	.619 (15.72)	.364 (9.25)
602003	1.245 (31.62)	1.012 (25.70)	.750 (19.05)	.524 (13.31)	.619 (15.72)	.409 (10.39)
602004	1.306 (33.17)	1.063 (27.00)	.750 (19.05)	.524 (13.31)	.630 (16.00)	.460 (11.68)
602006	1.370 (34.88)	1.140 (28.96)	.750 (19.05)	.524 (13.31)	.750 (19.05)	.524 (13.31)
602007	1.456 (36.98)	1.206 (30.63)	.750 (19.05)	.524 (13.31)	.750 (19.05)	.524 (13.31)
602013	.999 (25.37)	.807 (20.50)	.750 (19.05)	.524 (13.31)	.258 (6.55)	.204 (5.18)
602014	.932 (23.67)	.765 (19.43)	.750 (19.05)	.524 (13.31)	.204 (5.18)	.162 (4.11)
<b>477.0 kcmil Range Taps (Yellow Coded)</b>						
602031-8	1.185 (30.10)	.995 (25.27)	.893 (22.68)	.666 (16.92)	.326 (8.28)	.257 (6.53)
602031-9	1.118 (28.40)	.942 (23.93)	.893 (22.68)	.666 (16.92)	.258 (6.55)	.204 (5.18)
1-602031-0	1.056 (26.82)	.900 (22.86)	.893 (22.68)	.666 (16.92)	.199 (5.05)	.162 (4.11)

AMPACT Aluminum Tap System Diameter Limits Selection Guide *continues*

Catalog Number	Sum of Diameters		(Large Groove) Through Wire Diameter		(Small Groove) Tap Wire Diameter	
	Max.	Min.	Max.	Min.	Max.	Min.
<b>477.0/556.5 kcmil Range Taps (Yellow Coded)</b>						
1-602031-2	1.854 (47.09)	1.692 (42.98)	.950 (24.13)	.722 (18.34)	.950 (24.13)	.722 (18.34)
1-602031-3	1.741 (44.22)	1.524 (38.71)	.940 (23.88)	.666 (16.92)	.940 (23.88)	.666 (16.92)
1-602031-4	1.587 (40.31)	1.366 (34.70)	.940 (23.88)	.666 (16.92)	.750 (19.05)	.573 (14.55)
1-602031-5	1.500 (38.10)	1.297 (32.94)	.940 (23.88)	.666 (16.92)	.750 (19.05)	.481 (12.22)
1-602031-6	1.421 (36.09)	1.216 (30.89)	.940 (23.88)	.666 (16.92)	.650 (16.51)	.436 (11.07)
1-602031-7	1.360 (34.54)	1.147 (29.13)	.940 (23.88)	.666 (16.92)	.562 (14.27)	.382 (9.70)
1-602031-8	1.305 (33.15)	1.102 (27.99)	.940 (23.88)	.666 (16.92)	.562 (14.27)	.346 (8.79)
1-602031-9	1.270 (32.26)	1.062 (26.97)	.940 (23.88)	.666 (16.92)	.450 (11.43)	.324 (8.23)
2-602031-0	1.247 (31.67)	1.115 (28.32)	.940 (23.88)	.666 (16.92)	.326 (8.28)	.257 (6.53)
2-602031-1	1.181 (30.00)	1.062 (26.97)	.940 (23.88)	.666 (16.92)	.258 (6.55)	.204 (5.18)
2-602031-2	1.126 (28.60)	1.020 (25.91)	.940 (23.88)	.666 (16.92)	.199 (5.05)	.162 (4.11)
<b>795.0 kcmil Range Taps (Yellow Coded)</b>						
602121	2.216 (56.29)	2.072 (52.63)	1.156 (29.36)	.858 (21.79)	1.158 (29.41)	.858 (21.79)
602121-1	2.159 (54.84)	2.002 (50.85)	1.156 (29.36)	.858 (21.79)	1.156 (29.36)	.858 (21.79)
602121-2	2.098 (53.29)	1.946 (49.43)	1.156 (29.36)	.858 (21.79)	1.156 (29.36)	.858 (21.79)
602121-3	2.035 (51.69)	1.891 (48.03)	1.156 (29.36)	.858 (21.79)	1.156 (29.36)	.858 (21.79)
602121-4	1.966 (49.94)	1.822 (46.28)	1.156 (29.36)	.858 (21.79)	.900 (22.86)	.700 (17.78)
602121-5	1.891 (48.03)	1.747 (44.37)	1.156 (29.36)	.858 (21.79)	.900 (22.86)	.700 (17.78)
602121-6	1.829 (46.46)	1.685 (42.80)	1.156 (29.36)	.858 (21.79)	.750 (19.05)	.525 (13.34)
602121-7	1.750 (44.45)	1.606 (40.79)	1.156 (29.36)	.858 (21.79)	.722 (18.34)	.525 (13.34)
602121-8	1.670 (42.42)	1.526 (38.76)	1.156 (29.36)	.858 (21.79)	.722 (18.34)	.364 (9.25)
602121-9	1.610 (40.89)	1.466 (37.24)	1.156 (29.36)	.858 (21.79)	.608 (15.44)	.364 (9.25)
1-602121-0	1.555 (39.50)	1.411 (35.84)	1.156 (29.36)	.858 (21.79)	.608 (15.44)	.364 (9.25)
1-602121-1	1.506 (38.25)	1.362 (34.59)	1.156 (29.36)	.858 (21.79)	.436 (11.07)	.324 (8.23)
1-602121-2	1.434 (36.42)	1.290 (32.77)	1.156 (29.36)	.858 (21.79)	.398 (10.11)	.257 (6.53)
1-602121-3	1.365 (34.67)	1.221 (31.01)	1.156 (29.36)	.858 (21.79)	.312 (7.92)	.204 (5.18)
1-602121-4	1.306 (33.17)	1.162 (29.51)	1.156 (29.36)	.858 (21.79)	.250 (6.35)	.162 (4.11)
<b>1033.5 kcmil Range Taps (Yellow Coded)</b>						
602180	2.496 (63.40)	2.332 (59.23)	1.250 (31.75)	.856 (21.74)	1.250 (31.75)	.856 (21.74)
602180-1	2.411 (61.24)	2.251 (57.18)	1.250 (31.75)	.856 (21.74)	1.250 (31.75)	.856 (21.74)
602180-2	2.354 (59.79)	2.194 (55.73)	1.250 (31.75)	.856 (21.74)	1.250 (31.75)	.856 (21.74)
602180-3	2.297 (58.34)	2.137 (54.28)	1.250 (31.75)	.856 (21.74)	1.250 (31.75)	.856 (21.74)
602180-4	2.236 (56.79)	2.076 (52.73)	1.250 (31.75)	.856 (21.74)	1.250 (31.75)	.856 (21.74)
602180-5	2.173 (55.19)	2.013 (51.13)	1.250 (31.75)	.856 (21.74)	1.250 (31.75)	.856 (21.74)
602180-6	2.104 (53.44)	1.944 (49.38)	1.250 (31.75)	.856 (21.74)	.900 (22.86)	.700 (17.78)
602180-7	2.029 (51.54)	1.869 (47.47)	1.250 (31.75)	.856 (21.74)	.900 (22.86)	.700 (17.78)
602180-8	1.967 (49.96)	1.807 (45.90)	1.250 (31.75)	.856 (21.74)	.750 (19.05)	.525 (13.34)
602180-9	1.888 (47.96)	1.728 (43.89)	1.250 (31.75)	.856 (21.74)	.722 (18.34)	.525 (13.34)
1-602180-0	1.808 (45.92)	1.648 (41.86)	1.250 (31.75)	.856 (21.74)	.608 (15.44)	.364 (9.25)
1-602180-1	1.748 (44.40)	1.588 (40.34)	1.250 (31.75)	.856 (21.74)	.608 (15.44)	.364 (9.25)
1-602180-2	1.693 (43.00)	1.533 (38.94)	1.250 (31.75)	.856 (21.74)	.608 (15.44)	.364 (9.25)
1-602180-3	1.644 (41.76)	1.484 (37.69)	1.250 (31.75)	.856 (21.74)	.398 (10.11)	.324 (8.23)
1-602180-4	1.572 (39.93)	1.412 (35.86)	1.250 (31.75)	.856 (21.74)	.326 (8.28)	.257 (6.53)
1-602180-5	1.503 (38.18)	1.343 (34.11)	1.250 (31.75)	.856 (21.74)	.258 (6.55)	.204 (5.18)
1-602180-6	1.444 (36.68)	1.284 (32.61)	1.250 (31.75)	.856 (21.74)	.198 (5.03)	.162 (4.11)
<b>1192.5 kcmil Range Taps (Yellow Coded)</b>						
602300	2.604 (66.14)	2.516 (63.91)	1.375 (34.93)	.856 (21.74)	1.375 (34.93)	.856 (21.74)
602300-1	2.548 (64.72)	2.448 (62.18)	1.375 (34.93)	.856 (21.74)	1.375 (34.93)	.856 (21.74)
602300-2	2.498 (63.45)	2.398 (60.91)	1.375 (34.93)	.856 (21.74)	1.375 (34.93)	.856 (21.74)
602300-3	2.410 (61.21)	2.310 (58.67)	1.375 (34.93)	.856 (21.74)	1.375 (34.93)	.856 (21.74)
602300-4	2.353 (59.77)	2.253 (57.23)	1.375 (34.93)	.856 (21.74)	1.375 (34.93)	.856 (21.74)
602300-5	2.292 (58.22)	2.192 (55.68)	1.375 (34.93)	.856 (21.74)	1.375 (34.93)	.856 (21.74)
602300-6	2.229 (56.62)	2.129 (54.08)	1.375 (34.93)	.856 (21.74)	1.375 (34.93)	.856 (21.74)
602300-7	2.160 (54.86)	2.060 (52.32)	1.375 (34.93)	.856 (21.74)	.900 (22.86)	.700 (17.78)
602300-8	2.085 (52.96)	1.985 (50.42)	1.375 (34.93)	.856 (21.74)	.900 (22.86)	.700 (17.78)
602300-9	2.023 (51.38)	1.923 (48.84)	1.375 (34.93)	.856 (21.74)	.750 (19.05)	.525 (13.34)
1-602300-0	1.944 (49.38)	1.844 (46.84)	1.375 (34.93)	.856 (21.74)	.722 (18.34)	.525 (13.34)
1-602300-1	1.865 (47.37)	1.765 (44.83)	1.375 (34.93)	.856 (21.74)	.608 (15.44)	.364 (9.25)
1-602300-2	1.804 (45.82)	1.704 (43.28)	1.375 (34.93)	.856 (21.74)	.608 (15.44)	.364 (9.25)
1-602300-3	1.749 (44.42)	1.649 (41.88)	1.375 (34.93)	.856 (21.74)	.608 (15.44)	.364 (9.25)
1-602300-4	1.701 (43.21)	1.601 (40.67)	1.375 (34.93)	.856 (21.74)	.398 (10.11)	.324 (8.23)
1-602300-5	1.627 (41.33)	1.527 (38.79)	1.375 (34.93)	.856 (21.74)	.326 (8.28)	.257 (6.53)
1-602300-6	1.559 (39.60)	1.459 (37.06)	1.375 (34.93)	.856 (21.74)	.258 (6.55)	.204 (5.18)
1-602300-7	1.500 (38.10)	1.400 (35.56)	1.375 (34.93)	.856 (21.74)	.198 (5.03)	.162 (4.11)

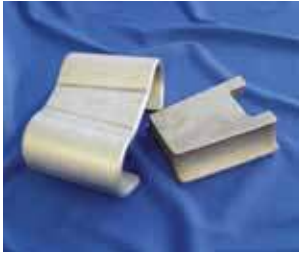

C\_ampact\_el

## AMPACT EL

AMPACT EL connectors are designed for use on a larger conductor that is used on transmission lines. AMPACT EL connectors can be used in high voltage applications up to 230 kV. 500 kV lines will require a corona ring. AMPACT EL connectors can be used on solid and stranded aluminum, aluminum alloy and stranded aluminum composite conductors including AAC, AAAC, ACSR, ACAR, AW, ACSR/AW and ACSS. Below are conductor combinations already available. Contact your TE representatives for your individual needs.

### Selection Information

Catalog Number	Connector Description	Sum of Diameter	Large Groove	Small Groove
1443208-1	2500 AAC - 2500 AAC	3.648	1.824	1.824
1443209-1	1351.5 ACSR (54/19)-636 ACSR (26/7)	2.414	1.424	.099
109423-1	1590 AAC (61)-795 AAC (61)	2.482	1.454	1.028
276915-1	1590 ACSR (45/7)-1590 ACSR (45/7)	3.008	1.504	1.504
81673-1	1590 ACSR (45/7)-1272 ACSR (45/7)	2.849	1.504	1.345
81673-2	1590 ACSR (45/7)-795 ACSR (45/7)	2.567	1.504	1.063
81673-3	1590 ACSR (45/7)-336.4 ACSR (26/7)	2.225	1.504	0.721
83086-1	1590 ACSR (45/7)-336 ACSR (26/7)	2.225	1.504	0.721
83086-2	1590 ACSR (45/7)-4/0 AAC (SOL)	1.964	1.504	0.460
109424-1	1351.5 ACSR (54/19)-1351.5 ACSR (54/19)	2.848	1.424	1.424
109703-1	1351.5 ACSR (54/19)-397.5 ACSR (18/1)	2.167	1.424	0.743
276548-1	1843.2 ACSR (72/7)-795.5 ACSR (27/7)	2.712	1.604	1.108
602080-0	2500 AAC (X)-500 AAC (19), 500 CU (19)	2.635 2.634	1.824	0.811 0.810
602080-1	2500 AAC (X)-500 AAC (19), 500 CU (19)	2.635 2.634	1.824	0.811 0.810
109433-1	1272 ACSR (45/7)-954 ACSR (45/7)	2.510	1.345	1.165
276300-1	1272 ACSR (45/7), (36/1)-1272 ACSR (45/7), (36/1)	2.690 2.632	1.345 1.316	1.345 1.316
1443268-1	1272 ACSR (54/19)-1272 ACSR (54/19)	2.764	1.382	1.382
	850 mm <sup>2</sup> HAL-660 mm <sup>2</sup> HAL*	2.799	1.488	1.311
81698-1	2167 ACSR (72/7)-556.5 ACSR (24/7)	2.651	1.737	0.914
83861-1	143 AAC (61)-1272 ACSR (45/7)	2.724	1.379	1.345
1443259-1	1351.5 ACSR (54/19)-397.5 ACSR (18/1)	2.167	1.424	0.743

\*Use yellow cartridge 69338-4, HAL - Hard Drawn Aluminum, use AMPACT tool 69611 to apply taps  
Contact your TE sales representative for additional sizes.



C\_ampact\_hht

## AMPACT HTT High Temperature Tap

To provide a new family of wedge technology products suitable for use on ACSS overhead lines operating at temperatures up to 250°C, TE Connectivity has developed a new contact-aid compound (corrosion inhibitor). This inhibitor compound is capable of sealing the electrical contact area of the connectors while exposed to high operating temperatures. This new compound is incorporated in TE's AMPACT HTT (high temperature tap), expanding the AMPACT connector family of products to provide increased reliability of connectors for ACSS applications.

- Synthetic lubricant will not degrade insulating materials. It is safe to use and will not damage conductor insulation.
- Integrated, large, hard, conductive metal alloy particles scrub the conductor during wedge travel, so the conductor is abraded during the connection installation process.
- Metal-to-metal contact areas are established and sealed.
- Wedge technology combined with a proprietary high-temperature corrosion inhibitor enhances connector reliability on ACSS conductors.
- Exceeds ANSI C119.4 AA standard current cycling test specifications
- Meets mechanical pull test and corrosion requirements
- Accommodates a wide range of cable diameters
- AMPACT HTT are installed with standard AMPACT tools.
- HT Inhibitor may be purchased separately for any HT application.

### Selection Information

Catalog Number	Description	Size
1443316-2	AMPACT High Temperature Inhibitor	1-pound cartridge



C\_Stirrups

## Stirrups

- Easy to install with AMPACT tooling
- Heavy duty, tin plated copper bail
- No damage to conductors when removed
- Connects almost all solid, stranded or compressed conductor combinations

### Selection Information

Catalog Number	Conductor Range Size	ACSR, AAC Conductor	Standard Bail	Part Number	Cartridge Color
602585	Type II	#6	No. 2	69338-5	White
602586	Type II	#4, #2	No. 2	69338-5	White
1443312-1	Medium	#4, #2	No. 2	69338-1	Blue
600464	Medium	1/0 or 2/0	No. 2	69338-1	Blue
275436-1	Medium	1/0 or 2/0	1/0	69338-1	Blue
600468	Medium	2/0 or 3/0	No. 2	69338-1	Blue
600469	Medium	3/0 or 4/0	No. 2	69338-1	Blue
275435-1	Medium	3/0 or 4/0	1/0	69338-1	Blue
602173	Medium	3/0 or 4/0	2/0	69338-1	Blue
600463	Medium	266.8	No. 2	69338-1	Blue
602201	Medium	266.8	1/0	69338-1	Blue
602502	Medium	350 AAC	1/0	69338-1	Blue
276478-1	Medium	350 AAC	No. 2	69338-1	Blue
600474	Large	336.4	1/0	69338-4	Yellow
602142	Large	336.4	2/0	69338-4	Yellow
602136	Large	336.4	4/0	69338-4	Yellow
602047	Large	397.5 or 477	1/0	69338-4	Yellow
602143	Large	397.5 or 477	2/0	69338-4	Yellow
602247	Large	397.5 or 477	4/0	69338-4	Yellow
602104	Large	556.5	1/0	69338-4	Yellow
602248	Large	556.5	2/0	69338-4	Yellow
602115	Large	556.5	4/0	69338-4	Yellow
602174	Large	636	2/0	69338-4	Yellow
602162	Large	795	2/0	69338-4	Yellow
602163	Large	795	4/0	69338-4	Yellow
602237	Large	1033.5	4/0	69338-4	Yellow





C\_ampact\_StudDisc

## AMPACT Stud Disconnect System

Separable connections in the utility industry exist wherever maintenance must be performed. Common practice in many utilities is to use a stirrup connector and hot-line clamp. This practice is not acceptable in high current applications due to current limitations of the hot-line clamp and stirrup bail.

Attached to the circuit conductor using the AMPACT tap, a two-hole NEMA lug can be bolted to the disconnect in either orientation. The disconnect is then plugged onto the stud with hot-sticks or rubber gloves and connected/disconnected in seconds with a few turns of the eyebolt. The stud can be assembled to the line pointing up or down as required.

- Standard NEMA pad allows use of any size jumper conductor
- Can be easily removed in seconds
- Rated for 750 amps continuous current for demanding applications
- Lug can be attached in either orientation for maximum application flexibility
- System tested to ANSI C119.4
- Stud locking feature allows safe removal and easy hot-stick application
- Easy to park on standard parking stud

The AMPACT stud disconnect is an addition to the proven wedge pressure system that utilities around the world have counted on for over thirty years.

### Technical Documents

Instruction Sheet	408-9968
Engineering Test Report	502-47000

### Selection Information (Use of kits is highly recommended.)

Kit	Part Number
Replacement Disconnect	83471-1
Replacement Stud	83396-1

Conductors Accommodated	Complete Kit	Kit with Stud w/o Disconnect	Appropriate AMPACT Tap Only
1/0 AAC, ACSR to 4/0 ACSR, AAC	83470-1	83452-1	1-602031-7
266.8 AAC, ACSR to 336.4 AAC, ACSR	83470-2	83452-2	1-602031-5
477.0 AAC, ACSR to 556.5 AAC, ACSR	83470-3	83452-3	1-602031-3
795.0 AAC, ACSR	83470-4	83452-4	602121-5



C\_IDplates

## Identifier Plates

TE's Identifier (ID) Plate can be installed on primary or secondary distribution conductors for field identification of circuits and/or switches. The improved identification accuracy can contribute to safer operation of line apparatus especially in congested circuits or multiple switch locations. The AMPACT connectors have been incorporated into the Identifier Plate design creating simple efficient application with the AMPACT tool and cartridge. The lightweight aluminum construction enables easy installation with hot-sticks or rubber gloves. The proven mechanical connection provided by TE's wedge-pressure connectors will not damage the conductor. The vibration resistant connection reduces the possibility of radio frequency interference.

The ID Plate is angled for easier viewing from the ground. Its flat, black anodized surface provides a sharp contrast to the alpha-numeric characters that can be applied to its surface. (Alpha-numeric symbols not supplied with plate).

- Angled for easy viewing from ground
- Reduces radio frequency interference
- Lightweight
- Applied with AMPACT tool or standard wrench
- Circuit Identification
- Phase Marking
- Switch Identification
- All aluminum construction, black anodized

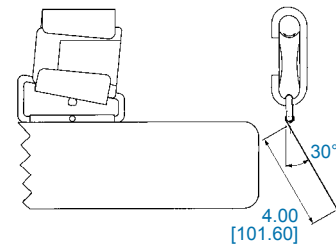

### Selection Information

Part Number	Fits
w/AMPACT Connector	Conductor
83005-4	#2-1/0
83005-1	2/0-4/0 AWG
83005-5	4/0-266.8
83005-2	336.4-556.5 AAC
83005-3	795 AAC, ACSR

Plate width – 4.00 (101.60),  
Plate length – 15.50 (393.70).

Note: Alpha-numeric characters not supplied with ID plate.



C\_ampact\_Deadend

## AMPACT Deadend Clamp Assembly

The AMPACT deadend clamp connector assembly has been designed to simplify installation and to provide superior performance. Standard AMPACT tooling and standard utility construction procedures are used to install the AMPACT deadend clamp connector assembly either by hand (rubber gloves) or with hot-sticks. A quick visual inspection of the lance on the end of the wedge is a positive verification of a proper installation, eliminating the need for torque wrenches or other special tooling.

The AMPACT deadend clamp connector assembly is offered as a Straight Deadend, Deadend Clamp with 3/4 [19.05] Jumper Stud, or Deadend Clamp with 2/0 Bail. Use of the AMPACT deadend clamp connector assembly with Jumper Stud or Bail eliminates the need for a separate electrical connection to the conductor. TE's proven wedge pressure technology and components manufactured from selected aluminum alloys are combined to create a Deadend Clamp that exceeds the mechanical and electrical industry standards.

The "C" and "wedge" components come with factory applied inhibitor to enhance continued contact integrity. The AMPACT deadend clamp connector assembly fits standard stranded, All Aluminum Conductors (AAC) and Aluminum Stranded Conductors (ASC), in sizes 266.8, 336.4, 477.0, and 556.5 kcmil.

The pulling eye, an integral part of the Deadend body, is rated at 6,000 lbs, while the Deadend body is rated at 10,000 lbs. The "C" and "wedge" components are not reusable. Replacement "wedge" and "C" components can be obtained by contacting your local TE Connectivity representative.

- Installed with standard AMPACT tools
- Simple hot-stick application
- Available as a mechanical or combination mechanical and electrical termination
- Wedge pressure technology
- Positive visual inspection
- Removable without damage to conductor
- Exceeds CSA C83.71-M87 Standard for Deadend Clamps
- Exceeds the electrical and mechanical requirements of ANSI C119.4 and CSA C57 standards

### Technical Documents

Instruction Sheet	408-9988
Engineering Test Report	502-47001

### Performance Characteristics

Pulling Eye Strength	6,000 lbs. [26,690 N]
Deadend Body Strength	10,000 lbs. [44,480 N]

### Selection Information

Style	Fits Conductor (AAC/ACSR) <sup>1</sup>	Catalog Number
Deadend Clamp	266.8	83589-1
	336.4	83589-2
	477.0	83589-3
	556.5	83589-4
	795 ACC	83589-6
	795 ACSR / 954 AAC	83589-7
	Deadend Clamp w/Jumper Stud <sup>2</sup> (3/4 [19.05] Plated Cu)	266.8
336.4		83590-2
477.0		83590-3
556.5		83590-4
Deadend Clamp w/Stirrup (2/0 Plated Cu Bail)	266.8	83591-1
	336.4	83591-2
	477.0	83591-3
	556.5	83591-4

1. Designed to fit AAC/ACSR standard stranded conductor.

2. For additional information refer to AMPACT Stud Disconnect System.

Note: The "C" and "wedge" components are not reusable. Contact your local TE representative for replacement "C" and "wedge" components or for part numbers to connect wire types/sizes not shown.



C\_ampact\_ILD

## AMPACT In-Line Disconnect Switch (ILD-II) 15 kV to 69 kV Class

The AMPACT In-Line Disconnect Switch (ILD II) combines the reliability of copper blade components and a double string of polymeric insulators with the AMPACT deadend yoke assembly. The result is an in-line disconnect that can be installed without the need for tensioning devices.

The proven performance of AMPACT deadend technology has been utilized in the design of the AMPACT In-Line Disconnect Switch (ILD II). The deadend yokes are bolted to (2) two polymeric insulators. The copper blade assembly is connected to the AMPACT deadend yoke assembly between and below the double string of insulators. This provides adequate space for cutting the conductor after installation of the AMPACT deadend taps.

Standard AMPACT tap application procedures are used to make both electrical and mechanical connections simultaneously. The AMPACT In-Line Disconnect Switch (ILD II) can be installed on standard stranded all aluminum conductors (AAC) or aluminum conductor steel reinforced (ACSR) in conductor sizes from 1/0 to 954. In addition to its original function to help install the switch on the conductor, the uniquely designed eye keeper doubles as a mechanical clamp to increase the conductor pulling-out strength in excess of 7500 lb without slipping or damage to conductor.

The integral pulling eye on the body of the AMPACT deadend yoke assembly is provided to the attachment of line tensioning devices if removal of the AMPACT in-line disconnect switch is required. The tensile rating of the pulling eye is 6,000 lbs, while the AMPACT deadend yoke assembly is rated at 10,000 lbs tensile. Electrical ratings are provided in the performance characteristic tables.

The unique AMPACT In-Line Disconnect design allows for positioning of cutters between the double insulator assembly. The conductor can be cut between the AMPACT deadend yoke assemblies and the ends bent back, or if using the new keepers, it can be cut flush on each end.

- Installation with standard AMPACT tooling
- Quick, easy manual or hot-stick application
- Both mechanical and electrical connection made simultaneously with the AMPACT tap
- No line tensioning devices required for installation
- Double string of polymeric insulators prevents rolling of the switch
- Copper disconnect blade assembly suspended below the insulators simplifying the cutting of conductor

### Performance Characteristics

Voltage: 15 kV (110 kV BIL), 29 kV (150 kV BIL), 35 kV (200 kV BIL), 46 kV (250 BIL), 69 kV (350 kV BIL)

Current: 900 and 1200 Amps

Frequency: 60Hz

Momentary Current: 40,000 Amps

Short Time Current: 25,000 Amps, 3 sec.

### Technical Documents

Instruction Sheet: PII 56078

Engineering Test Report: 502-47376

### Approvals

RUS Listed

ANSI: C119.4, C37.32, C37.34

IEEE: C37.30

CSA: C83.71

Selection Information

	ACSR	AAC	Replacement	BIL with Taps - <i>without Taps</i>				
				15 kV, 110 kV	29 kV, 150 kV	35 kV, 200 kV	46 kV, 250 kV	69 kV, 350 kV
X-Small	1/0 <sup>6</sup> / <sub>1</sub> 2/0 <sup>6</sup> / <sub>1</sub>	1/0	1-83843-0	1710723-1* <b>1710722-1*</b>	1710727-1* <b>1710726-1*</b>	1710731-1* <b>1710730-1*</b>	-	-
				1710725-1** <b>1710724-1**</b>	1710729-1** <b>1710728-1**</b>	1710733-1** <b>1710732-1**</b>		
Small	3/0 <sup>6</sup> / <sub>1</sub> 4/0 <sup>6</sup> / <sub>1</sub>	4/0	83843-7	1710723-2* <b>1710722-2*</b>	1710727-2* <b>1710726-2*</b>	1710731-2* <b>1710730-2*</b>	1710735-1 <b>1710734-1</b>	1710737-1 <b>1710736-1</b>
				1710725-2** <b>1710724-2**</b>	1710729-2** <b>1710728-2**</b>	1710733-2** <b>1710732-2**</b>		
	266.8 <sup>18</sup> / <sub>1</sub>	266.8	83843-1	1710723-3* <b>1710722-2*</b>	1710727-3* <b>1710726-2**</b>	1710731-3* <b>1710730-2*</b>	1710735-2 <b>1710734-1</b>	1710737-2 <b>1710736-1</b>
				266.8 <sup>26</sup> / <sub>7</sub> 336.4 <sup>18</sup> / <sub>1</sub> , <sup>26</sup> / <sub>7</sub> , <sup>30</sup> / <sub>7</sub>	397.5 336.4 350	83843-2	1710723-4* <b>1710722-2*</b>	1710727-4* <b>1710726-2*</b>
397.5 <sup>18</sup> / <sub>1</sub> , <sup>24</sup> / <sub>7</sub> , <sup>26</sup> / <sub>7</sub> , <sup>30</sup> / <sub>7</sub> 477.0 <sup>18</sup> / <sub>1</sub>	450 477 500	83843-3	1710723-5* <b>1710722-3*</b>	1710727-5* <b>1710726-3*</b>	1710731-5* <b>1710730-3*</b>		1710735-4 <b>1710734-2</b>	1710737-4 <b>1710736-2</b>
			1710725-5** <b>1710724-3**</b>	1710729-5** <b>1710728-3**</b>	1710733-5** <b>1710732-3**</b>			
Large	477.0 <sup>26</sup> / <sub>7</sub> 556.5 <sup>18</sup> / <sub>1</sub>	556.5	83843-4	1710723-6* <b>1710722-3*</b>	1710727-5* <b>1710726-3*</b>	1710731-6* <b>1710730-3*</b>	1710735-5 <b>1710734-2</b>	1710737-5 <b>1710736-2</b>
				1710725-6** <b>1710724-3**</b>	1710729-5** <b>1710728-3**</b>	1710733-6** <b>1710732-3**</b>		
X-Large	477.0 <sup>30</sup> / <sub>7</sub> 556.5 <sup>24</sup> / <sub>7</sub> , <sup>26</sup> / <sub>7</sub> , <sup>30</sup> / <sub>7</sub> 605 <sup>24</sup> / <sub>7</sub> , <sup>26</sup> / <sub>7</sub> 636 <sup>18</sup> / <sub>1</sub> , <sup>36</sup> / <sub>1</sub>	600 636 650 700	83843-5	1710723-7* <b>1710722-4*</b>	1710727-7* <b>1710726-4*</b>	1710731-7* <b>1710730-4*</b>	1710735-6 <b>1710734-3</b>	1710737-6 <b>1710736-3</b>
				1710725-7** <b>1710724-4**</b>	1710729-7** <b>1710726-4**</b>	1710733-7** <b>1710732-4**</b>		
	605 <sup>30</sup> / <sub>19</sub> 636 <sup>26</sup> / <sub>7</sub> , <sup>24</sup> / <sub>7</sub> , <sup>30</sup> / <sub>19</sub> 666.6 <sup>24</sup> / <sub>7</sub> , <sup>26</sup> / <sub>7</sub> 795 <sup>36</sup> / <sub>1</sub> , <sup>42</sup> / <sub>7</sub> , <sup>45</sup> / <sub>7</sub>	715.5 750 795	83843-6	1710723-8* <b>1710722-4*</b>	1710727-8* <b>1710728-4*</b>	1710731-8* <b>1710730-4*</b>	1710735-7 <b>1710734-3</b>	1710737-7 <b>1710736-3</b>
				1710725-8** <b>1710724-4**</b>	1710729-8** <b>1710728-4**</b>	1710733-8** <b>1710732-4**</b>		
	795 <sup>24</sup> / <sub>7</sub> , <sup>26</sup> / <sub>7</sub> <sup>30</sup> / <sub>7</sub> , <sup>30</sup> / <sub>19</sub> , <sup>54</sup> / <sub>7</sub>	954	1-83843-1	1710723-9* <b>1710722-4*</b>	1710727-9* <b>1710726-4*</b>	1710731-9* <b>1710730-4*</b>	1710735-8 <b>1710734-3</b>	1710737-8 <b>1710736-3</b>
				1710725-9** <b>1710724-4**</b>	1710729-9** <b>1710728-4**</b>	1710733-9** <b>1710732-4**</b>		

\*K-line insulators and S&C blades

\*\*Victor insulators and Royal blades

Note: For hot-stick work you will need the following: "C" and Wedge Holder 69900, Piggy Back Clamp 69883



C\_Terminal Lugs

## Terminal Lugs

- Easy to install with AMPACT tooling
- Use as disconnectable tap or jumper connection
- Controlled contact pressure
- Easily removable and relocated
- Aluminum alloy models
- Terminal pads have NEMA drilled bolt patterns
- Use on overhead or pad mounted transformers

### Bolt Hole Patterns

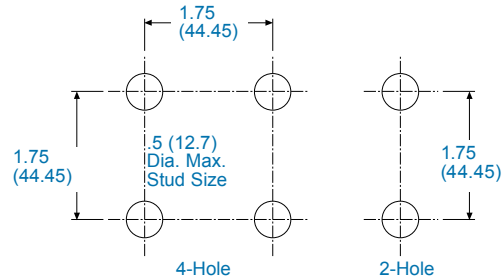

### Selection Information

Paddle Type	Shank Size Conductor	(Tap Groove)	Ampacity*	Catalog Number
2-Hole Paddle	#2 thru #6 1/0 thru 4/0 266.8 kcmil	4/0 Str	610	602089
2-Hole Paddle	336.4, 397.5, 477, 556.5 kcmil 636, 795, 954, 1033.5 kcmil	336.4 Str 397.5 795 Str	895 895 1400	602097 569398-1** 602285
4-Hole Paddle	#2 thru #6 1/0 thru 4/0 266.8 kcmil	4/0 Str	610	602091
4-Hole Paddle	336.4, 397.5, 477, 556.5 kcmil 636, 795, 954, 1033.5 kcmil	336.4 Str 795 Str	895 1400	602099 602286
4-Hole Flag	336.4, 397.5, 477, 556.5 kcmil 636, 795, 954, 1033.5 kcmil	336.4 Str 795 Str	895 1400	602093 602287

\*Current-carrying capacity in amperes at 90°C  
IS 408-2116

\*\*569398-1 has longer shank



C\_TapCovers\_URD

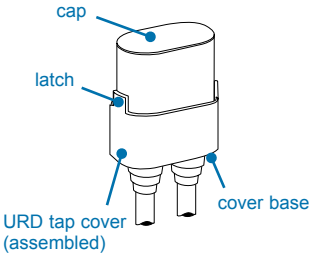

## Tap Covers for Underground Residential Distribution (URD)

AMPACT tap covers, combined with the standard AMPACT tap, provide an effective method of making an insulated moisture-proof connection. This connection is designed for use in direct burial and ducted installations, above or below grade, in various types of soil and in various climates.

The tap cover is a two-piece molded plastic cover consisting of a cover base and a cap. The cap contains a row of notches on each side to mate with latches on the cover base which contains a piston and the sealing compound. Projecting from the cover base are one or two reducers that may be trimmed to conform to the variety of sizes of insulated conductors. As the cover is closed, the latches engage the notches and the piston forces the sealing compound around the insulated conductor, sealing the connection. This sealing action protects the connection from oxidation and corrosion.

### Selection Information (dimensions shown in inches/millimeters)

Catalog Number	Size	Conductor Insulation Dia Range	Conductor Strip Length
602179	Small	.200-.500 (5.08-12.7)	1.5 (38.1)
602178	Medium	.300-.820 (7.62-20.8)	2.37 (60.3)

Note: Refer to Instruction Sheet IS 2584 for application instructions.



C\_GelPactCovers

## GelPact Covers AMPACT Taps

TE's Raychem GelPact covers provide corrosion protection for AMPACT aluminum taps in severely corrosive environments such as coastal or heavily polluted areas. GelPact covers will prevent corrosion from forming on newly installed AMPACT taps in aerial applications. For previously installed AMPACT taps, installing a GelPact cover will help to arrest the progress of any corrosion that might be forming in the tap.

Made of sturdy, black, UV stable plastic. GelPact covers are provided in packs of 18 for white and blue and in packs of 12 for yellow. These covers are ready to snap on quickly and start providing corrosion protection for your electrical network. GelPact cover kits feature revolutionary PowerGel sealing gel which provides an excellent moisture seal over a wide temperature range (-40°C to 105°C). PowerGel sealing gel offers excellent insulating properties and acts as a vibration damper, as well.

Just three sizes of GelPact covers accommodate the entire AMPACT tap product line. GelPact W-sized covers fit all white coded taps. GelPact B-sized fits all blue-coded AMPACT taps, while GelPact SMY-sized covers fit 336 up to 605 mcm.

### Selection Information

Catalog Number	Product Description
1710523-1	Gelpact B fits all blue connectors #6 - 4/0
1710501-1	Gelpact SMY fits all yellow connectors 336 - 605
1710500-1	Gelpact W fits all white connectors #6 - 1/0



C\_TapCovers

## Tap Covers

These tap covers are used to electrically insulate AMPACT taps from neighboring taps, exposed ground conductors, or nearby grounded structures in 600-volt maximum, insulated-conductor overhead applications.

### Selection Information

Tap Size	Color Code	Strip Style	Cover Length*	Catalog Number
Type II	White	Hinged Top 82.6	3.25	83364-1
Medium 266.8 and 350	Blue	Hinged Top 108	4.25	602080
336.4, 477 and 556.5	Yellow	Hinged Top 152	6	602107
795 and 1033.5	Yellow	2 Half Sections 165	6.5	602284

\*Nominal strip length of insulation on through and tap conductors IS 408-2137

Type II covers will fit MINIWEDGE connectors as well.



C\_AMPACT tool

## AMPACT Tool

- Lightweight powder-actuated tools require minimum operator effort
- Installs and removes taps even in confined spaces
- Adaptable for standard hot-stick use
- Conductor applications imprinted on tap packages
- Packages and labels color coded to match taps to tools and cartridges

### Selection Information

Catalog Number	Description	Connects
69437	Small AMPACT Tool (For Red-, White-, and Blue-coded taps)	Aluminum Wire Combinations: #8 — 350 kcmil
69611	Large AMPACT Tool (For Yellow-coded taps only)	Aluminum Wire Combinations: 336.4 — 1192.5, AMPACT EL tap connectors

### Using the AMPACT tool with the Hot Stick

1. Position “piggyback” clamp onto wire.  
“C” member hooked onto the wire

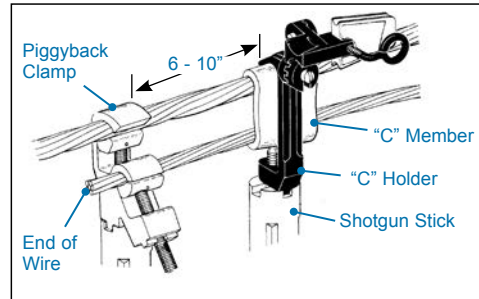

2. Wedge is placed in “C” member.

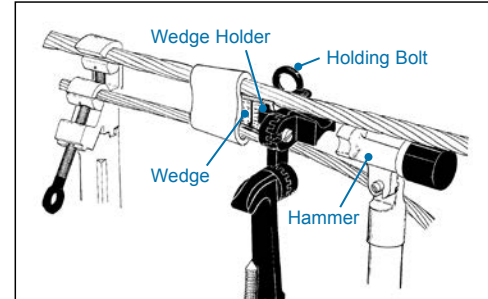

3. AMPACT tool clamped over the tap.

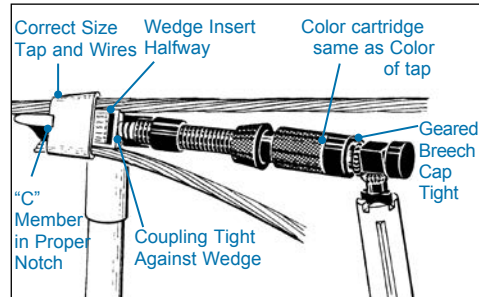

4. Tap is completed by hammer blow to end of tool.

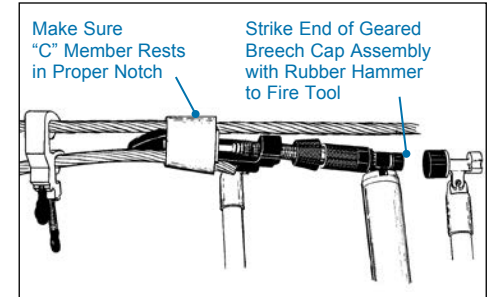

### Replacement Parts

Catalog Number	Description
69633-2	Large Tool Head
47667-8	Small Tool Head
69612	Universal Power Unit
308967-1	Breech Assembly
314196-1	Breech Cap Assembly (3-Pc)
5-304668-3	Retaining Spring



69633-2



47667-8



69612



308967-1



314196-1, 5-304668-3



C\_ampact\_EZload

## AMPACT EZ Load Wedge Installation Tool

The AMPACT EZ LOAD tool is a precision designed, powder actuated tool that is robust yet lightweight. The tool is designed with a lock and load approach. This all in one design hinges on the power unit and is easily opened and closed to replace the cartridges. AMPACT tools are engaged by firing a special powder loaded cartridge within the tool which reduces the time and effort required to tap a power line.

AMPACT cartridges are color-coded (red etc.) and designed specifically for use in the AMPACT EZ LOAD tools to install AMPACT taps. The cartridges are molded of weatherproof polyethylene and packed with propellant and primer. The color of the cartridge indicates the strength of the powder charge and corresponds to the color-code of tap sizes with which they are used.

The compact tools are manufactured in high-grade steel to precise tolerances and are available in two sizes: large head and small head. The same interchangeable power unit is used in both tools.

### Selection Information

Catalog Number	Description
1443413-2	AMPACT EZ LOAD Power k Adapter
1443514-1	AMPACT EZ LOAD Hot-Stick Adapter Kit (includes Piercer pin guide and cover)
1443470-1	AMPACT EZ LOAD Hot-Stick Adapter with Power Unit
1443442-1	AMPACT EZ LOAD Cleaning tool
1443448-1	AMPACT EZ LOAD Tool repair kit (included Piercer Pin guide, Piercer pin and grub screw)
69610-2	Hot-stick Kit for EZ Load tool



C\_ampact\_cartridges

## Cartridges

Catalog Number	Description
69338-5	White
69338-2	Red
69338-1	Blue
69338-4	Yellow



80665-2

C\_ampact\_inhibitor

## Inhibitor Compound and NEMA Interface Hinge

Catalog Number	Description
80665-3	8 oz. (236 ml) plastic bottle aluminum inhibitor compound
80665-2	1 qt (.95 litre) can aluminum inhibitor compound
561118-1*	2-Hole NEMA interface hinge to protect against corrosion between dissimilar metals

\*IS 408-2556



80665-3



561118-1



C\_cleaningtool

## Cleaning Tool

Part Number	Description
314199-1	Cleaning Tool



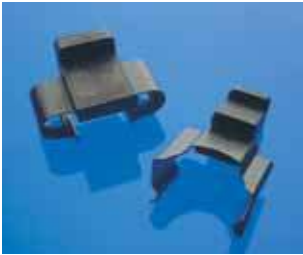

C\_takeoffclip

## Take-Off Clip

### Catalog

Number	Description
69685-1*	For Blue-Coded Taps (and White-Coded Copper Taps)
69684	For Red-Coded Taps
69947	For Type II White-Coded Taps
69847	For Yellow-Coded Taps

\*IS 408-2589

Note: Refer to Customer Manual 409-2106 for AMPACT tap removal.



C\_platform

## Auxillary Platform

### Catalog

Number	Description
306814	Auxillary Platform

Notes:

1. Part No. 69437 includes Take-off Clips, Part Nos. 69947 and 69685-1
2. Part No. 69611 includes Take-off Clip, Part No. 69847
3. Auxiliary Platform Part No. 306814-3 is required to install red-coded standard taps with Small AMPACT Tool.
4. Refer to Customer Manual 409-2106 for instructions on AMPACT connector installation and removal.  
IS 408-9494 (P/N 314199-1), IS 408-9907 (P/N 69611 and 69437), IS 408-1201 (P/N 69437)



C\_bags

## Accessory Bag

### Catalog

Number	Size	Description
608338-1	12.5 (317.4) tall, 7 (177.8) dia.	Open type, brass snap-on swivel hook, white canvas
607501-1	12.5 (317.4) tall, 7 (177.8) dia.	Open type, brass snap-on swivel hook
608877-1		AMPACT Tool Kit Box

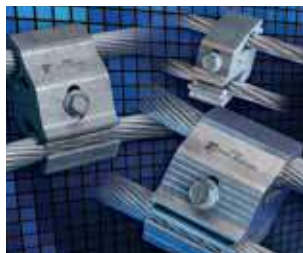

C\_TWC

## Transverse Wedge Connectors

Transverse Wedge Connectors (TWC) represent the second generation of Wedge Pressure Technology developed by the company that introduced Wedge Pressure Technology with the AMPACT connector system. The TWC family provides superior wedge performance and reliability with greater conductor range accommodation – without the need for special application tooling.

The TWC product line has a unique application method. The connector is hooked over both conductors and then closed. As the user tightens the fastener, the interlocking wedges create deflection in the two independent “J” members. Once the wedges bottom out, the “J” members provide consistent contact force regardless of the amount of torque required to close the connector. There is no torque specification for the TWC product line.

Qualified to ANSI Class AA, the TWC does not require special application tooling.

### Selection Information

#### Catalog

Number	Description
2182075-1	TWC Hotstick Kit East Coast Universal Connect includes Sockets
2182076-1	TWC Hotstick Kit West Coast Quick connect includes Sockets

AA Cover	1710837-1
25-Pack	1710837-2
50-Pack	1710837-3

BB Cover	1710839-1
25-Pack	1710839-2
50-Pack	1710839-3

Transverse Wedge Connector 6 to 266.8

Tap Conductor AWG & kcmil		Main Conductor AWG & kcmil						
		266.8 <sup>18/1</sup> ACSR, 266.8	4/0, 3/0 AAC, 250	3/0 ACC, ACSR	1/0 Solid, 2/0	2	4	6
		AA4 Large	AA3 Large Groove	AA2 Large Large	AA1 Small Small	AA1 Small Small	AA2 Small Small	AA3 Small Groove
6	AA3 Small Groove	1710705-9 (AA4-AA3)	1710705-8 (AA3-AA3)	1710705-6 (AA3-AA2)	1710705-3 (AA3-AA1)	1710705-3 (AA3-AA1)	1710705-6 (AA3-AA2)	1710705-8 (AA3-AA3)
4	AA2 Small Groove	1710705-7 (AA4-AA2)	1710705-6 (AA3-AA2)	1710705-5 (AA2-AA2)	1710705-2 (AA2-AA1)	1710705-2 (AA2-AA1)	1710705-5 (AA2-AA2)	
2	AA1 Small Groove	1710705-4 (AA4-AA1)	1710705-3 (AA3-AA1)	1710705-2 (AA2-AA1)	1710705-1 (AA1-AA1)	1710705-1 (AA1-AA1)		
1/0	AA1 Large Groove	1710705-4 (AA4-AA1)	1710705-3 (AA3-AA1)	1710705-2 (AA2-AA1)	1710705-1 (AA1-AA1)			
2/0, 3/0 ACC, Solid	AA2 Large Groove	1710705-7 (AA4-AA2)	1710705-6 (AA3-AA2)	1710705-5 (AA2-AA2)				
3/0 ACSR, 4/0	AA3 Large Groove	1710705-9 (AA4-AA3)	1710705-8 (AA3-AA3)					
250, 226.8, ACC, 266.8 <sup>18/1</sup> , ACSR	AA4	1-1710705-0 (AA4-AA4)						

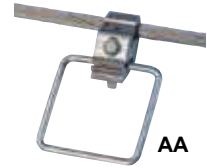

Conductor Diameter Range (inches)		
"J" Member	Stranded	Solid
AA3 Small Groove	.182-.222	.122-.162
AA2 Small Groove	.222-.274	.162-.214
AA1 Small Groove	.274-.338	.214-.278
AA1 Large Groove	.338-.413	.278-.353
AA2 Large Groove	.413-.488	.353-.428
AA3 Large Groove	.488-.563	.428-.503
AA4	.563-.613	.503-.553

Transverse Wedge Strirrups - 226 Series						
Catalog Number	"J" Member	Range (kcmil)	Ball Size (AWG)	Ampacity*		
1710813-1	AA1	2 & 1/0	2	340**		
1710813-2	AA2	4 & 2/0 to 3/0 AAC	2	340**		
1710813-3	AA3	6 & 3/0 ACSR to 4/0	2	340**		
1710813-4	AA4	250 to 266.8 (18/1) ACSR	2	340**		
1710813-5	AA1	2 & 1/0	1/0	550		
1710813-6	AA2	4 & 2/0 to 3/0 AAC	1/0	550		
1710813-7	AA3	6 & 3/0 ACSR to 4/0	1/0	550		
1710813-8	AA4	250 to 266.8 (18/1) ACSR	1/0	550		

Transverse Wedge Connector 6 to 600

Tap Conductor AWG & kcmil		Main Conductor AWG & kcmil				
		600, 566.5	550, 500, 477	450, 400, 397.5	350, 336.4, 300 <sup>24/7</sup> , ACSR	300 <sup>18/1</sup> , ACSR, 300, ACC 266.8, 250
		BB8	BB7	BB6	BB5	BB4
6	BB3 Small Groove	1-1710802-5 (BB8-BB3)	1-1710802-4 (BB7-BB3)	1-1710802-3 (BB6-BB3)	1-1710802-2 (BB5-BB3)	1-1710802-1 (BB4-BB3)
4	BB2 Small Groove	1-1710802-0 (BB8-BB2)	1710802-9 (BB7-BB2)	1710802-8 (BB6-BB2)	1710802-7 (BB5-BB2)	1710802-6 (BB4-BB2)
2	BB1 Small Groove	1710802-5 (BB8-BB1)	1710802-4 (BB7-BB1)	1710802-3 (BB6-BB1)	1710802-2 (BB5-BB1)	1710802-1 (BB4-BB1)
1/0	BB1 Large Groove	1710802-5 (BB8-BB1)	1710802-4 (BB7-BB1)	1710802-3 (BB6-BB1)	1710802-2 (BB5-BB1)	1710802-1 (BB4-BB1)
2/0, 3/0 ACC, Solid	BB2 Large Groove	1-1710802-0 (BB8-BB2)	1710802-9 (BB7-BB2)	1710802-8 (BB6-BB2)	1710802-7 (BB5-BB2)	1710802-6 (BB4-BB2)
3/0 ACSR, 4/0	BB3 Large Groove	1-1710802-5 (BB8-BB3)	1-1710802-4 (BB7-BB3)	1-1710802-3 (BB6-BB3)	1-1710802-2 (BB5-BB3)	1-1710802-1 (BB4-BB3)
250, 266.8, 300 AAC, 300 <sup>18/1</sup> , ACSR	BB4	2-1710802-0 (BB8-BB4)	1-1710802-9 (BB7-BB4)	1-1710802-8 (BB6-BB4)	1-1710802-7 (BB5-BB4)	1-1710802-6 (BB4-BB4)
300 <sup>24/7</sup> , ACSR, 336.4, 350	BB5	2-1710802-4 (BB8-BB5)	2-1710802-3 (BB7-BB5)	2-1710802-2 (BB6-BB5)	2-1710802-1 (BB5-BB5)	
397.5, 400, 450	BB6	2-1710802-7 (BB8-BB6)	2-1710802-6 (BB7-BB6)	2-1710802-5 (BB6-BB6)		
477, 500, 550	BB7	2-1710802-9 (BB8-BB7)	2-1710802-8 (BB7-BB7)			
556.5, 600	BB8	3-1710802-0 (BB8-BB8)				

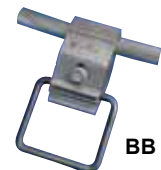

Conductor Diameter Range (inches)		
"J" Member	Stranded	Solid
BB3 Small Groove	.182-.222	.122-.162
BB2 Small Groove	.222-.274	.162-.214
BB1 Small Groove	.274-.338	.214-.278
BB1 Large Groove	.338-.413	.278-.353
BB2 Large Groove	.413-.488	.353-.428
BB3 Large Groove	.488-.563	.428-.503
BB4	.563-.663	.503-.603
BB5	.654-.750	.594-.690
BB6	.721-.821	.661-.761
BB7	.790-.890	.730-.830
BB8	.853-.953	.793-.893

Transverse Wedge Strirrups - 600 Series					
Catalog Number	"J" Member	Range (kcmil)	Ball Size (AWG)	Ampacity*	
1710814-1	BB4	250 to 300 (18/1) ACSR	2	340**	
1710814-2	BB4	250 to 300 (18/1) ACSR	1/0	550	
1710814-3	BB5	300 (24/7) ACSR to 350	1/0	550	
1710814-4	BB5	397.5 to 450	1/0	550	
1710814-5	BB7	477 to 550	1/0	550	
1710814-6	BB8	556.5 to 636 AAC	2/0	700	
1710814-7	BB5	300 (24/7) ACSR to 350	2/0	700	
1710814-8	BB6	397.5 to 450	2/0	700	
1710814-9	BB7	477 to 550	2/0	700	
1-1710814-0	BB8	556.6 to 636 AAC	2/0	700	
1-1710814-1	BB8	556.6 to 636 ACC	4/0	850	

Transverse Wedge Connector 6 to 1192

Tap Conductor AWG & kcmil		Main Conductor AWG & kcmil					
		1192.5, 1113 ACSR	1113 AAC, 1100, 1033.5	1000, 954	900, 800	795, 715.5 ACSR	750, 715.5 AAC, 700, 650, 636
		CC14	CC13	CC12	CC11	CC10	CC9
6	CC3 Small Groove	1-1710889-8 (CC14-CC3)	1-1710889-7 (CC13-CC3)	1-1710889-6 (CC12-CC3)	1-1710889-5 (CC11-CC3)	1-1710889-4 (CC10-CC3)	1-1710889-3 (CC9-CC3)
4	CC2 Small Groove	1-1710889-2 (CC14-CC2)	1-1710889-1 (CC13-CC2)	1-1710889-0 (CC12-CC2)	1710889-9 (CC11-CC2)	1710889-8 (CC10-CC2)	1710889-7 (CC9-CC2)
2	CC1 Small Groove	1710889-6 (CC14-CC1)	1710889-5 (CC13-CC1)	1710889-4 (CC12-CC1)	1710889-3 (CC11-CC1)	1710889-2 (CC10-CC1)	1710889-1 (CC9-CC1)
1/0	CC1 Large Groove	1710889-6 (CC14-CC1)	1710889-5 (CC13-CC1)	1710889-4 (CC12-CC1)	1710889-3 (CC11-CC1)	1710889-2 (CC10-CC1)	1710889-1 (CC9-CC1)
2/0, 3/0 AAC	CC2 Large Groove	1-1710889-2 (CC14-CC2)	1-1710889-1 (CC13-CC2)	1-1710889-0 (CC12-CC2)	1710889-9 (CC11-CC2)	1710889-8 (CC10-CC2)	1710889-7 (CC9-CC2)
3/0 ACSR, 4/0	CC3 Large Groove	1-1710889-8 (CC14-CC3)	1-1710889-7 (CC13-CC3)	1-1710889-6 (CC12-CC3)	1-1710889-5 (CC11-CC3)	1-1710889-4 (CC10-CC3)	1-1710889-3 (CC9-CC3)
250, 266.8, 300 AAC, 300 <sup>18/11</sup> , ACSR	CC4	2-1710889-4 (CC14-CC4)	2-1710889-3 (CC13-CC4)	2-1710889-2 (CC12-CC4)	2-1710889-1 (CC11-CC4)	2-1710889-0 (CC10-CC4)	1-1710889-9 (CC9-CC4)
300 <sup>24/7</sup> , ACSR, 336.4, 350	CC5	3-1710889-0 (CC14-CC5)	2-1710889-9 (CC13-CC5)	2-1710889-8 (CC12-CC5)	2-1710889-7 (CC11-CC5)	2-1710889-6 (CC10-CC5)	2-1710889-5 (CC9-CC5)
397.5, 400, 450	CC6	3-1710889-6 (CC14-CC6)	3-1710889-5 (CC13-CC6)	3-1710889-4 (CC12-CC6)	3-1710889-3 (CC11-CC6)	3-1710889-2 (CC10-CC6)	3-1710889-1 (CC9-CC6)
477, 500, 550	CC7	4-1710889-2 (CC14-CC7)	4-1710889-1 (CC13-CC7)	4-1710889-0 (CC12-CC7)	3-1710889-9 (CC11-CC7)	3-1710889-8 (CC10-CC7)	3-1710889-7 (CC9-CC7)
556.5, 600,	CC8	4-1710889-8 (CC14-CC8)	4-1710889-7 (CC13-CC8)	4-1710889-6 (CC12-CC8)	4-1710889-5 (CC11-CC8)	4-1710889-4 (CC10-CC8)	4-1710889-3 (CC9-CC8)
636, 650, 700, 715.5 AAC, 750	CC9	5-1710889-4 (CC14-CC9)	5-1710889-3 (CC13-CC9)	5-1710889-2 (CC12-CC9)	5-1710889-1 (CC11-CC9)	5-1710889-0 (CC10-CC9)	4-1710889-9 (CC9-CC9)
715.5 ACSR, 795	CC10	5-1710889-9 (CC14-CC10)	5-1710889-8 (CC13-CC10)	5-1710889-7 (CC12-CC10)	5-1710889-6 (CC11-CC10)	5-1710889-5 (CC10-CC10)	
800, 900	CC11	6-1710889-3 (CC14-CC11)	6-1710889-2 (CC13-CC11)	6-1710889-1 (CC12-CC11)	6-1710889-0 (CC11-CC11)		
954, 1000	CC12	6-1710889-6 (CC14-CC12)	6-1710889-5 (CC13-CC12)	6-1710889-4 (CC12-CC12)			
1033.5, 1100 1113 AAC	CC13	6-1710889-8 (CC14-CC13)	6-1710889-7 (CC13-CC13)				
1113 ACSR, 1192.5	CC14	6-1710889-9 (CC14-CC14)					



"J" Member	Conductor Diameter Range (inches)	
	Stranded	Solid
CC3 Small Groove	.182-.222	.122-.162
CC2 Small Groove	.222-.274	.162-.214
CC1 Small Groove	.274-.338	.214-.278
CC1 Large Groove	.338-.413	.278-.353
CC2 Large Groove	.413-.488	.353-.428
CC3 Large Groove	.488-.563	.428-.503
CC4	.563-.663	.503-.603
CC5	.654-.750	.594-.690
CC6	.721-.821	.661-.761
CC7	.790-.890	.730-.830
CC8	.853-.953	.793-.893
CC9	.918-1.019	
CC10	1.008-1.108	
CC11	1.100-1.162	
CC12	1.124-1.196	
CC13	1.172-1.255	
CC14	1.255-1.338	

Transverse Wedge Strirrups - 1192 Series						
Catalog Number	"J" Member	Range (kcmil)	Ball Size (AWG)	Ampacity*		
1710905-1	CC9	636 ACSR to 715.5 AAC	2/0	700		
1710905-2	CC10	795 AAC to 795 (26/7) ACSR	2/0	700		
1710905-3	CC12	954 AAC to 954 (48/7) ACSR	2/0	700		
1710905-5	CC9	636 ACSR to 715.5 AAC	4/0	850		
1710905-6	CC10	795 AAC to 795 (26/7) ACSR	4/0	850		
1710905-7	CC11	795 (30/7) ACSR to 900	4/0	850		
1710905-8	CC12	954 AAC to 954 (48/7) ACSR	4/0	850		
1710905-9	CC13	1033.5 to 1113 AAC	4/0	850		
1-1710905-0	CC14	1113 ACSR to 1272 AAC	4/0	850		

\*Current carrying capacity in amperes at 90°C, based upon largest current-carrying conductor ampacity of ball alone is twice that of copper conductor of same size.



C\_HotStick

## Hot-Stick

This revolutionary tap installation method cuts down lineman exposure to energized lines. Using this unique tool, the AMPACT tap system is adaptable for use with standard hot sticks. With a simple hot stick adapter kit, the standard glove method is converted to the fastest hot-stick method available. The hot stick kit allows linemen to work in line with conductors instead of across them. And the same tools are used whether working from pole, board or bucket, and when installing or removing tap.

Adapts AMPACT tools to standard commercial hot stick equipment. The kit handles AMPACT taps and stirrups from No. 8 to 556.5-27/7 ACSR. (With additional components, it can be used on conductors to 1192.5-45/7 ACSR.) For additional information contact your TE representative.

### Selection Information

Part Number 69610-1. The kit consists of the following items, which also can be ordered separately:

Item	Part Number	Description
Geared Breech	306347-1	Replaces standard breech cap assembly Cap Assembly and enables power unit to be tightened against wedge by simply turning stick.
90° Adapter	69833-1	Attaches tool holders to universal hot stick, and wedge holder to "C" holder. Two adapters are included.
Small Tool Holder	306349-2	Holds small AMPACT tool No. 69437 with universal hot stick.
Large Tool Holder	306349-1	Holds large AMPACT tool No. 69611 with universal hot stick.
"C" Holder	306350-2	Used to hold the "C" member with shotgun stick, and to hook over the through and tap conductors.
Wedge Holder	306348-1	Used to hold wedge with universal hot stick.
Piggyback Clamp	69816	Used to hold tap conductor in position with through conductor
Adapter	1443514-1	Hot-Stick EZ Load adapter

Accessories must be ordered separately from Hot-Stick Kit. Required for taps and stirrups in 795.0 to 1192.5 kcmil range.

Item	Part Number
"C" and Wedge Holder	69900
Piggyback Clamp	69883

*Note: This clamp is not intended for continuous electrical service.*



306347-1



69833-1



306349-2



306349-1



306350-2



306348-1



69816



69674



69900



69883



1443514-1



C\_Miniwedge

## Service Entrance Connector System

### MINIWEDGE Connectors

MINIWEDGE connectors incorporate wedge pressure technology to provide an easily applied and reliable aluminum-to-aluminum/aluminum-to-copper connection for service entrance and street light applications. The color-coded packaging simplifies connector selection for terminating standard stranded and compacted ACSR, AAAC, AAC and copper conductors.

MINIWEDGE connectors are for service entrance applications from #6 to #2 through 2/0 to 4/0. To enhance the mechanical and electrical performance of the service entrance connector, the AMP GEO-TAC surface is added to the inside of the "C" component during the manufacturing process. The GEO-TAC surface provides superior grip on the conductor to overcome the possibility of failure due to vibration and also increases the contact surface for greater electrical performance under changing load conditions.

MINIWEDGE connectors are also offered for typical street light applications for a range of sizes to connect from #14, #12, and #10 street light tap wire up to a 336.4 thru conductor. The designed controlled force exerted by the MINIWEDGE connector does not damage the conductor and it can be easily removed without loss of cable length.

MINIWEDGE connectors offer simple installations anytime, anywhere, without the need for special tools and complicated die selection. The aluminum alloy "C" and wedge components are installed with parallel jaw pliers. A quick visual inspection of the locking tab in the inspection window verifies the connection is complete and ready for installation of the insulated cover, if required. Factory applied inhibitor is applied to all MINIWEDGE connectors to prolong the life of the connection in its service environment.

- No special tools
- Removable without conductor loss or damage
- Unique GEO-TAC surface in "C" provides higher tensile and vibration resistance
- Conductor range #14 AWG to 336.4 kcmil
- Service entrance and street light applications
- Separate insulating covers
- Color-coded for easy connector selection
- Wedge pressure reliability
- Aluminum to aluminum, aluminum to copper
- Suitable for guy, messenger and fence grounding (not for direct burial)

#### Approvals

- UL Listed
- Meets ANSI C119.4
- Part Number Series 83623 and 83630 are Certified by Canadian Standards Association, File No. LR 7189
- RUS

*Note: MINIWEDGE connectors are not recommended for copper-to-copper connections. The MINIWEDGE connector with GHFC MW cover is pictured.*



Parallel Jaw Pliers  
109717-1

Note: For Copper to Copper applications contact your TE Representative.

**Special Triplex**

Full ACSR, AAAC or AAC neutral  
Full AAC hot wires



		1/0	#2	#4	#6
		1/0 ACSR, AAAC 1/0 AAC, Cu Str 1/0 AAC/Cu cmpt #2 Sol	#2 ACSR, AAAC #2 AAC, Cu Str #2 AAC/Cu cmpt #6 Sol, #4 Sol	#4 ACSR, AAAC #4 AAC, Cu Str #4 AAC/Cu cmpt	#6 ACSR, AAAC #6 AAC, Cu Str #6 AAC/Cu cmpt
#6	#6 AAC, Cu Str #6 ACSR, AAAC #6 Sol, #4 Sol	83592-4	83592-7	83592-9	1-83592-0
#4	#4 AAC, Cu Str #4 ACSR, AAAC #2 Sol	83592-3	83592-6	83592-8	
#2	#2 AAC, Cu Str #2 ACSR, AAAC	83592-2	83592-5		
1/0	1/0 ACSR, AAAC 1/0 AAC	83592-1			

**Standard Triplex**

Full ACSR, AAAC or AAC neutral  
Full AAC hot wires



		4/0	3/0	2/0
		4/0 ACSR, AAAC 4/0 AAC, Cu Str 4/0 AAC cmpt	3/0 ACSR, AAAC 3/0 AAC, Cu Str 3/0 AAC cmpt	2/0 ACSR, AAAC 2/0 AAC, Cu Str
#2	#2 AAC, Cu Str #2 ACSR, AAAC	83631-1	83631-4	83631-7
1/0	1/0 AAC 1/0 ACSR, AAAC 2/0 AAC cmpt	83631-2	83631-5	83631-8
2/0	2/0 AAC 2/0 ACSR, AAAC	83631-3	83631-6	83631-9

**Special Triplex (Smooth Body)**

Full AAC or cmpt ACSR neutral  
Full AAC or cmpt AAC hot wires



		1/0 (S.B.)	#2 (S.B.)	#4	#6
		1/0 ACSR cmpt 1/0 AAC, Cu Str 1/0 AAC/Cu cmpt	#2 ACSR cmpt #2 AAC, Cu Str #2 AAC/Cu cmpt #2 Sol#6 Sol, #4 Sol	#4 ACSR cmpt #4 AAC, Cu Str #4 AAC/Cu cmpt	#6 ACSR cmpt #6 AAC/Cu cmpt #6 AAC, Cu Str
#6	#6 AAC, Cu Str #6 ACC cmpt #6 ACSR cmpt #6 Sol, #4 Sol	83592-4	83592-7	83592-9	1-83592-0
#4	#4 AAC, Cu Str #4 AAC cmpt #4 ACSR cmpt #2 Sol	83592-3	83592-6	83592-8	
#2 (S.B.)	#2 AAC, Cu Str #2 AAC cmpt #2 ACSR cmpt	1-83592-2	1-83592-3		
1/0 (S.B.)	1/0 AAC 1/0 AAC cmpt 1/0 ACSR cmpt 2/0 AAC cmpt	1-83592-1			

Note: For Copper to Copper applications contact your TE Representative.

**Special Triplex (Smooth Body)**  
Full AAC or cmpt ACSR neutral  
Full AAC or cmpt AAC hot wires



		4/0 (S.B.)	3/0 (S.B.)	2/0 (S.B.)
		4/0 ACSR cmpt 4/0 AAC, Cu Str 4/0 AAC cmpt	3/0 ACSR cmpt 3/0 AAC, Cu Str 3/0 AAC cmpt	2/0 ACSR cmpt 2/0 AAC, Cu Str 2/0 AAC cmpt
#2 (S.B.)	#2 AAC cmpt #2 AAC, Cu Str #2 ACSR cmpt	1-83631-1	1-83631-4	1-83631-7
1/0 (S.B.)	1/0 AAC cmpt 1/0 AAC 1/0 ACSR cmpt	1-83631-2	1-83631-5	1-83631-8
2/0 (S.B.)	2/0 AAC cmpt 2/0 AAC 2/0 ACSR cmpt 1/0 ACSR, AAAC	1-83631-3	1-83631-6	1-83631-9

**Small Street Light Tap**

		1/0	#2	#4	#6	#8
		1/0 ACSR, AAAC 1/0 AAC, Cu Str 1/0 AAC/Cu cmpt 2/0 AAC/Cu cmpt	#2 ACSR, AAAC #2 AAC, Cu Str #2 AAC/Cu cmpt #2 Sol	#4 ACSR, AAAC #4 AAC, Cu Str #4 AAC/Cu cmpt #6 Sol, #4 Sol	#6 ACSR, AAAC #6 AAC, Cu Str #6 AAC/Cu cmpt	#8 AAC/Cu Str #8 Al/Cu Sol #6 Al/Cu Sol
#s 10, 12, 14	#14 Al/Cu Str & Sol #12 Al/Cu Str & Sol #10 Al/Cu Str & Sol	83630-1	83630-3	83630-5	83630-7	83630-9
#8	#8 AAC/Cu Str #8 Al/Cu Sol #6 Al/Cu Sol	83630-2	83630-4	83630-6	83630-8	1-83630-0

**Large Asymmetrical Street Light Tap**

		336.4	266.8	4/0	3/0	2/0
		336.4 AAC 266.8 ACSR (18/1) 266.8 ACSR (26/7)	266.8 ACSR (18/1) 266.8 AAC 336.4 AAC cmpt	4/0 ACSR 4/0 AAC/3/0 AAC 266.8 AAC cmpt	3/0 ACSR 2/0 AAC 4/0 AAC cmpt	2/0 ACSR 3/0 AAC cmpt
#s 10, 12, 14	#14 Al/Cu Str & Sol #12 Al/Cu Str & Sol #10 Al/Cu Str & Sol	1-83623-7	1-83623-3	83623-9	83623-5	83623-1
#8	#8 AAC/Cu Str & Sol #6 Al/Cu Sol	1-83623-8	1-83623-4	1-83623-0	83623-6	83623-2
#6	#6 AAC/Cu Str & Sol #6 ACSR #4 Al/Cu Sol	1-83623-9	1-83623-5	1-83623-1	83623-7	83623-3
#4	#4 AAC/Cu Str #4 ACSR #2 Al/Cu Sol	2-83623-0	1-83623-6	1-83623-2	83623-8	83623-4

## MINIWEDGE Connectors

## Selection Information by Wire Diameter Limits: dimensions shown in inches (millimeters)

Catalog Numbers	Wire Marking		Sum of Diameters		Groove 1 Diameter		Groove 2 Diameter	
	Groove 1	Groove 2	Max.	Min.	Max.	Min.	Max.	Min.
<b>Core</b>								
83592-1	1/0	1/0	.796 (20.22)	.696 (17.68)	.398 (10.11)	.315 (8.00)	.398 (10.11)	.315 (8.00)
83592-2	1/0	#2	.723 (18.36)	.618 (15.70)	.398 (10.11)	.315 (8.00)	.336 (8.53)	.260 (6.60)
83592-3	1/0	#4	.656 (16.66)	.549 (13.94)	.398 (10.11)	.315 (8.00)	.268 (6.81)	.205 (5.21)
83592-4	1/0	#6	.602 (15.29)	.498 (12.65)	.398 (10.11)	.315 (8.00)	.215 (5.46)	.138 (3.51)
83592-5	#2	#2	.650 (16.51)	.550 (13.97)	.336 (8.53)	.260 (6.60)	.336 (8.53)	.260 (6.60)
83592-6	#2	#4	.583 (14.81)	.481 (12.22)	.336 (8.53)	.260 (6.60)	.268 (6.81)	.205 (5.21)
83592-7	#2	#6	.529 (13.44)	.429 (10.90)	.336 (8.53)	.260 (6.60)	.215 (5.46)	.138 (3.51)
83592-8	#4	#4	.516 (13.11)	.416 (10.57)	.268 (6.81)	.205 (5.21)	.268 (6.81)	.205 (5.21)
83592-9	#4	#6	.462 (11.73)	.362 (9.19)	.268 (6.81)	.205 (5.21)	.215 (5.46)	.138 (3.51)
1-83592-0	#6	#6	.408 (10.36)	.308 (7.82)	.215 (5.46)	.138 (3.51)	.215 (5.46)	.138 (3.51)
1-83592-1	1/0 SB	1/0 SB	.752 (19.10)	.652 (16.56)	.398 (10.11)	.315 (8.00)	.398 (10.11)	.315 (8.00)
1-83592-2	1/0 SB	#2 SB	.670 (17.02)	.570 (14.48)	.398 (10.11)	.315 (8.00)	.336 (8.53)	.260 (6.60)
1-83592-3	#2 SB	#2 SB	.600 (15.24)	.500 (12.70)	.336 (8.53)	.260 (6.60)	.336 (8.53)	.260 (6.60)
<b>Service Connectors</b>								
83631-1	4/0	#2	.888 (22.56)	.788 (20.02)	.570 (14.48)	.473 (12.01)	.336 (8.53)	.260 (6.60)
83631-2	4/0	1/0	.961 (24.41)	.861 (21.87)	.570 (14.48)	.473 (12.01)	.398 (10.11)	.315 (8.00)
83631-3	4/0	2/0	1.010 (25.65)	.907 (23.04)	.570 (14.48)	.473 (12.01)	.470 (11.94)	.375 (9.53)
83631-4	3/0	#2	.827 (21.01)	.731 (18.57)	.515 (13.08)	.420 (10.67)	.336 (8.53)	.260 (6.60)
83631-5	3/0	1/0	.900 (22.86)	.809 (20.55)	.515 (13.08)	.420 (10.67)	.398 (10.11)	.315 (8.00)
83631-6	3/0	2/0	.949 (24.10)	.849 (21.56)	.515 (13.08)	.420 (10.67)	.470 (11.94)	.375 (9.53)
83631-7	2/0	#2	.772 (19.61)	.682 (17.32)	.470 (11.94)	.375 (9.53)	.336 (8.53)	.260 (6.60)
83631-8	2/0	1/0	.845 (21.46)	.760 (19.30)	.470 (11.94)	.375 (9.53)	.398 (10.11)	.315 (8.00)
83631-9	2/0	2/0	.894 (22.71)	.800 (20.32)	.470 (11.94)	.375 (9.53)	.470 (11.94)	.375 (9.53)
1-83631-1	4/0 SB	#2 SB	.820 (20.83)	.720 (18.29)	.570 (14.48)	.473 (12.01)	.336 (8.53)	.260 (6.60)
1-83631-2	4/0 SB	1/0 SB	.901 (22.89)	.811 (20.60)	.570 (14.48)	.473 (12.01)	.398 (10.11)	.315 (8.00)
1-83631-3	4/0 SB	2/0 SB	.942 (23.93)	.851 (21.62)	.570 (14.48)	.473 (12.01)	.470 (11.94)	.375 (9.53)
1-83631-4	3/0 SB	#2 SB	.756 (19.20)	.660 (16.76)	.515 (13.08)	.420 (10.67)	.336 (8.53)	.260 (6.60)
1-83631-5	3/0 SB	1/0 SB	.837 (21.26)	.759 (19.28)	.515 (13.08)	.420 (10.67)	.398 (10.11)	.315 (8.00)
1-83631-6	3/0 SB	2/0 SB	.878 (22.30)	.799 (20.29)	.515 (13.08)	.420 (10.67)	.470 (11.94)	.375 (9.53)
1-83631-7	2/0 SB	#2 SB	.706 (17.93)	.620 (15.75)	.470 (11.94)	.375 (9.53)	.336 (8.53)	.260 (6.60)
1-83631-8	2/0 SB	1/0 SB	.787 (19.99)	.700 (17.78)	.470 (11.94)	.375 (9.53)	.398 (10.11)	.315 (8.00)
1-83631-9	2/0 SB	2/0 SB	.828 (21.03)	.740 (18.80)	.470 (11.94)	.375 (9.53)	.470 (11.94)	.375 (9.53)
<b>Large Asymmetrical Street Light</b>								
2-83623-0	336.4	#4	.924 (23.47)	.822 (20.88)	.675 (17.15)	.590 (14.99)	.268 (6.81)	.205 (5.21)
1-83623-9	336.4	#6	.870 (22.10)	.771 (19.58)	.675 (17.15)	.590 (14.99)	.215 (5.46)	.138 (3.51)
1-83623-8	336.4	#8	.828 (21.03)	.725 (18.42)	.675 (17.15)	.590 (14.99)	.198 (5.03)	.115 (2.92)
1-83623-7	336.4	#10 - #14	.782 (19.86)	.673 (17.09)	.675 (17.15)	.590 (14.99)	.125 (3.18)	.055 (1.40)
1-83623-6	266.8	#4	.867 (22.02)	.788 (20.02)	.620 (15.75)	.540 (13.72)	.268 (6.81)	.205 (5.21)
1-83623-5	266.8	#6	.813 (20.65)	.737 (18.72)	.620 (15.75)	.540 (13.72)	.215 (5.46)	.138 (3.51)
1-83623-4	266.8	#8	.771 (19.58)	.691 (17.55)	.620 (15.75)	.540 (13.72)	.198 (5.03)	.115 (2.92)
1-83623-3	266.8	#10 - #14	.725 (18.42)	.639 (16.23)	.620 (15.75)	.540 (13.72)	.125 (3.18)	.055 (1.40)
1-83623-2	4/0	#4	.821 (20.85)	.720 (18.29)	.570 (14.48)	.473 (12.01)	.268 (6.81)	.205 (5.21)
1-83623-1	4/0	#6	.767 (19.48)	.669 (16.99)	.570 (14.48)	.473 (12.01)	.215 (5.46)	.138 (3.51)
1-83623-0	4/0	#8	.725 (18.42)	.623 (15.82)	.570 (14.48)	.473 (12.01)	.198 (5.03)	.115 (2.92)
83623-9	4/0	#10 - #14	.679 (17.25)	.571 (14.50)	.570 (14.48)	.473 (12.01)	.125 (3.18)	.055 (1.40)
83623-8	3/0	#4	.760 (19.30)	.662 (16.81)	.515 (13.08)	.420 (10.67)	.268 (6.81)	.205 (5.21)
83623-7	3/0	#6	.706 (17.93)	.611 (15.52)	.515 (13.08)	.420 (10.67)	.215 (5.46)	.138 (3.51)
83623-6	3/0	#8	.664 (16.87)	.565 (14.35)	.515 (13.08)	.420 (10.67)	.198 (5.03)	.115 (2.92)
83623-5	3/0	#10 - #14	.618 (15.70)	.513 (13.03)	.515 (13.08)	.420 (10.67)	.125 (3.18)	.055 (1.40)
83623-4	2/0	#4	.705 (17.91)	.613 (15.57)	.470 (11.94)	.375 (9.53)	.268 (6.81)	.205 (5.21)
83623-3	2/0	#6	.651 (16.54)	.562 (14.27)	.470 (11.94)	.375 (9.53)	.215 (5.46)	.138 (3.51)
83623-2	2/0	#8	.609 (15.47)	.516 (13.11)	.470 (11.94)	.375 (9.53)	.198 (5.03)	.115 (2.92)
83623-1	2/0	#10 - #14	.563 (14.30)	.464 (11.79)	.470 (11.94)	.375 (9.53)	.125 (3.18)	.055 (1.40)
<b>Small Street Light</b>								
83630-1	1/0	#10 - #14	.514 (13.06)	.400 (10.16)	.398 (10.11)	.315 (8.00)	.125 (3.18)	.055 (1.40)
83630-2	1/0	#8	.560 (14.22)	.460 (11.68)	.398 (10.11)	.315 (8.00)	.198 (5.03)	.115 (2.92)
83630-3	#2	#10 - #14	.441 (11.20)	.332 (8.43)	.336 (8.53)	.260 (6.60)	.125 (3.18)	.055 (1.40)
83630-4	#2	#8	.487 (12.37)	.384 (9.75)	.336 (8.53)	.260 (6.60)	.198 (5.03)	.115 (2.92)
83630-5	#4	#10 - #14	.374 (9.50)	.274 (6.96)	.268 (6.81)	.205 (5.21)	.125 (3.18)	.055 (1.40)
83630-6	#4	#8	.420 (10.67)	.320 (8.13)	.268 (6.81)	.205 (5.21)	.198 (5.03)	.115 (2.92)
83630-7	#6	#10 - #14	.320 (8.13)	.220 (5.59)	.215 (5.46)	.138 (3.51)	.125 (3.18)	.055 (1.40)
83630-8	#6	#8	.366 (9.30)	.266 (6.76)	.215 (5.46)	.138 (3.51)	.198 (5.03)	.115 (2.92)
83630-9	#8	#10 - #14	.278 (7.06)	.178 (4.52)	.198 (5.03)	.115 (2.92)	.125 (3.18)	.055 (1.40)
1-83630-0	#8	#8	.324 (8.23)	.224 (5.69)	.198 (5.03)	.115 (2.92)	.198 (5.03)	.115 (2.92)





C\_GHFC\_MW

## GHFC MW Closure

### Gel Cover for Use with MINIWEDGE Connectors

The Raychem GHFC MW closure was specifically designed to provide sealing and corrosion protection for MINIWEDGE connectors installed overhead for corrosion protection or in direct buried applications up to 1000 volts. In either case, it is as easy as simply snapping the closure over the connector.

Suitable for aluminum-to-aluminum and aluminum-to-copper connections. Fits most MINIWEDGE connector applications.

#### Selection Information: dimensions shown in inches (millimeters)

Catalog Number	Description	Main	Tap	Std. Pack
GHFC-MW	Gel cover for sealing and insulating	#8-4/0 (10-95)	#14-2/0 (1.5-70)	10

#### Ordering Information

1. Package does not contain MINIWEDGE connectors, which must be ordered separately
2. Standard package: 10 kits/box
3. Related test reports: EDR-5340, 502-47233



C\_ampact\_Coppertaps

## AMPACT Copper Wire Taps

AMPACT copper taps are used when you need a permanent connection. They resist corrosion and will not loosen. The unique design, incorporating a tapered “C” member and wedge, permits easy installation in only a fraction of the time required for conventional crimp-type or molded joints.

The tap's “C” member is composed of an aluminum bronze alloy and the wedge of a copper alloy very close to pure copper. Built-in spring tension causes the tap to maintain constant mechanical pressure for optimum electrical conductivity. The taps will provide secure connections on both stranded wire or solid rod.

When properly matched and applied, AMPACT taps exceed the current-carrying capacity of the conductors they are connecting. A locking tab prevents the tapered locked wedge from loosening once it has been driven into position. Taps stay permanently locked during power surges, yet may be removed if necessary without damage to cables or rods. To make operations even easier, AMPACT taps may be visually inspected by verifying wedge position and locking tab. Installers can check the connection immediately — speeding application.



Listed by Underwriters Laboratories Inc., File No. E69905



Certified by Canadian Standards Association, File No. LR 56476

REA Letter of Technical Acceptance (Grounding Taps)

- Unique design provides firm, sure contact for consistent, all weather, wire-to-wire, low resistance grounding connections
- Compact, lightweight application tool permits easy installation almost anywhere, without bulky equipment, heat, or external power
- Simple installation system greatly reduces exposure to energized lines
- Connectors may be checked visually — speeding inspection and practically eliminating callbacks
- Electrical joints are stable and effective for optimum electrical contact, even under conditions of creep and cold flow
- Taps will not penetrate copper plating, allowing secure connections from copper conductors to ground rods, reinforcing bars or conductors of any type
- AMPACT copper taps are made of quality alloys for low resistivity and superior corrosion resistance

### Technical Documents

Customer Manual	409-2106
Department Publications	410-5810, 410-5811
Product Specifications	108-13011, 108-13012, 108-13015
Safety Publication	125-6217
General Publication	408-3010-1 through -4, GP 1931

### AMPACT Copper Wire Tap Selection Information

Groove Size kcmil or AWG	Groove Code	Conductor Diameter	
		Minimum	Maximum
500	A	.785 (19.9)	.813 (20.7)
450	B	.745 (18.9)	.784 (19.9)
400	E	.700 (17.8)	.744 (18.9)
350	G	.650 (16.5)	.699 (17.8)
300	H	.620 (15.7)	.649 (16.5)
250	K (R)††	.561 (14.2)	.625 (15.9)
4/0	L	.506 (12.9)	.560 (14.2)
3/0	M	.451 (11.5)	.505 (12.8)
2/0	N	.401 (10.2)	.450 (11.4)
1/0	O	.355 (9.0)	.400 (10.2)
No. 2	T	.280 (7.1)	.354 (9.0)
No. 4	W	.216 (5.5)	.279 (7.1)
No. 6	X	.182 (4.6)	.215 (5.5)

††250 kcmil groove is identified with the letter “K” when paired with 300 through 500 kcmil grooves, and with letter “R” when paired with No. 6 AWG through 250 kcmil grooves.

### Ground Rod Applications Copper-Clad

Designated Size	Wire Size	Actual Diameter
3/8 (9.53)	1/0 AWG	.355 (9.02)
1/2 (12.70)	3/0 AWG	.475 (12.06)
5/8 (15.88)	250 kcmil	.563 (14.30)
3/4 (19.05)	350 kcmil	.682 (17.32)

### Galvanized Steel

Designated Size	Wire Size	Actual Diameter
3/8 (9.53)	1/0 AWG	.375 (9.53)
1/2 (12.70)	3/0 AWG	.500 (12.70)
5/8 (15.88)	300 kcmil	.625 (15.88)
3/4 (19.05)	450 kcmil	.750 (19.05)

AMPACT Copper Tap Selection for Wire to Ground Rod† or Solid Pin

Copper Conductor (kcmil/AWG)	3/8"	1/2"	5/8"		3/4"	
	Ground Rod/Pin Dia. Range .355-.375 (9.02-9.53)	Ground Rod/Pin Dia. Range .475-.500 (12.07-12.7)	Ground Rod Diameter .563 (14.3)	Ground Rod/Pin Diameter .625 (15.88)	Ground Rod Diameter .682 (17.32)	Ground Rod/Pin Diameter .750 (19.05)
500	1-276337-4	1-276337-3	276337-9	1-276337-2	1-276337-1	276337-1
450	2-276337-5	2-276337-4	2-276337-3	2-276337-2	2-276337-1	1-276337-9
400	3-276337-7	3-276337-5	3-276337-3	3-276337-2	3-276337-1	2-276337-0
350	4-276337-9	4-276337-7	4-276337-5	4-276337-4	4-276337-3	2-276337-1
300	6-276337-0	5-276337-8	5-276337-6	5-276337-5	4-276337-4	2-276337-2
250	275187-4	275187-2	2-275187-8	5-276337-6	4-276337-5	2-276337-3
4/0	275187-9	275187-7	275187-1	5-276337-7	4-276337-6	276337-2
3/0	1-275187-3	1-275187-1	275187-2	5-276337-8	4-276337-7	2-276337-4
2/0	1-275187-6	1-275187-2	275187-3	5-276337-9	4-276337-8	276337-3
1/0	1-275187-8	1-275187-3	275187-4	6-276337-0	4-276337-9	2-276337-5
No. 2	277060-1	1-275187-4	275187-5	6-276337-2	5-276337-1	276337-4
No. 4	277060-1	3-275187-6	3-275187-0	6-276337-4	5-276337-3	2-276337-8
No. 6	277060-2	3-275187-7	3-275187-1	6-276337-5	5-276337-4	2-276337-9

†Some Ground Rods have a designated or descriptive diameter that is different from the Actual Diameter. The Actual Diameter must be determined and used with the top chart for correct tap selection.

AMPACT Copper Tap Selection for Wire-to-Wire Applications

Typical Example:  
500 to 350 kcmil = Groove Code AG = Part No. 1-276337-1

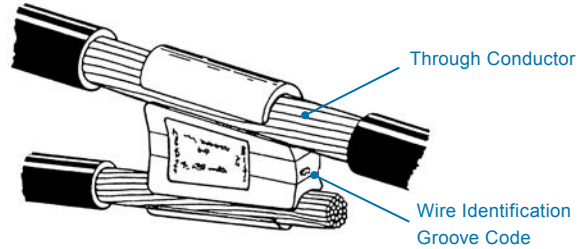

Wire Size*	Red Shells (69338-2)				White Shells (69338-5)				Blue Shells (69338-1)					Yellow (69338-4)
	X 5,6	W 4	T 2	O 1/0	N 2/0	M 3/0	L 4/0	K (R) 250	H 300	G 350	E 400	B 450	A 500	750 (61)
X 5,6	277060-4	277060-4	277060-2	277060-2	4-275187-0	3-275187-7	3-275187-4	3-275187-1	6-276337-5	5-276337-4	4-276337-2	2-276337-9	1-276337-8	1-81723-3*
W 4		277060-3	277060-2	277060-1	3-275187-9	3-275187-6	3-275187-3	3-275187-0	6-276337-4	5-276337-3	4-276337-1	2-276337-8	1-276337-7	1-81723-3*
T 2			277060-1	277060-1	1-275187-7	1-275187-4	1-275187-0	275187-5	6-276337-2	5-276337-1	3-276337-9	276337-4	276337-8	1-81723-2*
O 1/0				1-275187-8	1-275187-6	1-275187-3	275187-9	275187-4	6-276337-0	4-276337-9	3-276337-7	2-276337-5	1-276337-4	1-81723-2*
N 2/0					1-275187-5	1-275187-2	275187-8	275187-3	5-276337-9	4-276337-8	3-276337-6	276337-3	276337-7	1-81723-1*
M 3/0						1-275187-1	275187-7	275187-2	5-276337-8	4-276337-7	3-276337-5	2-276337-4	1-276337-3	1-81723-0*
L 4/0							275187-6	275187-1	5-276337-7	4-276337-6	3-276337-4	276337-2	276337-6	81723-9*
K (R) 250								2-275187-8	5-276337-6	4-276337-5	3-276337-3	2-276337-3	276337-9	81723-8*
H 300									5-276337-5	4-276337-4	3-276337-2	2-276337-2	1-276337-2	*****
G 350										4-276337-3	3-276337-1	2-276337-1	1-276337-1	*****
E 400											3-276337-0	2-276337-0	1-276337-0	*****
B 450												1-276337-9	276337-1	*****
A 500													276337-5	81723-2
750 (61)														81723-1

For additional sizes not listed, contact your TE Representative.

## AMPACT Copper Wire Taps

Catalog Numbers		Catalog Numbers	
Tap	Cartridge	Tap	Cartridge
275187-1	69338-5	1-276337-9	69338-1
275187-2	69338-5	2-276337-0	69338-1
275187-3	69338-5	2-276337-1	69338-1
275187-4	69338-5	2-276337-2	69338-1
275187-5	69338-5	2-276337-3	69338-1
275187-6	69338-5	2-276337-4	69338-1
275187-7	69338-5	2-276337-5	69338-1
275187-8	69338-5	2-276337-8	69338-1
275187-9	69338-5	2-276337-9	69338-1
1-275187-0	69338-5	3-276337-0	69338-1
1-275187-1	69338-5	3-276337-1	69338-1
1-275187-2	69338-5	3-276337-2	69338-1
1-275187-3	69338-5	3-276337-3	69338-1
1-275187-4	69338-5	3-276337-4	69338-1
1-275187-5	69338-5	3-276337-5	69338-1
1-275187-6	69338-5	3-276337-6	69338-1
1-275187-7	69338-5	3-276337-7	69338-1
1-275187-8	69338-5	3-276337-9	69338-1
2-275187-8	69338-5	4-276337-1	69338-1
3-275187-0	69338-5	4-276337-2	69338-1
3-275187-1	69338-5	4-276337-3	69338-1
3-275187-3	69338-5	4-276337-4	69338-1
3-275187-4	69338-5	4-276337-5	69338-1
3-275187-6	69338-5	4-276337-6	69338-1
3-275187-7	69338-5	4-276337-7	69338-1
3-275187-9	69338-5	4-276337-8	69338-1
4-275187-0	69338-5	4-276337-9	69338-1
276337-1	69338-1	5-276337-1	69338-1
276337-2	69338-1	5-276337-3	69338-1
276337-3	69338-1	5-276337-4	69338-1
276337-4	69338-1	5-276337-5	69338-1
276337-5	69338-1	5-276337-6	69338-1
276337-6	69338-1	5-276337-7	69338-1
276337-7	69338-1	5-276337-8	69338-1
276337-8	69338-1	5-276337-9	69338-1
276337-9	69338-1	6-276337-0	69338-1
1-276337-0	69338-1	6-276337-2	69338-1
1-276337-1	69338-1	6-276337-4	69338-1
1-276337-2	69338-1	6-276337-5	69338-1
1-276337-3	69338-1	277060-1	69338-2
1-276337-4	69338-1	277060-2	69338-2
1-276337-7	69338-1	277060-3	69338-2
1-276337-8	69338-1	277060-4	69338-2

## AMPACT Copper Taps Technical Data

AMPACT copper taps have been tested for the most severe service environment that they would normally be exposed to under both distribution and grounding applications. They have been tested to meet or exceed the requirements of ANSI C119.4-1976 (TDJ-162), NEMA CC3-1973, Class A 500 cycles. The chart shows the average DC resistance normalized to 20°C for P/N 2-275187-8 applied to 250 kcmil Cu 37 strand conductor.

AMPACT copper taps have been tested at 36,000 amps symmetrical RMS for 4 seconds or 248 cycles on 500 to 500 kcmil copper conductor per IEEE 80, IEEE guide for Safety in AC Substation Grounding. They are tested and rated for use on conductors that will be exposed to temperatures up to and including 800°C. AMPACT copper taps frequently run 500°C cooler than the conductor to which they are applied.

The AMPACT copper tap meets all mechanical requirements of ANSI C119.4 and is rated as a Class 3 minimum-tension connector.

One of the most severe requirements placed on a connector for below grade grounding applications is corrosion resistance. In order to make our corrosion testing more severe and more realistic, we first subject the electrical connections to thermal shock. Our procedure for subjecting a connector to thermal shock is as follows:

**Thermal Shock**

Specification 109-13009

Ea. cycle = 150 minutes - 150°C oven

15 minutes- ice water

30 minutes - 150°C oven

60 minutes - room temp.

(Test repeated for 5 complete cycles)

Typical results of testing after thermal shock and corrosion are shown below.

**DC Resistance—**

Milliohms measured at 60 amperes

	Initial	After Thermal Shock	After Corrosion
Min.	.087	.080	.078
Max.	.093	.089	.086
Avg.	.089	.083	.082
EWL	.100	.098	.102

EWL - Equal wire length



C\_CopperTermLug

## Copper Terminal Lug

- Easy to install with AMPACT tooling
- Use as disconnectable tap or jumper connection
- Controlled contact pressure
- Easily removable and relocated
- NEMA-type terminal

### Selection Information

Paddle Type	Shank Size Conductor	(Tap Groove)	Catalog Number
Copper 2-Hole Paddle	#2 to 500 kcmil Copper Cable	4/0 STR	276762-1



C\_Shear-Lok

## SHEAR-LOK Grounding Connector Copper Tap/Grounding Connector

SHEAR-LOK copper tap/grounding connector was developed for applications in the power utility industry where connectors are required to withstand mid-range (20 kA symmetrical RMS) magnitudes of fault current. The SHEAR-LOK connectors utilize Wedge Pressure Technology and controlled torque drive bolts to provide easily-applied and highly-reliable ground rod connections.

This family of connectors is ideal for pole grounds, transmission grounding, Telco and CATV applications where connections must be made between conductor and rods, specifically in the range of #10, #6, #4, to both 5/8" and 3/4" copper clad galvanized rods.

- Wedge Pressure Technology
- Shear-head bolt—controlled torque
- Removable without conductor damage
- No special tools
- Application not inhibited by disfigured ground rod end
- Taps into existing ground conductors

### Typical Applications

- Industrial/residential service grounds
- Pole grounds transmission line grounding
- Telco distribution, CATV grounds

### Selection Information: dimensions shown in inches (millimeters)

Connects Rod To	Conductor	Catalog Number
5/8" Cu Clad Dia .562 (14.30)	1/0 Str.	83000-1*
5/8" Cu Clad Dia .562 (14.30)	#6 Sol. or Strd. or #4 Sol. or Strd.	80408-2*†
5/8" Galv. Dia .562 (15.88)	#6 Sol. or Strd.	80408-2*†
3/4" Cu Clad Dia .682 (17.32)	#6 Sol. or Strd.	80408-3
3/4" Cu Clad Dia .682 (17.32)	#4 Sol. or Strd.	80408-4*†
3/4" Galv. Dia .750 (19.05)	#6 Sol. or Strd.	80408-4*†
3/4" Galv. Dia .750 (19.05)	#4 Sol. or Strd.	80408-5
3/4" Cu Clad Dia .682 (17.32)	1/0 Str.	80408-6*
5/8" Cu Clad Dia .562 (14.30)	#6 Sol., #8 Sol., Strd. or #10 Sol., Strd.	80408-7

\*UL Listed File No.E69905 Grounding & Bonding Including Direct Burial

†CSA Certified

### Technical Document

Instruction Sheet 408-9921



File No. E69905  
Grounding & Bonding  
Including Direct Burial.



Certified by Canadian  
Standards Association.



C\_Wrench-Lok

## WRENCH-LOK Grounding Connector Electrical Grounding System

The WRENCH-LOK electrical grounding connector system provides a superior, fool-proof connection while reducing application time dramatically. The WRENCH-LOK connector system uses a specially designed shear-head bolt to drive a tapered wedge into the connector body. All that's needed to apply it is a common ratchet or socket wrench. When the connection is tightened to the proper torque, the bolt head shears off, giving a positive visual indication of a perfect connection. It's that simple and sure. WRENCH-LOK connectors require no special training, no special tools, no auxiliary power, and they can be installed in any weather. The product line offers options to connect conductor-to-conductor or conductor-to-ground rod. There is no need to change connector styles, molds or tooling.



Listed by Underwriters Laboratories Inc., File No. E69905

REA

Meets requirements of IEEE STD 837

Certified by Canadian Standards Association, File No. LR56476

### Test Results for Copper Ground Grid Connectors

IEEE Standard 837

Overall, connectors meet all requirements necessary to be considered qualified for permanent grounding connections used in substation grounding.

A. Mechanical Pullout

Connectors exceeded min. standard pullout requirements by wide margin.

B. Electromagnetic Force

Connectors withstood high mechanical and heating stresses of short circuit currents, well within standard.

C. Sequential Tests

1. Current-Temperature Cycling

Connectors ran much cooler than control conductor and resistance remained low and stable.

2. Freeze-Thaw

Resistance of connectors remained stable, demonstrating connectors are not affected by extreme temp. changes.

3. Corrosion-Nitric Acid

Acid did not penetrate contact interface and resistance remained stable.

4. Fault Current

Connectors withstood severe mechanical and heating stresses with very slight increase in joint resistance, well within standard.

Thermal Shock and Accelerated Corrosion

Stable performance indicates connectors will not be adversely affected by extreme environmental conditions.

Torque of Bolt vs. Resistance of Connection

Connection resistance stable at point much below nominal torque.

Torque of Bolt vs. Deflection

Connector designed with sufficient strength and spring qualities to maintain body resilient contact force for dependable, long-term connection.

Tensile vs. Deflection

Connector body designed with sufficient strength to withstand extreme overload mechanical forces.

### Technical Documents

Department Publication	410-5812
Instruction Sheet	408-9504

## Wrench-Lok Copper Grounding Connector System Selection Charts

## Ground Rod-to-Conductor

3/8		1/2		5/8		3/4		Conductor
Copper Clad	Galv. Steel	Copper Clad	Galv. Steel	Copper Clad	Galv. Steel	Copper Clad	Galv. Steel	
<b>.355 (9.02)</b>	<b>.375 (9.52)</b>	<b>.475 (12.06)</b>	<b>.500 (12.70)</b>	<b>.563 (14.30)</b>	<b>.625 (15.88)</b>	<b>.682 (17.32)</b>	<b>.750 (19.05)</b>	
83747-2	83747-2	83747-4	83747-4	83749-1	83749-2	83749-3	83749-4	#2 sol, str, cmpt
83747-3	83747-3	83749-1	83749-1	83749-2	83749-3	83749-4	83748-3	1/0 str, cmpt
83747-4	83747-4	83749-2	83749-2	83749-3	83748-1	83748-3	83748-4	2/0 str, cmpt
		83749-2	83749-3	83748-1	83748-2	83748-4	83751-1	3/0 str, cmpt
		83748-1	83748-1	83748-2	83748-4	83751-1	83751-2	4/0 str, cmpt
				83750-1	83748-4	83751-1	83751-2	250 compacted
				83750-1	83751-1	83751-2	83751-3	250 str
					83751-1	83751-2	83751-3	300 compacted
					83751-2	83751-3	83751-4	300 str
					83751-2	83751-3	83751-4	350 compacted
						83751-3	83750-2	350 str
						83751-3	83751-4	400 compacted
							83750-3	500 str

## Conductor-to-Conductor (Standard Round)

#2 sol, str	1/0 str	2/0 str	3/0 str	4/0 str	250 str	300 str	350 str	400 str	450 str	500 str	Conductor
83747-1	83747-2	83747-2	83747-3	83747-4	83747-1	83749-2	83749-3	83749-4	83749-4	---	#2 sol, str
	83747-3	83747-3	83747-4	83749-1	83749-2	83749-3	83748-1	83749-3	83749-3	83751-1	1/0 str
		83747-4	83749-1	83749-2	83749-3	83748-1	83748-2	83748-3	83748-4	83751-1	2/0 str
			83749-2	83749-3	83748-1	83748-2	83748-3	83748-4	83751-1	83751-2	3/0 str
				83748-2	83748-2	83748-4	83751-1	83751-1	83751-2	83751-3	4/0 str
					83750-1	83751-1	83751-2	83751-2	83751-3	83751-4	250 str
						83750-2	83751-2	83751-3	83751-4	83750-2	300 str
							83751-3	83751-4	83750-2	83750-3	350 str
								83750-2	83750-4	83750-5	400 str
									83750-5	83750-4	450 str
										83750-6	500 str

## Conductor-to-Conductor (Compacted)

#2	1/0	2/0	3/0	4/0	250	300	350	400	450	500	Conductor
83747-1	83747-2	83747-2	83747-3	83747-4	83747-4	83749-1	83749-2	83749-3	83749-3	83749-4	#2
	83747-3	83747-3	83747-4	83749-1	83749-2	83749-2	83749-3	83749-1	83749-1	83749-3	1/0
		83747-4	83747-1	83749-2	83749-2	83749-3	83748-1	83748-2	83748-3	83748-4	2/0
			83749-2	83749-3	83748-1	83748-1	83748-2	83748-3	83748-4	83751-1	3/0
				83748-1	83748-2	83748-2	83748-4	83748-4	83751-1	83751-1	4/0
					83750-1	83750-1	83748-4	83751-1	83751-2	83751-2	250
						83750-1	83751-1	83751-1	83751-2	83751-3	300
							83751-2	83751-2	83751-3	83751-3	350
								83751-3	83751-4	83751-4	400
									83750-2	83750-2	450
										83750-3	500

## Replacement Bolts Part Numbers

Small Body	81249-4
Large Body	81249-2

Conductors listed are for Stranded Copper Standard Round

## Wrench-Lok Copper Grounding Connector System Selection Information

Catalog Number	Description		Conductor to Ground Rod
	Small Body	Standard Round	
83747-1	#2 sol., str.	#2 sol., str.	2-#2
83747-2	1/0, 2/0 str.	#2 sol., str.	1/0, 2/0-#2
83747-3	1/0, 2/0 str.	1/0 str.	1/0, 2/0-1/0
	3/0 str.	#2 sol., str.	3/0-#2
83747-4	2/0 str.	2/0 str.	2/0-2/0
	3/0 str.	1/0 str.	3/0-1/0
	4/0 str.	#2 sol., str.	4/0, 250-#2
83749-1	3/0 str.	#2 str.	3/0-2/0
	4/0 str.	1/0 str.	4/0-1/0
	250 str.	#2 sol., str.	300-#2
83749-2	3/0 str.	3/0, str.	3/0-3/0
	4/0 str.	2/0 str.	4/0, 250-2/0
	250 str.	1/0 str.	250/300-1/0
	300 str.	#2 sol., str.	350-#2
83749-3	4/0 str.	3/0 str.	4/0-3/0
	250 str.	2/0 str.	300-2/0
	300 str.	1/0 str.	350-1/0
	350 str.	#2 sol., str.	400, 450-#2
83748-1	4/0 str.	4/0 str.	4/0-4/0
	250 str.	3/0 str.	250, 300-3/0
	300 str.	2/0 str.	350-2/0
	350 str.	1/0 str.	400-1/0
83748-2	4/0 str.	4/0 str.	250, 300-4/0
	300 str.	3/0 str.	350-3/0
	350 str.	2/0 str.	400-2/0
83749-4	400, 450 str.	#2 sol., str.	450-1/0
			500-#2
83748-3	350 str.	3/0 str.	400-3/0
	400 str.	2/0, 1/0 str.	450-2/0
	450 str.	1/0 str.	500-1/0
83748-4	300 str.	4/0 str.	350-4/0, 250
	400 str.	3/0 str.	400-4/0
	450 str.	2/0 str.	450-3/0
			500 - 2/0
83750-1	250 str.	250 str.	250, 300-250, 300
83751-1	300 str.	250 str.	350, 400-300
	350, 400 str.	4/0 str.	400-250
	450 str.	3/0 str.	450-4/0
	500 str.	2/0 str.	500-3/0
83751-2	300, 350 str.	300 str.	350, 400-350
	350, 400 str.	250 str.	450-300, 250
	450 str.	4/0 str.	500-250
	500 str.	3/0 str.	
83751-3	350 str.	350 str.	400-400
	400 str.	300 str.	450-350
	450 str.	250 str.	500-350, 300
	500 str.	4/0 str.	
83751-4	400 str.	350 str.	400, 500-400
	450 str.	300 str.	
	500 str.	250 str.	
83750-2	400 str.	400 str.	450, 500-450
	450 str.	350 str.	
	500 str.	300 str.	
83750-3	450 str.	400 str.	500-500
	450 str.	400 str.	
	500 str.	350 str.	
83750-5	450 str.	450 str.	
	500 str.	400 str.	
83750-4	500 str.	450 str.	
83750-6	500 str.	500 str.	



## Wrench-Lok Copper Grounding Connector System Wire Diameter Limits

IMPERIAL						
	Sum of Diameters		Large Wire		Small Wire	
	Max.	Min.	Max.	Min.	Max.	Min.
83747-1	0.595	0.500	0.296	0.204	0.296	0.204
83747-2	0.706	0.594	0.420	0.298	0.296	0.204
83747-3	0.782	0.672	0.470	0.302	0.370	0.258
83747-4	0.832	0.733	0.520	0.313	0.420	0.258
83749-1	0.890	0.799	0.630	0.423	0.470	0.258
83749-2	0.942	0.846	0.630	0.423	0.470	0.258
83749-3	1.003	0.898	0.700	0.470	0.470	0.258
83748-1	1.050	0.943	0.700	0.470	0.700	0.292
83748-2	1.099	0.995	0.700	0.470	0.522	0.295
83749-4	1.068	0.964	0.770	0.500	0.470	0.258
83748-3	1.146	1.042	0.770	0.500	0.520	0.292
83748-4	1.192	1.086	0.770	0.500	0.520	0.316
83750-1	1.148	1.040	0.580	0.460	0.580	0.460
83751-1	1.250	1.147	0.815	0.572	0.575	0.336
83751-2	1.311	1.212	0.815	0.582	0.630	0.414
83751-3	1.374	1.288	0.815	0.606	0.682	0.473
83751-4	1.419	1.342	0.815	0.660	0.682	0.527
83750-2	1.464	1.400	0.815	0.670	0.730	0.585
83750-3	1.510	1.446	0.815	0.676	0.770	0.631
83750-5	1.546	1.495	0.815	0.680	0.815	0.680
83750-4	1.580	1.538	0.815	0.723	0.815	0.723
83750-6	1.620	1.578	0.815	0.763	0.815	0.763

METRIC						
	Sum of Diameters		Large Wire		Small Wire	
	Max.	Min.	Max.	Min.	Max.	Min.
83747-1	15.113	12.700	7.518	5.182	7.518	5.182
83747-2	17.932	15.088	10.668	7.569	7.518	5.182
83747-3	19.863	17.069	11.938	7.671	9.398	6.553
83747-4	21.133	18.618	13.208	7.950	10.668	6.553
83749-1	22.606	20.295	16.002	10.744	11.938	6.553
83749-2	23.927	21.488	16.002	10.744	11.938	6.553
83749-3	25.476	22.809	17.780	11.938	11.938	6.553
83748-1	26.670	23.952	17.780	11.938	17.780	7.417
83748-2	27.910	25.273	17.780	11.938	13.259	7.493
83749-4	27.127	24.486	19.558	12.700	11.938	6.553
83748-3	29.108	26.467	19.558	12.700	13.208	7.417
83748-4	30.277	27.584	19.558	12.700	13.208	8.026
83750-1	29.159	26.416	14.732	11.684	14.732	11.684
83751-1	31.750	29.134	20.701	14.529	14.605	8.534
83751-2	33.299	30.785	20.701	14.783	16.002	10.516
83751-3	34.900	32.715	20.701	15.390	17.323	12.014
83751-4	36.043	34.087	20.701	16.764	17.323	13.386
83750-2	37.186	35.560	20.701	17.018	18.542	14.859
83750-3	38.354	36.728	20.701	17.170	19.558	16.027
83750-5	39.268	37.973	20.701	17.272	20.701	17.272
83750-4	40.132	39.065	20.701	18.364	20.701	18.364
83750-6	41.148	40.081	20.701	19.380	20.701	19.380

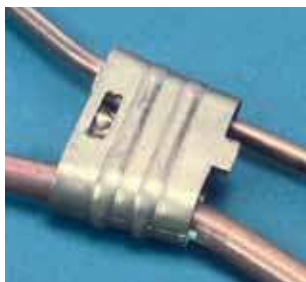

C\_UDC

## Universal Distribution Connectors

Universal Distribution Connectors are composed of a “C” component and a “Wedge” component, both made of a tin-plated copper alloy, in a configuration that creates a spring action.

They are recommended for connecting conductors of aluminum, copper, steel and their alloys regardless of the combination (i.e., Al to Al, Al to Cu, Cu to Cu) in normal corrosive environments. Their technical design and construction are such that they have neither the disadvantages of some screw connectors, which must be periodically readjusted and retightened, nor the drawbacks of compression-type connectors, which are difficult to select and install, and which, once applied, cannot be removed without rendering the conductors useless. In addition to these technical features, the Universal Distribution Connector provides a noncorrosive connection that is protected against temperature variation and overloading.

The Universal Distribution Connector can be rapidly and safely installed without special tools. Conventional “parallel jaw” pliers are used to make the connection. A good connection can be easily verified by visual inspection. A wide range of connectors cover combinations of conductors ranging from 14 AWG to 4/0 AWG [1.5 mm<sup>2</sup> to 120 mm<sup>2</sup>], and all can be removed without damaging the conductors.

The reinforced version was developed to comply to ANSI C119.4 “Pull-Out” test and can be used in high cable tension applications. Both connector versions comply with all other specifications/ tests of ANSI C119.4 Standard.

### Technical Documents

Product Specifications	108-37019
Instruction Sheet	411-37014

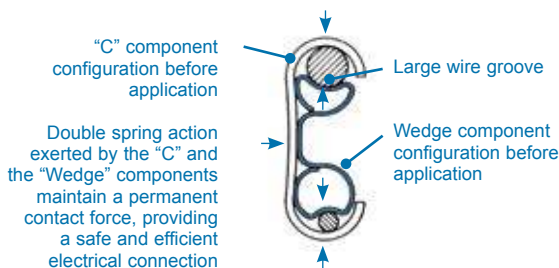

### Residential/Commercial Grounding

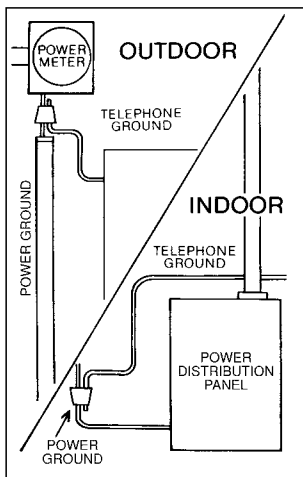

- Telephone grounding
- Street lights
- Service entrance drops
- Aerial connections

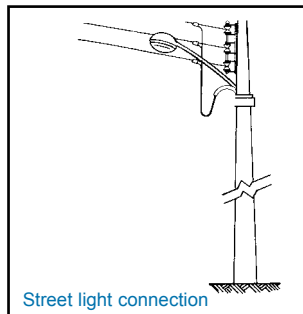
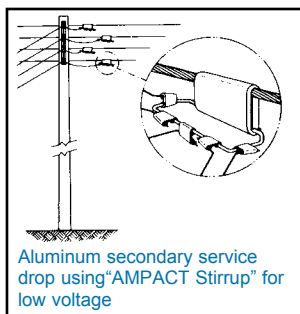
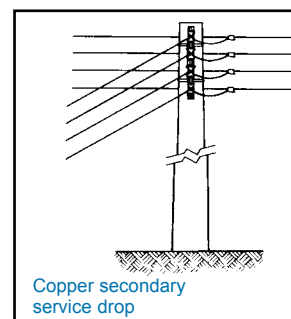
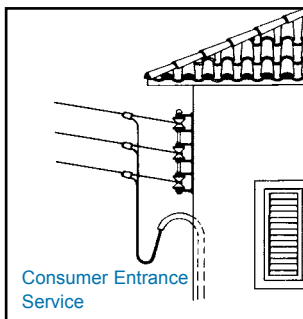
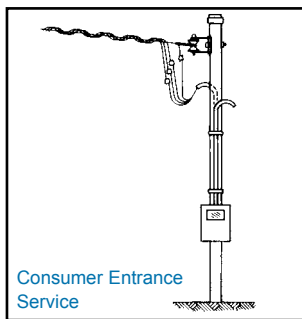

	Type	Top Groove		Bottom Groove		Sum		Package Color	Catalog No. (Reinforced)	Cover Catalog No.
		max.	min.	max.	min.	max.	min.			
Symmetrical Connectors	I	.320 (8,12)	.125 (3,17)	.275 (7,00)	.125 (3,17)	.551 (14,01)	.418 (10,60)	Gray	881781-1	881224-1
	II	.320 (8,12)	.125 (3,17)	.208 (5,30)	.125 (3,17)	.417 (10,59)	.347 (8,82)	Green	881783-1	881225-1
	III	.258 (6,55)	.100 (2,54)	.174 (4,41)	.050 (1,27)	.346 (8,81)	.291 (7,40)	Red	881785-1	881226-1
	IV	.241 (6,12)	.100 (2,54)	.145 (3,70)	.050 (1,27)	.290 (7,39)	.236 (5,99)	Blue	881787-1	881226-1
	V	.186 (4,72)	.100 (2,54)	.118 (3,00)	.050 (1,27)	.235 (5,98)	.180 (4,58)	Yellow	881789-1	881226-1
	VI	.417 (10,61)	.315 (8,01)	.368 (9,36)	.257 (6,54)	.737 (18,72)	.661 (16,79)	White/ Blue	444031-1	602061-0
	VII	.398 (10,11)	.183 (4,66)	.327 (8,30)	.183 (4,66)	.660 (16,78)	.552 (14,02)	White/ Red	444033-1	602061-0
	VIII	.398 (10,11)	.315 (8,01)	.398 (10,11)	.315 (8,01)	.796 (20,22)	.738 (18,73)	Green/ White	444385-1	602061-0
Asymmetrical Connectors	A	.368 (9,36)	.220 (5,60)	.201 (5,10)	.068 (1,74)	.431 (10,95)	.358 (9,10)	Violet	688652-1	688385-1
	B	.368 (9,36)	.244 (6,20)	.201 (5,10)	.068 (1,74)	.516 (13,11)	.431 (10,95)	Orange	688653-1	688385-1
	C	.501 (12,74)	.323 (8,20)	.201 (5,10)	.068 (1,74)	.581 (14,75)	.516 (13,11)	Brown	688654-1	688386-1
	D	.501 (12,74)	.374 (9,50)	.201 (5,10)	.068 (1,74)	.669 (17,00)	.581 (14,75)	White	688655-1	688386-1
	F	.328 (8,33)	.220 (5,60)	.201 (5,10)	.068 (1,74)	.358 (9,10)	.283 (7,20)	Green/ Blue	688656-1	688385-1
	G	.328 (8,33)	.220 (5,60)	.068 (1,73)	.054 (1,36)	.358 (9,10)	.283 (7,20)	Violet/ Blue	688657-1	688385-1

\*Note: Universal Distribution Connectors are supplied in individual packages identified by Type.

**Example**

To make a service entrance of a 4 AWG [21 mm<sup>2</sup>] stranded Al cable to a 10 AWG [5.12 mm<sup>2</sup>] solid Cu wire, add:

- Diameter of Main Wire (4 AWG [21 mm<sup>2</sup>] stranded Al cable)
- Diameter of Service Entrance Wire (10 AWG [5.12 mm<sup>2</sup>] solid Cu wire)
- Total of Diameters

= 0.232 in. [5,89 mm]	} The recommended connector is Type III, with the red color plastic bag.
= 0.096 in. [2,44 mm]	
= 0.328 in. [8,33 mm]	

**Extraction Tools**

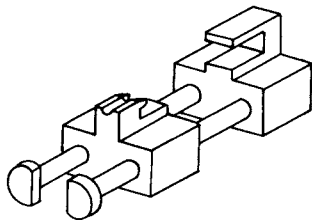

**572882-1**  
IS 411-37014

(For use with Symmetrical Connectors)

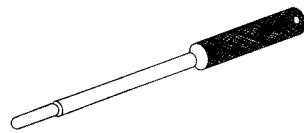

**357486-1**  
IS 411-37014

(For use with Asymmetrical Connectors)

Selection Information: Symmetrical and Asymmetrical Connectors (AWGx AWG)

Wire Size	SOLID						STR CU/AL AAC							STR ACSR						STR COMPRESSED										
	10	8	6	4	2	1/0	10	8	6	4	2	1/0	2/0	3/0	4/0	8	6	4	2	1/0	2/0	3/0	4/0	8	6	4	2	1/0		
<b>SOLID</b>	14	V	V	IV	III/G	A	V	V	IV	III/G	G	K	K		V	IV	III/G	H	K					V	IV	IV/G	G	H		
	12	V	V	IV	III/F	A	V	V	IV	III/F	A	B	J	C		IV	IV	III/F	A	J	C	D		V	IV	IV	A	B		
	10	V	V	V	III	II/F	A	V	IV	IV	III/F	A	B	C	C	IV	III	F	A	J	C	D	L	IV	IV	III	A	B		
	8		IV	IV	III	II/A	B		IV	III	II/A	B	B	C	F	L	IV	III	II/A	I/B	C	C	D	L	IV	III	III	II/A	B	
	6			III	II	I/A	B			III	II/A	I/B	C	C	D			II	II/A	I/B	C	D	D	L		III	II	I/B	C	
	4				II	I					I	I	VII						I	I	VII							I	VII	
	2						VII						I	VII	VI					VII	VII	VI							I	VII
1/0						VII						VI							VI										VI	
<b>STR CU/AL AAC</b>	14		V	IV	IV	III/F	A	V	V	IV	III/F	A	B	J	C		V	IV	III/F	A	J	C	C		V	IV	IV/F	A	B	
	12		V	V	IV	III	F	A	V	IV	IV	III/F	A	B	J	C		IV	IV	III/F	A	J	C	D	L	V	IV	III	A	B
	10		V	IV	IV	III	A	B	V	IV	III	F	A	B	C	D		IV	III	A	B	J	C	D	L	IV	III	III	A	B
	8			IV	III	II	II/A	B		III	III	II/A	I/B	B	C	D	L	III	III	II/A	I/B	VII/C	D	D	L	IV	III	II	I/A	B
	6				II	I/B	B			III	II/A	I/B	VII/C	D	D			II	I/B	I/B	VII/D	D	D	L			II	I/B	C	
	4						VII					I	I	VII						I	I	VI							I	VII
	2						VII					VII	VII	VI						VII	VIII									VII
1/0											VI																			VI
<b>STR ACSR</b>	8		IV	III	II	II/A	B		III	III	II/A	I/B	C	C	D	L	III	II	II/A	I/B	C	D	D	L			III	II	I/B	CA
	6				II	I/B	C			II	I/A	I/B	VII/C	D	D			II	I/B	I/B	VII/D	D		L			II	I/B	VII/C	
	4						VII					I	VII	VII					I	VII	VII								I	VII
	2						VII					VI	VI							VII	VI									VI
	1/0											VI	VI							VIII										VIII
	14						F	A				F	A	B	J					F	A	J						F	F	B
	12						F	A				F	A	B	J	C				F	A	J	C	D	L			F	A	B
10						A	B				F	A	B	C	D				A	B	J	C	D	L			F	A	B	
8			IV	III	III	II/A	B		IV	III	II/A	I/B	C	C	D	L	III	III	II/A	I/B	C	D	D	L	IV	III		I/A	B	
6				III	II	I/B	B			II	II/A	I/B	C	D	D	L		II	I/A	I/B	C	D	L	L		II	II/A	I/B	C	
4					II	I					I	I	VII						I	I	VII						II	II	I	VII
2						VII					VII	VII	VI							VII	VI							VII	VII	
1/0						VI					VI									VII										VI

Selection Information: Symmetrical and Asymmetrical Connectors (AWGx mm²)

Wire Size	SOLID						STR CU/AL AAC							STR ACSR						STR COMPRESSED											
	10	8	6	4	2	1/0	10	8	6	4	2	1/0	2/0	3/0	8	6	4	2	1/0	2/0	3/0	8	6	4	2	1/0					
<b>SOLID</b>	1.5	V	V	IV	III/G	A	V	V	IV	IV/G	G	H	K		V	IV	III/G	H	K	H				V	V	IV	G	H			
	2.5	V	V	IV	III/F	A	V	V	IV	III/F	A	B	J	C		V	IV	III/F	A	J	A	C		V	IV	III/F	F	A			
	4	V	V	IV	III/F	A	IV	V	IV	III/F	A	B	J	C		IV	IV	III/F	A	J	A	D		V	IV	III/F	A	B			
	6		V	IV	III	A	A/B	IV	IV	IV	III/F	A	B	C	C	IV	III	F	A	J	A	D		IV	IV	III/F	A	B			
	10			III	III	IV/A	B	III	IV	III	II/A	I/A	B	C	D	III	III	IV/A	I/B	C	I	D		IV	III	A/II	I/A	B			
	16				II	I/A/B	B			II	II/A	I/B	C	D	D		II	I/A	I/B	C	I/B	D			II	A/II	I/B	C			
	25					I					I	I	VII						I	I	VII	I	L				I	I	VII		
35					H	VII					VII	VII	VI						VII	VI	VII						I	VII			
50						VII					VI	VI							VII	VI	VII								VI		
<b>STR CU/AL AAC</b>	1.5		V	IV	III/G	H	V	V	V	IV/G	G	H	K		V	IV	III/G	H	K					V	IV	IV/G	G	H			
	2.5		V	V	IV	III/F	A	V	V	V	III/F	A	B	J	C		IV	IV	III/F	A	J	C	C		V	IV	III/F	A	B		
	4		V	V	III	F	A	IV	IV	V	III/F	A	B	J	C		IV	III	F	A	J	C	D		IV	IV	III/F	A	B		
	6			IV	IV	III	A	B	IV	IV	IV	F	A	B	C	D		IV	III	A	B	C	C	D		IV	III	F	A	B	
	10				III	II	II/A	B	III		III	II/A	I/B	C	C	D			II	II/A	I/B	C	D	D			III	II/A	B	C	
	16					II	I					I	I	VII						I	I	VII							I	I/B	VII
	25						VII					I	VII								VII	VII							I	VII	
35						VII					VI	VI								VII	VI							I	VII		
50											VI										VIII									VI	

Selection Information: Symmetrical and Asymmetrical Connectors (mm<sup>2</sup> x AWG)

	Wire Size	SOLID					STR AAC							STR COMPRESSED									
		6	10	16	25	35	50	4	6	10	16	25	35	50	70	90	10	16	25	35	50	70	95
<b>SOLID</b>	14	V	V	IV	III/G	G	H	V	V	IV	III/G	H	H	K	V	IV	III/G	G	H	K			
	12	V	V	IV	III/F	F	A	V	V	IV	III/F	A	B	J	C	V	IV	III/F	F	A	J	C	
	10	V	IV	IV	III/F	A	A	V	V	V	III	F	A	B	J	D	IV	IV	III/F	A	A	J	C
	8		IV	III	II/F	II/A	I/B			IV	III	II/A	I/A	B	C	D	IV	III	II/A	II/A	I/B	J	C
	6			III	II/A	I/A	IB				II	II/A	I/B	C	C	D		II	II/A	I/B	I	C	D
	4				I	I	I					I	I	VII					I	I	I	VII	
	2					I	VII						VII	VII	VI					I	VII	VII	
1/0													VI	VI								VI	
<b>STR</b>	14	V	V	IV	III/F	F	A	V	V	IV	III/F	A	B	J	C	V	IV	III/F	F	A	J	C	
	12	V	V	IV	III/F	F	A	V	V	IV	III	III/F	A	B	J	C	IV	IV	III/F	A	A	J	C
	10		IV	IV	III/F	A	A/B		IV	IV	III	A	A	B	C	D	IV	III	F	A	B	J	C
	8			III	II/A	II/A	I/B			III	II	II/A	I/B	B	C	D	III	III	II/A	I/A	I/B	C	D
	6				II/A	I/B	I/B				II	I/B	I/B	C	D	D		II	I/A	I/B	I/B	VII/C	D
	4					I	I					I	I	VII					I	I	I	VII	
	2						VII						VII	VII							VII	VI	
1/0																					VIII		

Selection Information: Symmetrical and Asymmetrical Connectors (mm<sup>2</sup> x mm<sup>2</sup>)

	Wire Size	SOLID					STR AAC							STR COMPRESSED									
		6	10	16	25	35	50	6	10	16	25	35	50	70	95	10	16	25	35	50	70	95	
<b>SOLID</b>	1.5	V	V	IV	G	H	V	V	IV	III/G	G	H	K	V	IV	III/G	G	H	K				
	2.5	V	IV	IV/F	F	A	V	V	IV	III/F	A	A	J	C	V	IV	III/A	F	A	J			
	4	V	V	IV	III/F	F	A	V	IV	IV	III/F	A	B	J	C	V	IV	III/F	A	A	J	C	
	6	V	IV	IV	III/F	A	A	V	IV	III	F	A	B	J	D	IV	III	III/F	A	A	J	C	
	10		IV	III	II/A	II/A	I/B			III	III	II/A	I/B	B	C	D	IV	III	II/A	II/A	I/B	C	D
	16			I	II/A	I/B	I/B				II	I/A	I/B	C	D	D	II	II/A	I/B	I/B	C	D	
	25				I	I	I					I	I	VII				I	I	I	VII		
35					I	VII						VII	VII	IV					I	VII	VII		
50						VII						VI	VI							VII	VI		
<b>STR</b>	1.5	V	V	IV	G	H	V	V	IV	III/G	G	H	K	V	IV	III/G	G	H	K				
	2.5	V	V	IV	III/F	F	A	V	IV	IV	III/F	A	B	J	C	V	IV	III/F	F	A	J	C	
	4	V	IV	IV	III/F	A	A	V	IV	III	F	A	B	J	D	IV	IV	III/F	A	A	J	C	
	6		IV	III	III/F	A	B		IV	IV	III	A	A	B	C	D	IV	III	F	A	B	J	C
	10			III	II/A	I/A	I/B			III	II	II/A	I/B	B	C	D		III	II/A	I/B	I/B	C	D
	16				I	I	I				II	I	I	VII					I	I	I	VII	
	25					I	VII					I	I	VII						I	VII	VII	
35						VII						VII	VII	VI						VII	VI		
50												VI	VI								VI		
<b>STR COMPRESSED</b>	10			III	II/A	II/A	I/B		III	II	II/A	I/B	B	C	D	III	III	II/A	I/A	I/B	C	D	
	16				II/A	I/B	I/B			II	I/B	I/B	C	D		III	II	I/A	I/B	I/B	VII/C	D	
	25					I	I				I	I	VII					I	I	I	VII		
	35						VII					VII	VII	VI						I	VII	VII	
	50											VI	VI								VII	VI	
70																					VII		

## AMPACT Tap Selection Guide

### What are AMPACT taps?

AMPACT taps consist of a wedge and tapered, spring “C” member. AMP Inhibitor, an oxide-inhibiting compound, is placed in the tap grooves at the factory. During installation, the wedge is driven into the C member at high velocity between the run and tap conductors. This spreads the C member and places a high retentive force on the conductors for a reliable, long-lived connection. A locking tab, formed by a lance on the tool, prevents the wedge from loosening once it has been driven into position, and also provides a positive visual means for inspection.

### Importance of color codes

Color coding plays a vital role in the AMPACT tap system. When installing taps, always use color-coded shells to match each AMPACT tap.

For example: RED-coded taps require RED shell No. 69338-2  
 WHITE-coded taps require WHITE shell No. 69338-5.  
 BLUE-coded taps require BLUE shell No. 69338-1.  
 YELLOW-coded taps require YELLOW shell No. 69338-4.

**WARNING: Carefully read AMP Customer Manual CM2106, packaged with the tool, before attempting to apply any taps.**

### Approvals

Both AMPACT tools (Small Tool No. 69437 and Large Tool No. 69611) have been tested and listed by Underwriters Laboratories, Inc. (UL) and have been certified by the Canadian Standard Association (CSA). AMPACT taps that are UL Listed or CSA Certified are noted on the following pages. Note, that AMPACT taps also meet or exceed NEMA-ANSI\* specifications. AMPACT connectors and tooling also have the approval of the Rural Electrification Administration (REA).

\* National Electrical Manufacturers' Association - American National Standards Institute.

Code Letter or Number on label and wedge indicates the larger groove in each wedge

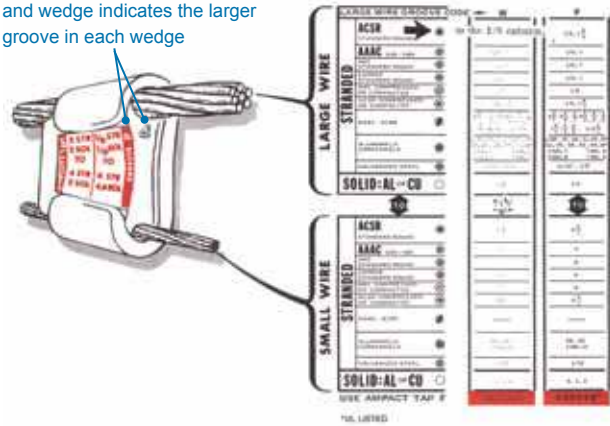

### How to use the selection charts

Note that the example chart has the larger conductor listed in the upper half of each vertical column and the smaller one in the bottom half of the column. Any wire in the upper portion of a column can be connected to any wire in the lower half of that same column by using the recommended AMPACT tap listed at the bottom of that column.

### To Use the Chart:

Carefully check the size and type of the two wires to be connected.

Example No. 1/0 stranded ACSR, standard round to No. 4 solid copper (Cu).

In the upper portion of the chart, locate ACSR standard round. From this point, move across the vertical columns (as indicated by the arrow) until you come to the 1/0 column.

In the lower half of this 1/0 column, you will find “No. 4,5,6 solid: Al or Cu.” The proper AMPACT tap number and color will appear at the bottom of this column. “USE AMPACT TAP No. 600528, COLOR RED.”











### AMPACT Aluminum Taps (Red, Blue, and Yellow Coded)

All AMPACT taps in this section are made from aluminum alloys that are corrosion resistant and highly conductive. They are used primarily to connect solid or stranded conductors including AAC, AAAC, ACSR, ACAR, AW, and ASCR/AW. They can also be used in non-corrosive environments to connect to copper conductors. In short, all aluminum taps listed in this section are used for connecting the following conductor combinations:











- Aluminum to Aluminum
- Aluminum to Copper
- Copper to Copper (in non-corrosive environments)

Individual tap packages are imprinted with applicable conductor combinations. Packages and labels are color-coded for ease in matching taps with proper tool and cartridge combinations.

## Aluminum Tap

Large Wire Groove Code		U	R	Y	S	P	U
ACSR Standard Round		8 <sup>6</sup> / <sub>1</sub>	6 <sup>6</sup> / <sub>1</sub>	4 <sup>6</sup> / <sub>1</sub> , 7 <sup>1</sup> / <sub>1</sub> , 5 <sup>6</sup> / <sub>1</sub>	2 <sup>6</sup> / <sub>1</sub> , 7 <sup>1</sup> / <sub>1</sub> , 3 <sup>6</sup> / <sub>1</sub>	1/0, 1 <sup>6</sup> / <sub>1</sub>	8 <sup>6</sup> / <sub>1</sub>
AAAC 6201 - 5003		—	6	4, 5	2, 3	1/0, 1	—
AAC Standard Round		8	6	4, 5	2, 3	1/0, 1	8
COPPER Standard Round		8	6	4, 5	2, 3	1/0, 1	8
AAC Compressed or Compacted		8	6	3, 4	1, 2	1/0	8
ACSR Compressed or Compacted		—	6 <sup>6</sup> / <sub>1</sub>	4 <sup>6</sup> / <sub>1</sub> , 7 <sup>1</sup> / <sub>1</sub>	2 <sup>6</sup> / <sub>1</sub> , 7 <sup>1</sup> / <sub>1</sub>	1/0, 1 <sup>6</sup> / <sub>1</sub>	—
AWAC, ACAR		—	—	4 <sup>6</sup> / <sub>1</sub>	4 <sup>5</sup> / <sub>2</sub> , 4 <sup>3</sup> / <sub>3</sub> , 3 <sup>3</sup> / <sub>4</sub> , 3 <sup>6</sup> / <sub>1</sub> , 5 <sup>5</sup> / <sub>2</sub> , 4 <sup>4</sup> / <sub>3</sub> , 2 <sup>6</sup> / <sub>1</sub>	4 <sup>2</sup> / <sub>5</sub> , 3 <sup>3</sup> / <sub>4</sub> , 2 <sup>2</sup> / <sub>5</sub> , 2 <sup>5</sup> / <sub>2</sub> , 4 <sup>4</sup> / <sub>3</sub> , 3 <sup>3</sup> / <sub>4</sub> , 1 <sup>6</sup> / <sub>1</sub> , 5 <sup>5</sup> / <sub>2</sub> , 4 <sup>4</sup> / <sub>3</sub> , 1/0 <sup>6</sup> / <sub>1</sub>	—
ALUMOWELD COPPERWELD		—	8A, 8C 3 No. 12	6A, 6C, 7A, 7D, 8D 3 No. 9, 3 No. 10 7 No. 12	2F, 4A, 5A, 5D, 6D, 3 No. 7, 7 No. 10, 3 No. 8, 7 No. 11	1/0F, 1F, 1G, 1J, 2A, 2G, 2J, 2K, 3A, 4D, 4N, 4P, 3 No. 5, 7 No. 8, 3 No. 6, 7 No. 9	—
Galvanized Steel		5/32"	3/16"	7/32", 1/4"	9/32", 5/16"	11/32", 3/8"	5/32"
Solid: AL or CU		8	5, 6	3, 4	1, 2	1/0	6, 8



ACSR Standard Round		—	—	—	—	—	8 <sup>6</sup> / <sub>1</sub>
AAAC 6201 - 5003		—	—	—	—	—	—
AAC Standard Round		10, 12, 14	10, 12, 14	10, 12, 14	10, 12, 14	10, 12, 14	8
COPPER Standard Round		10, 12, 14	10, 12, 14	10, 12, 14	10, 12, 14	10, 12, 14	8
AAC Compressed or Compacted		—	—	—	—	—	8
ACSR Compressed or Compacted		—	—	—	—	—	—
AWAC, ACAR		—	—	—	—	—	—
ALUMOWELD COPPERWELD		—	—	—	—	—	—
Galvanized Steel		—	—	—	—	—	5/32"
Solid: AL or CU		10, 12, 14	10, 12, 14	10, 12, 14	10, 12, 14	10, 12, 14	6, 8

Use TAP Number

602302-4

602302-3

602302-2

602302-1











602302

600532\*











Red coded taps are not sold in North America and should be substituted with white coded taps shown on the following pages.

\*UL Listed

## Aluminum Tap

Large Wire Groove Code	X	R	X	R	S	Y
ACSR Standard Round 	6 <sup>6</sup> / <sub>1</sub>	6 <sup>6</sup> / <sub>1</sub>	4 <sup>6</sup> / <sub>1</sub> , 7 <sup>1</sup> / <sub>1</sub> , 5 <sup>6</sup> / <sub>1</sub>	4 <sup>6</sup> / <sub>1</sub> , 7 <sup>1</sup> / <sub>1</sub> , 5 <sup>6</sup> / <sub>1</sub>	4 <sup>6</sup> / <sub>1</sub> , 7 <sup>1</sup> / <sub>1</sub> , 5 <sup>6</sup> / <sub>1</sub>	2 <sup>6</sup> / <sub>1</sub> , 7 <sup>1</sup> / <sub>1</sub> , 3 <sup>6</sup> / <sub>1</sub>
AAAC 6201 - 5003 	6	6	4, 5	4, 5	4, 5	2, 3
AAC Standard Round 	6	6	4, 5	4, 5	4, 5	2, 3
COPPER Standard Round 	6	6	4, 5	4, 5	4, 5	2, 3
AAC Compressed or Compacted 	6	6	3, 4	3, 4	3, 4	1, 2
ACSR Compressed or Compacted 	6 <sup>6</sup> / <sub>1</sub>	6 <sup>6</sup> / <sub>1</sub>	4 <sup>6</sup> / <sub>1</sub> , 7 <sup>1</sup> / <sub>1</sub>	4 <sup>6</sup> / <sub>1</sub> , 7 <sup>1</sup> / <sub>1</sub>	4 <sup>6</sup> / <sub>1</sub> , 7 <sup>1</sup> / <sub>1</sub>	2 <sup>6</sup> / <sub>1</sub> , 7 <sup>1</sup> / <sub>1</sub>
AWAC, ACAR 	—	—	4 <sup>6</sup> / <sub>1</sub>	4 <sup>6</sup> / <sub>1</sub>	4 <sup>6</sup> / <sub>1</sub>	4 <sup>5</sup> / <sub>2</sub> , 4 <sup>4</sup> / <sub>3</sub> , 3 <sup>3</sup> / <sub>4</sub> , 3 <sup>6</sup> / <sub>1</sub> , 5 <sup>5</sup> / <sub>2</sub> , 4 <sup>4</sup> / <sub>3</sub> , 2 <sup>6</sup> / <sub>1</sub>
ALUMOWELD COPPERWELD 	8A, 8C 3 No. 12	8A, 8C 3 No. 12	6A, 6C, 7A, 7D, 8D, 3 No. 9, 3 No. 10, 7 No. 12	6A, 6C, 7A, 7D, 8D, 3 No. 9, 7 No. 12, 3 No. 10	6A, 6C, 7A, 7D, 8D, 3 No. 9, 7 No. 12, 3 No. 10	2F, 4A, 5A, 5D, 6D, 3 No. 7, 7 No. 10, 3 No. 8, 7 No. 11
Galvanized Steel 	3 <sup>16</sup> / <sub>16</sub> "	3 <sup>16</sup> / <sub>16</sub> "	7 <sup>32</sup> / <sub>32</sub> ", 1 <sup>4</sup> / <sub>4</sub> "	7 <sup>32</sup> / <sub>32</sub> ", 1 <sup>4</sup> / <sub>4</sub> "	7 <sup>32</sup> / <sub>32</sub> ", 1 <sup>4</sup> / <sub>4</sub> "	9 <sup>32</sup> / <sub>32</sub> ", 5 <sup>16</sup> / <sub>16</sub> "
Solid: AL or CU 	4, 5	4, 5	2, 3	2, 3	2, 3	1



ACSR Standard Round 	8 <sup>6</sup> / <sub>1</sub>	6 <sup>6</sup> / <sub>1</sub>	8 <sup>6</sup> / <sub>1</sub>	6 <sup>6</sup> / <sub>1</sub>	4 <sup>6</sup> / <sub>1</sub> , 7 <sup>1</sup> / <sub>1</sub> , 5 <sup>6</sup> / <sub>1</sub>	8 <sup>6</sup> / <sub>1</sub>
AAAC 6201 - 5003 	—	6	—	6	4, 5	—
AAC Standard Round 	8	6	8	6	4, 5	8
COPPER Standard Round 	8	6	8	6	4, 5	8
AAC Compressed or Compacted 	8	6	8	6	3, 4	8
ACSR Compressed or Compacted 	—	6 <sup>6</sup> / <sub>1</sub>	—	6 <sup>6</sup> / <sub>1</sub>	4 <sup>6</sup> / <sub>1</sub> , 7 <sup>1</sup> / <sub>1</sub>	—
AWAC, ACAR 	—	—	—	—	4 <sup>6</sup> / <sub>1</sub>	—
ALUMOWELD COPPERWELD 	—	8A, 8C 3 No. 12	—	8A, 8C, 3 No. 12	6A, 6C, 7A, 7D, 8D, 3 No. 9, 3 No. 10, 7 No. 12	—
Galvanized Steel 	5 <sup>32</sup> / <sub>32</sub> "	3 <sup>16</sup> / <sub>16</sub> "	5 <sup>32</sup> / <sub>32</sub> "	3 <sup>16</sup> / <sub>16</sub> "	7 <sup>32</sup> / <sub>32</sub> ", 1 <sup>4</sup> / <sub>4</sub> "	5 <sup>32</sup> / <sub>32</sub> "
Solid: AL or CU 	8	4, 5, 6	8	5, 6	3, 4	6, 8











Use TAP Number	600535*	600535*	600535*	600530*	600531*	600534*
----------------	---------	---------	---------	---------	---------	---------

Red coded taps are not sold in North America and should be substituted with white coded taps shown on the following pages.











\*UL Listed



## Aluminum Tap

Large Wire Groove Code		S	P	Q	W
ACSR Standard Round		2 <sup>6</sup> / <sub>1</sub> , 7/ <sub>1</sub> , 3 <sup>6</sup> / <sub>1</sub>	2 <sup>6</sup> / <sub>1</sub> , 7/ <sub>1</sub> , 3 <sup>6</sup> / <sub>1</sub>	2 <sup>6</sup> / <sub>1</sub> , 7/ <sub>1</sub> , 3 <sup>6</sup> / <sub>1</sub>	1/0, 1 <sup>6</sup> / <sub>1</sub>
AAAC 6201 - 5003		2, 3	2, 3	2, 3	1/0, 1
AAC Standard Round		2, 3	2, 3	2, 3	1/0, 1
COPPER Standard Round		2, 3	2, 3	2, 3	1/0, 1
AAC Compressed or Compacted		1, 2	1, 2	1, 2	1/0
ACSR Compressed or Compacted		2 <sup>6</sup> / <sub>1</sub> , 7/ <sub>1</sub>	2 <sup>6</sup> / <sub>1</sub> , 7/ <sub>1</sub>	2 <sup>6</sup> / <sub>1</sub> , 7/ <sub>1</sub>	1/0, 1 <sup>6</sup> / <sub>1</sub>
AWAC, ACAR		4 <sup>5</sup> / <sub>2</sub> , 4/ <sub>3</sub> , 3/ <sub>4</sub> , 3 <sup>6</sup> / <sub>1</sub> , 5/ <sub>2</sub> , 4/ <sub>3</sub> , 2 <sup>6</sup> / <sub>1</sub>	4 <sup>5</sup> / <sub>2</sub> , 4/ <sub>3</sub> , 3/ <sub>4</sub> , 3 <sup>6</sup> / <sub>1</sub> , 5/ <sub>2</sub> , 4/ <sub>3</sub> , 2 <sup>6</sup> / <sub>1</sub>	4 <sup>5</sup> / <sub>2</sub> , 4/ <sub>3</sub> , 3/ <sub>4</sub> , 3 <sup>6</sup> / <sub>1</sub> , 5/ <sub>2</sub> , 4/ <sub>3</sub> , 2 <sup>6</sup> / <sub>1</sub>	4 <sup>2</sup> / <sub>5</sub> , 3 <sup>4</sup> / <sub>3</sub> , 2 <sup>2</sup> / <sub>5</sub> , 2 <sup>5</sup> / <sub>2</sub> , 4/ <sub>3</sub> , 3/ <sub>4</sub> , 1 <sup>6</sup> / <sub>1</sub> , 5/ <sub>2</sub> , 4/ <sub>3</sub> , 1/0 <sup>6</sup> / <sub>1</sub>
ALUMOWELD		2F, 4A, 5A, 5D, 6D, 3 No. 7, 7 No. 10, 3 No.8, 7 No. 11	2F, 4A, 5A, 5D, 6D, 3 No. 7, 7 No. 10, 3 No.8, 7 No. 11	2F, 4A, 5A, 5D, 6D, 3 No. 7, 7 No. 10, 3 No.8, 7 No. 11	1/0F, 1F, 1G, 1J, 2A, 2G, 2J, 2K, 3A, 4D, 4N, 4P, 3 No. 5, 7 No. 8, 3 No. 6, 7 No. 9
COPPERWELD					
Galvanized Steel		9/ <sub>32</sub> " , 5/ <sub>16</sub> "	9/ <sub>32</sub> " , 5/ <sub>16</sub> "	9/ <sub>32</sub> " , 5/ <sub>16</sub> "	11/ <sub>32</sub> " , 3/ <sub>8</sub> "
Solid: AL or CU		1	1, 2	1/0, 1	1/0



ACSR Standard Round		6 <sup>6</sup> / <sub>1</sub>	4 <sup>6</sup> / <sub>1</sub> , 7/ <sub>1</sub> , 5 <sup>6</sup> / <sub>1</sub>	2 <sup>6</sup> / <sub>1</sub> , 7/ <sub>1</sub> , 3 <sup>6</sup> / <sub>1</sub>	8 <sup>6</sup> / <sub>1</sub>
AAAC 6201 - 5003		6	4, 5	2, 3	–
AAC Standard Round		6	4, 5	2, 3	8
COPPER Standard Round		6	4, 5	2, 3	8
AAC Compressed or Compacted		6	3, 4	1, 2	8
ACSR Compressed or Compacted		6 <sup>6</sup> / <sub>1</sub>	4 <sup>6</sup> / <sub>1</sub> , 7/ <sub>1</sub>	2 <sup>6</sup> / <sub>1</sub> , 7/ <sub>1</sub>	–
AWAC, ACAR		–	4 <sup>6</sup> / <sub>1</sub>	4 <sup>5</sup> / <sub>2</sub> , 4/ <sub>3</sub> , 3/ <sub>4</sub> , 3 <sup>6</sup> / <sub>1</sub> , 5/ <sub>2</sub> , 3/ <sub>4</sub> , 2 <sup>6</sup> / <sub>1</sub>	–
ALUMOWELD		8A, 8C 3 No. 12	6A, 6C, 7A, 7D, 8D, 3 No. 9, 3 No. 10, 7 No. 12	2F, 4A, 5A, 5D, 6D, 3 No. 7, 7 No. 10, 3 No. 8, 7 No. 11	–
COPPERWELD					
Galvanized Steel		3/ <sub>16</sub> "	7/ <sub>32</sub> " , 1/ <sub>4</sub> "	9/ <sub>32</sub> " , 5/ <sub>16</sub> "	5/ <sub>32</sub> "
Solid: AL or CU		4, 5, 6	2, 3	1, 2	6, 8

Use TAP Number

600531\*

600528\*











600529\*

600533\*











Red coded taps are not sold in North America and should be substituted with white coded taps shown on the following pages.

\*UL Listed

## Aluminum Taps

Large Wire Groove Code		P	Q	N
ACSR Standard Round		1/0, 1 <sup>6</sup> / <sub>1</sub>	1/0, 1 <sup>6</sup> / <sub>1</sub>	1/0, 1 <sup>6</sup> / <sub>1</sub>
AAAC 6201 - 5003		1/0, 1	1/0, 1	1/0, 1
AAC Standard Round		1/0, 1	1/0, 1	1/0, 1
COPPER Standard Round		1/0, 1	1/0, 1	1/0, 1
AAC Compressed or Compacted		1/0	1/0	1/0
ACSR Compressed or Compacted		1/0, 1 <sup>6</sup> / <sub>1</sub>	1/0, 1 <sup>6</sup> / <sub>1</sub>	1/0, 1 <sup>6</sup> / <sub>1</sub>
AWAC, ACAR		4 <sup>2</sup> / <sub>5</sub> , 3 <sup>4</sup> / <sub>3</sub> , 2 <sup>5</sup> / <sub>5</sub> , 2 <sup>5</sup> / <sub>2</sub> , 4 <sup>3</sup> / <sub>3</sub> , 3 <sup>4</sup> / <sub>4</sub> , 1 <sup>6</sup> / <sub>1</sub> , 5 <sup>2</sup> / <sub>2</sub> , 4 <sup>3</sup> / <sub>3</sub> , 1/0 <sup>6</sup> / <sub>1</sub>	4 <sup>2</sup> / <sub>5</sub> , 3 <sup>4</sup> / <sub>3</sub> , 2 <sup>5</sup> / <sub>5</sub> , 2 <sup>5</sup> / <sub>2</sub> , 4 <sup>3</sup> / <sub>3</sub> , 3 <sup>4</sup> / <sub>4</sub> , 1 <sup>6</sup> / <sub>1</sub> , 5 <sup>2</sup> / <sub>2</sub> , 4 <sup>3</sup> / <sub>3</sub> , 1/0 <sup>6</sup> / <sub>1</sub>	4 <sup>2</sup> / <sub>5</sub> , 3 <sup>4</sup> / <sub>3</sub> , 2 <sup>5</sup> / <sub>5</sub> , 2 <sup>5</sup> / <sub>2</sub> , 4 <sup>3</sup> / <sub>3</sub> , 3 <sup>4</sup> / <sub>4</sub> , 1 <sup>6</sup> / <sub>1</sub> , 5 <sup>2</sup> / <sub>2</sub> , 4 <sup>3</sup> / <sub>3</sub> , 1/0 <sup>6</sup> / <sub>1</sub>
ALUMOWELD		1/0F, 1F, 1G, 1J, 2A, 2G, 2J, 2K, 3A, 4D, 4N, 4P, 3 No. 5, 7 No. 8, 3 No. 6, 7 No. 9	1/0F, 1F, 1G, 1J, 2A, 2G, 2J, 2K, 3A, 4D, 4N, 4P, 3 No. 5, 7 No. 8, 3 No. 6, 7 No. 9	1/0F, 1F, 1G, 1J, 2A, 2G, 2J, 2K, 3A, 4D, 4N, 4P, 3 No. 5, 7 No. 8, 3 No. 6, 7 No. 9
COPPERWELD				
Galvanized Steel		1 <sup>1</sup> / <sub>32</sub> " , 3 <sup>3</sup> / <sub>8</sub> "	1 <sup>1</sup> / <sub>32</sub> " , 3 <sup>3</sup> / <sub>8</sub> "	1 <sup>1</sup> / <sub>32</sub> " , 3 <sup>3</sup> / <sub>8</sub> "
Solid: AL or CU		1/0	1/0	—













ACSR Standard Round		6 <sup>6</sup> / <sub>1</sub>	4 <sup>6</sup> / <sub>1</sub> , 7 <sup>1</sup> / <sub>1</sub> , 5 <sup>6</sup> / <sub>1</sub>	2 <sup>6</sup> / <sub>1</sub> , 7 <sup>1</sup> / <sub>1</sub> , 3 <sup>6</sup> / <sub>1</sub>
AAAC 6201 - 5003		6	4, 5	2, 3
AAC Standard Round		6	4, 5	2, 3
COPPER Standard Round		6	4, 5	2, 3
AAC Compressed or Compacted		6	3, 4	1, 2
ACSR Compressed or Compacted		6 <sup>6</sup> / <sub>1</sub>	5 <sup>6</sup> / <sub>1</sub> , 7 <sup>1</sup> / <sub>1</sub>	2 <sup>6</sup> / <sub>1</sub> , 7 <sup>1</sup> / <sub>1</sub>
AWAC, ACAR		—	4 <sup>6</sup> / <sub>1</sub>	4 <sup>5</sup> / <sub>2</sub> , 4 <sup>3</sup> / <sub>3</sub> , 3 <sup>4</sup> / <sub>4</sub> , 3 <sup>6</sup> / <sub>1</sub> , 5 <sup>2</sup> / <sub>2</sub> , 4 <sup>3</sup> / <sub>3</sub> , 2 <sup>6</sup> / <sub>1</sub>
ALUMOWELD		8A, 8C 3 No. 12	6A, 6C, 7A, 7D, 8D, 3 No. 9, 3 No. 10, 7 No. 12	2F, 4A, 5A, 5D, 6D, 3 No. 7, 7 No. 10, 3 No. 8, 7 No. 11
COPPERWELD				
Galvanized Steel		3 <sup>3</sup> / <sub>16</sub> "	7 <sup>7</sup> / <sub>32</sub> " , 1 <sup>1</sup> / <sub>4</sub> "	9 <sup>9</sup> / <sub>32</sub> " , 5 <sup>5</sup> / <sub>16</sub> "
Solid: AL or CU		4, 5, 6	2, 3	1











Use TAP Number **600528\*** **600529\*** **600525**

Red coded taps are not sold in North America and should be substituted with white coded taps.

\*UL Listed

Large Wire Groove Code		U	X	R	X	R	S
ACSR Standard Round		8 <sup>6</sup> / <sub>1</sub>	6 <sup>6</sup> / <sub>1</sub>	6 <sup>6</sup> / <sub>1</sub>	4 <sup>6</sup> / <sub>1</sub> , 7 <sup>1</sup> / <sub>1</sub> , 5 <sup>6</sup> / <sub>1</sub>	4 <sup>6</sup> / <sub>1</sub> , 7 <sup>1</sup> / <sub>1</sub> , 5 <sup>6</sup> / <sub>1</sub>	4 <sup>6</sup> / <sub>1</sub> , 7 <sup>1</sup> / <sub>1</sub> , 5 <sup>6</sup> / <sub>1</sub>
AAAC 6201 - 5003		-	6	6	4, 5	4, 5	4, 5
AAC Standard Round		8	6	6	4, 5	4, 5	4, 5
COPPER Standard Round		8	6	6	4, 5	4, 5	4, 5
AAC Compressed or Compacted		8	6	6	3, 4	3, 4	3, 4
ACSR Compressed or Compacted		-	6 <sup>6</sup> / <sub>1</sub>	6 <sup>6</sup> / <sub>1</sub>	4 <sup>6</sup> / <sub>1</sub> , 7 <sup>1</sup> / <sub>1</sub>	4 <sup>6</sup> / <sub>1</sub> , 7 <sup>1</sup> / <sub>1</sub>	4 <sup>6</sup> / <sub>1</sub> , 7 <sup>1</sup> / <sub>1</sub>
AWAC, ACAR		-	-	-	4 <sup>6</sup> / <sub>1</sub>	4 <sup>6</sup> / <sub>1</sub>	4 <sup>6</sup> / <sub>1</sub>
ALUMOWELD		-	8A, 8C, 3 No. 12	8A, 8C, 3 No. 12	6A, 6C, 7A, 7D, 8D, 3 No. 9, 3 No. 10, 7 No. 12	6A, 6C, 7A, 7D, 8D, 3 No. 9, 3 No. 10, 7 No. 12	6A, 6C, 7A, 7D, 8D, 3 No. 9, 3 No. 10, 7 No. 12
COPPERWELD		-	8A, 8C, 3 No. 12	8A, 8C, 3 No. 12	6A, 6C, 7A, 7D, 8D, 3 No. 9, 3 No. 10, 7 No. 12	6A, 6C, 7A, 7D, 8D, 3 No. 9, 3 No. 10, 7 No. 12	6A, 6C, 7A, 7D, 8D, 3 No. 9, 3 No. 10, 7 No. 12
Galvanized Steel		5/32"	3/16"	3/16"	7/32", 1/4"	7/32", 1/4"	7/32", 1/4"
Solid: AL or CU		6, 8	4, 5	4, 5	2, 3	2, 3	2, 3













ACSR Standard Round		8 <sup>6</sup> / <sub>1</sub>	8 <sup>6</sup> / <sub>1</sub>	6 <sup>6</sup> / <sub>1</sub>	8 <sup>6</sup> / <sub>1</sub>	6 <sup>6</sup> / <sub>1</sub>	4 <sup>6</sup> / <sub>1</sub> , 7 <sup>1</sup> / <sub>1</sub> , 5 <sup>6</sup> / <sub>1</sub>
AAAC 6201 - 5003		-	-	6	-	6	4, 5
AAC Standard Round		8	8	6	8	6	4, 5
COPPER Standard Round		8	8	6	8	6	4, 5
AAC Compressed or Compacted		8	8	6	8	6	3, 4
ACSR Compressed or Compacted		-	-	6 <sup>6</sup> / <sub>1</sub>	-	6 <sup>6</sup> / <sub>1</sub>	4 <sup>6</sup> / <sub>1</sub> , 7 <sup>1</sup> / <sub>1</sub>
AWAC, ACAR		-	-	-	-	-	4 <sup>6</sup> / <sub>1</sub>
ALUMOWELD		-	-	8A, 8C 3 No.12	-	8A, 8C 3 No. 12	6A, 6C, 7A, 7D, 8D, 3 No. 9, 7 No. 12, 3 No. 10,
COPPERWELD		-	-	8A, 8C 3 No.12	-	8A, 8C 3 No. 12	7 No. 12, 3 No. 10,
Galvanized Steel		5/32"	5/32"	3/16"	5/32"	3/16"	7/32", 1/4"
Solid: AL or CU		6, 8	8	4, 5, 6	8	5, 6	3, 4

**Use TAP Number**      **602283-5\***      **602283-8**      **602283-4\***      **602283-8**      **602283-4\***      **602283-3\***









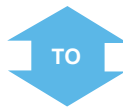
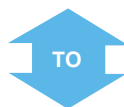

White - Coded Type II Aluminum Taps - Aluminum to Aluminum, Aluminum to Copper, Copper to Copper (in non-corrosive environments)

\*UL Listed

Aluminum Taps

Large Wire Groove Code	Y	S	P	Q	W
ACSR Standard Round 	2 <sup>6</sup> / <sub>1</sub> , 7 <sub>1</sub> , 3 <sup>6</sup> / <sub>1</sub>	2 <sup>6</sup> / <sub>1</sub> , 7 <sub>1</sub> , 3 <sup>6</sup> / <sub>1</sub>	2 <sup>6</sup> / <sub>1</sub> , 7 <sub>1</sub> , 3 <sup>6</sup> / <sub>1</sub>	2 <sup>6</sup> / <sub>1</sub> , 7 <sub>1</sub> , 3 <sup>6</sup> / <sub>1</sub>	1/0, 1 <sup>6</sup> / <sub>1</sub>
AAAC 6201 - 5003 	2, 3	2, 3	2, 3	2, 3	1/0, 1
AAC Standard Round 	2, 3	2, 3	2, 3	2, 3	1/0, 1
COPPER Standard Round 	2, 3	2, 3	2, 3	2, 3	1/0, 1
AAC Compressed or Compacted 	1, 2	1, 2	1, 2	1, 2	1/0
ACSR Compressed or Compacted 	2 <sup>6</sup> / <sub>1</sub> , 7 <sub>1</sub>	2 <sup>6</sup> / <sub>1</sub> , 7 <sub>1</sub>	2 <sup>6</sup> / <sub>1</sub> , 7 <sub>1</sub>	2 <sup>6</sup> / <sub>1</sub> , 7 <sub>1</sub>	1/0, 1 <sup>6</sup> / <sub>1</sub>
AWAC, ACAR 	4 <sup>5</sup> / <sub>2</sub> , 4 <sub>3</sub> , 3 <sub>4</sub> , 3 <sup>6</sup> / <sub>1</sub> , 5 <sub>2</sub> , 4 <sub>3</sub> , 2 <sup>6</sup> / <sub>1</sub>	4 <sup>5</sup> / <sub>2</sub> , 4 <sub>3</sub> , 3 <sub>4</sub> , 3 <sup>6</sup> / <sub>1</sub> , 5 <sub>2</sub> , 4 <sub>3</sub> , 2 <sup>6</sup> / <sub>1</sub>	4 <sup>5</sup> / <sub>2</sub> , 4 <sub>3</sub> , 3 <sub>4</sub> , 3 <sup>6</sup> / <sub>1</sub> , 5 <sub>2</sub> , 4 <sub>3</sub> , 2 <sup>6</sup> / <sub>1</sub>	4 <sup>5</sup> / <sub>2</sub> , 4 <sub>3</sub> , 3 <sub>4</sub> , 3 <sup>6</sup> / <sub>1</sub> , 5 <sub>2</sub> , 4 <sub>3</sub> , 2 <sup>6</sup> / <sub>1</sub>	4 <sup>2</sup> / <sub>5</sub> , 3 <sup>3</sup> / <sub>4</sub> , 2 <sub>5</sub> , 2 <sup>5</sup> / <sub>2</sub> , 4 <sub>3</sub> , 3 <sub>4</sub> , 1 <sup>6</sup> / <sub>1</sub> , 5 <sub>2</sub> , 4 <sub>3</sub> , 1/0 <sup>6</sup> / <sub>1</sub>
ALUMOWELD COPPERWELD 	2F, 4A, 5A, 5D, 6D, 3 No. 7, 7 No. 10, 3 No. 8, 7 No. 11	2F, 4A, 5A, 5D, 6D, 3 No. 7, 7 No. 10, 3 No. 8, 7 No. 11	2F, 4A, 5A, 5D, 6D, 3 No. 7, 3 No. 8, 7 No. 10, 7 No. 11	2F, 4A, 5A, 5D, 6D, 3 No. 7, 3 No. 8, 7 No. 10, 7 No. 11	1/0F, 1F, 1G, 1J, 2A, 2G, 2J, 2K, 3A, 4D, 4N, 4P, 3 No. 5, 3 No. 6, 7 No. 8, 7 No.9
Galvanized Steel 	9 <sub>32</sub> " , 5 <sub>16</sub> "	9 <sub>32</sub> " , 5 <sub>16</sub> "	9 <sub>32</sub> " , 5 <sub>16</sub> "	9 <sub>32</sub> " , 5 <sub>16</sub> "	11 <sub>32</sub> " , 3 <sub>8</sub> "
Solid: AL or CU 	1	1	1, 2	1/0, 1	1/0













ACSR Standard Round 	8 <sup>6</sup> / <sub>1</sub>	6 <sup>6</sup> / <sub>1</sub>	4 <sup>6</sup> / <sub>1</sub> , 7 <sub>1</sub> , 5 <sup>6</sup> / <sub>1</sub>	2 <sup>6</sup> / <sub>1</sub> , 7 <sub>1</sub> , 3 <sup>6</sup> / <sub>1</sub>	8 <sup>6</sup> / <sub>1</sub>
AAAC 6201 - 5003 	-	6	4, 5	2, 3	-
AAC Standard Round 	8	6	4, 5	2, 3	8
COPPER Standard Round 	8	6	4, 5	2, 3	8
AAC Compressed or Compacted 	8	6	3, 4	1, 2	8
ACSR Compressed or Compacted 	-	6 <sup>6</sup> / <sub>1</sub>	4 <sup>6</sup> / <sub>1</sub> , 7 <sub>1</sub>	2 <sup>6</sup> / <sub>1</sub> , 7 <sub>1</sub>	-
AWAC, ACAR 	-	-	4 <sup>6</sup> / <sub>1</sub>	4 <sup>5</sup> / <sub>2</sub> , 4 <sub>3</sub> , 3 <sub>4</sub> , 3 <sup>6</sup> / <sub>1</sub> , 5 <sub>2</sub> , 4 <sub>3</sub> , 2 <sup>6</sup> / <sub>1</sub>	-
ALUMOWELD COPPERWELD 	-	8A, 8C 3 No. 12	6A, 6C, 7A, 7D, 8D, 3 No. 9, 3 No. 10, 7 No. 12	2F, 4A, 5A, 5D, 6D, 3 No. 7, 7 No. 10, 3 No. 8, 7 No. 11	-
Galvanized Steel 	5 <sub>32</sub> "	3 <sub>16</sub> "	7 <sub>32</sub> " , 1 <sub>4</sub> "	3 <sub>32</sub> " , 5 <sub>16</sub> "	5 <sub>32</sub> "
Solid: AL or CU 	6, 8	4, 5, 6	2, 3	1, 2	6, 8

<b>Use TAP Number</b>	<b>602283-7</b>	<b>602283-3*</b>	<b>602283-2*</b>	<b>602283-1*</b>	<b>602283-6</b>
-----------------------	-----------------	------------------	------------------	------------------	-----------------











White - Coded Type II Aluminum Taps - Aluminum to Aluminum, Aluminum to Copper, Copper to Copper (in non-corrosive environments)

\*UL Listed

Aluminum Taps

Large Wire Groove Code	P	Q	N
ACSR Standard Round 	1/0, 1 <sup>6</sup> / <sub>1</sub>	1/0, 1 <sup>6</sup> / <sub>1</sub>	1/0, 1 <sup>6</sup> / <sub>1</sub> , 2 <sup>6</sup> / <sub>1</sub> , 7 <sub>1</sub>
AAAC 6201 - 5003 	1/0, 1	1/0, 1	1/0, 1
AAC Standard Round 	1/0, 1	1/0, 1	1/0, 1
COPPER Standard Round 	1/0, 1	1/0, 1	1/0, 1
AAC Compressed or Compacted 	1/0, 1	1/0	1/0
ACSR Compressed or Compacted 	1/0, 1 <sup>6</sup> / <sub>1</sub>	1/0, 1 <sup>6</sup> / <sub>1</sub>	1/0, 1 <sup>6</sup> / <sub>1</sub>
AWAC, ACAR 	4 <sup>2</sup> / <sub>5</sub> , 3 <sup>3</sup> / <sub>4</sub> , 2 <sup>2</sup> / <sub>5</sub> , 2 <sup>5</sup> / <sub>2</sub> , 4 <sup>4</sup> / <sub>3</sub> , 3 <sup>3</sup> / <sub>4</sub> , 1 <sup>6</sup> / <sub>1</sub> , 5 <sup>2</sup> / <sub>2</sub> , 4 <sup>4</sup> / <sub>3</sub> , 1/0 <sup>6</sup> / <sub>1</sub>	4 <sup>2</sup> / <sub>5</sub> , 3 <sup>3</sup> / <sub>4</sub> , 2 <sup>2</sup> / <sub>5</sub> , 2 <sup>5</sup> / <sub>2</sub> , 4 <sup>4</sup> / <sub>3</sub> , 3 <sup>3</sup> / <sub>4</sub> , 1 <sup>6</sup> / <sub>1</sub> , 5 <sup>2</sup> / <sub>2</sub> , 4 <sup>4</sup> / <sub>3</sub> , 1/0 <sup>6</sup> / <sub>1</sub>	4 <sup>2</sup> / <sub>5</sub> , 3 <sup>3</sup> / <sub>4</sub> , 2 <sup>2</sup> / <sub>5</sub> , 2 <sup>5</sup> / <sub>2</sub> , 4 <sup>4</sup> / <sub>3</sub> , 3 <sup>3</sup> / <sub>4</sub> , 1 <sup>6</sup> / <sub>1</sub> , 5 <sup>2</sup> / <sub>2</sub> , 4 <sup>4</sup> / <sub>3</sub> , 1/0 <sup>6</sup> / <sub>1</sub>
ALUMOWELD  COPPERWELD 	1/0F, 1F, 1G, 1J, 2A, 2G, 2J, 2K, 3A, 4D, 4N, 4P, 3 No. 5, 7 No. 8, 3 No. 6, 7 No. 9	1/0F, 1F, 1G, 1J, 2A, 2G, 2J, 2K, 3A, 4D, 4N, 4P, 3 No. 5, 7 No. 8, 3 No. 6, 7 No. 9	1/0F, 1F, 1G, 1J, 2A, 2G, 2J, 2K, 3A, 4D, 4N, 4P, 3 No. 5, 7 No. 8, 3 No. 6, 7 No. 9
Galvanized Steel 	1 <sup>1</sup> / <sub>32</sub> " , 3 <sup>3</sup> / <sub>8</sub> "	1 <sup>1</sup> / <sub>32</sub> " , 3 <sup>3</sup> / <sub>8</sub> "	1 <sup>1</sup> / <sub>32</sub> " , 3 <sup>3</sup> / <sub>8</sub> "
Solid: AL or CU 	1/0	1/0	—













ACSR Standard Round 	6 <sup>6</sup> / <sub>1</sub>	4 <sup>6</sup> / <sub>1</sub> , 7 <sub>1</sub> , 5 <sup>6</sup> / <sub>1</sub>	2 <sup>6</sup> / <sub>1</sub> , 7 <sub>1</sub> , 3 <sup>6</sup> / <sub>1</sub>
AAAC 6201 - 5003 	6	4, 5	2, 3
AAC Standard Round 	6	4, 5	2, 3
COPPER Standard Round 	6	4, 5	2, 3
AAC Compressed or Compacted 	6	3, 4	1, 2
ACSR Compressed or Compacted 	6 <sup>6</sup> / <sub>1</sub>	4 <sup>6</sup> / <sub>1</sub> , 7 <sub>1</sub>	2 <sup>6</sup> / <sub>1</sub> , 7 <sub>1</sub>
AWAC, ACAR 	—	4 <sup>6</sup> / <sub>1</sub>	4 <sup>5</sup> / <sub>2</sub> , 4 <sup>4</sup> / <sub>3</sub> , 3 <sup>3</sup> / <sub>4</sub> , 3 <sup>6</sup> / <sub>1</sub> , 5 <sup>2</sup> / <sub>2</sub> , 4 <sup>4</sup> / <sub>3</sub> , 2 <sup>6</sup> / <sub>1</sub>
ALUMOWELD  COPPERWELD 	8A, 8C 3 No. 12	6A, 6C, 7A, 7D, 8D, 3 No. 9, 3 No. 10, 7 No. 12	2F, 4A, 5A, 5D, 6D, 3 No. 7, 3 No. 8, 7 No. 10, 7 No. 11
Galvanized Steel 	3 <sup>3</sup> / <sub>16</sub> "	7 <sup>7</sup> / <sub>32</sub> " , 1 <sup>1</sup> / <sub>4</sub> "	9 <sup>9</sup> / <sub>32</sub> " , 5 <sup>5</sup> / <sub>16</sub> "
Solid: AL or CU 	4, 5, 6	2, 3	1

<b>Use TAP Number</b>	<b>602283-2*</b>	<b>602283-1*</b>	<b>602283*</b>
-----------------------	------------------	------------------	----------------









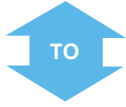

White - Coded Type II Aluminum Taps - Aluminum to Aluminum, Aluminum to Copper, Copper to Copper (in non-corrosive environments)

\*UL Listed

Aluminum Taps

Large Wire Groove Code	A	C	D	A	E	T
ACSR Standard Round 	1/0, 1 <sup>6</sup> / <sub>1</sub> 2 <sup>6</sup> / <sub>1</sub> , 7 <sub>1</sub>	2/0, 1/0 <sup>6</sup> / <sub>1</sub>	2/0, 1/0 <sup>6</sup> / <sub>1</sub>	2/0, 1/0 <sup>6</sup> / <sub>1</sub>	2/0, 1/0 <sup>6</sup> / <sub>1</sub>	2/0, 1/0 <sup>6</sup> / <sub>1</sub>
AAAC 6201 - 5003 	1/0, 1, 2	2/0, 1/0	2/0, 1/0	2/0, 1/0	2/0, 1/0	2/0, 1/0
AAC Standard Round 	1/0, 1	2/0	2/0	2/0	2/0	2/0
COPPER Standard Round 	1/0, 1	2/0	2/0	2/0	2/0	2/0
AAC Compressed or Compacted 	1/0	2/0	2/0	2/0	2/0	2/0
ACSR Compressed or Compacted 	1/0, 1 <sup>6</sup> / <sub>1</sub>	2/0 <sup>6</sup> / <sub>1</sub>	2/0 <sup>6</sup> / <sub>1</sub>	2/0 <sup>6</sup> / <sub>1</sub>	2/0 <sup>6</sup> / <sub>1</sub>	2/0 <sup>6</sup> / <sub>1</sub>
AWAC, ACAR 	4 <sup>2</sup> / <sub>5</sub> , 3 <sup>4</sup> / <sub>4</sub> , 3 <sup>4</sup> / <sub>3</sub> , 3 <sup>4</sup> / <sub>4</sub> , 2 <sup>5</sup> / <sub>5</sub> , 2 <sup>6</sup> / <sub>1</sub> , 5 <sup>2</sup> / <sub>2</sub> , 4 <sup>3</sup> / <sub>3</sub> , 3 <sup>4</sup> / <sub>4</sub> , 1 <sup>6</sup> / <sub>1</sub> , 5 <sup>2</sup> / <sub>2</sub> , 4 <sup>3</sup> / <sub>3</sub> , 1/0 <sup>6</sup> / <sub>1</sub>	2 <sup>2</sup> / <sub>5</sub> , 1 <sup>3</sup> / <sub>4</sub> , 1/0 <sup>5</sup> / <sub>2</sub> , 4 <sup>3</sup> / <sub>3</sub> , 2/0 <sup>6</sup> / <sub>1</sub>	2 <sup>2</sup> / <sub>5</sub> , 1 <sup>3</sup> / <sub>4</sub> , 1/0 <sup>5</sup> / <sub>2</sub> , 4 <sup>3</sup> / <sub>3</sub> , 2/0 <sup>6</sup> / <sub>1</sub>	2 <sup>2</sup> / <sub>5</sub> , 1 <sup>3</sup> / <sub>4</sub> , 1/0 <sup>5</sup> / <sub>2</sub> , 4 <sup>3</sup> / <sub>3</sub> , 2/0 <sup>6</sup> / <sub>1</sub>	2 <sup>2</sup> / <sub>5</sub> , 1 <sup>3</sup> / <sub>4</sub> , 1/0 <sup>5</sup> / <sub>2</sub> , 4 <sup>3</sup> / <sub>3</sub> , 2/0 <sup>6</sup> / <sub>1</sub>	2 <sup>2</sup> / <sub>5</sub> , 1 <sup>3</sup> / <sub>4</sub> , 1/0 <sup>5</sup> / <sub>2</sub> , 4 <sup>3</sup> / <sub>3</sub> , 2/0 <sup>6</sup> / <sub>1</sub>
ALUMOWELD 	1/0F, 1F, 1G, 1J, 2A, 2F, 2G, 2J, 2K, 3A, 4D, 4N, 4P, 5D, 3 No. 5, 6 or 7, 7 No. 8, 9 or 10	2/0F, 1/0G, 1/0J, 1K, 2N, 7 No. 7	2/0F, 1/0G, 1/0J, 1K, 2N, 7 No. 7	2/0F, 1/0G, 1/0J, 1K, 2N, 7 No. 7	2/0F, 1/0G, 1/0J, 1K, 2N, 7 No. 7	2/0F, 1/0G, 1/0J, 1K, 2N, 7 No. 7
COPPERWELD						
Galvanized Steel 	5 <sup>1</sup> / <sub>16</sub> " , 1 <sup>1</sup> / <sub>32</sub> " , 3 <sup>3</sup> / <sub>8</sub> "	7 <sup>1</sup> / <sub>16</sub> "	7 <sup>1</sup> / <sub>16</sub> "	7 <sup>1</sup> / <sub>16</sub> "	7 <sup>1</sup> / <sub>16</sub> "	7 <sup>1</sup> / <sub>16</sub> "
Solid: AL or CU 	2/0, 1/0	3/0	3/0	3/0, 2/0	3/0, 2/0	3/0, 2/0













ACSR Standard Round 	1/0, 1 <sup>6</sup> / <sub>1</sub> 2 <sup>6</sup> / <sub>1</sub> , 7 <sub>1</sub>	6 <sup>6</sup> / <sub>1</sub>	4 <sup>6</sup> / <sub>1</sub> , 7 <sub>1</sub> , 5 <sup>6</sup> / <sub>1</sub>	2 <sup>6</sup> / <sub>1</sub> , 7 <sub>1</sub> , 3 <sup>6</sup> / <sub>1</sub>	1/0, 1 <sup>6</sup> / <sub>1</sub>	2/0 <sup>6</sup> / <sub>1</sub>
AAAC 6201 - 5003 	1, 2	6, 5	4	2, 3	1/0, 1	2/0
AAC Standard Round 	1/0, 1	6, 5	4	2, 3	1/0, 1	2/0
COPPER Standard Round 	1/0, 1	6, 5	4	2, 3	1/0, 1	2/0
AAC Compressed or Compacted 	1/0	6	3, 4	1, 2	1/0	2/0
ACSR Compressed or Compacted 	1/0, 1 <sup>6</sup> / <sub>1</sub>	6 <sup>6</sup> / <sub>1</sub>	4 <sup>6</sup> / <sub>1</sub> , 7 <sub>1</sub>	2 <sup>6</sup> / <sub>1</sub> , 7 <sub>1</sub>	1/0, 1 <sup>6</sup> / <sub>1</sub>	2/0 <sup>6</sup> / <sub>1</sub>
AWAC, ACAR 	4 <sup>2</sup> / <sub>5</sub> , 3 <sup>4</sup> / <sub>4</sub> , 3 <sup>4</sup> / <sub>3</sub> , 3 <sup>4</sup> / <sub>4</sub> , 2 <sup>5</sup> / <sub>5</sub> , 2 <sup>6</sup> / <sub>1</sub> , 5 <sup>2</sup> / <sub>2</sub> , 4 <sup>3</sup> / <sub>3</sub> , 3 <sup>4</sup> / <sub>4</sub> , 1 <sup>6</sup> / <sub>1</sub> , 5 <sup>2</sup> / <sub>2</sub> , 4 <sup>3</sup> / <sub>3</sub> , 1/0 <sup>6</sup> / <sub>1</sub>	-	4 <sup>6</sup> / <sub>1</sub>	4 <sup>5</sup> / <sub>2</sub> , 4 <sup>3</sup> / <sub>3</sub> , 3 <sup>4</sup> / <sub>4</sub> , 3 <sup>6</sup> / <sub>1</sub> , 5 <sup>2</sup> / <sub>2</sub> , 4 <sup>3</sup> / <sub>3</sub> , 2 <sup>6</sup> / <sub>1</sub>	4 <sup>2</sup> / <sub>5</sub> , 3 <sup>3</sup> / <sub>4</sub> , 2 <sup>5</sup> / <sub>5</sub> , 2 <sup>5</sup> / <sub>2</sub> , 4 <sup>3</sup> / <sub>3</sub> , 3 <sup>4</sup> / <sub>4</sub> , 1 <sup>6</sup> / <sub>1</sub> , 5 <sup>2</sup> / <sub>2</sub> , 4 <sup>3</sup> / <sub>3</sub> , 1/0 <sup>6</sup> / <sub>1</sub>	2 <sup>2</sup> / <sub>5</sub> , 1 <sup>3</sup> / <sub>4</sub> , 1/0 <sup>5</sup> / <sub>2</sub> , 4 <sup>3</sup> / <sub>3</sub> , 2/0 <sup>6</sup> / <sub>1</sub>
ALUMOWELD 	1/0F, 1F, 1G, 1J, 2A, 2F, 2G, 2J, 2K, 3A, 4D, 4N, 4P, 5D, 3 No. 5, 6 or 7; 7 No. 8, 9 or 10	8A, 8C, 3 No. 12	6A, 6C, 7A, 7D, 8D, 3 No. 9, 3 No. 10, 7 No. 12	2F, 4A, 5A, 5D, 6D, 3 No. 7, 3 No. 8, 7 No. 10, 7 No. 11	1/0F, 1F, 1G, 1J, 2A, 2F, 2G, 2J, 2K, 3A, 4D, 4N, 4P, 3 No. 5, 3 No. 6, 7 No. 8, 7 No. 9	2/0F, 1/0G, 1/0J, 1K, 2N, 7 No. 7
COPPERWELD						
Galvanized Steel 	5 <sup>1</sup> / <sub>16</sub> " , 1 <sup>1</sup> / <sub>32</sub> " , 3 <sup>3</sup> / <sub>8</sub> "	3 <sup>3</sup> / <sub>16</sub> "	7 <sup>1</sup> / <sub>32</sub> " , 1 <sup>1</sup> / <sub>4</sub> "	9 <sup>1</sup> / <sub>32</sub> " , 5 <sup>1</sup> / <sub>16</sub> "	1 <sup>1</sup> / <sub>32</sub> " , 3 <sup>3</sup> / <sub>8</sub> "	7 <sup>1</sup> / <sub>16</sub> "
Solid: AL or CU 	1/0	4, 5, 6	2, 3	1/0, 1, 2	2/0	3/0









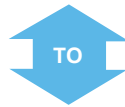

Use TAP Number	600403*	600446*	600447*	600403*	600448	600411*
----------------	---------	---------	---------	---------	--------	---------

\*UL Listed

## Aluminum Taps

Large Wire Groove Code	C	D	E	T	K	H
ACSR Standard Round 	3/0 <sup>6</sup> /1	3/0 <sup>6</sup> /1	3/0 <sup>6</sup> /1	3/0 <sup>6</sup> /1	3/0 <sup>6</sup> /1	3/0 <sup>6</sup> /1
AAAC 6201 - 5003 	3/0	3/0	3/0	3/0	3/0	3/0
AAC Standard Round 	3/0	3/0	3/0	3/0	3/0	3/0
COPPER Standard Round 	3/0	3/0	3/0	3/0	3/0	3/0
AAC Compressed or Compacted 	3/0	3/0	3/0	3/0	3/0	3/0
ACSR Compressed or Compacted 	3/0 <sup>6</sup> /1	3/0 <sup>6</sup> /1	3/0 <sup>6</sup> /1	3/0 <sup>6</sup> /1	3/0 <sup>6</sup> /1	3/0 <sup>6</sup> /1
AWAC, ACAR 	1 <sup>2</sup> / <sub>5</sub> , 1/0 <sup>3</sup> / <sub>4</sub> , 2/0 <sup>5</sup> / <sub>2</sub> , 4/ <sub>3</sub> , 3/0 <sup>6</sup> / <sub>1</sub>	1 <sup>2</sup> / <sub>5</sub> , 1/0 <sup>3</sup> / <sub>4</sub> , 2/0 <sup>5</sup> / <sub>2</sub> , 4/ <sub>3</sub> , 3/0 <sup>6</sup> / <sub>1</sub>	1 <sup>2</sup> / <sub>5</sub> , 1/0 <sup>3</sup> / <sub>4</sub> , 2/0 <sup>5</sup> / <sub>2</sub> , 4/ <sub>3</sub> , 3/0 <sup>6</sup> / <sub>1</sub>	1 <sup>2</sup> / <sub>5</sub> , 1/0 <sup>3</sup> / <sub>4</sub> , 2/0 <sup>5</sup> / <sub>2</sub> , 4/ <sub>3</sub> , 3/0 <sup>6</sup> / <sub>1</sub>	1 <sup>2</sup> / <sub>5</sub> , 1/0 <sup>3</sup> / <sub>4</sub> , 2/0 <sup>5</sup> / <sub>2</sub> , 4/ <sub>3</sub> , 3/0 <sup>6</sup> / <sub>1</sub>	1 <sup>2</sup> / <sub>5</sub> , 1/0 <sup>3</sup> / <sub>4</sub> , 2/0 <sup>5</sup> / <sub>2</sub> , 4/ <sub>3</sub> , 3/0 <sup>6</sup> / <sub>1</sub>
ALUMOWELD COPPERWELD 	3/0F, 2/0G, 2/0J, 1/0F, 1N, 2P, 7 No. 7	3/0F, 2/0G, 2/0J, 1/0F, 1N, 2P, 7 No. 6	3/0F, 2/0G, 2/0J, 1/0F, 1N, 2P, 7 No. 6	3/0F, 2/0G, 2/0J, 1/0F, 1N, 2P, 7 No. 6	3/0F, 2/0G, 2/0J, 1/0F, 1N, 2P, 7 No. 6	3/0F, 2/0G, 2/0J, 1/0F, 1N, 2P, 7 No. 6
Galvanized Steel 	1/2"	1/2"	1/2"	1/2"	1/2"	1/2"
Solid: AL or CU 	4/0	4/0	4/0	4/0	4/0	4/0



ACSR Standard Round 	6 <sup>6</sup> / <sub>1</sub>	4 <sup>6</sup> / <sub>1</sub> , 7/ <sub>1</sub> , 5 <sup>6</sup> / <sub>1</sub>	2 <sup>6</sup> / <sub>1</sub> , 7/ <sub>1</sub> , 3 <sup>6</sup> / <sub>1</sub>	1/0, 1 <sup>6</sup> / <sub>1</sub>	2/0 <sup>6</sup> / <sub>1</sub>	3/0 <sup>6</sup> / <sub>1</sub>
AAAC 6201 - 5003 	6	4, 5	2, 3	1/0, 1	2/0	3/0
AAC Standard Round 	6	4, 5	2, 3	1/0, 1	2/0	3/0
COPPER Standard Round 	6	4, 5	2, 3	1/0, 1	2/0	3/0
AAC Compressed or Compacted 	6	3, 4	1, 2	1/0	2/0	3/0
ACSR Compressed or Compacted 	6 <sup>6</sup> / <sub>1</sub>	4 <sup>6</sup> / <sub>1</sub> , 7/ <sub>1</sub>	2 <sup>6</sup> / <sub>1</sub> , 7/ <sub>1</sub>	1/0, 1 <sup>6</sup> / <sub>1</sub>	2/0 <sup>6</sup> / <sub>1</sub>	3/0 <sup>6</sup> / <sub>1</sub>
AWAC, ACAR 	-	4 <sup>6</sup> / <sub>1</sub>	4 <sup>5</sup> / <sub>2</sub> , 4/ <sub>3</sub> , 3/ <sub>4</sub> , 3 <sup>6</sup> / <sub>1</sub> , 5/ <sub>2</sub> , 4/ <sub>3</sub> , 2 <sup>6</sup> / <sub>1</sub>	4 <sup>2</sup> / <sub>5</sub> , 3 <sup>3</sup> / <sub>4</sub> , 2/ <sub>5</sub> , 2 <sup>5</sup> / <sub>2</sub> , 4/ <sub>3</sub> , 3/ <sub>4</sub> , 1 <sup>6</sup> / <sub>1</sub> , 5/ <sub>2</sub> , 4/ <sub>3</sub> , 1/0 <sup>6</sup> / <sub>1</sub>	2 <sup>2</sup> / <sub>5</sub> , 1 <sup>3</sup> / <sub>4</sub> , 1/0 <sup>5</sup> / <sub>2</sub> , 4/ <sub>3</sub> , 2/0 <sup>6</sup> / <sub>1</sub>	1 <sup>2</sup> / <sub>5</sub> , 1/0 <sup>3</sup> / <sub>4</sub> , 2/0 <sup>5</sup> / <sub>2</sub> , 4/ <sub>3</sub> , 3/0 <sup>6</sup> / <sub>1</sub>
ALUMOWELD COPPERWELD 	8A, 8C, 3 No. 12	6A, 6C, 7A, 7D, 8D, 3 No. 9, 3 No. 10, 7 No. 12	2F, 4A, 5A, 5D, 6D, 3 No. 7, 3 No. 8, 7 No. 10, 7 No. 11	1/0F, 1F, 1G, 1J, 2A, 2G, 2J, 2K, 3A, 4D, 4N, 4P, 3 No. 5, 7 No. 8, 3 No. 6, 7 No. 9	2/0F, 1/0G, 1/0J, 1K, 2N, 7 No. 7	3/0F, 2/0G, 2/0J, 1/0F, 1N, 2P, 7 No. 6
Galvanized Steel 	3/16"	7/32", 1/4"	9/32", 5/16"	11/32", 3/8"	7/16"	1/2"
Solid: AL or CU 	4, 5, 6	2, 3	1/0, 1	2/0	3/0	4/0

Use TAP Number

600446\*

600447\*

600448\*











600411\*

600458\*











600459\*

\*UL Listed

## Aluminum Taps

Large Wire Groove Code	G	F	T	K	H	L
ACSR Standard Round 	4/0 <sup>6</sup> / <sub>1</sub>	4/0 <sup>6</sup> / <sub>1</sub>	4/0 <sup>6</sup> / <sub>1</sub>	4/0 <sup>6</sup> / <sub>1</sub>	4/0 <sup>6</sup> / <sub>1</sub>	4/0 <sup>6</sup> / <sub>1</sub>
AAAC 6201 - 5003 	4/0	4/0	4/0	4/0	4/0	4/0
AAAC Standard Round 	4/0	4/0	4/0	4/0	4/0	4/0
COPPER Standard Round 	4/0	4/0	4/0	4/0	4/0	4/0
AAAC Compressed or Compacted 	4/0, 250.0, 266.8	4/0, 250.0, 266.8	4/0, 250.0, 266.8	4/0, 250.0, 266.8	4/0, 250.0, 266.8	4/0, 250.0, 266.8
ACSR Compressed or Compacted 	4/0 <sup>6</sup> / <sub>1</sub> , 266.8 <sup>18</sup> / <sub>1</sub>	4/0 <sup>6</sup> / <sub>1</sub> , 266.8 <sup>18</sup> / <sub>1</sub>	4/0 <sup>6</sup> / <sub>1</sub> , 266.8 <sup>18</sup> / <sub>1</sub>	4/0 <sup>6</sup> / <sub>1</sub> , 266.8 <sup>18</sup> / <sub>1</sub>	4/0 <sup>6</sup> / <sub>1</sub> , 266.8 <sup>18</sup> / <sub>1</sub>	4/0 <sup>6</sup> / <sub>1</sub> , 266.8 <sup>18</sup> / <sub>1</sub>
AWAC, ACAR 	1/0 <sup>2</sup> / <sub>5</sub> , 2/0 <sup>3</sup> / <sub>4</sub> , 3/0 <sup>5</sup> / <sub>2</sub> , 4/3, 4/0 <sup>6</sup> / <sub>1</sub>	1/0 <sup>2</sup> / <sub>5</sub> , 2/0 <sup>3</sup> / <sub>4</sub> , 3/0 <sup>5</sup> / <sub>2</sub> , 4/3, 4/0 <sup>6</sup> / <sub>1</sub>	1/0 <sup>2</sup> / <sub>5</sub> , 2/0 <sup>3</sup> / <sub>4</sub> , 3/0 <sup>5</sup> / <sub>2</sub> , 4/3, 4/0 <sup>6</sup> / <sub>1</sub>	1/0 <sup>2</sup> / <sub>5</sub> , 2/0 <sup>3</sup> / <sub>4</sub> , 3/0 <sup>5</sup> / <sub>2</sub> , 4/3, 4/0 <sup>6</sup> / <sub>1</sub>	1/0 <sup>2</sup> / <sub>5</sub> , 2/0 <sup>3</sup> / <sub>4</sub> , 3/0 <sup>5</sup> / <sub>2</sub> , 4/3, 4/0 <sup>6</sup> / <sub>1</sub>	1/0 <sup>2</sup> / <sub>5</sub> , 2/0 <sup>3</sup> / <sub>4</sub> , 3/0 <sup>5</sup> / <sub>2</sub> , 4/3, 4/0 <sup>6</sup> / <sub>1</sub>
ALUMOWELD 	1/0K, 2/0K, 4/0F, 7 No. 5, 19 No. 10	1/0K, 2/0K, 4/0F, 7 No. 5, 19 No. 10	1/0K, 2/0K, 4/0F, 7 No. 5, 19 No. 10	1/0K, 2/0K, 4/0F, 7 No. 5, 19 No. 10	1/0K, 2/0K, 4/0F, 7 No. 5, 19 No. 10	1/0K, 2/0K, 4/0F, 7 No. 5, 19 No. 10
COPPERWELD						
Galvanized Steel 	9/16"	9/16"	9/16"	9/16"	9/16"	9/16"
Solid: AL or CU 	4/0, 250.0, 266.8, 300.0	4/0, 250.0, 266.8, 300.0	250.0, 266.8, 300.0	250.0, 266.8, 300.0	250.0, 266.8, 300.0	250.0, 266.8, 300.0













ACSR Standard Round 	6 <sup>6</sup> / <sub>1</sub>	4 <sup>6</sup> / <sub>1</sub> , 7 <sup>7</sup> / <sub>1</sub> , 5 <sup>5</sup> / <sub>1</sub>	2 <sup>6</sup> / <sub>1</sub> , 7 <sup>7</sup> / <sub>1</sub> , 3 <sup>3</sup> / <sub>1</sub>	1/0, 1 <sup>6</sup> / <sub>1</sub>	2/0 <sup>6</sup> / <sub>1</sub>	3/0 <sup>6</sup> / <sub>1</sub>
AAAC 6201 - 5003 	6	4, 5	2, 3	1/0, 1	2/0	3/0
AAAC Standard Round 	6	4, 5	2, 3	1/0, 1	2/0	3/0
COPPER Standard Round 	6	4, 5	2, 3	1/0, 1	2/0	3/0
AAAC Compressed or Compacted 	6	3, 4	1, 2	1/0	2/0	3/0
ACSR Compressed or Compacted 	6 <sup>6</sup> / <sub>1</sub>	4 <sup>6</sup> / <sub>1</sub> , 7 <sup>7</sup> / <sub>1</sub>	2 <sup>6</sup> / <sub>1</sub> , 7 <sup>7</sup> / <sub>1</sub>	1/0, 1 <sup>6</sup> / <sub>1</sub>	2/0 <sup>6</sup> / <sub>1</sub>	3/0 <sup>6</sup> / <sub>1</sub>
AWAC, ACAR 	-	4 <sup>6</sup> / <sub>1</sub>	2 <sup>6</sup> / <sub>1</sub> , 3 <sup>6</sup> / <sub>1</sub> , 5 <sup>5</sup> / <sub>2</sub> , 4 <sup>4</sup> / <sub>3</sub> , 4 <sup>5</sup> / <sub>2</sub> , 4 <sup>4</sup> / <sub>3</sub> , 3 <sup>3</sup> / <sub>4</sub>	1/0 <sup>6</sup> / <sub>1</sub> , 1 <sup>6</sup> / <sub>1</sub> , 5 <sup>5</sup> / <sub>2</sub> , 4 <sup>4</sup> / <sub>3</sub> , 2 <sup>2</sup> / <sub>5</sub> , 4 <sup>4</sup> / <sub>3</sub> , 3 <sup>3</sup> / <sub>4</sub> , 2 <sup>2</sup> / <sub>5</sub> , 4 <sup>4</sup> / <sub>3</sub> , 2 <sup>2</sup> / <sub>5</sub>	2 <sup>2</sup> / <sub>5</sub> , 1 <sup>3</sup> / <sub>4</sub> , 1/0 <sup>5</sup> / <sub>2</sub> , 4 <sup>4</sup> / <sub>3</sub> , 2/0 <sup>6</sup> / <sub>1</sub>	1 <sup>2</sup> / <sub>5</sub> , 1/0 <sup>3</sup> / <sub>4</sub> , 2/0 <sup>5</sup> / <sub>2</sub> , 4 <sup>4</sup> / <sub>3</sub> , 3/0 <sup>6</sup> / <sub>1</sub>
ALUMOWELD 				1/0F, 1F, 1G, 1J, 2A, 2G, 2J, 2K, 3A, 4D, 4N, 4P, 3 No. 5, 7 No. 8, 3 No. 6, 7 No. 9	2N, 1K, 1/0G, 1/0J, 2/0F, 7 No.7	2P, 1N, 1/0F, 2/0J, 3/0F, 7 No. 6
COPPERWELD	8A, 8C, 3 No.12	6A, 6C, 7A, 7D, 8D, 3 No.9, 3 No.10, 7 No.12	2F, 4A, 5A, 5D, 6D, 3 No. 7, 3 No. 8, 7 No. 10, 7 No. 11			
Galvanized Steel 	3/16"	7/32", 1/4"	9/32", 5/16"	11/32", 3/8"	7/16"	1/2"
Solid: AL or CU 	4, 5, 6	2, 3, 4	1/0, 1	2/0	3/0	4/0









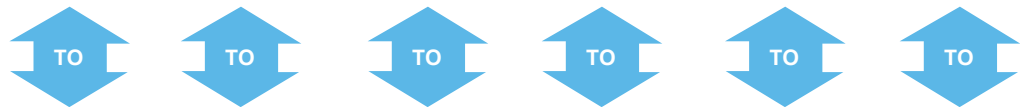

Use TAP Number	600455*	600456*	600411*	600458*	600459*	600465*
----------------	---------	---------	---------	---------	---------	---------

\*UL Listed



Large Wire Groove Code	M	1	2	3	4	5
ACSR Standard Round 	4/0 <sup>6</sup> / <sub>1</sub>	266.8 <sup>6</sup> / <sub>7</sub> , 1 <sup>18</sup> / <sub>1</sub> , 2 <sup>24</sup> / <sub>7</sub> , 2 <sup>6</sup> / <sub>7</sub>	266.8 <sup>6</sup> / <sub>7</sub> , 1 <sup>18</sup> / <sub>1</sub> , 2 <sup>24</sup> / <sub>7</sub> , 2 <sup>6</sup> / <sub>7</sub>	266.8 <sup>6</sup> / <sub>7</sub> , 1 <sup>18</sup> / <sub>1</sub> , 2 <sup>24</sup> / <sub>7</sub> , 2 <sup>6</sup> / <sub>7</sub>	266.8 <sup>6</sup> / <sub>7</sub> , 1 <sup>18</sup> / <sub>1</sub> , 2 <sup>24</sup> / <sub>7</sub> , 2 <sup>6</sup> / <sub>7</sub>	266.8 <sup>6</sup> / <sub>7</sub> , 1 <sup>18</sup> / <sub>1</sub> , 2 <sup>24</sup> / <sub>7</sub> , 2 <sup>6</sup> / <sub>7</sub>
AAAC 6201 - 5003 	4/0	281.4, 307.1, 312.8	281.4, 307.1, 312.8	281.4, 307.1, 312.8	281.4, 307.1, 312.8	281.4, 307.1, 312.8
AAC Standard Round 	4/0	250.0, 266.8, 300.0	250.0, 266.8, 300.0	250.0, 266.8, 300.0	250.0, 266.8, 300.0	250.0, 266.8, 300.0
COPPER Standard Round 	4/0	250.0, 300.0	250.0, 300.0	250.0, 300.0	250.0, 300.0	250.0, 300.0
AAC Compressed or Compacted 	4/0, 250.0, 266.8	300.0, 336.4, 350.0	300.0, 336.4, 350.0	300.0, 336.4, 350.0	300.0, 336.4, 350.0	300.0, 336.4, 350.0
ACSR Compressed or Compacted 	4/0 <sup>6</sup> / <sub>1</sub> , 266.8 <sup>18</sup> / <sub>1</sub>	266.8, 336.4 <sup>18</sup> / <sub>1</sub>	266.8, 336.4 <sup>18</sup> / <sub>1</sub>	266.8, 336.4 <sup>18</sup> / <sub>1</sub>	266.8, 336.4 <sup>18</sup> / <sub>1</sub>	266.8, 336.4 <sup>18</sup> / <sub>1</sub>
AWAC, ACAR 	1/0 <sup>2</sup> / <sub>5</sub> , 2/0 <sup>3</sup> / <sub>4</sub> , 3/0 <sup>5</sup> / <sub>2</sub> , 4 <sup>4</sup> / <sub>3</sub> , 4/0 <sup>6</sup> / <sub>1</sub>	4/0 <sup>15</sup> / <sub>4</sub>	4/0 <sup>15</sup> / <sub>4</sub>	4/0 <sup>15</sup> / <sub>4</sub>	4/0 <sup>15</sup> / <sub>4</sub>	4/0 <sup>15</sup> / <sub>4</sub>
ALUMOWELD 	1/0K, 2/0K, 4/0F, 7 No. 5, 19 No. 10	4/0E, 4/0G, 7 No. 4, 19 No.8, 19 No.9	4/0E, 4/0G, 7 No. 4, 19 No.8, 19 No.9	4/0E, 4/0G, 7 No. 4, 19 No.8, 19 No.9	4/0E, 4/0G, 7 No. 4, 19 No.8, 19 No.9	4/0E, 4/0G, 7 No. 4, 19 No.8, 19 No.9
COPPERWELD						
Galvanized Steel 	9/16"	5/8"	5/8"	5/8"	5/8"	5/8"
Solid: AL or CU 	250.0, 266.8, 300.0	336.4, 350.0, 397.5, 400.0	336.4, 350.0, 397.5, 400.0	336.4, 350.0, 397.5, 400.0	336.4, 350.0, 397.5, 400.0	336.4, 350.0, 397.5, 400.0













ACSR Standard Round 	4/0 <sup>6</sup> / <sub>1</sub>	6 <sup>6</sup> / <sub>1</sub>	4 <sup>6</sup> / <sub>1</sub> , 7 <sup>1</sup> / <sub>1</sub> , 5 <sup>6</sup> / <sub>1</sub>	2 <sup>6</sup> / <sub>1</sub> , 7 <sup>1</sup> / <sub>1</sub> , 3 <sup>6</sup> / <sub>1</sub>	1/0, 1 <sup>6</sup> / <sub>1</sub>	2/0 <sup>6</sup> / <sub>1</sub>
AAAC 6201 - 5003 	4/0	6	4, 5	2, 3	1/0, 1	2/0
AAC Standard Round 	4/0	6	4, 5	1, 2, 3	1/0	2/0
COPPER Standard Round 	4/0	6	4, 5	1, 2, 3	1/0	2/0
AAC Compressed or Compacted 	4/0, 250.0, 266.8	6	3, 4	1, 2	1/0, 2/0	3/0
ACSR Compressed or Compacted 	4/0 <sup>6</sup> / <sub>1</sub> , 266.8	6 <sup>6</sup> / <sub>1</sub>	4 <sup>6</sup> / <sub>1</sub> , 7 <sup>1</sup> / <sub>1</sub>	1 <sup>6</sup> / <sub>1</sub> , 2 <sup>6</sup> / <sub>1</sub> , 7 <sup>1</sup> / <sub>1</sub>	1/0, 2/0 <sup>6</sup> / <sub>1</sub>	3/0 <sup>6</sup> / <sub>1</sub>
AWAC, ACAR 	1/0 <sup>2</sup> / <sub>5</sub> , 2/0 <sup>3</sup> / <sub>4</sub> , 3/0 <sup>5</sup> / <sub>2</sub> , 4 <sup>4</sup> / <sub>3</sub> , 4/0 <sup>6</sup> / <sub>1</sub>	-	4 <sup>6</sup> / <sub>1</sub>	2 <sup>6</sup> / <sub>1</sub> , 5 <sup>2</sup> / <sub>2</sub> , 3 <sup>6</sup> / <sub>1</sub> , 5 <sup>2</sup> / <sub>2</sub> , 4 <sup>3</sup> / <sub>3</sub> , 4 <sup>4</sup> / <sub>3</sub> , 3 <sup>4</sup> / <sub>4</sub> , 5 <sup>2</sup> / <sub>2</sub>	4 <sup>2</sup> / <sub>5</sub> , 3 <sup>3</sup> / <sub>4</sub> , 2 <sup>2</sup> / <sub>5</sub> , 2 <sup>4</sup> / <sub>3</sub> , 3 <sup>4</sup> / <sub>4</sub> , 1 <sup>6</sup> / <sub>1</sub> , 5 <sup>2</sup> / <sub>2</sub> , 4 <sup>3</sup> / <sub>3</sub> , 1/0 <sup>6</sup> / <sub>1</sub>	2 <sup>2</sup> / <sub>5</sub> , 1 <sup>3</sup> / <sub>4</sub> , 1/0 <sup>5</sup> / <sub>2</sub> , 4 <sup>3</sup> / <sub>3</sub> , 2/0 <sup>6</sup> / <sub>1</sub>
ALUMOWELD 	1/0K, 2/0K, 4/0F, 7 No. 5, 19 No. 10	8A, 8C, 3 No. 12	5A, 6A, 6C, 7A, 7D, 8D, 3 No.9, 3 No.10, 7 No.12	2F, 2G 3A, 4A, 4N, 5D, 6D, 3 No. 7, 3 No. 8, 7 No. 10, 7 No. 11	1/0F, 1F, 1G, 1J, 2A, 2J, 2K, 4D, 4P, 3 No. 5, 7 No. 8, 3 No. 6, 7 No. 9	1K, 1/0G, 1/0J, 2N, 2P, 2/0F, 7 No. 7
COPPERWELD						
Galvanized Steel 	9/16"	3/16"	7/32", 1/4"	9/32", 5/16"	11/32", 3/8"	7/16"
Solid: AL or CU 	250.0, 266.8, 300.0	4, 5, 6	2, 3	1/0, 1	2/0, 3/0	4/0









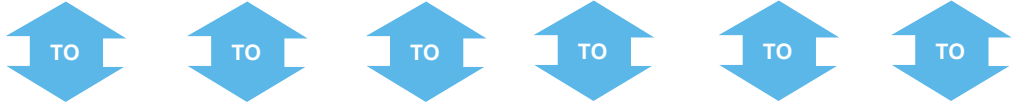

Use TAP Number	600466*	602046-1*	602046-2*	602046-3*	602046-4*	602046-5*
----------------	---------	-----------	-----------	-----------	-----------	-----------

\*UL Listed

Aluminum Taps

Large Wire Groove Code	6	7	9	19	18	17
ACSR Standard Round 	266.8 <sup>6/7, 18/1, 24/7, 26/7</sup>	266.8 <sup>6/7, 18/1, 24/7, 26/7</sup>	266.8 <sup>6/7, 18/1, 24/7, 26/7</sup>	266.8 <sup>6/7, 18/1, 24/7, 26/7, 30/7</sup> , 300.0 <sup>18/1, 24/7, 26/7, 336.4<sup>18/1</sup></sup>	266.8 <sup>6/7, 18/1, 24/7, 26/7, 30/7</sup> , 300.0 <sup>18/1, 24/7, 26/7, 336.4<sup>18/1</sup></sup>	266.8 <sup>6/7, 18/1, 24/7, 26/7, 30/7</sup> , 300.0 <sup>18/1, 24/7, 26/7, 336.4<sup>18/1</sup></sup>
AAAC 6201 - 5003 	281.4, 307.1, 312.8	281.4, 307.1, 312.8	281.4, 307.1, 312.8	281.4, 307.1, 312.8, 355.1	281.4, 307.1, 312.8, 355.1	281.4, 307.1, 312.8, 355.1
AAC Standard Round 	250.0, 266.8, 300.0	250.0, 266.8, 300.0	250.0, 266.8, 300.0	300.0, 336.4, 350.0	300.0, 336.4, 350.0	300.0, 336.4, 350.0
COPPER Standard Round 	250.0, 300.0	250.0, 300.0	250.0, 300.0	250.0, 300.0, 350.0	250.0, 300.0, 350.0	250.0, 300.0, 350.0
AAC Compressed or Compacted 	300.0, 336.4, 350.0	300.0, 336.4, 350.0	300.0, 336.4, 350.0	336.4, 350.0, 397.5	336.4, 350.0, 397.5	336.4, 350.0, 397.5
ACSR Compressed or Compacted 	266.8, 336.4 <sup>18/1</sup>	266.8, 336.4 <sup>18/1</sup>	336.4 <sup>18/1</sup>	336.4, 397.5 <sup>18/1</sup>	336.4, 397.5 <sup>18/1</sup>	336.4, 397.5 <sup>18/1</sup>
AWAC, ACAR 	4/0 <sup>15/4</sup>	4/0 <sup>15/4</sup>	4/0 <sup>15/4</sup>	336.4 <sup>18/1, 343.6<sup>15/4, 355.0<sup>15/4, 12/7</sup></sup></sup>	336.4 <sup>18/1, 343.6<sup>15/4, 355.0<sup>15/4, 12/7</sup></sup></sup>	336.4 <sup>18/1, 343.6<sup>15/4, 355.0<sup>15/4, 12/7</sup></sup></sup>
ALUMOWELD 	4/0E, 4/0G, 7 No. 4, 19 No.8, 19 No.9	4/0E, 4/0G, 7 No.4, 19 No.8, 19 No.9	4/0E, 4/0G, 7 No. 4, 19 No.8, 19 No.9	4/0E, 7 No. 4, 19 No. 8	4/0E, 7 No. 4, 19 No. 8	4/0E, 7 No. 4, 19 No. 8
COPPERWELD 						
Galvanized Steel 	5/8"	5/8"	5/8"	5/8"	5/8"	5/8"
Solid: AL or CU 	336.4, 350.0, 397.5, 400.0	336.4, 350.0, 397.5, 400.0	336.4, 350.0, 397.5, 400.0	397.5, 400.0, 450.0	397.5, 400.0, 450.0	397.5, 400.0, 450.0













ACSR Standard Round 	3/0 <sup>6/1</sup>	4/0 <sup>6/1</sup>	266.8 <sup>6/7, 18/1, 24/7, 26/7</sup>	6 <sup>6/1</sup>	4 <sup>6/1, 7/1, 5<sup>6/1</sup></sup>	2 <sup>6/1, 7/1, 3<sup>6/1</sup></sup>
AAAC 6201 - 5003 	3/0	4/0	281.4, 307.1, 312.8	6	4, 5	2, 3
AAC Standard Round 	3/0	4/0, 250.0	266.8, 300.0	6	4, 5	1, 2, 3
COPPER Standard Round 	3/0	4/0, 250.0	300.0	6	4, 5	1, 2, 3
AAC Compressed or Compacted 	4/0, 250.0	266.8, 300.0	336.4, 350.0	6	3, 4	1, 2
ACSR Compressed or Compacted 	4/0 <sup>6/1</sup>	266.8 <sup>18/1</sup>	336.4 <sup>18/1</sup>	6 <sup>6/1</sup>	4 <sup>6/1, 7/1</sup>	1 <sup>6/1, 2<sup>6/1, 7/1</sup></sup>
AWAC, ACAR 	1 <sup>2/5, 1/0<sup>3/4, 2/0<sup>5/2, 4/3, 3/0<sup>6/1</sup></sup></sup></sup>	1/0 <sup>2/5, 2/0<sup>3/4, 3/0<sup>5/2, 4/3, 4/0<sup>6/1, 15/4</sup></sup></sup></sup>	-	-	4 <sup>6/1</sup>	2 <sup>6/1, 5/2, 3<sup>6/1, 5/2, 4/3, 4<sup>4/3, 3/4, 5/2</sup></sup></sup>
ALUMOWELD 	1N, 1/0K, 2/0G, 2/0J, 3/0F, 7 No. 6, 19 No. 10	2/0K, 4/0F, 7 No. 6, 19 No. 10	4/0E, 4/0G, 7 No. 4, 19 No.8	8A, 8C, 3 No. 12	5A, 6A, 6C, 7A, 7D, 8D, 3 No. 9, 3 No.10, 7 No. 12	2F, 2G, 3A, 4A, 4N, 5D, 6D, 3 No. 7, 3 No. 8, 7 No. 10, 7 No. 11
COPPERWELD 						
Galvanized Steel 	1/2"	9/16"	5/8"	3/16"	7/32", 1/4"	9/32", 5/16"
Solid: AL or CU 	250.0, 266.8	300.0	336.4, 350.0, 397.5, 400.0	4, 5, 6	2, 3	1/0, 1









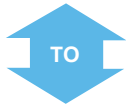
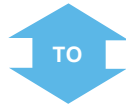

Use TAP Number	602046-6*	602046-7*	602046-9*	602380*	602380-1*	602380-2*
----------------	-----------	-----------	-----------	---------	-----------	-----------

\*UL Listed

## Aluminum Taps

Large Wire Groove Code	5	6	7	9	16
ACSR Standard Round 	266.8 <sup>6/7, 18/1, 24/7, 26/7, 30/7</sup> , 300.0 <sup>18/1, 24/7, 26/7, 336.4<sup>18/1</sup></sup>	266.8 <sup>6/7, 18/1, 24/7, 26/7, 30/7</sup> , 300.0 <sup>18/1, 24/7, 26/7, 336.4<sup>18/1</sup></sup>	266.8 <sup>6/7, 18/1, 24/7, 26/7, 30/7</sup> , 300.0 <sup>18/1, 24/7, 26/7, 336.4<sup>18/1</sup></sup>	266.8 <sup>6/7, 18/1, 24/7, 24/7, 30/7</sup> , 300.0 <sup>18/1, 24/7, 26/7, 336.4<sup>18/1</sup></sup>	266.8 <sup>6/7, 18/1, 24/7, 26/7, 30/7</sup> , 300.0 <sup>18/1, 24/7, 26/7, 336.4<sup>18/1</sup></sup>
AAAC 6201 - 5003 	281.4, 307.1, 312.8, 355.1	281.4, 307.1, 312.8, 355.1	281.4, 307.1, 312.8, 355.1	281.4, 307.1, 312.8, 355.1	281.4, 307.1, 312.8, 355.1
AAC Standard Round 	300.0, 336.4, 350.0	300.0, 336.4, 350.0	300.0, 336.4, 350.0	300.0, 336.4, 350.0	300.0, 336.4, 350.0
COPPER Standard Round 	250.0, 300.0, 350.0	250.0, 300.0, 350.0	250.0, 300.0, 350.0	250.0, 300.0, 350.0	250.0, 300.0, 350.0
AAC Compressed or Compacted 	336.4, 350.0, 397.5	336.4, 350.0, 397.5	336.4, 350.0, 397.5	336.4, 350.0, 397.5	336.4, 350.0, 397.5
ACSR Compressed or Compacted 	336.4, 397.5 <sup>18/1</sup>	336.4, 397.5 <sup>18/1</sup>	336.4, 397.5 <sup>18/1</sup>	336.4, 397.5 <sup>18/1</sup>	336.4, 397.5 <sup>18/1</sup>
AWAC, ACAR 	336.4 <sup>18/1</sup> , 343.6 <sup>15/4</sup> , 355.0 <sup>15/4, 12/7</sup>	336.4 <sup>18/1</sup> , 343.6 <sup>15/4</sup> , 355.0 <sup>15/4, 12/7</sup>	336.4 <sup>18/1</sup> , 343.6 <sup>15/4</sup> , 355.0 <sup>15/4, 12/7</sup>	336.4 <sup>18/1</sup> , 343.6 <sup>15/4</sup> , 355.0 <sup>15/4, 12/7</sup>	336.4 <sup>18/1</sup> , 343.6 <sup>15/4</sup> , 355.0 <sup>15/4, 12/7</sup>
ALUMOWELD COPPERWELD 	4/0 E, 7 No. 4, 19 No. 8	4/0E, 7 No. 4, 19 No. 8	4/0E, 7 No. 4, 19 No. 8	4/0E, 7 No. 4, 19 No. 8	4/0 E, 7 No. 4, 19 No. 8
Galvanized Steel 	5/8"	5/8"	5/8"	5/8"	5/8"
Solid: AL or CU 	397.5, 400.0, 450.0	397.5, 400.0, 450.0	397.5, 400.0, 450.0	397.5, 400.0, 450.0	397.5, 400.0, 450.0



















ACSR Standard Round 	1/0, 1 <sup>6/1</sup>	2/0 <sup>6/1</sup>	3/0 <sup>6/1</sup>	4/0 <sup>6/1</sup>	266.8 <sup>6/7, 18/1, 24/7, 26/7, 30/7</sup> , 300.0 <sup>18/1, 24/7, 26/7, 336.4<sup>18/1</sup></sup>
AAAC 6201 - 5003 	1/0, 1	2/0	3/0	4/0	281.4, 307.1, 312.8, 355.1
AAC Standard Round 	1/0	2/0	3/0	4/0, 250.0, 266.8	300.0, 336.4, 350.0
COPPER Standard Round 	1/0	2/0	3/0	4/0, 250.0	—
AAC Compressed or Compacted 	1/0, 2/0	3/0	4/0, 250.0	266.8, 300.0	336.4, 350.0
ACSR Compressed or Compacted 	1/0, 2/0 <sup>6/1</sup>	3/0 <sup>6/1</sup>	4/0 <sup>6/1</sup>	266.8 <sup>18/1</sup>	336.4 <sup>18/1</sup>
AWAC, ACAR 	4 <sup>2/5</sup> , 3 <sup>3/4</sup> , 2 <sup>5/8</sup> , 2 <sup>4/3</sup> , 3 <sup>1/4</sup> , 1 <sup>6/1</sup> , 5 <sup>1/2</sup> , 4 <sup>1/3</sup> , 1/0 <sup>6/1</sup>	2 <sup>2/5</sup> , 1 <sup>3/4</sup> , 1/0 <sup>5/2</sup> , 4 <sup>1/3</sup> , 2/0 <sup>6/1</sup>	1 <sup>2/5</sup> , 1/0 <sup>3/4</sup> , 2/0 <sup>5/2</sup> , 4 <sup>1/3</sup> , 3/0 <sup>6/1</sup>	1/0 <sup>2/5</sup> , 2/0 <sup>3/4</sup> , 3/0 <sup>5/2</sup> , 4 <sup>1/3</sup> , 4/0 <sup>6/1, 15/4</sup>	336.4 <sup>18/1</sup> , 343.6 <sup>15/4</sup> , 350.0 <sup>15/4, 12/7</sup>
ALUMOWELD COPPERWELD 	1/0F, 1F, 1G, 1J, 2A, 2J, 2K, 4D, 4P, 3 No. 5, 3 No. 6, 7 No. 8, 7 No.9	1K, 1/0G, 1/0J, 2N, 2P, 2/0F, 7 No.7	1N, 1/0K, 2/0G, 2/0J, 3/0F, 7 No. 6, 19 No. 10	2/0K, 4/0F, 4/0G, 7 No. 5, 19 No. 9	4/0E, 7 No.4, 19 No.8
Galvanized Steel 	1 <sup>1/32</sup> ", 3/8"	7/16"	1/2"	9/16"	5/8"
Solid: AL or CU 	2/0, 3/0	4/0	250.0, 266.8	350.0, 336.4, 300.0	—









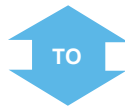

Use TAP Number      602380-3\*      602380-4\*      602380-5\*      602380-6\*      602380-7\*

\*UL Listed

## Aluminum Taps

Large Wire Groove Code						
ACSR Standard Round 	336.4 <sup>18/1, 24/7, 26/7, 266.8<sup>30/7</sup></sup> 300.0 <sup>18/1 24/7, 26/7, 30/7</sup>	336.4 <sup>18/1, 24/7, 26/7, 266.8<sup>30/7</sup></sup> 300.0 <sup>18/1 24/7, 26/7, 30/7</sup>	336.4 <sup>18/1, 24/7, 26/7, 266.8<sup>30/7</sup></sup> 300.0 <sup>18/1 24/7, 26/7, 30/7</sup>	336.4 <sup>18/1, 24/7, 26/7, 266.8<sup>30/7</sup></sup> 300.0 <sup>18/1 24/7, 26/7, 30/7</sup>	336.4 <sup>18/1, 24/7, 26/7, 266.8<sup>30/7</sup></sup> 300.0 <sup>18/1 24/7, 26/7, 30/7</sup>	336.4 <sup>18/1, 24/7, 26/7, 266.8<sup>30/7</sup></sup> 300.0 <sup>18/1 24/7, 26/7, 30/7</sup>
AAAC 6201 - 5003 	355.1	355.1	355.1	355.1	355.1	355.1
AAC Standard Round 	336.4, 350.0 397.5, 400.0	336.4, 350.0 397.5, 400.0	336.4, 350.0 397.5, 400.0	336.4, 350.0 397.5, 400.0	336.4, 350.0 397.5, 400.0	336.4, 350.0 397.5, 400.0
COPPER Standard Round 	350.0, 400.0	350.0, 400.0	350.0, 400.0	350.0, 400.0	350.0, 400.0	350.0, 400.0
AAC Compressed or Compacted 	336.4, 350.0, 397.5	336.4, 350.0, 397.5	336.4, 350.0, 397.5	336.4, 350.0, 397.5	336.4, 350.0, 397.5	336.4, 350.0, 397.5
ACSR Compressed or Compacted 	336.4, 397.5 <sup>18/1</sup>	336.4, 397.5 <sup>18/1</sup>	336.4, 397.5 <sup>18/1</sup>	336.4, 397.5 <sup>18/1</sup>	336.4, 397.5 <sup>18/1</sup>	336.4, 397.5 <sup>18/1</sup>
AWAC, ACAR 	336.4 <sup>18/1, 16/3, 15/4, 343.6<sup>15/4</sup></sup> 355.0 <sup>15/4, 12/7</sup>	336.4 <sup>18/1, 16/3, 15/4, 343.6<sup>15/4</sup></sup> 355.0 <sup>15/4, 12/7</sup>	336.4 <sup>18/1, 16/3, 15/4, 343.6<sup>15/4</sup></sup> 355.0 <sup>15/4, 12/7</sup>	336.4 <sup>18/1, 16/3, 15/4, 343.6<sup>15/4</sup></sup> 355.0 <sup>15/4, 12/7</sup>	336.4 <sup>18/1, 16/3, 15/4, 343.6<sup>15/4</sup></sup> 355.0 <sup>15/4, 12/7</sup>	336.4 <sup>18/1, 16/3, 15/4, 343.6<sup>15/4</sup></sup> 355.0 <sup>15/4, 12/7</sup>
ALUMOWELD COPPERWELD 	4/0 E, 19 No. 7, 19 No. 8, 7 No. 4, 37 No.10	4/0 E, 19 No. 7, 19 No. 8, 7 No. 4, 37 No.10	4/0 E, 19 No. 7, 19 No. 8, 7 No. 4, 37 No.10	4/0 E, 19 No. 7, 19 No. 8, 7 No. 4, 37 No.10	4/0E, 19 No. 7, 19 No. 8, 7 No. 4, 37 No.10	4/0E, 19 No. 7, 19 No. 8, 7 No. 4, 37 No.10
Galvanized Steel 	5/8"	5/8"	5/8"	5/8"	5/8"	5/8"
Solid: AL or CU 	450.0, 477.0, 500.0	450.0, 477.0, 500.0	450.0, 477.0, 500.0	450.0, 477.0, 500.0	450.0, 477.0, 500.0	450.0, 477.0, 500.0



ACSR Standard Round 	6/1	4 <sup>6/1, 7/1, 5<sup>6/1</sup></sup>	2 <sup>1/6, 7/1, 3<sup>6/1</sup></sup>	1/0 <sup>1/6, 1<sup>6/1</sup></sup>	2/0 <sup>6/1</sup>	3/0 <sup>6/1</sup>
AAAC 6201 - 5003 	6	4, 5	2, 3	1/0, 1	2/0	3/0
AAC Standard Round 	6	4, 5	2, 3	1/0, 1	2/0	3/0
COPPER Standard Round 	6	4, 5	2, 3	1/0, 1	2/0	3/0
AAC Compressed or Compacted 	6	3, 4	1, 2	1/0	2/0	3/0, 4/0
ACSR Compressed or Compacted 	6 <sup>6/1</sup>	4 <sup>6/1, 7/1</sup>	2 <sup>6/1, 7/1</sup>	1/0, 1 <sup>6/1</sup>	2/0 <sup>6/1</sup>	3/0 <sup>6/1</sup>
AWAC, ACAR 	-	4 <sup>6/1</sup>	2 <sup>6/1, 3<sup>6/1, 5/2, 4/3, 4<sup>5/2, 4/3, 3/4</sup></sup></sup>	1/0 <sup>1/6, 1<sup>6/1, 5/2, 4/3, 2<sup>5/2, 4/3, 3/4, 3<sup>3/4, 2/5, 4<sup>2/5</sup></sup></sup></sup></sup>	2 <sup>2/5, 1<sup>3/4, 1/0<sup>5/2, 4/3, 2/0<sup>6/1, 4/3</sup></sup></sup></sup>	1 <sup>2/5, 1/0<sup>3/4, 2/0<sup>5/2, 3/0<sup>6/1</sup></sup></sup></sup>
ALUMOWELD COPPERWELD 	8A, 8C, 3 No. 12	6A, 6C, 7A, 7D, 8D, 3 No. 9, 3 No. 10, 7 No. 10	2F, 4A, 5A, 5D, 6D, 3 No. 7, 3 No. 8, 7 No. 10, 7 No. 11	1/0F, 1F, 1G, 1J, 2A, 2G, 2J, 2K, 3A, 4D, 4N, 4P, 3 No. 5, 3 No. 6, 7 No. 8, 7 No.9	2N, 1K, 1/0G, 1/0J, 2/0F, 7 No.7, 1/0F	2P, 1N, 2/0G, 2/0J, 3/0F, 7 No. 6
Galvanized Steel 	3/16"	7/32", 1/4"	9/32", 5/16"	11/32", 3/0"	7/16"	1/2"
Solid: AL or CU 	4, 5, 6	2, 3, 4	1/0, 1, 2	1/0, 2/0	2/0, 3/0	4/0

Use TAP Number	602014*	602013*	602000*	602001*	602002*	602003*
----------------	---------	---------	---------	---------	---------	---------

\*UL Listed

## Aluminum Taps

Large Wire Groove Code							
ACSR Standard Round		336.4 <sup>18/1, 24/7, 26/7</sup> , 266.8 <sup>30/7</sup> , 300.0 <sup>18/1, 24/7, 26/7, 30/7</sup>	336.4 <sup>18/1, 24/7, 26/7</sup> , 266.8 <sup>30/7</sup> , 300.0 <sup>18/1, 24/7, 26/7, 30/7</sup>	336.4 <sup>18/1, 24/7, 26/7</sup> , 266.8 <sup>30/7</sup> , 300.0 <sup>18/1, 24/7, 26/7, 30/7</sup>	477.0, 397.5 <sup>18/1, 24/7, 26/7</sup> , 397.5, 336.4 <sup>30/7</sup>	477.0, 397.5 <sup>18/1, 24/7, 26/7</sup> , 397.5, 336.4 <sup>30/7</sup>	477.0, 397.5 <sup>18/1, 24/7, 26/7</sup> , 397.5, 336.4 <sup>30/7</sup>
AAAC 6201 - 5003		355.1	355.1	355.1	419.6, 465.4, 466.3, 503.6, 559.5	419.6, 465.4, 466.3, 503.6, 559.5	419.6, 465.4, 466.3, 503.6, 559.5
AAC Standard Round		336.4, 350.0, 397.5, 400.0	336.4, 350.0, 397.5, 400.0	336.4, 350.0, 397.5, 400.0	450.0, 477.0, 500.0, 550.0, 556.5	450.0, 477.0, 500.0, 550.0, 556.5	450.0, 477.0, 500.0, 550.0, 556.5
COPPER Standard Round		350.0, 400.0	350.0, 400.0	350.0, 400.0	450.0, 500.0, 550.0	450.0, 500.0, 550.0	450.0, 500.0, 550.0
AAC Compressed or Compacted		336.4, 350.0, 397.5	336.4, 350.0, 397.5	336.4, 350.0, 397.5	–	–	–
ACSR Compressed or Compacted		336.4, 397.5 <sup>18/1</sup>	336.4, 397.5 <sup>18/1</sup>	336.4, 397.5 <sup>18/1</sup>	477.0, 556.5	477.0, 556.5	477.0, 556.5
AWAC, ACAR		336.4 <sup>18/1, 16/3, 15/4</sup> , 343.6 <sup>15/4</sup> , 355.0 <sup>15/4, 12/7</sup>	336.4 <sup>18/1, 16/3, 15/4</sup> , 343.6 <sup>15/4</sup> , 355.0 <sup>15/4, 12/7</sup>	336.4 <sup>18/1, 16/3, 15/4</sup> , 343.6 <sup>15/4</sup> , 355.0 <sup>15/4, 12/7</sup>	503.6 <sup>15/4, 12/7</sup>	503.6 <sup>15/4, 12/7</sup>	503.6 <sup>15/4, 12/7</sup>
ALUMOWELD		4/0E, 19 No. 7, 19 No. 8, 7 No. 4, 37 No.10	4/0 E, 19 No. 7, 19 No. 8, 7 No. 4, 37 No.10	4/0E, 19 No. 7, 19 No. 8, 7 No. 4, 37 No.10	19 No. 6, 37 No. 9	19 No. 6, 37 No. 9	19 No. 6, 37 No.9
COPPERWELD		–	–	–	–	–	–
Galvanized Steel		5/8"	5/8"	5/8"	3/4"	3/4"	3/4"
Solid: AL or CU		450.0, 477.0, 500.0	450.0, 477.0, 500.0	450.0, 477.0, 500.0	–	–	–



ACSR Standard Round		4/0 <sup>1/6</sup>	266.8 <sup>6/7, 18/1, 24/7, 26/7</sup> , 4/0 <sup>6/1</sup>	300.0, 336.4 <sup>18/1, 24/7, 26/7</sup> , 266.8, 300.0 <sup>30/7</sup> , 266.8 <sup>6/7</sup>	6 <sup>6/1</sup>	4 <sup>1/6, 7/1</sup> , 5 <sup>6/1</sup>	2 <sup>6/1, 7/1</sup> , 3 <sup>6/1</sup>
AAAC 6201 - 5003		4/0	4/0, 281.4, 307.1, 312.8	355.1, 394.5	6	4, 5	2, 3
AAC Standard Round		4/0	250.0, 266.8, 300.0	336.4, 350.0, 397.5, 400.0	6	4, 5	2, 3
COPPER Standard Round		4/0	250.0, 300.0	350.0, 400.0	6	4, 5	2, 3
AAC Compressed or Compacted		250.0, 266.8	300.0, 336.4, 350.0	397.5	6	3, 4	1, 2
ACSR Compressed or Compacted		4/0 <sup>6/1</sup> , 266.8 <sup>18/1</sup>	266.8 <sup>18/1</sup>	397.5 <sup>18/1</sup>	6 <sup>6/1</sup>	4 <sup>6/1, 7/1</sup>	2 <sup>6/1, 7/1</sup>
AWAC, ACAR		1/0 <sup>2/5, 2/0<sup>3/4, 3/0<sup>5/2, 4/3, 4<sup>6/1</sup></sup></sup></sup>	4/0 <sup>15/4</sup>	336.4 <sup>18/1, 16/3, 15/4</sup> , 355.0 <sup>15/4, 12/7</sup> , 343.6 <sup>15/4</sup>	–	4 <sup>6/1</sup>	2 <sup>6/1, 3<sup>6/1, 5/2, 4/3, 4<sup>5/2, 4/3, 3/4</sup></sup></sup>
ALUMOWELD		2/0K, 4/0F, 7 No. 5, 19 No. 10	4/0G, 7 No.4, 19 No.8, 19 No. 9	19 No. 7, 37 No.10	8A, 8C, 3 No. 12	6A, 6C, 7A, 7D, 8D, 3 No. 9, 3 No. 10, 7 No.12	2F, 4A, 5A, 5D, 6D, 3 No. 7, 3 No. 8, 7 No. 10, 7 No. 11
COPPERWELD		–	–	–	–	–	–
Galvanized Steel		9/16"	9/16", 5/8"	–	3/16"	7/32", 1/4"	9/32", 5/16"
Solid: AL or CU		250.0, 266.8, 300.0	336.4, 350.0, 397.5, 400.0	450.0, 477.0, 500.0	4, 5, 6	2, 3, 4	1/0, 1, 2

Use TAP Number	602004*	602006*	602007*	I-602031-0*	602031-9*	602031-8*
----------------	---------	---------	---------	-------------	-----------	-----------

\*UL Listed

## Aluminum Taps

Large Wire Groove Code						
ACSR Standard Round	477.0 <sup>26/7, 24/7, 18/1</sup> , 336.4 <sup>30/7</sup> , 397.5 <sup>30/7 26/7, 24/7, 18/1</sup>	477.0 <sup>26/7, 24/7, 18/1</sup> , 336.4 <sup>30/7</sup> , 397.5 <sup>30/7 26/7, 24/7, 18/1</sup>	477.0 <sup>26/7, 24/7, 18/1</sup> , 336.4 <sup>30/7</sup> , 397.5 <sup>30/7 26/7, 24/7, 18/1</sup>	477.0 <sup>26/7, 24/7, 18/1</sup> , 336.4 <sup>30/7</sup> , 397.5 <sup>30/7 26/7, 24/7, 18/1</sup>	477.0 <sup>26/7, 24/7, 18/1</sup> , 336.4 <sup>30/7</sup> , 397.5 <sup>30/7 26/7, 24/7, 18/1</sup>	477.0 <sup>26/7, 24/7, 18/1</sup> , 336.4 <sup>30/7</sup> , 397.5 <sup>30/7 26/7, 24/7, 18/1</sup>
AAAC 6201 - 5003	419.5, 466.3, 465.4, 503.6	419.6, 465.4, 466.3, 503.6	419.6, 465.4, 466.3, 503.6	419.5, 466.3, 465.4, 503.6	419.6, 465.4, 466.3, 503.6	419.6, 465.4, 466.3, 503.6
AAC Standard Round	450.0, 477.0, 500.0, 550.0, 556.5	450.0, 477.0, 500.0, 550.0, 556.5	450.0, 477.0, 500.0, 550.0, 556.5	450.0, 477.0, 500.0, 550.0, 556.5	450.0, 477.0, 500.0, 550.0, 556.5	450.0, 477.0, 500.0, 550.0, 556.5
COPPER Standard Round	450.0, 500.0, 550.0	450.0, 500.0, 550.0	450.0, 500.0, 550.0	450.0, 500.0, 550.0	450.0, 500.0, 550.0	450.0, 500.0, 550.0
AAC Compressed or Compacted	–	–	–	–	–	–
ACSR Compressed or Compacted	477.0, 556.5	477.0, 556.5	477.0, 556.5	477.0, 556.5	477.0, 556.5	477.0, 556.5
AWAC, ACAR	503.6 <sup>15/4, 12/7</sup>	503.6 <sup>15/4, 12/7</sup>	503.6 <sup>15/4, 12/7</sup>	503.6 <sup>15/4, 12/7</sup>	503.6 <sup>15/4, 12/7</sup>	503.6 <sup>15/4, 12/7</sup>
ALUMOWELD	19 No. 6,	19 No. 6,	19 No. 6,	19 No. 6,	19 No. 6,	19 No. 6,
COPPERWELD	37 No. 9	37 No.9	37 No.9	37 No. 9	37 No. 9	37 No. 9
Galvanized Steel	3/4"	3/4"	3/4"	3/4"	3/4"	3/4"
Solid: AL or CU	–	–	–	–	–	–



ACSR Standard Round	1/0 <sup>6/1</sup>	2/0 <sup>6/1</sup>	3/0 <sup>6/1</sup>	4/0 <sup>6/1</sup>	266.8 <sup>30/7, 24/7, 6/7, 18/1</sup>	266.8 <sup>26/7, 336.4<sup>26/7, 24/7, 18/1</sup></sup>
AAAC 6201 - 5003	1/0	2/0	3/0	4/0	281.4, 307.1, 312.8	355.1, 394.5
AAC Standard Round	1/0	2/0	3/0	4/0	250.0, 266.8, 300.0	336.4, 350.0, 397.5, 400.0
COPPER Standard Round	1/0	2/0	3/0	4/0	250.0, 300.0	350.0, 400.0
AAC Compressed or Compacted	1/0	2/0	3/0	250.0, 266.8	300.0, 336.4	397.5
ACSR Compressed or Compacted	1/0 <sup>6/1</sup>	2/0 <sup>6/1</sup>	3/0 <sup>6/1</sup>	266.8 <sup>18/1</sup> , 4/0 <sup>6/1</sup>	336.4 <sup>18/1</sup>	397.5
AWAC, ACAR	3 <sup>3/4</sup> , 2 <sup>4/3</sup> , 1 <sup>5/2</sup> , 6/1	2/0 <sup>6/1</sup> , 1/0 <sup>5/2</sup> , 6/1, 1 <sup>3/4</sup> , 4/3, 2 <sup>2/5</sup> , 3/4, 3 <sup>2/5</sup>	3/0 <sup>6/1</sup> , 2/0 <sup>4/3</sup> , 5/2, 1/0 <sup>3/4</sup> , 4/3, 1 <sup>2/5</sup>	4/0 <sup>6/1</sup> , 3/0 <sup>5/2</sup> , 2/0 <sup>3/4</sup> , 1/0 <sup>2/5</sup>	3/0 <sup>4/3</sup> , 4/0 <sup>15/4</sup>	355.0 <sup>15/4, 12/7</sup> , 343.6 <sup>15/4, 336.4<sup>15/4, 16/3, 18/1</sup></sup>
ALUMOWELD	4P, 2K, 2J, 1G,	2/0F, 1/0J,	3/0F, 2/0J, 2/0G,	19 No. 10,	19 No. 8, 19	19 No. 7,
COPPERWELD	1F, 7 No. 9, 3 No. 6	1/0G, 1/0F, 1K, 1J, 2N, 7 No.7, 7 No.8, 3 No.5	1/0K, 1N, 2P, 7 No.6	7 No.5, 4/0 F, 2/0 K	No.9, 7 No.4, 4/0 E, 4/0 G	37 No.10
Galvanized Steel	3/8"	7/16"	1/2"	–	9/16", 5/8"	–
Solid: AL or CU	2/0	3/0	4/0	300.0, 250.0	400.0, 350.0	450.0, 500.0

Use TAP Number	I-602031-9*	I-602031-8*	I-602031-7*	1-602031-6*	I-602031-5*	I-602031-4*
----------------	-------------	-------------	-------------	-------------	-------------	-------------

\*UL Listed

## Aluminum Taps

Large Wire Groove Code						
ACSR Standard Round		477.0 <sup>26/7, 24/7, 18/1, 336.4<sup>30/7, 397.5<sup>30/7, 26/7, 24/7, 18/1</sup></sup></sup>	556.5 <sup>26/7, 24/7, 18/1, 477.0<sup>30/7, 26/7</sup></sup>	556.5 <sup>26/7, 24/7, 18/1, 477.0<sup>30/7, 26/7</sup></sup>	556.5 <sup>26/7, 24/7, 18/1, 477.0<sup>30/7, 26/7</sup></sup>	556.5 <sup>26/7, 24/7, 18/1, 477.0<sup>30/7, 26/7</sup></sup>
AAAC 6201 - 5003		419.6, 465.4, 466.3, 503.6	559.5, 587.2, 599.6, 652.4, 652.8	559.5, 587.2, 599.6, 652.4, 652.8	559.5, 587.2, 599.6, 652.4, 652.8	559.5, 587.2, 599.6, 652.4, 652.8
AAC Standard Round		450.0, 477.0, 500.0, 550.0, 556.5	556.5, 600.0, 636.0	556.5, 600.0, 636.0	556.5, 600.0, 636.0	556.5, 600.0, 636.0
COPPER Standard Round		450.0, 500.0, 550.0	550.0, 600.0	550.0, 600.0	550.0, 600.0	550.0, 600.0
AAC Compressed or Compacted		—	—	—	—	—
ACSR Compressed or Compacted		477.0, 556.5	636.0 <sup>18/1</sup>	636.0 <sup>18/1</sup>	636.0 <sup>18/1</sup>	636.0 <sup>18/1</sup>
AWAC, ACAR		503.6 <sup>15/4, 12/7</sup>	653.1 <sup>15/4, 12/7, 568.3<sup>15/4</sup></sup>	653.1 <sup>15/4, 12/7, 568.3<sup>15/4</sup></sup>	653.1 <sup>15/4, 12/7, 568.3<sup>15/4</sup></sup>	653.1 <sup>15/4, 12/7, 568.3<sup>15/4</sup></sup>
ALUMOWELD COPPERWELD		19 No. 6, 37 No. 9	19 No. 5, 37 No. 8	19 No. 5, 37 No. 8	19 No. 5, 37 No. 8	19 No. 5, 37 No. 8
Galvanized Steel		3/4"	7/8"	7/8"	7/8"	7/8"
Solid: AL or CU		—	—	—	—	—



ACSR Standard Round		477.0 <sup>26/7, 24/7, 18/1, 397.5<sup>30/7, 26/7</sup></sup>	6 <sup>6/1</sup>	4 <sup>7/1, 6/1, 5<sup>6/1</sup></sup>	2 <sup>6/1, 3<sup>6/1</sup></sup>	2 <sup>6/1, 7/1</sup>	80.0 <sup>8/1, 1<sup>6/1</sup></sup>
AAAC 6201 - 5003		465.4, 466.3, 503.6, 559.5, 599.6	6	4, 5	3	2	1
AAC Standard Round		477.0, 500.0, 550.0, 556.5	6	3, 4	2	1	1/0
COPPER Standard Round		500.0, 550.0	5, 6	4	2	1	1/0
AAC Compressed or Compacted		—	6	3, 4	2	1	1/0
ACSR Compressed or Compacted		556.5, 636.0 <sup>18/1</sup>	6 <sup>6/1</sup>	4 <sup>7/1, 6/1</sup>	2 <sup>6/1, 7/1</sup>	1 <sup>6/1</sup>	1/0 <sup>6/1</sup>
AWAC, ACAR		503.6 <sup>15/4, 12/7</sup>	—	4 <sup>6/1</sup>	4 <sup>4/3, 5/2, 3<sup>5/2, 6/1</sup></sup>	4 <sup>2/5, 3/4, 3<sup>4/3, 2<sup>5/2, 6/1</sup></sup></sup>	3 <sup>3/4, 2<sup>4/3, 1<sup>5/2, 6/1</sup></sup></sup>
ALUMOWELD COPPERWELD		19 No.6, 37 No.9	8A, 8C, 3 No. 12	8D, 7D, 7A, 6A, 6C, 3 No. 9, 3 No. 10, 7 No. 12	6D, 5D, 5A, 4A, 3 No.8, 7 No. 11	4N, 3A, 2G, 2F, 3 No.7, 7 No.10	4D, 4P, 2K, 2A, 2J, 1G, 1F, 3 No.6, 7 No.9
Galvanized Steel		—	3/16"	1/4", 7/32"	9/32"	11/32"	3/8"
Solid: AL or CU		—	5, 6	4, 3	2, 1	1/0	2/0

Use TAP Number	I-602031-3*	2-602031-2*	2-602031-1*	2-602031-0*	1-602031-9*	I-602031-8*
----------------	-------------	-------------	-------------	-------------	-------------	-------------

\*UL Listed

Aluminum Taps

Large Wire Groove Code						
ACSR Standard Round	556.5 <sup>26/7, 24/7, 18/1, 447.0<sup>30/7, 26/7</sup></sup>	556.5 <sup>26/7, 24/7, 18/1, 447.0<sup>30/7, 26/7</sup></sup>	556.5 <sup>26/7, 24/7, 18/1, 447.0<sup>30/7, 26/7</sup></sup>	556.5 <sup>26/7, 24/7, 18/1, 447.0<sup>30/7, 26/7</sup></sup>	556.5 <sup>26/7, 24/7, 18/1, 447.0<sup>30/7, 26/7</sup></sup>	556.5 <sup>26/7, 24/7, 18/1, 447.0<sup>30/7, 26/7</sup></sup>
AAAC 6201 - 5003	559.5, 587.2, 599.6, 652.4, 652.8	559.5, 587.2, 599.6, 652.4, 652.8	559.5, 587.2, 599.6, 652.4, 652.8	559.5, 587.2, 599.6, 652.4, 652.8	559.5, 587.2, 599.6, 652.4, 652.8	559.5, 587.2, 599.6, 652.4, 652.8
AAC Standard Round	556.5, 600.0, 636.0	556.5, 600.0, 636.0	556.5, 600.0, 636.0	556.5, 600.0, 636.0	556.5, 600.0, 636.0	556.5, 600.0, 636.0
COPPER Standard Round	550.0, 600.0	550.0, 600.0	550.0, 600.0	550.0, 600.0	550.0, 600.0	550.0, 600.0
AAC Compressed or Compacted	-	-	-	-	-	-
ACSR Compressed or Compacted	636.0 <sup>18/1</sup>	636.0 <sup>18/1</sup>	636.0 <sup>18/1</sup>	636.0 <sup>18/1</sup>	636.0 <sup>18/1</sup>	636.0 <sup>18/1</sup>
AWAC, ACAR	653.1 <sup>15/4, 12/7, 568.3<sup>15/4</sup></sup>	653.1 <sup>15/4, 12/7, 568.3<sup>15/4</sup></sup>	653.1 <sup>15/4, 12/7, 568.3<sup>15/4</sup></sup>	653.1 <sup>15/4, 12/7, 568.3<sup>15/4</sup></sup>	653.1 <sup>15/4, 12/7, 568.3<sup>15/4</sup></sup>	653.1 <sup>15/4, 12/7, 568.3<sup>15/4</sup></sup>
ALUMOWELD	19 No. 5, 37 No. 8	19 No. 5, 37 No. 8	19 No. 5, 37 No. 8	19 No. 5, 37 No. 8	19 No. 5, 37 No. 8	19 No. 5, 37 No. 8
COPPERWELD	19 No. 5, 37 No. 8	19 No. 5, 37 No. 8	19 No. 5, 37 No. 8	19 No. 5, 37 No. 8	19 No. 5, 37 No. 8	19 No. 5, 37 No. 8
Galvanized Steel	7/8"	7/8"	7/8"	7/8"	7/8"	7/8"
Solid: AL or CU	-	-	-	-	-	-

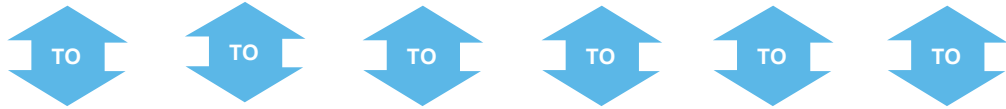

















ACSR Standard Round	1/0 <sup>6/1</sup>	110.8, 101.8 <sup>12/7, 2/0<sup>6/1</sup></sup>	4/0 <sup>6/1, 3/0<sup>6/1</sup></sup>	266.8 <sup>30/7, 26/7, 24/7, 6/7, 18/1</sup>	336.4, 397.5 <sup>30/7, 26/7, 24/7, 18/1</sup>	477.0, 556.5 <sup>26/7, 24/7, 18/1, 477.0<sup>30/7</sup></sup>
AAAC 6201 - 5003	1/0	2/0	4/0, 3/0	281.4, 307.1, 312.8	355.1, 394.5, 419.6, 465.4, 466.3	652.8, 652.4, 599.6, 503.6, 587.2, 559.2
AAC Standard Round	2/0	3/0	4/0	250.0, 266.8, 300.0	336.4, 350.0, 397.5, 400.0, 450.0, 477.0	636.0, 600.0, 500.0, 550.0, 556.5
COPPER Standard Round	2/0	3/0	4/0	250.0, 300.0	350.0, 400.0, 450.0	500.0, 600.0, 550.0
AAC Compressed or Compacted	-	3/0	4/0, 250.0	266.8, 300.0, 336.4, 350.0	397.5, 477.0, 500.0	-
ACSR Compressed or Compacted	2/0 <sup>6/1</sup>	3/0 <sup>6/1</sup>	266.8 <sup>18/1, 4/0<sup>6/1</sup></sup>	366.4 <sup>18/1</sup>	556.5, 397.5, 477.0 <sup>18/1</sup>	636.0 <sup>18/1</sup>
AWAC, ACAR	1/0 <sup>5/2, 6/1, 1<sup>3/4, 4/3, 2<sup>2/5, 3/4, 3<sup>2/5</sup></sup></sup></sup>	3/0 <sup>6/1, 2/0<sup>5/2, 6/1, 1/0<sup>3/4, 4/3, 1<sup>2/5</sup></sup></sup></sup>	4/0 <sup>6/1, 3/0<sup>5/2, 4/3, 2/0<sup>3/4, 4/3, 1/0<sup>2/5</sup></sup></sup></sup>	4/0 <sup>15/4</sup>	336.4 <sup>15/4, 16/3, 18/1, 343.6<sup>15/4, 355.0<sup>15/4, 12/7</sup></sup></sup>	503.6, 653.1 <sup>15/4, 12/7, 568.3<sup>15/4</sup></sup>
ALUMOWELD	1/0G, 1/0F, 1K, 1J, 2N, 7 No. 7, 7 No. 8, 3 No. 5	3/0F, 2/0J, 2/0G, 1/0K, 1/0J, 1N, 2P, 2/0F, 7 No. 6	19 No. 9, 19 No. 10, 7 No. 5, 4/0F, 2/0K	19 No. 8, 7 No. 4, 4/0E, 4/0G	19 No. 7, 37 No. 9, 37 No. 10	19 No. 6, 19 No. 5, 37 No. 8
COPPERWELD	19 No. 5, 37 No. 8	19 No. 5, 37 No. 8	19 No. 5, 37 No. 8	19 No. 5, 37 No. 8	19 No. 5, 37 No. 8	19 No. 5, 37 No. 8
Galvanized Steel	-	7/16"	9/16", 1/2"	5/8"	3/4"	7/8"
Solid: AL or CU	3/0	4/0	300.0, 250.0	400.0, 350.0	450.0, 500.0	-

Use TAP Number	I-602031-7*	I-602031-6*	1-602031-5*	1-602031-4*	1-602031-3*	1-602031-2*
----------------	-------------	-------------	-------------	-------------	-------------	-------------









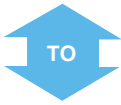

\*UL Listed



## Aluminum Taps

Large Wire Groove Code						
ACSR Standard Round		605.0 <sup>54/7, 24/7</sup> , 653.9 <sup>18/3</sup> , 556.5 <sup>30/7</sup>	605.0 <sup>54/7, 24/7</sup> , 653.9 <sup>18/3</sup> , 556.5 <sup>30/7</sup>	605.0 <sup>54/7, 24/7</sup> , 653.9 <sup>18/3</sup> , 556.5 <sup>30/7</sup>	605.0 <sup>54/7, 24/7</sup> , 653.9 <sup>18/3</sup> , 556.5 <sup>30/7</sup>	605.0 <sup>54/7, 24/7</sup> , 653.9 <sup>18/3</sup> , 556.5 <sup>30/7</sup>
AAAC 6201 - 5003		-	-	-	-	-
AAC Standard Round		-	-	-	-	-
COPPER Standard Round		-	-	-	-	-
AAC Compressed or Compacted		-	-	-	-	-
ACSR Compressed or Compacted		-	-	-	-	-
AWAC, ACAR		-	-	-	-	-
ALUMOWELD		-	-	-	-	-
COPPERWELD		-	-	-	-	-
Galvanized Steel		-	-	-	-	-
Solid: AL or CU		-	-	-	-	-



































ACSR Standard Round		4 <sup>7/1, 6/1, 5<sup>6/1</sup></sup>	2 <sup>7/1, 6/1, 3<sup>6/1</sup></sup>	1/0 <sup>6/1, 1<sup>6/1</sup></sup> , 80.0 <sup>8/1</sup>	2/0 <sup>6/1</sup>	3/0 <sup>6/1, 101.8,</sup> 110.8, 134.6 <sup>12/7</sup>	4/0 <sup>6/1, 159.0<sup>12/7</sup></sup>						
AAAC 6201 - 5003		4, 5	2, 3	1/0, 1	2/0	3/0	4/0						
AAC Standard Round		3, 4, 5	2	1/0	2/0	3/0	250.0, 4/0						
COPPER Standard Round		4, 5	2, 3	1/0	2/0	3/0	250.0, 4/0						
AAC Compressed or Compacted		3, 4	1, 2	2/0, 1/0	3/0	250.0, 4/0	266.8, 300.0						
ACSR Compressed or Compacted		4 <sup>7/1, 6/1</sup>	2 <sup>7/1, 6/1, 1<sup>6/1</sup></sup>	1/0 <sup>6/1</sup>	2/0 <sup>6/1</sup>	4/0 <sup>6/1, 3/0<sup>6/1</sup></sup>	266.8 <sup>18/1</sup>						
AWAC, ACAR		4 <sup>6/1</sup>	2 <sup>6/1, 3<sup>5/2, 4/3,</sup></sup> 6/1, 4 <sup>4/3, 3/4</sup>	1/0 <sup>6/1, 1<sup>5/2, 4/3,</sup></sup> 6/1, 2 <sup>4/3, 3/4,</sup>	2/0 <sup>6/1, 1/0<sup>5/2, 4/3,</sup></sup> 1 <sup>3/4, 2<sup>2/5</sup></sup>	2/0 <sup>5/2, 4/3,</sup>	4/0 <sup>15/4, 6/1,</sup>	3/0 <sup>5/2, 6/1,</sup>	3/0 <sup>4/3, 2/0<sup>3/4,</sup></sup>	1/0 <sup>2/5</sup>			
ALUMOWELD		5A, 6A, 6C, 7A, 7D, 8D,	2F, 3A, 4A, 5D, 6D, 3 No. 8,	1J, 1G, 1F, 2K, 2J, 2A,	2/0F, 1/0G,	3/0F, 2/0J, 2/0G, 1/0K,	4/0G, 4/0F,	7 No. 12, 3 No.10, 3 No.9	7 No. 10, 7 No.11	3 No. 6, 3 No.5, 7 No.8, 7 No.9	7 No.7	1N, 2P, 7 No. 6, 19 No.10	2/0K, 19 No. 9, 7 No. 5
COPPERWELD													
Galvanized Steel		1/4", 7/32"	5/16", 9/32"	3/8", 11/32"	7/16"	1/2"	9/16"						
Solid: AL or CU		2, 3, 4	1/0, 1	2/0	3/0	250.0, 266.8, 4/0	300.0, 336.4						

Use TAP Number	I-60121-4*	I-602121-3*	I-602121-2*	1-602121-1*	1-602121-0*	602121-9*
----------------	------------	-------------	-------------	-------------	-------------	-----------

\*UL Listed

Aluminum Taps

Large Wire Groove Code						
ACSR Standard Round 	605.0 <sup>54/7, 24/7</sup> , 653.9 <sup>18/3</sup> , 556.5 <sup>30/7</sup>	605.0 <sup>54/7, 24/7</sup> , 653.9 <sup>18/3</sup> , 556.5 <sup>30/7</sup>	605.0 <sup>54/7, 24/7</sup> , 653.9 <sup>18/3</sup> , 556.5 <sup>30/7</sup>	605.0 <sup>54/7, 24/7</sup> , 653.9 <sup>18/3</sup> , 556.5 <sup>30/7</sup>	605.0 <sup>54/7, 24/7</sup> , 653.9 <sup>18/3</sup> , 556.5 <sup>30/7</sup>	605.0 <sup>54/7, 24/7</sup> , 653.9 <sup>18/3</sup> , 556.5 <sup>30/7</sup>
AAAC 6201 - 5003 	-	-	-	-	-	-
AAC Standard Round 	-	-	-	-	-	-
COPPER Standard Round 	-	-	-	-	-	-
AAC Compressed or Compacted 	-	-	-	-	-	-
ACSR Compressed or Compacted 	-	-	-	-	-	-
AWAC, ACAR 	-	-	-	-	-	-
ALUMOWELD 	-	-	-	-	-	-
COPPERWELD	-	-	-	-	-	-
Galvanized Steel 	-	-	-	-	-	-
Solid: AL or CU 	-	-	-	-	-	-
						
ACSR Standard Round 	266.8 <sup>30/7, 26/7, 24/7, 18/1, 6/7</sup> , 300.0 <sup>30/7, 26/7, 24/7, 18/1</sup> , 176.9, 190.8 <sup>12/7</sup>	336.4 <sup>26/7, 24/7, 18/1, 211.3<sup>12/7</sup>, 203.2<sup>16/19</sup></sup>	397.5 <sup>18/1, 336.4<sup>30/7</sup></sup>	477.0 <sup>30/7, 26/7, 24/7, 18/1, 397.5<sup>30/7</sup></sup>	556.5 <sup>18/1, 500.0<sup>30/7</sup></sup>	636.0 <sup>54/7, 30/19, 30/7, 26/7, 24/7, 18/1, 605.0, 653.9<sup>18/3</sup>, 556.5<sup>30/7</sup></sup>
AAAC 6201 - 5003 	281.4, 307.1, 312.8	355.1, 394.5	419.6	503.6, 559.5, 587.2, 599.6	-	704.6, 740.8, 746.1
AAC Standard Round 	266.8, 300.0	336.4, 350.0	-	500.0, 550.0, 556.5	600.0	700.0, 715.5, 750.0
COPPER Standard Round 	300.0	350.0, 400.0	-	500.0, 550.0	600.0	700.0, 750.0
AAC Compressed or Compacted 	336.4, 350.0	397.5, 477.0	500.0	636.0	-	874.5
ACSR Compressed or Compacted 	336.4, <sup>18/1</sup>	397.5 <sup>18/1</sup>	477.0 <sup>18/1</sup>	556.5, 636.0 <sup>18/1</sup>	-	874.5 <sup>36/1</sup>
AWAC, ACAR 	-	355.0 <sup>15/4, 12/7, 343.6<sup>15/4</sup>, 336.4<sup>15/4</sup>, 16/3, 18/1</sup>	-	568.3 <sup>15/4</sup> , 503.6 <sup>15/4, 12/7</sup>	-	739.8 <sup>30/7, 33/4, 24/13, 18/19</sup>
ALUMOWELD 	4/0E, 19 No. 8, 7 No. 4	19 No. 7, 37 No. 10	-	19 No. 6, 37 No. 9	37 No. 8	-
COPPERWELD	-	-	-	-	-	-
Galvanized Steel 	<sup>5/8</sup> "	-	<sup>3/4</sup> "	<sup>7/8</sup> "	-	1"
Solid: AL or CU 	350.0, 397.5, 400.0	450.0, 477.0, 500.0	-	-	-	-
<b>Use TAP Number</b>	<b>602121-8*</b>	<b>602121-7*</b>	<b>602121-6*</b>	<b>602121-5*</b>	<b>602121-4*</b>	<b>602121-3*</b>

\*UL Listed

## Aluminum Taps

Large Wire Groove Code						
ACSR Standard Round	605.0 <sup>54/7, 24/7</sup> , 653.9 <sup>18/3</sup> , 556.5 <sup>30/7</sup>	605.0 <sup>54/7, 24/7</sup> , 653.9 <sup>18/3</sup> , 556.5 <sup>30/7</sup>	605.0 <sup>54/7, 24/7</sup> , 653.9 <sup>18/3</sup> , 556.5 <sup>30/7</sup>	636.0 <sup>30/19, 30/7, 26/7, 24/7</sup> , 666.6 <sup>54/7, 26/7, 24/7, 715.5<sup>45/7</sup></sup> , 605.0 <sup>30/19, 30/7</sup>	636.0 <sup>30/19, 30/7, 26/7, 24/7</sup> , 666.6 <sup>54/7, 26/7, 24/7, 715.5<sup>45/7</sup></sup> , 605.0 <sup>30/19, 30/7</sup>	636.0 <sup>30/19, 30/7, 26/7, 24/7</sup> , 666.6 <sup>54/7, 26/7, 24/7, 715.5<sup>45/7</sup></sup> , 605.0 <sup>30/19, 30/7</sup>
AAAC 6201 - 5003	–	–	–	740.8, 746.1	740.8, 746.1	740.8, 746.1
AAC Standard Round	–	–	–	715.5, 750.0	715.5, 750.0	715.5, 750.0
COPPER Standard Round	–	–	–	750.0	750.0	750.0
AAAC Compressed or Compacted	–	–	–	874.5	874.5	874.5
ACSR Compressed or Compacted	–	–	–	874.5 <sup>36/1</sup>	874.5 <sup>36/1</sup>	874.5 <sup>36/1</sup>
AWAC, ACAR	–	–	–	739.8 <sup>30/7, 33/4, 24/13, 18/19</sup>	739.8 <sup>30/7, 33/4, 24/13, 18/19</sup>	739.8 <sup>30/7, 33/4, 24/13, 18/19</sup>
ALUMOWELD	–	–	–	37 No. 7	37 No. 7	37 No. 7
COPPERWELD	–	–	–	–	–	–
Galvanized Steel	–	–	–	1"	1"	1"
Solid: AL or CU	–	–	–	–	–	–
ACSR Standard Round	715.5 <sup>54/7, 45/7, 26/7, 24/7</sup> , 666.6 <sup>54/7, 26/7, 24/7</sup> , 795.0 <sup>36/1</sup>	795.0 <sup>54/7, 45/7, 30/19, 30/7, 26/7, 24/7</sup> , 874.5 <sup>54/7, 45/7</sup> , 715.5 <sup>30/19, 30/7</sup>	954.0 <sup>36/1</sup> , 900.0 <sup>45/7</sup>	6 <sup>6/1</sup> , 5 <sup>6/1</sup>	4 <sup>7/1</sup> , 6 <sup>1/1</sup> , 3 <sup>6/1</sup>	2 <sup>7/1</sup> , 6 <sup>1/1</sup> , 1 <sup>6/1</sup> , 80.0 <sup>6/1</sup>
AAAC 6201 - 5003	833.6	927.2, 932.6	–	5, 6	3, 4	1, 2
AAC Standard Round	795.0, 800.0	874.5, 900.0	954.0, 1000.0	4, 5, 6	2, 3	1/0, 1
COPPER Standard Round	800.0	850.0, 900.0	1000.0	4, 5, 6	2, 3	1/0, 1
AAAC Compressed or Compacted	954.0	–	–	3, 4	1, 2	2/0, 1/0
ACSR Compressed or Compacted	954.0 <sup>36/1</sup>	–	–	4 <sup>7/1</sup> , 6 <sup>1/1</sup>	2 <sup>7/1</sup> , 6 <sup>1/1</sup>	1/0, 1 <sup>6/1</sup>
AWAC, ACAR	853.7 <sup>30/7, 24/13, 18/19</sup> , 862.7 <sup>18/19</sup> , 840.2 <sup>24/13</sup> , 819.2 <sup>30/7</sup>	927.2 <sup>30/7, 24/13, 18/19</sup>	1012.2 <sup>24/13</sup> , 983.1 <sup>30/7</sup>	4 <sup>6/1</sup>	2 <sup>6/1</sup> , 3 <sup>5/2</sup> , 6 <sup>1/1</sup> , 4 <sup>4/3</sup> , 5 <sup>2/3</sup> , 3 <sup>4/4</sup>	1/0 <sup>6/1</sup> , 1 <sup>5/2</sup> , 6 <sup>1/1</sup> , 2 <sup>4/3</sup> , 5 <sup>2/3</sup> , 3 <sup>4/4</sup> , 3 <sup>4/3</sup> , 2 <sup>5/5</sup> , 3 <sup>3/4</sup> , 4 <sup>2/5</sup>
ALUMOWELD	–	–	–	6A, 6C, 7A, 7D, 8A, 8D, 3 No. 10, 7 No. 12	2F, 4A, 5A, 5D, 6A, 3 No. 7, 3 No. 8, 3 No. 9, 7 No. 10, 7 No. 11	1/0F, 1F, 1G, 2A, 2G, 2J, 2K, 3A, 4D, 4N, 4P, 3 No. 6, 7 No. 8, 7 No. 9
COPPERWELD	37 No. 7	37 No. 6	–	–	–	–
Galvanized Steel	–	–	–	1/4", 7/32", 3/16"	9/32"	3/8", 11/32", 5/16"
Solid: AL or CU	–	–	–	3, 4, 5	1, 2	2/0, 1/0
<b>Use TAP Number</b>	<b>602121-2*</b>	<b>602121-1*</b>	<b>602121*</b>	<b>I-602121-4*</b>	<b>I-602121-3*</b>	<b>1-602121-2*</b>

\*UL Listed

Aluminum Taps

Large Wire Groove Code						
ACSR Standard Round	636.0 <sup>30/19</sup> , 30/7, 26/7, 24/7, 666.6 <sup>54/7</sup> , 26/7, 24/7, 715.5 <sup>45/7</sup> , 605.0 <sup>30/19</sup> , 30/7	636.0 <sup>30/19</sup> , 30/7, 26/7, 24/7, 666.6 <sup>54/7</sup> , 26/7, 24/7, 715.5 <sup>45/7</sup> , 605.0 <sup>30/19</sup> , 30/7	636.0 <sup>30/19</sup> , 30/7, 26/7, 24/7, 666.6 <sup>54/7</sup> , 26/7, 24/7, 715.5 <sup>45/7</sup> , 605.0 <sup>30/19</sup> , 30/7	636.0 <sup>30/19</sup> , 30/7, 26/7, 24/7, 666.6 <sup>54/7</sup> , 26/7, 24/7, 715.5 <sup>45/7</sup> , 605.0 <sup>30/19</sup> , 30/7	636.0 <sup>30/19</sup> , 30/7, 26/7, 24/7, 666.6 <sup>54/7</sup> , 26/7, 24/7, 715.5 <sup>45/7</sup> , 605.0 <sup>30/19</sup> , 30/7	636.0 <sup>30/19</sup> , 30/7, 26/7, 24/7, 666.6 <sup>54/7</sup> , 26/7, 24/7, 715.5 <sup>45/7</sup> , 605.0 <sup>30/19</sup> , 30/7
AAAC 6201 - 5003	740.8, 746.1	740.8, 746.1	740.8, 746.1	740.8, 746.1	740.8, 746.1	740.8, 746.1
AAC Standard Round	715.5, 750.0	715.5, 750.0	715.5, 750.0	715.5, 750.0	715.5, 750.0	715.5, 750.0
COPPER Standard Round	750.0	750.0	750.0	750.0	750.0	750.0
AAC Compressed or Compacted	874.5	874.5	874.5	874.5	874.5	874.5
ACSR Compressed or Compacted	874.5 <sup>36/1</sup>	874.5 <sup>36/1</sup>	874.5 <sup>36/1</sup>	874.5 <sup>36/1</sup>	874.5 <sup>36/1</sup>	874.5 <sup>36/1</sup>
AWAC, ACAR	739.8 <sup>30/7</sup> , 33/4, 24/13, 18/19	739.8 <sup>30/7</sup> , 33/4, 24/13, 18/19	739.8 <sup>30/7</sup> , 33/4, 24/13, 18/19	739.8 <sup>30/7</sup> , 33/4, 24/13, 18/19	739.8 <sup>30/7</sup> , 33/4, 24/13, 18/19	739.8 <sup>30/7</sup> , 33/4, 24/13, 18/19
ALUMOWELD	37 No. 7	37 No. 7	37 No. 7	37 No. 7	37 No. 7	37 No. 7
COPPERWELD						
Galvanized Steel	1"	1"	1"	1"	1"	1"
Solid: AL or CU	-	-	-	-	-	-

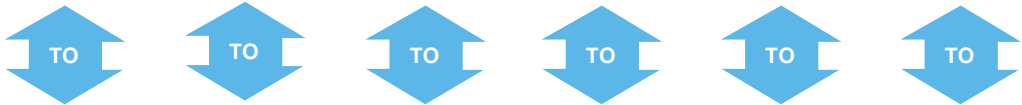

ACSR Standard Round	1/0 <sup>6/1</sup>	3/0 <sup>6/1</sup> , 2/0 <sup>6/1</sup> , 101.8, 110.8 <sup>12/7</sup>	4/0 <sup>6/1</sup> , 134.6 <sup>12/7</sup>	266.8 <sup>26/7</sup> , 24/7, 18/1, 6/7, 176.9, 159.0, 190.8 <sup>12/7</sup>	336.4 <sup>26/7</sup> , 24/7, 18/1, 266.8 <sup>30/7</sup> , 211.3 <sup>12/7</sup> , 300.0 <sup>30/7</sup> , 26/7, 24/7, 18/1	397.5 <sup>26/7</sup> , 24/7, 18/1, 336.4 <sup>30/7</sup> , 203.2 <sup>16/19</sup>
AAAC 6201 - 5003	1/0	2/0, 3/0	4/0	281.4, 307.1, 312.8	355.1, 394.5	419.6, 465.4, 466.3
AAC Standard Round	2/0	3/0	4/0	250.0, 266.8, 300.0	336.4, 350.0	397.5, 400.0, 450.0
COPPER Standard Round	2/0	3/0	4/0	250.0, 300.0	350.0	400.0, 450.0
AAC Compressed or Compacted	3/0	4/0	250.0, 266.8	300.0, 336.4, 350.0	397.5, 477.0	500.0, 556.5
ACSR Compressed or Compacted	2/0 <sup>6/1</sup>	3/0 <sup>6/1</sup>	266.8 <sup>18/1</sup> , 4/0 <sup>6/1</sup>	336.4 <sup>18/1</sup>	397.5 <sup>18/1</sup>	477.0 <sup>18/1</sup>
AWAC, ACAR	2/0 <sup>6/1</sup> , 1/0 <sup>5/2</sup> , 1 <sup>3/4</sup> , 4/3, 2 <sup>2/5</sup>	3/0 <sup>6/1</sup> , 2/0 <sup>5/2</sup> , 1/0 <sup>4/3</sup> , 3/4, 1 <sup>2/5</sup>	4/0 <sup>6/1</sup> , 3/0 <sup>4/3</sup> , 5/2, 2/0 <sup>4/3</sup> , 3/4, 1/0 <sup>2/5</sup>	4/0 <sup>15/4</sup>	355.0 <sup>15/4</sup> , 12/7, 343.6 <sup>15/4</sup> , 336.4 <sup>16/3</sup> , 18/1	336.4 <sup>15/4</sup>
ALUMOWELD	2/0 F, 1/0 G, 1/0 J, 1J, 1K, 2N, 7 No. 7, 3 No. 5	3/0F, 2/0J, 2/0G, 1/0K, 1N, 2P, 7 No. 6	4/0F, 2/0K, 19 No. 10, 7 No. 5	4/0 E, 4/0 G, 19 No. 9, 7 No. 4	19 No. 8	37 No. 10, 19 No. 7
COPPERWELD						
Galvanized Steel	7/16"	-	9/16", 1/2"	5/8"	-	3/4"
Solid: AL or CU	3/0	4/0	250.0, 266.8 300.0	336.4, 350.0, 397.5, 400.0	450.0, 477.0, 500.0	-

<b>Use TAP Number</b>	<b>1-602121-1*</b>	<b>1-602121-0*</b>	<b>602121-9*</b>	<b>602121-8*</b>	<b>602121-7*</b>	<b>602121-6*</b>
-----------------------	--------------------	--------------------	------------------	------------------	------------------	------------------

\*UL Listed

# Aluminum Taps

Large Wire Groove Code						
ACSR Standard Round	636.0 <sup>30/19, 30/7, 26/7, 24/7, 666.6<sup>54/7, 26/7, 24/7, 715.5<sup>45/7, 605.0<sup>30/19, 30/7</sup></sup></sup></sup>	636.0 <sup>30/19, 30/7, 26/7, 24/7, 666.6<sup>54/7, 26/7, 24/7, 715.5<sup>45/7, 605.0<sup>30/19, 30/7</sup></sup></sup></sup>	636.0 <sup>30/19, 30/7, 26/7, 24/7, 666.6<sup>54/7, 26/7, 24/7, 715.5<sup>45/7, 605.0<sup>30/19, 30/7</sup></sup></sup></sup>	636.0 <sup>30/19, 30/7, 26/7, 24/7, 666.6<sup>54/7, 26/7, 24/7, 715.5<sup>45/7, 605.0<sup>30/19, 30/7</sup></sup></sup></sup>	636.0 <sup>30/19, 30/7, 26/7, 24/7, 666.6<sup>54/7, 26/7, 24/7, 715.5<sup>45/7, 605.0<sup>30/19, 30/7</sup></sup></sup></sup>	636.0 <sup>30/19, 30/7, 26/7, 24/7, 666.6<sup>54/7, 26/7, 24/7, 715.5<sup>45/7, 605.0<sup>30/19, 30/7</sup></sup></sup></sup>
AAAC 6201 - 5003	740.8, 746.1	740.8, 746.1	740.8, 746.1	740.8, 746.1	740.8, 746.1	740.8, 746.1
AAC Standard Round	715.5, 750.0	715.5, 750.0	715.5, 750.0	715.5, 750.0	715.5, 750.0	715.5, 750.0
COPPER Standard Round	750.0	750.0	750.0	750.0	750.0	750.0
AAC Compressed or Compacted	874.5	874.5	874.5	874.5	874.5	874.5
ACSR Compressed or Compacted	874.5 <sup>36/1</sup>	874.5 <sup>36/1</sup>	874.5 <sup>36/1</sup>	874.5 <sup>36/1</sup>	874.5 <sup>36/1</sup>	874.5 <sup>36/1</sup>
AWAC, ACAR	739.8 <sup>30/7, 33/4, 24/13, 18/19</sup>	739.8 <sup>30/7, 33/4, 24/13, 18/19</sup>	739.8 <sup>30/7, 30/7, 33/4, 24/13, 18/19</sup>	739.8 <sup>30/7, 33/4, 24/13, 18/19</sup>	739.8 <sup>30/7, 33/4, 24/13, 18/19</sup>	739.8 <sup>30/7, 30/7, 33/4, 24/13, 18/19</sup>
ALUMOWELD COPPERWELD	37 No. 7	37 No. 7	37 No. 7	37 No. 7	37 No. 7	37 No. 7
Galvanized Steel	1"	1"	1"	1"	1"	1"
Solid: AL or CU	-	-	-	-	-	-

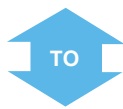











ACSR Standard Round	477.0 <sup>26/7, 24/7, 18/1, 397.5<sup>30/7</sup></sup>	556.5 <sup>26/7, 24/7, 18/1, 477.0, 500.0<sup>30/7</sup></sup>	636.0 <sup>54/7, 26/7, 24/7, 36/1, 18/1, 605.0<sup>54/7, 30/7, 26/7, 24/7, 556.5<sup>30/7</sup></sup></sup>	666.6 <sup>54/7, 26/7, 24/7, 636.0<sup>30/19, 30/7, 715.5<sup>45/7</sup></sup></sup>	795.0 <sup>54/7, 45/7, 26/7, 24/7, 36/1, 715.5<sup>54/7, 26/7, 24/7, 30/19, 30/7</sup></sup>	795.0 <sup>30/7, 30/19, 954.0<sup>36/1, 900.0<sup>45/7, 874.5<sup>45/7, 45/7</sup></sup></sup></sup>
AAAC 6201 - 5003	503.6	559.5, 587.2, 599.6	652.4, 652.8, 704.6, 740.8	-	833.6	927.2, 932.6
AAC Standard Round	477.0, 500.0	550.0, 556.5, 600.0	636.0, 650.0, 715.5, 700.0	750.0	795.0, 800.0, 874.5, 900.0	954.0, 1000.0
COPPER Standard Round	500.0	550.0, 600.0	650.0, 700.0	750.0	800.0, 850.0, 900.0	1000.0
AAC Compressed or Compacted	636.0	-	795.0, 874.5	-	954.0	-
ACSR Compressed or Compacted	556.5 <sup>18/1</sup>	636.0 <sup>18/1</sup>	874.5, 795.0 <sup>36/1</sup>	-	954.0 <sup>36/1</sup>	-
AWAC, ACAR	503.6 <sup>15/4, 12/7</sup>	653.1 <sup>15/4, 12/7, 568.3<sup>15/4</sup></sup>	739.8 <sup>30/7, 33/4, 24/3, 18/9</sup>	-	853.7 <sup>30/7, 24/13, 18/19, 862.7<sup>18/19, 840.2<sup>24/13, 819.2<sup>30/7</sup></sup></sup></sup>	1012.2 <sup>24/13, 983.1<sup>30/7, 927.2<sup>30/7, 24/13, 18/19</sup></sup></sup>
ALUMOWELD COPPERWELD	19 No. 6, 37 No. 9	37 No. 8, 19 No. 5	-	37 No. 7	-	37 No. 6
Galvanized Steel	-	7/8"	-	1"	-	-
Solid: AL or CU	-	-	-	-	-	-











<b>Use TAP Number</b>	<b>602121-5*</b>	<b>602121-4*</b>	<b>602121-3*</b>	<b>602121-2*</b>	<b>602121-1*</b>	<b>602121*</b>
-----------------------	------------------	------------------	------------------	------------------	------------------	----------------

\*UL Listed

## Aluminum Taps

Large Wire Groove Code						
ACSR Standard Round		795.0 <sup>54/7, 45/7, 26/7, 24/7, 36/1, 715.5<sup>54/7, 30/19, 30/7, 26/7, 24/7</sup></sup>	795.0 <sup>54/7, 45/7, 26/7, 24/7, 36/1, 715.5<sup>54/7, 30/19, 30/7, 26/7, 24/7</sup></sup>	795.0 <sup>54/7, 45/7, 26/7, 24/7, 36/1, 715.5<sup>54/7, 30/19, 30/7, 26/7, 24/7</sup></sup>	795.0 <sup>54/7, 45/7, 26/7, 24/7, 36/1, 715.5<sup>54/7, 30/19, 30/7, 26/7, 24/7</sup></sup>	795.0 <sup>54/7, 45/7, 26/7, 24/7, 36/1, 715.5<sup>54/7, 30/19, 30/7, 26/7, 24/7</sup></sup>
AAAC 6201 - 5003		833.6, 927.2, 932.6	833.6, 927.2, 932.6	833.6, 927.2, 932.6	833.6, 927.2, 932.6	833.6, 927.2, 932.6
AAC Standard Round		795.0, 800.0, 874.5, 900.0	795.0, 800.0, 874.5, 900.0	795.0, 800.0, 874.5, 900.0	795.0, 800.0, 874.5, 900.0	795.0, 800.0, 874.5, 900.0
COPPER Standard Round		800.0, 850.0, 900.0	800.0, 850.0, 900.0	800.0, 850.0, 900.0	800.0, 850.0, 900.0	800.0, 850.0, 900.0
AAC Compressed or Compacted		954.0	954.0	954.0	954.0	954.0
ACSR Compressed or Compacted		954.0 <sup>36/1</sup>	954.0 <sup>36/1</sup>	954.0 <sup>36/1</sup>	954.0 <sup>36/1</sup>	954.0 <sup>36/1</sup>
AWAC, ACAR		853.7, 927.2 <sup>30/7, 24/13, 18/19, 862.7<sup>18/19, 840.2<sup>24/13, 819.2<sup>30/7</sup></sup></sup></sup>	853.7, 927.2 <sup>30/7, 24/13, 18/19, 862.7<sup>18/19, 840.2<sup>24/13, 819.2<sup>30/7</sup></sup></sup></sup>	853.7, 927.2 <sup>30/7, 24/13, 18/19, 862.7<sup>18/19, 840.2<sup>24/13, 819.2<sup>30/7</sup></sup></sup></sup>	853.7, 927.2 <sup>30/7, 24/13, 18/19, 862.7<sup>18/19, 840.2<sup>24/13, 819.2<sup>30/7</sup></sup></sup></sup>	853.7, 927.2 <sup>30/7, 24/13, 18/19, 862.7<sup>18/19, 840.2<sup>24/13, 819.2<sup>30/7</sup></sup></sup></sup>
ALUMOWELD		-	-	-	-	-
COPPERWELD		-	-	-	-	-
Galvanized Steel		-	-	-	-	-
Solid: AL or CU		-	-	-	-	-



ACSR Standard Round		6 <sup>6/1</sup>	4 <sup>7/1, 6/1, 5<sup>6/1</sup></sup>	2 <sup>7/1, 6/1, 3<sup>6/1</sup></sup>	1/0 <sup>6/1, 1<sup>6/1, 80.0<sup>6/1</sup></sup></sup>	2/0 <sup>6/1</sup>	3/0 <sup>6/1, 101.8, 110.8<sup>12/7</sup></sup>
AAAC 6201 - 5003		6	4, 5	2, 3	1/0, 1	2/0	3/0
AAC Standard Round		6	3, 4, 5	1, 2	1/0	2/0	3/0
COPPER Standard Round		6	3, 4, 5	1, 2	1/0	2/0	3/0
AAC Compressed or Compacted		6	3, 4	2	2/0, 1/0	3/0	4/0
ACSR Compressed or Compacted		6 <sup>6/1</sup>	4 <sup>7/1, 6/1</sup>	1 <sup>6/1, 2<sup>7/1, 6/1</sup></sup>	1/0 <sup>6/1</sup>	2/0 <sup>6/1</sup>	3/0 <sup>6/1</sup>
AWAC, ACAR		-	4 <sup>5/2, 6/1</sup>	2 <sup>5/2, 6/1, 3<sup>4/3, 5/2, 6/1, 4<sup>3/4, 4/3</sup></sup></sup>	1/0 <sup>6/1, 1<sup>5/2, 6/1, 2<sup>4/3, 3/4, 3<sup>2/5, 3/4, 4<sup>2/5</sup></sup></sup></sup></sup>	2/0 <sup>6/1, 1/0<sup>5/2, 4/3, 1<sup>3/4, 4/3, 2<sup>2/5</sup></sup></sup></sup>	3/0 <sup>6/1, 2/0<sup>5/2, 1/0<sup>3/4, 1<sup>2/5</sup></sup></sup></sup>
ALUMOWELD		8A, 8C	5A, 6A, 6C, 7A, 7D, 8D,	2F, 2G, 3A, 4A, 4N, 5D,	1/0 F, 1F, 1G, 1J, 2A, 2J,	2/0F, 1/0G,	3/0F, 2/0G, 2/0J,
COPPERWELD		3 No. 12	7 No. 12, 3 No. 9, 3 No. 10	6D, 3 No. 7, 3 No. 8, 7 No. 10, 7 No. 11	2K, 4D, 4P, 3 No. 5, 3 No. 6, 7 No. 8, 7 No. 9	1/0F, 1K, 2N, 7 No. 7	1/0K, 1N, 2P, 7 No. 6
Galvanized Steel		3/16"	1/4", 7/32"	5/16", 9/32"	3/8", 11/32"	7/16"	1/2"
Solid: AL or CU		5, 6	2, 3, 4	1/0, 1	2/0	3/0	250.0, 4/0

**Use TAP Number**      **1-602121-4\***      **1-602121-3\***      **1-602121-2\***      **1-602121-1\***      **1-602121-0\***      **602121-9\***











\*UL Listed

# Aluminum Taps











Large Wire Groove Code	54/7, 45/7, 26/7, 24/7, 36/1, 715.5 <sup>54/7, 30/19, 30/7, 26/7, 24/7</sup>	54/7, 45/7, 26/7, 24/7, 36/1, 715.5 <sup>54/7, 30/19, 30/7, 26/7, 24/7</sup>	54/7, 45/7, 26/7, 24/7, 36/1, 715.5 <sup>54/7, 30/19, 30/7, 26/7, 24/7</sup>			
ACSR Standard Round	795.0 <sup>54/7, 45/7, 26/7, 24/7, 36/1, 715.5<sup>54/7, 30/19, 30/7, 26/7, 24/7</sup></sup>	795.0 <sup>54/7, 45/7, 26/7, 24/7, 36/1, 715.5<sup>54/7, 30/19, 30/7, 26/7, 24/7</sup></sup>	795.0 <sup>54/7, 45/7, 26/7, 24/7, 36/1, 715.5<sup>54/7, 30/19, 30/7, 26/7, 24/7</sup></sup>	795.0 <sup>54/7, 45/7, 26/7, 24/7, 36/1, 715.5<sup>54/7, 30/19, 30/7, 26/7, 24/7</sup></sup>	795.0 <sup>54/7, 45/7, 26/7, 24/7, 36/1, 715.5<sup>54/7, 30/19, 30/7, 26/7, 24/7</sup></sup>	795.0 <sup>54/7, 45/7, 26/7, 24/7, 36/1, 715.5<sup>54/7, 30/19, 30/7, 26/7, 24/7</sup></sup>
AAAC 6201 - 5003	833.6, 927.2, 932.6	833.6, 927.2, 932.6	833.6, 927.2, 932.6	833.6, 927.2, 932.6	833.6, 927.2, 932.6	833.6, 927.2, 932.6
AAC Standard Round	795.0, 800.0, 874.5, 900.0	795.0, 800.0, 874.5, 900.0	795.0, 800.0, 874.5, 900.0	795.0, 800.0, 874.5, 900.0	795.0, 800.0, 874.5, 900.0	795.0, 800.0, 874.5, 900.0
COPPER Standard Round	800.0, 850.0, 900.0	800.0, 850.0, 900.0	800.0, 850.0, 900.0	800.0, 850.0, 900.0	800.0, 850.0, 900.0	800.0, 850.0, 900.0
AAC Compressed or Compacted	954.0	954.0	954.0	954.0	954.0	954.0
ACSR Compressed or Compacted	954.0 <sup>36/1</sup>	954.0 <sup>36/1</sup>	954.0 <sup>36/1</sup>	954.0 <sup>36/1</sup>	954.0 <sup>36/1</sup>	954.0 <sup>36/1</sup>
AWAC, ACAR	853.7, 927.2 <sup>30/7, 24/13, 18/19, 862.7<sup>18/19, 840.2<sup>24/13, 819.2<sup>30/7</sup></sup></sup></sup>	853.7, 927.2 <sup>30/7, 24/13, 18/19, 862.7<sup>18/19, 840.2<sup>24/13, 819.2<sup>30/7</sup></sup></sup></sup>	853.7, 927.2 <sup>30/7, 24/13, 18/19, 862.7<sup>18/19, 840.2<sup>24/13, 819.2<sup>30/7</sup></sup></sup></sup>	853.7, 927.2 <sup>30/7, 24/13, 18/19, 862.7<sup>18/19, 840.2<sup>24/13, 819.2<sup>30/7</sup></sup></sup></sup>	853.7, 927.2 <sup>30/7, 24/13, 18/19, 862.7<sup>18/19, 840.2<sup>24/13, 819.2<sup>30/7</sup></sup></sup></sup>	853.7, 927.2 <sup>30/7, 24/13, 18/19, 862.7<sup>18/19, 840.2<sup>24/13, 819.2<sup>30/7</sup></sup></sup></sup>
ALUMOWELD	-	-	-	-	-	-
COPPERWELD	-	-	-	-	-	-
Galvanized Steel	-	-	-	-	-	-
Solid: AL or CU	-	-	-	-	-	-
ACSR Standard Round	4/0 <sup>9/1, 134.6<sup>12/7</sup></sup>	266.8 <sup>26/7, 24/7, 18/1, 9/7, 300.0<sup>18/1, 159.0, 190.8, 176.9<sup>12/7</sup></sup></sup>	336.4 <sup>26/7, 24/7, 18/1, 300.0<sup>30/7, 26/7, 24/7, 266.8<sup>30/7, 211.3<sup>12/7, 203.2<sup>16/19</sup></sup></sup></sup></sup>	397.5 <sup>26/7, 24/7, 18/1, 336.4<sup>30/7</sup></sup>	477.0 <sup>26/7, 24/7, 18/1, 397.5<sup>30/7</sup></sup>	556.5 <sup>26/7, 18/1, 477.0, 500.0<sup>30/7</sup></sup>
AAAC 6201 - 5003	4/0	281.4, 307.1, 312.8	355.1, 394.5	419.6, 465.4, 466.3	503.6, 559.5, 599.6	587.2, 652.4, 652.8
AAC Standard Round	4/0	250.0, 266.8, 300.0	336.4, 350.0	397.5, 400.0, 450.0, 477.0	500.0, 550.0	556.5, 600.0
COPPER Standard Round	4/0	250.0, 300.0	350.0	400.0, 450.0	500.0, 550.0	600.0
AAC Compressed or Compacted	250.0, 266.8	300.0, 336.4, 350.0	397.5	477.0, 500.0, 556.5	636.0	-
ACSR Compressed or Compacted	266.8 <sup>18/1, 4/0<sup>9/1</sup></sup>	336.4 <sup>18/1</sup>	397.5 <sup>18/1</sup>	477.0, 556.6 <sup>18/1</sup>	-	636.0 <sup>18/1</sup>
AWAC, ACAR	4/0 <sup>6/1, 3/0<sup>4/3, 5/2, 2/0<sup>4/3, 3/4, 1/0<sup>2/5</sup></sup></sup></sup>	4/0 <sup>15/4</sup>	355.0 <sup>15/4, 12/7, 343.6<sup>15/4, 336.4<sup>16/3, 18/1</sup></sup></sup>	336.4 <sup>15/4</sup>	503.6 <sup>15/4, 12/7</sup>	653.1 <sup>15/4, 12/7, 568.3<sup>15/4</sup></sup>
ALUMOWELD	4/0F, 2/0K, 19 No. 10, 7 No. 5	4/0E, 4/0G, 19 No. 8, 19 No. 9, 7 No. 4	37 No. 10, 19 No. 7	37 No. 9	19 No. 6	37 No. 8, 19 No. 5
COPPERWELD	-	-	-	-	-	-
Galvanized Steel	9/16"	5/8"	-	3/4"	-	7/8"
Solid: AL or CU	266.8, 300.0	336.4, 350.0, 397.5, 400.0	450.0, 477.0, 500.0	-	-	-
<b>Use TAP Number</b>	<b>602121-8*</b>	<b>602121-7*</b>	<b>602121-6*</b>	<b>602121-5*</b>	<b>602121-4*</b>	<b>602121-3*</b>

\*UL Listed

## Aluminum Taps

Large Wire Groove Code							
ACSR Standard Round		795.0 <sup>54/7, 45/7, 26/7, 24/7, 36/1, 715.5<sup>54/7, 30/19, 30/7, 26/7, 24/7</sup></sup>	795.0 <sup>54/7, 45/7, 26/7, 24/7, 36/1, 715.5<sup>54/7, 30/19, 30/7, 26/7, 24/7</sup></sup>	795.0 <sup>54/7, 45/7, 26/7, 24/7, 36/1, 715.5<sup>54/7, 30/19, 30/7, 26/7, 24/7</sup></sup>	954.0 <sup>45/7, 36/1, 900.0<sup>54/7, 45/7, 874.5<sup>54/7, 795.0<sup>30/7, 30/19</sup></sup></sup></sup>	954.0 <sup>45/7, 36/1, 900.0<sup>54/7, 45/7, 874.5<sup>54/7, 795.0<sup>30/7, 30/19</sup></sup></sup></sup>	954.0 <sup>45/7, 36/1, 900.0<sup>54/7, 45/7, 874.5<sup>54/7, 795.0<sup>30/7, 30/19</sup></sup></sup></sup>
AAAC 6201 - 5003		833.6, 927.2, 932.6	833.6, 927.2, 932.6	833.6, 927.2, 932.6	-	-	-
AAC Standard Round		800.0 874.5, 900.0	795.0, 800.0 874.5, 900.0	800.0 874.5, 900.0	954.0, 1000.0	954.0, 1000.0	954.0, 1000.0
COPPER Standard Round		800.0 850.0, 900.0	800.0 850.0, 900.0	800.0 850.0, 900.0	1000.0	1000.0	1000.0
AAC Compressed or Compacted		954.0	954.0	954.0	-	-	-
ACSR Compressed or Compacted		954.0 <sup>36/1</sup>	954.0 <sup>36/1</sup>	954.0 <sup>36/1</sup>	-	-	-
AWAC, ACAR		853.7, 927.2 <sup>30/7, 24/13, 18/19, 862.7<sup>18/19, 840.2<sup>24/13, 819.2<sup>30/7</sup></sup></sup></sup>	853.7, 927.2 <sup>30/7, 24/13, 18/19, 862.7<sup>18/19, 840.2<sup>24/13, 819.2<sup>30/7</sup></sup></sup></sup>	853.7, 927.2 <sup>30/7, 24/13, 18/19, 862.7<sup>18/19, 840.2<sup>24/13, 819.2<sup>30/7</sup></sup></sup></sup>	1024.5 <sup>30/7, 24/13, 18/19, 1012.2<sup>24/13, 983.1<sup>30/7</sup></sup></sup>	1024.5 <sup>30/7, 24/13, 18/19, 1012.2<sup>24/13, 983.1<sup>30/7</sup></sup></sup>	1024.5 <sup>30/7, 24/13, 18/19, 1012.2<sup>24/13, 983.1<sup>30/7</sup></sup></sup>
ALUMOWELD		-	-	-	37 No. 6	37 No. 6	37 No. 6
COPPERWELD		-	-	-	-	-	-
Galvanized Steel		-	-	-	-	-	-
Solid: AL or CU		-	-	-	-	-	-



ACSR Standard Round		636.0 <sup>54/7, 26/7, 24/7, 36/1, 18/1, 605.0<sup>54/7, 26/7, 24/7, 30/19, 30/7, 556.5<sup>30/7, 653.9<sup>18/13</sup></sup></sup></sup>	715.5 <sup>54/7, 45/7, 26/7, 24/7, 795.0<sup>36/1, 666.6<sup>54/7, 26/7, 24/7, 636.0<sup>30/19, 30/7</sup></sup></sup></sup>	795.0 <sup>54/7, 45/7, 26/7, 24/7, 715.5<sup>30/19, 30/7</sup></sup>	6 <sup>6/1</sup>	4 <sup>7/1, 6/1, 5<sup>6/1</sup></sup>	1 <sup>6/1, 2<sup>7/1, 6/1</sup></sup>
AAAC 6201 - 5003		704.6	4/0	927.2	6	4, 5	1, 2, 3
AAC Standard Round		636.0, 650.0, 700.0, 795.0	4/0	795.0, 800.0 874.5, 900.0	5, 6	3, 4	1, 2
COPPER Standard Round		650.0, 700.0	4/0	-	5, 6	3, 4	1, 2
AAC Compressed or Compacted		795.0	250.0, 266.8	-	4, 6	2, 3	1/0, 1
ACSR Compressed or Compacted		795.0 <sup>36/1</sup>	266.8 <sup>18/1, 4/0<sup>6/1</sup></sup>	-	6 <sup>6/1</sup>	4 <sup>7/1, 6/1</sup>	1 <sup>6/1, 2<sup>7/1, 6/1</sup></sup>
AWAC, ACAR		-	4/0 <sup>6/1, 3/0<sup>4/3, 2/0<sup>4/3, 3/4, 1/0<sup>2/5</sup></sup></sup></sup>	853.7, 927.2 <sup>30/7, 24/13, 18/19, 862.7<sup>18/19, 840.2<sup>23/13</sup></sup></sup>	-	4 <sup>5/2, 6/1</sup>	1 <sup>6/1, 2<sup>4/3, 5/2, 6/1, 3<sup>3/4, 4/3, 5/2, 6/1, 4<sup>2/5, 3/4, 4/3</sup></sup></sup></sup>
ALUMOWELD		-	4/0F, 2/0K, 19 No. 10, 7 No. 5	-	8A, 8C, 3 No. 12	5A, 6A, 6C, 7A, 7D, 8D, 3 No. 9, 3 No. 10, 7 No. 11, 7 No. 12	1F, 2F, 2G, 2J, 3A, 4A, 4D, 4N, 5D, 6D, 3 No. 6, 3 No. 7, 3 No. 8, 7 No. 9, 7 No. 10
COPPERWELD		-	-	-	-	-	-
Galvanized Steel		-	9/16"	-	3/16"	7/32", 9/32", 1/4"	3/8", 5/16", 9/32", 11/32"
Solid: AL or CU		-	266.8, 300.0	-	4, 5, 6	2, 3	1/0, 1

Use TAP Number	602121*	1-602180-6*	1-602180-5*	1-602180-4*	1-602180-3*	1-602180-2*
----------------	---------	-------------	-------------	-------------	-------------	-------------

\*UL Listed



## Aluminum Taps

Large Wire Groove Code						
ACSR Standard Round	954.0 <sup>45/7, 36/1, 900.0<sup>54/7, 45/7, 874.5<sup>54/7, 795.0<sup>30/7, 30/19</sup></sup></sup></sup>	954.0 <sup>45/7, 36/1, 900.0<sup>54/7, 45/7, 874.5<sup>54/7, 795.0<sup>30/7, 30/19</sup></sup></sup></sup>	954.0 <sup>45/7, 36/1, 900.0<sup>54/7, 45/7, 874.5<sup>54/7, 795.0<sup>30/7, 30/19</sup></sup></sup></sup>	954.0 <sup>45/7, 36/1, 900.0<sup>54/7, 45/7, 874.5<sup>54/7, 795.0<sup>30/7, 30/19</sup></sup></sup></sup>	954.0 <sup>45/7, 36/1, 900.0<sup>54/7, 45/7, 874.5<sup>54/7, 795.0<sup>30/7, 30/19</sup></sup></sup></sup>	954.0 <sup>45/7, 36/1, 900.0<sup>54/7, 45/7, 874.5<sup>54/7, 795.0<sup>30/7, 30/19</sup></sup></sup></sup>
AAAC 6201 - 5003	-	-	-	-	-	-
AAC Standard Round	954.0, 1000.0	954.0, 1000.0	954.0, 1000.0	954.0, 1000.0	954.0, 1000.0	954.0, 1000.0
COPPER Standard Round	1000.0	1000.0	1000.0	1000.0	1000.0	1000.0
AAC Compressed or Compacted	-	-	-	-	-	-
ACSR Compressed or Compacted	-	-	-	-	-	-
AWAC, ACAR	1024.5 <sup>30/7, 24/13, 18/19, 1012.2<sup>24/13, 983.1<sup>30/7</sup></sup></sup>	1024.5 <sup>30/7, 24/13, 18/19, 1012.2<sup>24/13, 983.1<sup>30/7</sup></sup></sup>	1024.5 <sup>30/7, 24/13, 18/19, 1012.2<sup>24/13, 983.1<sup>30/7</sup></sup></sup>	1024.5 <sup>30/7, 24/13, 18/19, 1012.2<sup>24/13, 983.1<sup>30/7</sup></sup></sup>	1024.5 <sup>30/7, 24/13, 18/19, 1012.2<sup>24/13, 983.1<sup>30/7</sup></sup></sup>	1024.5 <sup>30/7, 24/13, 18/19, 1012.2<sup>24/13, 983.1<sup>30/7</sup></sup></sup>
ALUMOWELD	37 No. 6	37 No. 6	37 No. 6	37 No. 6	37 No. 6	37 No. 6
COPPERWELD						
Galvanized Steel	-	-	-	-	-	-
Solid: AL or CU	-	-	-	-	-	-



ACSR Standard Round	2/0 <sup>6/1, 1/0<sup>6/1, 80.0<sup>8/1</sup></sup></sup>	3/0 <sup>6/1, 101.8<sup>12/7</sup></sup>	4/0 <sup>6/1, 110.8, 134.6<sup>12/7</sup></sup>	266.8 <sup>18/1, 159.0, 176.9<sup>12/7</sup></sup>	336.4 <sup>26/7, 24/7, 18/1, 300.0<sup>30/7, 26/7, 24/7, 18/1, 266.8<sup>30/7, 26/7, 24/7, 6/7, 211.3<sup>12/7, 190.8<sup>12/7</sup></sup></sup></sup></sup>	397.5 <sup>18/1, 336.4<sup>30/7, 203.2<sup>16/19</sup></sup></sup>
AAAC 6201 - 5003	2/0, 1/0	3/0	4/0	281.4	307.1, 312.8, 355.1	394.5, 419.6
AAC Standard Round	2/0, 1/0	3/0	4/0	250.0, 266.8	300.0, 336.4, 350.0	397.5, 400.0
COPPER Standard Round	2/0, 1/0	3/0	4/0	250.0	300.0, 350.0	400.0
AAC Compressed or Compacted	2/0	3/0	250.0, 4/0	266.8, 300.0, 336.4	350.0, 397.5	477.0, 500.0
ACSR Compressed or Compacted	2/0, 1/0 <sup>6/1</sup>	3/0 <sup>6/1</sup>	4/0 <sup>6/1</sup>	266.8 <sup>18/1</sup>	336.4 <sup>18/1, 397.5<sup>18/1</sup></sup>	477.0 <sup>18/1</sup>
AWAC, ACAR	1/0 <sup>6/1, 1<sup>4/3, 5/2, 2<sup>3/4, 3<sup>2/5</sup></sup></sup></sup>	2/0 <sup>6/1, 1/0<sup>4/3, 5/2, 1<sup>3/4, 2<sup>2/5</sup></sup></sup></sup>	3/0 <sup>6/1, 5/2, 2/0<sup>4/3, 5/2, 1/0<sup>3/4, 1<sup>2/5</sup></sup></sup></sup>	4/0 <sup>15/4, 6/1, 3/0<sup>4/3, 2/0<sup>3/4, 1/0<sup>2/5</sup></sup></sup></sup>	336.4 <sup>18/1, 343.6<sup>15/4, 355.0<sup>15/4, 12/7</sup></sup></sup>	336.4 <sup>16/3, 15/4</sup>
ALUMOWELD	4P, 1/0F, 1/0G, 1G, 1J, 1K, 2A, 2K, 2N, 3 No. 5, 7 No. 8	2/0F, 2/0G, 1/0J, 1N, 2P, 7 No. 7	3/0F, 2/0J, 2/0K, 1/0K, 7 No. 6, 19 No. 10	4/0F, 4/0G, 7 No. 5, 19 No. 9	355.0 <sup>15/4, 12/7, 4/0E, 7 No. 4, 19 No. 8</sup>	19 No. 7 37 No. 10
COPPERWELD						
Galvanized Steel	-	7/16"	1/2"	9/16"	5/8"	-
Solid: AL or CU	3/0, 2/0	4/0	250.0, 266.8, 300.0	336.4, 350.0, 397.5	400.0, 450.0, 477.0	500.0

Use TAP Number	1-602180-3*	1-602180-2*	1-602180-1*	1-602180-0*	602180-9*	602180-8*
----------------	-------------	-------------	-------------	-------------	-----------	-----------

\*UL Listed

## Aluminum Taps

Large Wire Groove Code						
ACSR Standard Round	954.0 <sup>45/7, 36/1, 900.0<sup>54/7, 45/7, 874.5<sup>54/7, 795.0<sup>30/7, 30/19</sup></sup></sup></sup>	954.0 <sup>45/7, 36/1, 900.0<sup>54/7, 45/7, 874.5<sup>54/7, 795.0<sup>30/7, 30/19</sup></sup></sup></sup>	954.0 <sup>45/7, 36/1, 900.0<sup>54/7, 45/7, 874.5<sup>54/7, 795.0<sup>30/7, 30/19</sup></sup></sup></sup>	954.0 <sup>45/7, 36/1, 900.0<sup>54/7, 45/7, 874.5<sup>54/7, 795.0<sup>30/7, 30/19</sup></sup></sup></sup>	954.0 <sup>45/7, 36/1, 900.0<sup>54/7, 45/7, 874.5<sup>54/7, 795.0<sup>30/7, 30/19</sup></sup></sup></sup>	954.0 <sup>45/7, 36/1, 900.0<sup>54/7, 45/7, 874.5<sup>54/7, 795.0<sup>30/7, 30/19</sup></sup></sup></sup>
AAAC 6201 - 5003	-	-	-	-	-	-
AAC Standard Round	954.0, 1000.0	954.0, 1000.0	954.0, 1000.0	954.0, 1000.0	954.0, 1000.0	954.0, 1000.0
COPPER Standard Round	1000.0	1000.0	1000.0	1000.0	1000.0	1000.0
AAC Compressed or Compacted	-	-	-	-	-	-
ACSR Compressed or Compacted	-	-	-	-	-	-
AWAC, ACAR	1024.5 <sup>30/7, 24/13, 18/19, 1012.2<sup>24/13, 983.1<sup>30/7</sup></sup></sup>	1024.5 <sup>30/7, 24/13, 18/19, 1012.2<sup>24/13, 983.1<sup>30/7</sup></sup></sup>	1024.5 <sup>30/7, 24/13, 18/19, 1012.2<sup>24/13, 983.1<sup>30/7</sup></sup></sup>	1024.5 <sup>30/7, 24/13, 18/19, 1012.2<sup>24/13, 983.1<sup>30/7</sup></sup></sup>	1024.5 <sup>30/7, 24/13, 18/19, 1012.2<sup>24/13, 983.1<sup>30/7</sup></sup></sup>	1024.5 <sup>30/7, 24/13, 18/19, 1012.2<sup>24/13, 983.1<sup>30/7</sup></sup></sup>
ALUMOWELD	37 No. 6	37 No. 6	37 No. 6	37 No. 6	37 No. 6	37 No. 6
COPPERWELD	-	-	-	-	-	-
Galvanized Steel	-	-	-	-	-	-
Solid: AL or CU	-	-	-	-	-	-
ACSR Standard Round	477.0 <sup>26/7, 24/7, 18/1, 397.5<sup>30/7, 26/7, 24/7</sup></sup>	556.5 <sup>18/1, 477.0, 500.0<sup>30/7</sup></sup>	636.0 <sup>54/8, 36/1, 26/7, 24/7, 18/1, 605.0<sup>54/7, 30/7, 26/7, 24/7, 30/19, 556.6<sup>30/7, 26/7, 24/7, 653.9<sup>18/3</sup></sup></sup></sup>	715.0 <sup>45/7, 666.6<sup>54/7, 26/7, 24/7, 636.0<sup>30/19, 30/7</sup></sup></sup>	795.0 <sup>45/7, 36/1, 715.5<sup>54/7, 30/19, 30/7, 26/7, 24/7</sup></sup>	874.5 <sup>54/7, 45/7, 795.0<sup>54/7, 30/19, 30/7, 26/7, 24/7</sup></sup>
AAAC 6201 - 5003	465.4, 466.3, 503.6	559.5, 587.2, 599.6	652.4, 652.8, 704.6	740.8, 746.1	833.6	927.2, 932.6
AAC Standard Round	450.0, 477.0, 500.0	550.0, 556.5, 600.0	636.0, 650.0, 700.0	715.5, 750.0	795.0, 800.0, 874.5	900.0, 954.0
COPPER Standard Round	450.0, 500.0, 550.0	600.0	650.0, 700.0	750.0	800.0, 850.0	900.0
AAC Compressed or Compacted	556.5	636.0	795.0	874.5	954.0	-
ACSR Compressed or Compacted	556.5 <sup>18/1</sup>	636.0 <sup>18/1</sup>	795.0 <sup>36/1</sup>	874.5 <sup>36/1</sup>	954.0 <sup>36/1</sup>	-
AWAC, ACAR	503.6 <sup>15/4, 12/7</sup>	568.3 <sup>15/4</sup>	653.1 <sup>15/4, 12/7</sup>	739.8 <sup>33/4, 30/7, 24/13, 18/19</sup>	819.2 <sup>30/7, 840.2<sup>24/13, 853.7<sup>30/7, 24/13, 18/19, 862.7<sup>18/19, 927.2<sup>30/7, 24/13, 18/19</sup></sup></sup></sup></sup>	1024.5 <sup>30/7, 24/13, 18/19, 1012.2<sup>24/13, 983.1<sup>30/7</sup></sup></sup>
ALUMOWELD	19 No. 6, 37 No. 9	37 No. 8	19 No. 5	37 No. 7	-	37 No. 6
COPPERWELD	-	-	-	-	-	-
Galvanized Steel	3/4"	7/8"	-	1"	-	-
Solid: AL or CU	-	-	-	-	-	-

**Use TAP Number**      **602180-7\***      **602180-6\***      **602180-5\***      **602180-4\***      **602180-3\***      **602180-2\***

\*UL Listed

## Aluminum Taps

Large Wire Groove Code							
ACSR Standard Round		954.0 <sup>45/7, 36/1</sup> , 900.0 <sup>54/7, 45/7</sup> , 874.5 <sup>54/7</sup> , 795.0 <sup>30/7, 30/19</sup>	954.0 <sup>45/7, 36/1</sup> , 900.0 <sup>54/7, 45/7</sup> , 874.5 <sup>54/7</sup> , 795.0 <sup>30/7, 30/19</sup>	1033.5 <sup>54/7, 45/7, 36/1</sup> , 954.0 <sup>54/7, 30/7</sup>	1033.5 <sup>54/7, 45/7, 36/1</sup> , 954.0 <sup>54/7, 30/7</sup>	1033.5 <sup>54/7, 45/7, 36/1</sup> , 954.0 <sup>54/7, 30/7</sup>	1033.5 <sup>54/7, 45/7, 36/1</sup> , 954.0 <sup>54/7, 30/7</sup>
AAAC 6201 - 5003		-	-	-	-	-	-
AAC Standard Round		954.0, 1000.0	954.0, 1000.0	1033.5, 1110.0, 1113.0	1033.5, 1110.0, 1113.0	1033.5, 1110.0, 1113.0	1033.5, 1110.0, 1113.0
COPPER Standard Round		1000.0	1000.0	-	-	-	-
AAC Compressed or Compacted		-	-	-	-	-	-
ACSR Compressed or Compacted		-	-	-	-	-	-
AWAC, ACAR		1024.5 <sup>30/7, 24/13, 18/19</sup> , 1012.2 <sup>24/13</sup> , 983.1 <sup>30/7</sup>	1024.5 <sup>30/7, 24/13, 18/19</sup> , 1012.2 <sup>24/13</sup> , 983.1 <sup>30/7</sup>	1170.0 <sup>33/4, 30/7, 24/13, 18/19, 1081.0</sup> , 1109.0 <sup>30/7, 18/19, 24/13</sup>	1170.0 <sup>33/4, 30/7, 24/13, 18/19, 1081.0</sup> , 1109.0 <sup>30/7, 18/19, 24/13</sup>	1170.0 <sup>33/4, 30/7, 24/13, 18/19, 1081.0</sup> , 1109.0 <sup>30/7, 18/19, 24/13</sup>	1170.0 <sup>33/4, 30/7, 24/13, 18/19, 1081.0</sup> , 1109.0 <sup>30/7, 18/19, 24/13</sup>
ALUMOWELD		37 No. 6	37 No. 6	-	-	-	-
COPPERWELD		-	-	-	-	-	-
Galvanized Steel		-	-	-	-	-	-
Solid: AL or CU		-	-	-	-	-	-
ACSR Standard Round		1033.5 <sup>54/7, 45/7, 36/1, 954.0<sup>54/7, 45/7, 36/1, 30/7, 900.0<sup>54/7, 45/7</sup></sup></sup>	1033.5 <sup>54/7, 45/7, 36/1, 954.0<sup>30/7</sup></sup>	6 <sup>6/1</sup>	4 <sup>7/1, 6/1, 5<sup>6/1</sup></sup>	2 <sup>7/1, 6/1, 3<sup>6/1</sup></sup>	1/0 <sup>6/1, 1<sup>6/1, 80.0<sup>8/1</sup></sup></sup>
AAAC 6201 - 5003		-	-	6	4, 5	2, 3	1/0, 1
AAC Standard Round		1000.0, 1033.5, 1100.0, 1113.0	1100.0, 1113.0	6	4, 5	2, 3	1/0, 1
COPPER Standard Round		1000.0	-	6	4, 5	2, 3	1/0, 1
AAC Compressed or Compacted		-	-	6	3, 4	1, 2	1/0
ACSR Compressed or Compacted		-	-	6 <sup>6/1</sup>	4 <sup>7/1, 6/1</sup>	2 <sup>7/1, 6/1</sup>	1/0 <sup>6/1, 1<sup>6/1</sup></sup>
AWAC, ACAR		1172.0 <sup>33/4, 30/7, 24/13, 18/19, 1081.0, 1109.0<sup>30/7, 24/13, 18/19</sup></sup>	1172.0 <sup>33/4, 30/7, 24/13, 18/19, 1109.0<sup>30/7, 24/13, 18/19</sup></sup>	-	-	2 <sup>6/1, 3<sup>4/3, 5/2, 6/1, 4<sup>3/4, 4/3, 5/2, 6/1</sup></sup></sup>	1 <sup>5/2, 6/1, 2<sup>4/3, 5/2, 3<sup>3/4, 4<sup>5/2</sup></sup></sup></sup>
ALUMOWELD		-	-	8A, 8C, 3 No. 12	6A, 6C, 7A, 7D, 8D, 3 No. 9, 3 No. 10, 7 No. 12	2F, 4A, 5A, 5D, 6D, 3 No. 7, 3 No. 8, 7 No. 10, 7 No. 11	1F, 1G, 2A, 2G, 2J, 2K, 3A, 4D, 4N, 4P, 3 No.6 7 No. 9
COPPERWELD		-	-	-	-	1/4", 7/32", 3/16"	5/16", 9/32"
Galvanized Steel		-	-	-	-	1/4", 7/32", 3/16"	5/16", 9/32"
Solid: AL or CU		-	-	5, 6	2, 3, 4	1/0, 1	2/0
<b>Use TAP Number</b>	<b>602180-1*</b>	<b>602180*</b>	<b>1-602180-6*</b>	<b>1-602180-5*</b>	<b>1-602180-4*</b>	<b>1-602180-3*</b>	















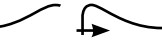

















\*UL Listed

## Aluminum Taps

Large Wire Groove Code							
ACSR Standard Round		1033.5 <sup>54/7</sup> , 45/7, 36/1, 954.0 <sup>54/7, 30/7</sup>	1033.5 <sup>54/7</sup> , 45/7, 36/1, 954.0 <sup>54/7, 30/7</sup>	1033.5 <sup>54/7</sup> , 45/7, 36/1, 954.0 <sup>54/7, 30/7</sup>	1033.5 <sup>54/7</sup> , 45/7, 36/1, 954.0 <sup>54/7, 30/7</sup>	1033.5 <sup>54/7</sup> , 45/7, 36/1, 954.0 <sup>54/7, 30/7</sup>	
AAAC 6201 - 5003		-	-	-	-	-	
AAC Standard Round		1033.5, 1110.0, 1113.0	1033.5, 1110.0, 1113.0	1033.5, 1110.0, 1113.0	1033.5, 1110.0, 1113.0	1033.5, 1110.0, 1113.0	
COPPER Standard Round		-	-	-	-	-	
AAC Compressed or Compacted		-	-	-	-	-	
ACSR Compressed or Compacted		-	-	-	-	-	
AWAC, ACAR		1172.0 <sup>33/4</sup> , 30/7, 24/13, 18/19, 1081.0, 1109.0 <sup>30/7, 24/13</sup> , 18/19	1172.0 <sup>33/4</sup> , 30/7, 24/13, 18/19, 1081.0, 1109.0 <sup>30/7, 24/13</sup> , 18/19	1170.0 <sup>33/4</sup> , 30/7, 24/13, 18/19, 1081.0, 1109.0 <sup>30/7, 24/13</sup> , 18/19	1170.0 <sup>33/4</sup> , 30/7, 24/13, 18/19, 1081.0, 1109.0 <sup>30/7, 18/19</sup> , 24/13	1170.0 <sup>33/4</sup> , 30/7, 24/13, 18/19, 1081.0, 1109.0 <sup>30/7, 24/13</sup> , 18/19	
ALUMOWELD		-	-	-	-	-	
COPPERWELD		-	-	-	-	-	
Galvanized Steel		-	-	-	-	-	
Solid: AL or CU		-	-	-	-	-	
ACSR Standard Round		2/0 <sup>6/1</sup>	3/0 <sup>6/1</sup> , 101.8 <sup>12/7</sup>	4/0 <sup>6/1</sup> , 110.8, 134.6 <sup>12/7</sup>	266.8 <sup>26/7, 24/7</sup> , 18/1, 6/7, 159.0, 176.9, 190.8 <sup>12/7</sup>	336.4 <sup>26/7, 24/7</sup> , 18/1, 300.0 <sup>30/7</sup> , 26/7, 24/7, 18/1, 266.8 <sup>30/7</sup> , 211.3 <sup>12/7</sup> , 203.2 <sup>16/19</sup>	397.5 <sup>26/7, 24/7</sup> , 18/1, 336.4 <sup>30/7</sup>
AAAC 6201 - 5003		2/0	3/0	4/0	281.4, 307.1, 312.8	355.1, 394.5	419.6, 465.4, 466.3
AAC Standard Round		2/0	3/0	4/0	250.0, 266.8, 300.0	336.4, 350.0	397.5, 400.0, 450.0
COPPER Standard Round		2/0	3/0	4/0	250.0, 300.0	350.0	350.0, 400.0, 450.0
AAC Compressed or Compacted		2/0	3/0	250.0, 266.8 4/0	300.0, 336.4, 350.0	397.5	477.0, 500.0, 556.5
ACSR Compressed or Compacted		2/0 <sup>6/1</sup>	3/0 <sup>6/1</sup>	4/0 <sup>6/1</sup>	266.8 <sup>18/1</sup> , 336.4 <sup>18/1</sup>	397.5 <sup>18/1</sup>	477.0 <sup>18/1</sup>
AWAC, ACAR		1/0 <sup>5/2, 6/1, 14/3</sup> , 2 <sup>3/4</sup> , 3 <sup>2/5</sup>	3/0 <sup>6/1, 2/0<sup>6/1</sup></sup> , 5/2, 4/3, 1/0 <sup>4/3</sup> , 3/4, 1 <sup>3/4</sup> , 2 <sup>1/5</sup> , 2 <sup>2/5</sup>	4/0 <sup>6/1, 3/0<sup>4/3</sup></sup> , 5/2, 2/0 <sup>3/4</sup> , 1/0 <sup>2/5</sup>	4/0 <sup>15/4</sup>	343.6 <sup>15/4</sup> , 336.4 <sup>18/1, 16/3</sup>	336.4 <sup>15/4</sup>
ALUMOWELD		1/0F, 1/0G, 1J, 1K, 2N, 3 No.5, 7 No. 8	2/0, 2/0G, 2/0F, 1/0K, 1/0J, 1N, 2P, 7 No. 6, 7 No. 7	4/0F, 3/0F, 2/0K, 7 No. 5, 19 No. 10	4/0E, 4/0G, 7 No. 4, 19. No. 9	19 No. 8	19 No. 7, 37 No. 10
COPPERWELD		-	1/2", 7/16"	7/16"	5/8"	-	3/4"
Galvanized Steel		-	1/2", 7/16"	7/16"	5/8"	-	3/4"
Solid: AL or CU		3/0	4/0	250.0, 266.8, 300.0	336.4, 350.0, 397.5, 400.0	450.0, 477.0	500.0
<b>Use TAP Number</b>	<b>1-602180-2*</b>	<b>1-602180-1*</b>	<b>1-602180-0*</b>	<b>602180-9*</b>	<b>602180-8*</b>	<b>602180-7*</b>	

\*UL Listed

## Aluminum Taps

Large Wire Groove Code						
ACSR Standard Round	 1033.5 <sup>54/7</sup> , 45/7, 36/1, 954.0 <sup>54/7, 30/7</sup>	1033.5 <sup>54/1</sup> , 45/7, 36/7, 954.0 <sup>54/7, 30/7</sup>	1033.5 <sup>54/7</sup> , 45/7, 36/1, 954.0 <sup>54/7, 30/7</sup>	1033.5 <sup>54/7</sup> , 45/7, 36/1, 954.0 <sup>54/7, 30/7</sup>	1033.5 <sup>54/7</sup> , 45/7, 36/1, 954.0 <sup>54/7, 30/7</sup>	1033.5 <sup>54/7</sup> , 45/7, 36/1, 954.0 <sup>54/7, 30/7</sup>
AAAC 6201 - 5003	 -	-	-	-	-	-
AAC Standard Round	 1033.5, 1110.0, 1113.0	1033.5, 1110.0, 1113.0	1033.5, 1110.0, 1113.0	1033.5, 1110.0, 1113.0	1033.5, 1110.0, 1113.0	1033.5, 1110.0, 1113.0
COPPER Standard Round	 -	-	-	-	-	-
AAC Compressed or Compacted	 -	-	-	-	-	-
ACSR Compressed or Compacted	 -	-	-	-	-	-
AWAC, ACAR	 1172.0 <sup>33/4</sup> , 30/7, 24/13, 18/19, 1081.0, 1109.0 <sup>30/7, 24/13</sup> , 18/19	1170.0 <sup>33/4</sup> , 30/7, 24/13, 18/19, 1081.0, 1109.0 <sup>30/7, 24/13</sup> , 18/19	1170.0 <sup>33/4</sup> , 30/7, 24/13, 18/19, 1081.0, 1109.0 <sup>30/7, 18/19</sup> , 24/13	1170.0 <sup>33/4</sup> , 30/7, 24/13, 18/19, 1081.0, 1109.0 <sup>30/7, 18/19</sup> , 24/13	1170.0 <sup>33/4</sup> , 30/7, 24/13, 18/19, 1081.0, 1109.0 <sup>30/7, 18/19</sup> , 24/13	1172.0 <sup>33/4</sup> , 30/7, 24/13, 18/19, 1081.0, 1109.0 <sup>30/7, 24/13</sup> , 18/19
ALUMOWELD	 -	-	-	-	-	-
COPPERWELD	 -	-	-	-	-	-
Galvanized Steel	 -	-	-	-	-	-
Solid: AL or CU	 -	-	-	-	-	-
						
ACSR Standard Round	 477.0 <sup>26/7</sup> , 24/7, 18/1, 397.5 <sup>30/7</sup>	556.5 <sup>26/7</sup> , 24/7, 18/1, 477.0, 500.0 <sup>30/7</sup>	636.0 <sup>54/7, 26/7</sup> , 24/7, 36/1, 18/1, 605.0 <sup>54/7, 30/7</sup> , 26/7, 24/7, 30/19, 556.5 <sup>30/7</sup> , 653.9 <sup>18/3</sup>	715.5 <sup>54/7</sup> , 45/7, 26/7, 24/7, 666.6 <sup>54/7</sup> , 26/7, 24/7, 636.0 <sup>30/19</sup> , 30/7	795.0 <sup>54/7</sup> , 45/7, 36/1, 26/7, 24/7, 715.5 <sup>30/7</sup> , 30/19	954.0 <sup>45/7, 36/1</sup> , 900.0 <sup>54/7, 45/7</sup> , 874.5, 795.0 <sup>54/7</sup> , 30/7, 30/19, 26/7, 24/7
AAAC 6201 - 5003	 503.6, 559.5, 599.6	587.2, 652.4, 652.8	704.6	740.8, 746.1	833.6	927.2, 932.6
AAC Standard Round	 477.0, 500.0 550.0, 556.5	600.0	636.0, 650.0, 700.0	715.5, 750.0	795.0, 800.0, 874.5	900.0, 954.0, 1000.0
COPPER Standard Round	 500.0, 550.0	600.0	650.0, 700.0	750.0	800.0, 850.0	900.0, 1000.0
AAC Compressed or Compacted	 556.5, 636.0	-	795.0	874.5	954.0	-
ACSR Compressed or Compacted	 556.5 <sup>18/1</sup>	636.0 <sup>18/1</sup>	795 <sup>36/1</sup>	874.5 <sup>36/1</sup>	954.0 <sup>36/1</sup>	-
AWAC, ACAR	 503.6 <sup>15/4, 12/7</sup>	568.3 <sup>15/4</sup>	653.1 <sup>15/4, 12/7</sup>	739.8 <sup>33/4, 30/7</sup> , 24/13, 18/19	862.7 <sup>18/19</sup> , 853.7 <sup>30/7, 24/13</sup> , 18/19, 840.2 <sup>24/13</sup> , 819.2 <sup>30/7</sup>	927.2, 1024.5 <sup>30/7, 24/13</sup> , 18/19, 1012.2 <sup>24/13</sup> , 983.1 <sup>30/7</sup>
ALUMOWELD	 19 No. 6, 37 No. 9	37 No. 8	19 No. 5	37 No. 7	-	37 No. 6
COPPERWELD	 -	-	-	-	-	-
Galvanized Steel	 -	7/8"	-	1"	-	-
Solid: AL or CU	 -	-	-	-	-	-
<b>Use TAP Number</b>	<b>602180-6*</b>	<b>602180-5*</b>	<b>602180-4*</b>	<b>602180-3*</b>	<b>602180-2*</b>	<b>602180-1*</b>

\*UL Listed

# Aluminum Taps

Large Wire Groove Code						
ACSR Standard Round	1033.5 <sup>54/7, 45/7, 36/1, 954.0<sup>54/7, 30/7</sup></sup>	1113.0 <sup>45/7, 54/19, 1192.5<sup>36/1, 45/7</sup></sup>	1113.0 <sup>45/7, 54/19, 1192.5<sup>36/1, 45/7</sup></sup>	1113.0 <sup>45/7, 54/19, 1192.5<sup>36/1, 45/7</sup></sup>	1113.0 <sup>45/7, 54/19, 1192.5<sup>36/1, 45/7</sup></sup>	1113.0 <sup>45/7, 54/19, 1192.5<sup>36/1, 45/7</sup></sup>
AAAC 6201 - 5003	-	-	-	-	-	-
AAC Standard Round	1033.5, 1110.0, 1113.0	1033.5, 1110.0, 1113.0	1192.5, 1200.0, 1250.0, 1272.0	1192.5, 1200.0, 1250.0, 1272.0	1192.5, 1200.0, 1250.0, 1272.0	1192.5, 1200.0, 1250.0, 1272.0
COPPER Standard Round	-	-	-	-	-	-
AAC Compressed or Compacted	-	-	-	-	-	-
ACSR Compressed or Compacted	-	-	-	-	-	-
AWAC, ACAR	1172.0 <sup>33/4, 30/7, 24/13, 18/19, 1081.0, 1109.0<sup>30/7, 24/13, 18/19</sup></sup>	-	-	-	-	-
ALUMOWELD	-	-	-	-	-	-
COPPERWELD	-	-	-	-	-	-
Galvanized Steel	-	-	-	-	-	-
Solid: AL or CU	-	-	-	-	-	-

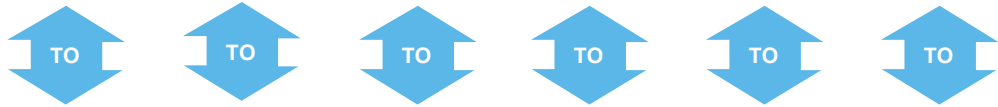















ACSR Standard Round	1033.5 <sup>54/7, 45/7, 36/1, 954.0<sup>54/7, 30/7</sup></sup>	6 <sup>6/1</sup>	5 <sup>6/1, 4<sup>7/1, 6/1</sup></sup>	3 <sup>6/1, 2<sup>7/1, 6/1</sup></sup>	1/0 <sup>6/1, 1<sup>6/1, 80.0<sup>6/1</sup></sup></sup>	2/0 <sup>6/1</sup>
AAAC 6201 - 5003	-	6	4, 5	2, 3	1/0, 1	2/0
AAC Standard Round	1033.5, 1110.0, 1113.0	6	3, 4, 5	1, 2	1/0	2/0
COPPER Standard Round	-	6	3, 4, 5	2	1/0, 1	2/0
AAC Compressed or Compacted	-	6	3, 4	1, 2	1/0, 2/0	3/0
ACSR Compressed or Compacted	-	6 <sup>6/1</sup>	4 <sup>7/1, 6/1</sup>	2 <sup>7/1, 6/1, 1<sup>6/1</sup></sup>	1/0 <sup>6/1</sup>	2/0 <sup>6/1</sup>
AWAC, ACAR	1172.0 <sup>33/4, 30/7, 24/13, 18/19, 1081.0, 1109.0<sup>30/7, 24/13, 18/19</sup></sup>	-	4 <sup>6/1, 5/2</sup>	4 <sup>3/4, 4/3, 3<sup>4/3, 5/2, 6/1, 2<sup>6/1, 5/2</sup></sup></sup>	4 <sup>2/5, 3<sup>3/4, 2/5, 2<sup>4/3, 3/4, 1<sup>6/1, 5/2, 4/3, 1/0<sup>6/1</sup></sup></sup></sup></sup>	2 <sup>2/5, 1<sup>3/4, 1/0<sup>5/2, 4/3, 2/0<sup>6/1</sup></sup></sup></sup>
ALUMOWELD	-	8A, 8C, 3 No. 12	5A, 6A, 6C, 7A, 7D, 8D, 3 No. 9, 3 No. 10, 7 No. 12	2F, 2G, 3A, 4A, 4N, 3 No. 7, 3 No. 8, 7 No. 10, 7 No. 11	4D, 4P, 2A, 2J, 2K, 1F, 1G, 1/0F, 2 No. 5, 2 No. 6, 7 No. 8, 7 No. 9	1J, 1K, 2N, 1/0G, 1/0J, 2/0F, 7 No. 7
COPPERWELD	-	8A, 8C, 3 No. 12	5A, 6A, 6C, 7A, 7D, 8D, 3 No. 9, 3 No. 10, 7 No. 12	2F, 2G, 3A, 4A, 4N, 3 No. 7, 3 No. 8, 7 No. 10, 7 No. 11	4D, 4P, 2A, 2J, 2K, 1F, 1G, 1/0F, 2 No. 5, 2 No. 6, 7 No. 8, 7 No. 9	1J, 1K, 2N, 1/0G, 1/0J, 2/0F, 7 No. 7
Galvanized Steel	-	5/16"	1/4", 7/32"	5/16", 9/32"	11/32", 3/8"	7/16"
Solid: AL or CU	-	5, 6	2, 3, 4	1/0, 1	2/0	2/0, 3/0









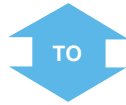

<b>Use TAP Number</b>	<b>602180*</b>	<b>1-602300-7</b>	<b>1-602300-6</b>	<b>1-602300-5</b>	<b>1-602300-4</b>	<b>1-602300-3</b>
-----------------------	----------------	-------------------	-------------------	-------------------	-------------------	-------------------

\*UL Listed

## Aluminum Taps

Large Wire Groove Code					
ACSR Standard Round 	1113.0 <sup>45</sup> / <sub>7</sub> , 54/19, 1192.5 <sup>36</sup> / <sub>1</sub> , 45/7	1113.0 <sup>45</sup> / <sub>7</sub> , 54/19, 1192.5 <sup>36</sup> / <sub>1</sub> , 45/7	1113.0 <sup>45</sup> / <sub>7</sub> , 54/19, 1192.5 <sup>36</sup> / <sub>1</sub> , 45/7	1113.0 <sup>45</sup> / <sub>7</sub> , 54/19, 1192.5 <sup>36</sup> / <sub>1</sub> , 45/7	1113.0 <sup>45</sup> / <sub>7</sub> , 54/19, 1192.5 <sup>36</sup> / <sub>1</sub> , 45/7
AAAC 6201 - 5003 	-	-	-	-	-
AAC Standard Round 	1192.5, 1200.0, 1250.0, 1272.0	1192.5, 1200.0, 1250.0, 1272.0	1192.5, 1200.0, 1250.0, 1272.0	1192.5, 1200.0, 1250.0, 1272.0	1192.5, 1200.0, 1250.0, 1272.0
COPPER Standard Round 	-	-	-	-	-
AAC Compressed or Compacted 	-	-	-	-	-
ACSR Compressed or Compacted 	-	-	-	-	-
AWAC, ACAR 	-	-	-	-	-
ALUMOWELD 	-	-	-	-	-
COPPERWELD	-	-	-	-	-
Galvanized Steel 	-	-	-	-	-
Solid: AL or CU 	-	-	-	-	-



























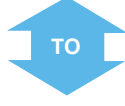





ACSR Standard Round 	3/0 <sup>6</sup> / <sub>1</sub> , 101.8, 110.8	4/0 <sup>6</sup> / <sub>1</sub> , 134.6, 159.0 <sup>12</sup> / <sub>7</sub>	176.9, 190.8 <sup>12</sup> / <sub>7</sub> , 266/8 <sup>18</sup> / <sub>1</sub> , <sup>24</sup> / <sub>7</sub> , <sup>6</sup> / <sub>7</sub> , <sup>26</sup> / <sub>7</sub> , <sup>30</sup> / <sub>7</sub> , 300.0 <sup>18</sup> / <sub>1</sub>	203.2 <sup>16</sup> / <sub>19</sub> , 211.3 <sup>12</sup> / <sub>7</sub> , 266.8 <sup>30</sup> / <sub>7</sub> , 300.0 <sup>30</sup> / <sub>7</sub> , <sup>26</sup> / <sub>7</sub> , <sup>24</sup> / <sub>7</sub> , 336.4 <sup>18</sup> / <sub>1</sub> , <sup>24</sup> / <sub>7</sub> , <sup>26</sup> / <sub>7</sub>	336.4 <sup>30</sup> / <sub>7</sub> , 397.5 <sup>18</sup> / <sub>1</sub> , <sup>24</sup> / <sub>7</sub> , <sup>26</sup> / <sub>7</sub>
AAAC 6201 - 5003 	3/0	4/0	281.4, 312.8, 307.1	355.1, 394.5	419.6, 465.4
AAC Standard Round 	3/0	4/0, 250.0	266.8, 300.0	336.4, 350.0, 397.5, 450.0, 477.0, 500.0	400.0, 450.0
COPPER Standard Round 	3/0	4/0, 250.0	300.0	350.0	400.0, 450.0
AAC Compressed or Compacted 	4/0	250.0, 266.8	336.4, 350.0	397.5, 477.0	500.0, 556.5
ACSR Compressed or Compacted 	3/0 <sup>6</sup> / <sub>1</sub>	4/0, 266.8 <sup>6</sup> / <sub>1</sub>	336.4 <sup>18</sup> / <sub>1</sub>	397.5 <sup>18</sup> / <sub>1</sub>	477.0 <sup>18</sup> / <sub>1</sub>
AWAC, ACAR 	1 <sup>2</sup> / <sub>5</sub> , 1/0 <sup>3</sup> / <sub>4</sub> , 2 <sup>2</sup> / <sub>5</sub> , 2/0 <sup>5</sup> / <sub>2</sub> , 4 <sup>4</sup> / <sub>3</sub> , 3/0 <sup>6</sup> / <sub>1</sub>	1/0 <sup>2</sup> / <sub>5</sub> , 2/0 <sup>3</sup> / <sub>4</sub> , 3/0 <sup>4</sup> / <sub>3</sub> , <sup>5</sup> / <sub>2</sub> , 4/0 <sup>6</sup> / <sub>1</sub> , <sup>15</sup> / <sub>4</sub>	-	336.4 <sup>18</sup> / <sub>1</sub> , <sup>16</sup> / <sub>3</sub> , <sup>15</sup> / <sub>4</sub> , 355.0 <sup>15</sup> / <sub>4</sub> , <sup>12</sup> / <sub>7</sub> , 343.6 <sup>15</sup> / <sub>4</sub>	-
ALUMOWELD 	1/0N, 1/0K, 2/0J,	2/0K, 4/0EK, 4/0F, 4/0G, 7	4/0E, 4/0G, 7 No. 4, 19. No. 8	19 No. 7, 37 No. 10	-
COPPERWELD	2/0G, 3/0F, 7 No. 6	No. 5, 19 No. 9, 19 No. 10			
Galvanized Steel 	1/2"	9/16"	5/8"	-	3/4"
Solid: AL or CU 	4/0, 250.0	266.8, 300.0	350.0, 397.5, 400.0	-	-

Use TAP Number	1-602300-2	1-602300-1	1-602300-0	602300-9	602300-8
----------------	------------	------------	------------	----------	----------

\*UL Listed



## Aluminum Taps

Large Wire Groove Code					
ACSR Standard Round 	1113.0 <sup>45/7, 54/19</sup> , 1192.5 <sup>36/1, 45/7</sup>	1113.0 <sup>45/7, 54/19</sup> , 1192.5 <sup>36/1, 45/7</sup>	1113.0 <sup>45/7, 54/19</sup> , 1192.5 <sup>36/1, 45/7</sup>	1113.0 <sup>45/7, 54/19</sup> , 1192.5 <sup>36/1, 45/7</sup>	1113.0 <sup>45/7, 54/19</sup> , 1192.5 <sup>36/1, 45/7</sup>
AAAC 6201 - 5003 	–	–	–	–	–
AAC Standard Round 	1192.5, 1200.0, 1250.0, 1272.0	1192.5, 1200.0, 1250.0, 1272.0	1192.5, 1200.0, 1250.0, 1272.0	1192.5, 1200.0, 1250.0, 1272.0	1192.5, 1200.0, 1250.0, 1272.0
COPPER Standard Round 	–	–	–	–	–
AAC Compressed or Compacted 	–	–	–	–	–
ACSR Compressed or Compacted 	–	–	–	–	–
AWAC, ACAR 	–	–	–	–	–
ALUMOWELD 	–	–	–	–	–
COPPERWELD 	–	–	–	–	–
Galvanized Steel 	–	–	–	–	–
Solid: AL or CU 	–	–	–	–	–
					
ACSR Standard Round 	397.5 <sup>30/7</sup> , 477.0 <sup>18/1, 24/7</sup> , 26/7	477.0, 500.0 <sup>30/7</sup> , 556.5 <sup>18/1</sup> , 24/7, 26/7	556.6 <sup>30/7</sup> , 605.0 <sup>24/7, 54/7</sup> , 26/7, 30/7, 30/19, 636.0 <sup>36/1, 18/1</sup> , 54/7, 26/7, 24/7, 653.9 <sup>18/3</sup>	636.0 <sup>30/7, 30/19</sup> , 666.6 <sup>24/7</sup> , 54/7, 26/7, 715.5 <sup>24/7</sup> , 54/7, 45/7, 26/7, 795.0 <sup>36/1</sup>	715.5 <sup>30/7, 30/19</sup> , 795.0 <sup>45/7</sup> , 24/7, 54/7, 26/7, 874.5 <sup>45/7</sup>
AAAC 6201 - 5003 	503.6, 559.5	587.2, 652.4	704.6, 740.8, 746.1	833.6	927.2, 932.6
AAC Standard Round 	477.0, 500.0, 550.0, 556.6	600.0, 636.0, 650.0	700.0, 715.5	750.0, 795.0, 800.0	874.5, 900.0, 954.0
COPPER Standard Round 	500.0, 550.0	600.0, 650.0	700.0	750.0, 800.0	850.0, 900.0
AAC Compressed or Compacted 	636.0	–	795.0, 874.5	954.0	–
ACSR Compressed or Compacted 	556.5, 636.0 <sup>18/1</sup>	–	795.0, 874.5 <sup>36/1</sup>	954.0 <sup>36/1</sup>	–
AWAC, ACAR 	503.6 <sup>15/4, 12/7</sup>	568.3 <sup>15/4</sup> , 653.1 <sup>15/4, 12/7</sup>	739.8 <sup>33/4, 30/7</sup> , 24/13, 18/19	819.2 <sup>30/7</sup>	840.2 <sup>24/13</sup> , 862.7 <sup>18/19</sup> , 853.7, 927.2 <sup>30/7</sup> , 24/13, 18/19
ALUMOWELD 	19 No. 6, 37 No. 9	19 No. 5, 37 No. 8	–	37 No. 7	–
COPPERWELD 	–	–	–	–	–
Galvanized Steel 	–	7/8"	–	1"	–
Solid: AL or CU 	–	–	–	–	–
<b>Use TAP Number</b>	<b>602300-7</b>	<b>602300-6</b>	<b>602300-5</b>	<b>602300-4</b>	<b>602300-3</b>

\*UL Listed



## Aluminum Taps

Large Wire Groove Code			
ACSR Standard Round	1113.0 <sup>45/7, 54/19</sup> , 1192.5 <sup>36/1, 45/7</sup>	1113.0 <sup>45/7, 54/19</sup> , 1192.5 <sup>36/1, 45/7</sup>	1113.0 <sup>45/7, 54/19</sup> , 1192.5 <sup>36/1, 45/7</sup>
AAAC 6201 - 5003	—	—	—
AAC Standard Round	1192.5, 1200.0, 1250.0, 1272.0	1192.5, 1200.0, 1250.0, 1272.0	1192.5, 1200.0, 1250.0, 1272.0
COPPER Standard Round	—	—	—
AAC Compressed or Compacted	—	—	—
ACSR Compressed or Compacted	—	—	—
AWAC, ACAR	—	—	—
ALUMOWELD	—	—	—
COPPERWELD	—	—	—
Galvanized Steel	—	—	—
Solid: AL or CU	—	—	—



ACSR Standard Round	795.0 <sup>30/7, 30/19</sup> , 874.5 <sup>54/7</sup> , 900.0 <sup>45/7, 54/7</sup> , 954.0 <sup>36/1, 45/7</sup> , 48/7	900.0 <sup>30/7</sup> , 954.0 <sup>54/7, 30/7</sup> , 1013.5 <sup>36/1, 45/7</sup> , 48/7, 54/7	1113.0 <sup>45/7</sup> , 54/19, 1192.5 <sup>36/1</sup> , 45/7
AAAC 6201 - 5003	—	—	—
AAC Standard Round	1000.0, 1033.5	1100.0, 1113.0	1192.5, 1200.0, 1250.0, 1272.0
COPPER Standard Round	1000.0	—	—
AAC Compressed or Compacted	—	—	—
ACSR Compressed or Compacted	—	—	—
AWAC, ACAR	983.1 <sup>30/7</sup> , 1012.2 <sup>24/13</sup> , 1024.5 <sup>30/7, 24/13</sup> , 18/19	1081.0, 1109.0 <sup>30/7, 24/13</sup> , 30/7, 1172.0 <sup>33/4</sup> , 30/7, 24/13, 18/19	—
ALUMOWELD	37 No. 6	—	—
COPPERWELD	—	—	—
Galvanized Steel	—	—	—
Solid: AL or CU	—	—	—

<b>Use TAP Number</b>	<b>602300-2</b>	<b>602300-1</b>	<b>602300</b>
-----------------------	-----------------	-----------------	---------------

\*UL Listed



### Copper Taps







Wire ID Code	-	-	-	-	-	-	-
Copper Std. Round	8	6	6	4	1/0	1/0	4
Copper Compressed	-	-	-	-	-	-	-
Copper Compacted	-	-	-	-	-	-	-
Copper Solid	8, 6	4	4	2	-	-	2
COPPERWELD	-	-	-	-	-	-	-
Ground Rod	-	-	-	-	-	-	-
Pin Diameter	-	-	-	-	-	-	-
Copper Std. Round	8	8	6	8, 6	8, 6	4, 2	4
Copper Compressed	-	-	-	-	-	-	-
Copper Compacted	-	4	-	-	-	-	-
Copper Solid	8, 6	8	6, 4	8, 6	8, 6, 4	2	4, 2
COPPERWELD	-	-	-	-	-	-	-
Ground Rod	-	-	-	-	-	-	-
Pin Diameter	-	-	-	-	-	-	-
<b>Use Tap Number</b>	<b>277060-5**</b>	<b>277060-5**</b>	<b>277060-4**</b>	<b>277060-4**</b>	<b>277060-2**</b>	<b>277060-1**</b>	<b>277060-3**</b>

Wire ID Code	00	NX	NW	NT	NO	NN	MX
Copper Std. Round	1/0	2/0	2/0	2/0	2/0	2/0	3/0
Copper Compressed	1/0	2/0	2/0	2/0	2/0	2/0	3/0
Copper Compacted	2/0	3/0	3/0	3/0	3/0	3/0	4/0
Copper Solid	2/0	3/0	3/0	3/0	3/0	3/0	4/0
COPPERWELD	7 No. 8, 1G, 3 No. 5, 2K, 1/0F, 2A, 1J, 4P	7 No. 7, 1/0G, 2/0F, 1K, 1/0J, 2N	7 No. 7, 1/0G, 2/0F, 1K, 1/0J, 2N	7 No. 7, 1/0G, 2/0F, 1K, 1/0J, 2N	7 No. 7, 1/0G, 2/0F, 1K, 1/0J, 2N	7 No. 7, 1/0G, 2/0F, 1K, 1/0J, 2N	7 No. 6, 1N, 2/0J, 2P, 2/0G, 1/0KN
Ground Rod	3/8"	-	-	-	-	-	1/2"
Pin Diameter	3/8"	-	-	-	-	-	1/2"
Copper Std. Round	1/0	5, 6	4, 3	2, 1	1/0	2/0	5, 6
Copper Compressed	1/0	-	4	2, 1	1/0	2/0	-
Copper Compacted	2/0	4	2	1, 1/0	2/0	3/0	4
Copper Solid	2/0	4	3, 2	1, 1/0	2/0	3/0	4
COPPERWELD	7 No.8, 1G, 3 No. 5, 2K, 1/0F, 2A, 1J, 4P	8A	3 No. 10, 6C, 3 No.9, 6A, 3 No. 8, 8D, 6D	7 No. 10, 1F, 4N, 7 No. 9, 2J, 4D, 3 No. 7, 2G, 4A, 3 No. 6, 2F	7 No. 8, 1G, 3 No. 5, 2K, 1/0F, 2A, 1J, 4P	7 No. 7, 1/0G, 2/0F, 1K, 1/0J, 2N	8A
Ground Rod	3/8"	-	-	-	3/8"	-	-
Pin Diameter	3/8"	-	-	-	3/8"	-	-
<b>Use Tap Number</b>	<b>1-275187-8*</b>	<b>4-275187-0*</b>	<b>3-275187-9</b>	<b>1-275187-7*</b>	<b>1-275187-6*</b>	<b>1-275187-5*</b>	<b>3-275187-7*</b>

\*UL Listed

## Copper Taps

Wire ID Code	-	-	-
Copper Std. Round	2	2	2
Copper Compressed	-	-	-
Copper Compacted	-	-	-
Copper Solid	2, 1/0	1/0	-
COPPERWELD	-	-	-
Ground Rod	-	-	-
Pin Diameter	-	-	-
			
Copper Std. Round	8, 6	4	2
Copper Compressed	-	-	-
Copper Compacted	-	---	-
Copper Solid	-	4, 2	1/0
COPPERWELD	-	-	-
Ground Rod	-	-	-
Pin Diameter	-	-	-
<b>Use Tap Number</b>	<b>277060-3**</b>	<b>277060-2**</b>	<b>277060-1**</b>

Wire ID Code	MW	MT	MO	MN	MM	LX	LW
Copper Std. Round	3/0	3/0	3/0	3/0	3/0	4/0	4/0
Copper Compressed	3/0	3/0	3/0	3/0	3/0	4/0, 250.0	4/0, 250.0
Copper Compacted	4/0	4/0	4/0	4/0	4/0	250.0	250.0
Copper Solid	4/0	4/0	4/0	4/0	4/0	-	-
COPPERWELD	7 No. 6, 1N, 2/0J, 2P, 2/0G, 1/0KN	7 No. 6, 1N, 2/0J, 2P, 2/0G, 1/0KN	7 No. 6, 1N, 2/0J, 2P, 2/0G, 1/0K	7 No. 6, 1N, 2/0J, 2P, 2/0G, 1/0K	7 No. 6, 1N, 2/0J, 2P, 2/0G, 1/0K	7 No. 5, 4/0F, 2/0K	7 No. 5, 4/0F, 2/0K
Ground Rod	1/2"	1/2"	1/2"	1/2"	1/2"	-	-
Pin Diameter	1/2"	1/2"	1/2"	1/2"	1/2"	-	-
							
Copper Std. Round	4, 3	2, 1	1/0	2/0	3/0	5, 6	4, 3
Copper Compressed	4	2, 1	1/0	2/0	3/0	-	4
Copper Compacted	2	1, 1/0	2/0	3/0	4/0	4	2
Copper Solid	3, 2	1, 1/0	2/0	3/0	4/0	4	3, 2
COPPERWELD	3 No. 10, 6C, 3 No. 9, 6A, 3 No. 8, 8D, 6D	7 No. 10, 1F, 4N, 7 No.9, 2J, 4D, 3 No. 7, 2G, 4A, 3 No. 6, 2F	7 No. 8, 1G, 3 No. 5, 2K, 1/0F, 2A, 1J, 4P	7 No. 7, 1/0G, 2/0F, 1K, 1/0J, 2N	7 No. 6, 1N, 2/0J, 2P, 2/0G, 1/0K	8A	3 No. 10, 6C, 3 No. 9, 6A, 3 No. 8, 8D, 6D
Ground Rod	-	-	3/8"	-	1/2"	-	-
Pin Diameter	-	-	3/8"	-	1/2"	-	-
<b>Use Tap Number</b>	<b>3-275187-6*</b>	<b>1-275187-4*</b>	<b>1-275187-3*</b>	<b>1-275187-2*</b>	<b>1-275187-1*</b>	<b>3-275187-4*</b>	<b>3-275187-3*</b>

\*UL Listed

## Copper Taps

Wire ID Code	LT	LO	LN	LM	LL	RX	RW
Copper Std. Round	4/0	4/0	4/0	4/0	4/0	250.0	250.0
Copper Compressed	4/0, 250.0	4/0, 250/0	4/0, 250/0	4/0, 250/0	4/0, 250/0	300/0	300/0
Copper Compacted	250.0	250.0	250.0	250.0	250.0	300.0, 350.0	300.0, 350.0
Copper Solid	–	–	–	–	–	–	–
COPPERWELD	7 No. 5, 4/0F, 2/0K	7 No. 5, 4/0F, 2/0K	7 No. 5, 4/0F, 2/0K	7 No. 5, 4/0F, 2/0K	7 No. 5, 4/0F, 2/0K	19 No. 9, 4/0EK, 7 No. 4, 4/0E, 250EK, 4/0G	19 No. 9, 4/0EK, 7 No. 4, 4/0E, 250EK, 4/0G
Ground Rod	–	–	–	–	–	5/8"	5/8"
Pin Diameter	–	–	–	–	–	9/16"	9/16"
Copper Std. Round	2, 1	1/0	2/0	3/0	4/0	5, 6	4, 3
Copper Compressed	2, 1	1/0	2/0	3/0	4/0, 250.0	–	4
Copper Compacted	1, 1/0	2/0	3/0	4/0	250.0	4	2
Copper Solid	1, 1/0	2/0	3/0	4/0	–	4	3, 2
COPPERWELD	7 No. 10, 1F, 4N, 7 No.9, 2J, 4D, 3 No. 7, 2G, 4A, 3 No. 6, 2F	7 No. 8, 1G, 3 No. 5, 2K, 1/0F, 2A, 1J, 4P	7 No. 7, 1/0G, 2/0F, 1K, 1/0J, 2N	7 No. 6, 1N, 2/0J, 2P, 2/0G, 1/0K	7 No. 5, 4/0F, 2/0K	8A	3 No. 10, 6C, 3 No. 9, 6A, 3 No. 8, 8D, 6D
Ground Rod	–	3/8"	–	1/2"	–	–	–
Pin Diameter	–	3/8"	–	1/2"	–	–	–
<b>Use Tap Number</b>	<b>1-275187-0*</b>	<b>275187-9*</b>	<b>275187-8*</b>	<b>275187-7*</b>	<b>275187-6*</b>	<b>3-275187-1*</b>	<b>3-275187-0*</b>

Wire ID Code	HX	HW	HT	HO	HN	HM	HL
Copper Std. Round	300.0	300.0	300.0	300.0	300.0	300.0	300.0
Copper Compressed	–	–	–	–	–	–	–
Copper Compacted	–	–	–	–	–	–	–
Copper Solid	–	–	–	–	–	–	–
COPPERWELD	19 No. 8, 250EK	19 No. 8, 250EK	19 No. 8, 250EK	19 No. 8, 250EK	19 No. 8, 250EK	19 No. 8, 250EK	19 No. 8, 250EK
Ground Rod	–	–	–	–	–	–	–
Pin Diameter	5/8"	5/8"	5/8"	5/8"	5/8"	5/8"	5/8"
Copper Std. Round	5, 6	4, 3	2, 1	1/0	2/0	3/0	4/0
Copper Compressed	–	4	2, 1	1/0	2/0	3/0	4/0, 250.0
Copper Compacted	4	2	1, 1/0	2/0	3/0	4/0	250.0
Copper Solid	4	3, 2	1, 1/0	2/0	3/0	4/0	–
COPPERWELD	8A	3 No. 10, 6C, 3 No. 9, 6A, 3 No. 8, 8D, 6D	7 No. 10, 1F, 4N, 7 No.9, 2J, 4D, 3 No. 7, 2G, 4A, 3 No. 6 2F	7 No. 8, 1G, 3 No. 5, 2K, 1/0F, 2A, 1J, 4P	7 No. 7, 1/0G, 2/0F, 1K, 1/0J, 2N	7 No. 6, 1N,2/0J, 2P, 2/0G, 1/0K	7 No. 5, 4/0F, 2/0K
Ground Rod	–	–	–	3/8"	–	1/2"	–
Pin Diameter	–	–	–	3/8"	–	1/2"	–
<b>Use Tap Number</b>	<b>6-276337-5*</b>	<b>6-276337-4*</b>	<b>6-276337-2*</b>	<b>6-276337-0*</b>	<b>5-276337-9*</b>	<b>5-276337-8*</b>	<b>5-276337-7*</b>

\*UL Listed

## Copper Taps

Wire ID Code	RT	RO	RN	RM	RL	RR
Copper Std. Round	250.0	250.0	250.0	250.0	250.0	250.0
Copper Compressed	300.0	300.0	300.0	300.0	300.0	300.0
Copper Compacted	300.0, 350.0	300.0, 350.0	300.0, 350.0	300.0, 350.0	300.0, 350.0	300.0, 350.0
Copper Solid	–	–	–	–	–	–
COPPERWELD	19 No. 9, 4/0EK, 7 No. 4, 4/0E, 250EK, 4/0G	19 No. 9, 4/0EK, 7 No. 4, 4/0E, 250EK, 4/0G	19 No. 9, 4/0EK, 7 No. 4, 4/0E, 250EK, 4/0G	19 No. 9, 4/0EK, 7 No. 4, 4/0E, 250EK, 4/0G	19 No. 9, 4/0EK, 7 No. 4, 4/0E, 250EK, 4/0G	19 No. 9, 4/0EK, 7 No. 4, 4/0E, 250EK, 4/0G
Ground Rod	5/8"	5/8"	5/8"	5/8"	5/8"	5/8"
Pin Diameter	9/16"	9/16"	9/16"	9/16"	9/16"	9/16"



Copper Std. Round	2, 1	1/0	2/0	3/0	4/0	250.0
Copper Compressed	2, 1	1/0	2/0	3/0	4/0, 250.0	300.0
Copper Compacted	1, 1/0	2/0	3/0	4/0	250.0	300.0, 350.0
Copper Solid	1, 1/0	2/0	3/0	4/0	–	–
COPPERWELD	7 No. 10, 1F, 4N, 7 No. 9, 2J, 4D, 3 No. 7, 2G, 4A, 3 No. 6, 2F	7 No. 8, 1G, 3 No. 5, 2K, 1/0F, 2A, 1J, 4P	7 No. 7, 1/0G, 2/0F, 1K, 1/0J, 2N	7 No. 6, 1N, 2/0J, 2P, 2/0G, 1/0K	7 No. 5, 4/0F, 2/0K	19 No. 9, 4/0EK, 7 No. 4, 4/0E, 250EK, 4/0G
Ground Rod	–	3/8"	–	1/2"	–	5/8"
Pin Diameter	–	3/8"	–	1/2"	–	9/16"

<b>Use Tap Number</b>	<b>275187-5*</b>	<b>275187-4*</b>	<b>275187-3*</b>	<b>275187-2*</b>	<b>275187-1*</b>	<b>2-275187-8*</b>
-----------------------	------------------	------------------	------------------	------------------	------------------	--------------------

Wire ID Code	HK	HH	GX	GW	GT	GO	GN
Copper Std. Round	300.0	300.0	350.0	350.0	350.0	350.0	350.0
Copper Compressed	–	–	350.0	350.0	350.0	350.0	350.0
Copper Compacted	–	–	400.0	400.0	400.0	400.0	400.0
Copper Solid	–	–	–	–	–	–	–
COPPERWELD	19 No. 8, 250EK	19 No. 8, 250EK	300EK, 250EK	300EK, 250EK	300EK, 250EK	300EK, 250EK	300EK, 250EK
Ground Rod	–	–	3/4"	3/4"	3/4"	3/4"	3/4"
Pin Diameter	5/8"	5/8"	–	–	–	–	–



Copper Std. Round	250.0	300.0	5, 6	4, 3	2, 1	1/0	2/0
Copper Compressed	300.0	–	–	4	2, 1	1/0	2/0
Copper Compacted	300.0	–	4	2	1, 1/0	2/0	3/0
Copper Solid	300.0, 350.0	–	4	3, 2	1, 1/0	2/0	3/0
COPPERWELD	19 No. 9, 4/0EK, 7 No. 4, 4/0E, 250EK, 4/0G	19 No. 8, 250EK	8A	3 No. 10, 6C, 3 No. 9, 6A, 3 No. 8, 8D, 6D	7 No. 10, 1F, 4N, 7 No. 9, 2J, 4D, 3 No. 7, 2G, 4A, 3 No. 6, 2F	7 No. 8, 1G, 3 No. 5, 2K, 1/0F, 2A, 1J, 4P	7 No. 7, 1/0G, 2/0F, 1K, 1/0J, 2N
Ground Rod	5/8"	–	–	–	–	3/8"	–
Pin Diameter	–	5/8"	–	–	–	3/8"	–

<b>Use Tap Number</b>	<b>5-276337-6*</b>	<b>5-276337-5*</b>	<b>5-276337-4*</b>	<b>5-276337-3*</b>	<b>5-276337-1*</b>	<b>4-276337-9*</b>	<b>4-276337-8*</b>
-----------------------	--------------------	--------------------	--------------------	--------------------	--------------------	--------------------	--------------------

\*UL Listed







Copper Taps

Wire ID Code	GM	GL	GK	GH	GG	EX	EW
Copper Std. Round	350.0	350.0	350.0	350.0	350.0	400.0	400.0
Copper Compressed	350.0	350.0	350.0	350.0	350.0	400.0	400.0
Copper Compacted	400.0	400.0	400.0	400.0	400.0	450.0, 500.0	450.0, 500.0
Copper Solid	–	–	–	–	–	–	–
COPPERWELD	300EK, 250EK	300EK, 250EK	300EK, 250EK	300EK, 250EK	300EK, 250EK	300E, 350EK, 19 No. 7, 37 No. 10	300E, 350EK, 19 No. 7, 37 No. 10
Ground Rod	3/4"	3/4"	3/4"	3/4"	3/4"	–	–
Pin Diameter	–	–	–	–	–	–	–
Copper Std. Round	3/0	4/0	250.0	300	350.0	5, 6	4, 3
Copper Compressed	3/0	4/0, 250.0	300.0	–	350.0	–	4
Copper Compacted	4/0	250.0	300.0, 350.0	–	400.0	4	2
Copper Solid	4/0	–	–	–	–	4	3, 2
COPPERWELD	7 No. 6, 1N, 2/OJ, 2P, 2/OG, 1/OK	7 No. 5, 4/OF, 2/OK	19 No. 9, 4/0EK, 7 No. 4, 4/0E, 250EK, 4/OG	19 No. 8, 250EK	300EK, 250EK	#8A	3 No. 10, 6C, 3 No. 9, 6A, 3 No. 8, 8D, #6D
Ground Rod	1/2"	–	5/8"	–	3/4"	–	–
Pin Diameter	1/2"	–	9/16"	5/8"	–	–	–
<b>Use Tap Number</b>	<b>4-276337-7*</b>	<b>4-276337-6*</b>	<b>4-276337-5*</b>	<b>4-276337-4*</b>	<b>4-276337-3*</b>	<b>4-276337-2*</b>	<b>4-276337-1*</b>







Wire ID Code	EG	EE	BX	BW	BT	BO	BN
Copper Std. Round	400.0	400.0	450.0	450.0	450.0	450.0	450.0
Copper Compressed	400.0	400.0	450.0	450.0	450.0	450.0	450.0
Copper Compacted	450.0, 500.0	450.0, 500.0	550.0	550.0	550.0	550.0	550.0
Copper Solid	–	–	–	–	–	–	–
COPPERWELD	300E, 350EK, 19 No. 7, 37 No. 10	300E, 350EK, 19 No. 7, 37 No. 10	–	–	–	–	–
Ground Rod	–	–	–	–	–	–	–
Pin Diameter	–	–	3/4"	3/4"	3/4"	3/4"	3/4"
Copper Std. Round	350.0	400.0	5, 6	4, 3	2, 1	1/0	2/0
Copper Compressed	350.0	400.0	–	4	2, 1	1/0	2/0
Copper Compacted	400.0	450.0, 500.0	4	2	1, 1/0	2/0	3/0
Copper Solid	–	–	4	3, 2	1, 1/0	2/0	3/0
COPPERWELD	300EK, 250EK	300E, 350EK, 19 No. 7, 37 No. 10	#8A	3 No. 10, 6C, 3 No. 9, 6A, 3 No. 8, 8D, #6D	7 No. 10, 1F, 4N, 7 No.9, 2J, 4D, 3 No. 7, 2G, 4A, 3 No. 6, 2F	7 No. 8, 1G, 3 No. 5, 2K, 1/0F, 2A, 1J, 4P	7 No. 7, 1/0G, 2/0F, 1K, 1/0J, 2N
Ground Rod	3/4"	–	–	–	–	3/8"	–
Pin Diameter	–	–	–	–	–	3/8"	–
<b>Use Tap Number</b>	<b>3-276337-1*</b>	<b>3-276337-0*</b>	<b>2-276337-9*</b>	<b>2-276337-8*</b>	<b>276337-4*</b>	<b>2-276337-5*</b>	<b>276337-3*</b>

\*UL Listed

## Copper Taps

Wire ID Code	ET	EO	EN	EM	EL	EK	EH
Copper Std. Round	400.0	400.0	400.0	400.0	400.0	400.0	400.0
Copper Compressed	400.0	400.0	400.0	400.0	400.0	400.0	400.0
Copper Compacted	450.0, 500.0	450.0, 500.0	450.0, 500.0	450.0, 500.0	450.0, 500.0	450.0, 500.0	450.0, 500.0
Copper Solid	–	–	–	–	–	–	–
COPPERWELD	300E, 350EK, 19 No. 7, 37 No. 10	300E, 350EK, 19 No. 7, 37 No. 10	300E, 350EK, 19 No. 7, 37 No. 10	300E, 350EK, 19 No. 7, 37 No. 10	300E, 350EK, 19 No. 7, 37 No. 10	300E, 350EK, 19 No. 7, 37 No. 10	300E, 350EK, 19 No. 7, 37 No. 10
Ground Rod	–	–	–	–	–	–	–
Pin Diameter	–	–	–	–	–	–	–
							
Copper Std. Round	2, 1	1/0	2/0	3/0	4/0	250.0	300.0
Copper Compressed	2, 1	1/0	2/0	3/0	4/0, 250.0	300.0	–
Copper Compacted	1, 1/0	2/0	3/0	4/0	250.0	300.0, 350.0	–
Copper Solid	1, 1/0	2/0	3/0	4/0	–	–	–
COPPERWELD	7 No. 10, 1F, 4N, 7 No.9, 2J, 4D, 3 No. 7, 2G, 4A, 3 No. 6, 2F	7 No. 8, 1G, 3 No. 5, 2K, 1/0F, 2A, 1J, 4P	7 No. 7, 1/0G, 2/0F, 1K, 1/0J, 2N	7 No. 6, 1N, 2/0J, 2P, 2/0G, 1/0K	7 No. 5, 4/0F, 2/0K	19 No. 9, 4/0EK, 7 No. 4, 4/0E, 250EK, 4/0G	19 No. 8, 250EK
Ground Rod	–	3/8"	–	1/2"	–	5/8"	–
Pin Diameter	–	3/8"	–	1/2"	–	9/16"	5/8"

**Use Tap Number**    3-276337-9\*    3-276337-7\*    3-276337-6\*    3-276337-5\*    3-276337-4\*    3-276337-3\*    4-276337-2\*

Wire ID Code	BM	BL	BK	BH	BG	BE	BB
Copper Std. Round	450.0	450.0	450.0	450.0	450.0	450.0	450.0
Copper Compressed	450.0	450.0	450.0	450.0	450.0	450.0	450.0
Copper Compacted	550.0	550.0	550.0	550.0	550.0	550.0	550.0
Copper Solid	–	–	–	–	–	–	–
COPPERWELD	–	–	–	–	–	–	–
Ground Rod	–	–	–	–	–	–	–
Pin Diameter	3/4"	3/4"	3/4"	3/4"	3/4"	3/4"	3/4"
							
Copper Std. Round	3/0	4/0	250.0	300	350.0	400.0	450.0
Copper Compressed	3/0	4/0, 250.0	300.0	–	350.0	400.0	450.0
Copper Compacted	4/0	250.0	300.0, 350.0	–	400.0	450.0, 500.0	550.0
Copper Solid	4/0	–	–	–	–	–	–
COPPERWELD	7 No. 6, 1N, 2/0J, 2P, 2/0G, 1/0K	7 No. 5, 4/0F, 2/0K	19 No. 9, 4/0EK, 7 No. 4, 4/0E, 250EK, 4/0G	19 No. 8, 250EK	300EK, 250EK	300E, 350EK, 19 No. 7, 37 No. 10	–
Ground Rod	1/2"	–	5/8"	–	3/4"	–	–
Pin Diameter	1/2"	–	9/16"	5/8"	–	–	3/4"

**Use Tap Number**    2-276337-4\*    276337-2\*    2-276337-3\*    2-276337-2\*    2-276337-1\*    2-276337-0\*    1-276337-9\*

\*UL Listed











## Copper Taps

Wire ID Code	AX	AW	AT	AO	AN	AM	AL
Copper Std. Round	500.0	500.0	500.0	500.0	500.0	500.0	500.0
Copper Compressed	500.0	500.0	500.0	500.0	500.0	500.0	500.0
Copper Compacted	600.0	600.0	600.0	600.0	600.0	600.0	600.0
Copper Solid	–	–	–	–	–	–	–
COPPERWELD	350E, 19 No.6, 37 No. 9	350E, 19 No.6, 37 No. 9	350E, 19 No.6, 37 No. 9	350E, 19 No.6, 37 No. 9	350E, 19 No.6, 37 No. 9	350E, 19 No.6, 37 No. 9	350E, 19 No.6, 37 No. 9
Ground Rod	–	–	–	–	–	–	–
Pin Diameter	–	–	–	–	–	–	–
Copper Std. Round	5, 6	4, 3	2, 1	1/0	2/0	3/0	4/0
Copper Compressed	–	4	2, 1	1/0	2/0	3/0	4/0, 250.0
Copper Compacted	4	2	1, 1/0	2/0	3/0	4/0	250.0
Copper Solid	4	3, 2	1, 1/0	2/0	3/0	4/0	–
COPPERWELD	8A	3 No. 10, 6C, 3 No. 9, 6A, 3 No. 8, 8D, 6D	7 No. 10, 1F, 4N, 7 No. 9, 2J, 4D, 3 No. 7, 2G, 4A, 3 No. 6, 2F	7 No. 8, 1G, 3 No. 5, 2K, 1/0F, 2A, 1J, 4P	7 No. 7, 1/0G, 2/0F, 1K, 1/0J, 2N	7 No. 6, 1N, 2/0J, 2P, 2/0G, 1/0K	7 No. 5, 4/0F, 2/0K
Ground Rod	–	–	–	3/8"	–	1/2"	–
Pin Diameter	–	–	–	3/8"	–	1/2"	–
<b>Use Tap Number</b>	<b>1-276337-8*</b>	<b>1-276337-7*</b>	<b>276337-8*</b>	<b>1-276337-4*</b>	<b>276337-7*</b>	<b>1-276337-3*</b>	<b>276337-6*</b>

Wire ID Code	AK	AH	AG	AE	AB	AA
Copper Std. Round	500.0	500.0	500.0	500.0	500.0	500.0
Copper Compressed	500.0	500.0	500.0	500.0	500.0	500.0
Copper Compacted	600.0	600.0	600.0	600.0	600.0	600.0
Copper Solid	–	–	–	–	–	–
COPPERWELD	350E, 19 No.6, 37 No. 9	350E, 19 No.6, 37 No. 9	350E, 19 No.6, 37 No. 9	350E, 19 No.6, 37 No. 9	350E, 19 No.6, 37 No. 9	350E, 19 No.6, 37 No. 9
Ground Rod	–	–	–	–	–	–
Pin Diameter	–	–	–	–	–	–
Copper Std. Round	250.0	300.0	350.0	400.0	450.0	500.0
Copper Compressed	300.0	–	350.0	400.0	450.0	500.0
Copper Compacted	300.0, 350.0	–	400.0	450.0, 500.0	550.0	600.0
Copper Solid	–	–	–	–	–	–
COPPERWELD	19 No. 9, 4/0EK, 7 No. 4, 4/0E, 250EK, 4/0G	19 No. 8, 250EK	300EK, 250EK	300E, 350EK, 19 No. 7, 37 No. 10	–	350EK, 19 No. 6, 37 No. 9
Ground Rod	5/8"	–	3/4"	–	–	–
Pin Diameter	5/8"	5/8"	–	–	3/4"	–
<b>Use Tap Number</b>	<b>276337-9*</b>	<b>1-276337-2*</b>	<b>1-276337-1*</b>	<b>1-276337-0*</b>	<b>276337-1*</b>	<b>276337-5*</b>











\*UL Listed























Stirrup Selection Thru Wire Stranded	Red Shell No. 69338-2 Small Wire Range		White Shell No. 69338-5 Type II		
	ACSR Standard Round 	6 <sup>6/1</sup>	2, 3, 4, 5, 6 <sup>6/1</sup> , 7 <sup>7/1</sup>	6 <sup>6/1</sup>	2, 3, 4, 5, 6 <sup>6/1</sup> , 7 <sup>7/1</sup>
AAAC 6201 - 5003 	6	2, 3, 4, 5	6	2, 3, 4, 5	1/0, 1, 2, 3
AAC Standard Round 	6	2, 3, 4, 5	6	2, 3, 4, 5	1/0, 1, 2, 3
COPPER Standard Round 	6	2, 3, 4, 5	6	2, 3, 4, 5	2, 3
AAC Compressed or Compacted 	6	1, 2, 3, 4,	6	1, 2, 3, 4,	1/0, 1, 2
ACSR Compressed or Compacted 	6 <sup>6/1</sup>	2, 4, 6 <sup>6/1</sup> , 7 <sup>7/1</sup>	6 <sup>6/1</sup>	2, 4, 6 <sup>6/1</sup> , 7 <sup>7/1</sup>	1/0, 1, 2
AWAC, ACAR 	-	2 <sup>6/1</sup> , 3 <sup>4/3</sup> , 5 <sup>2</sup> , 6 <sup>1</sup> 4 <sup>3/4</sup> , 4 <sup>1/3</sup> , 5 <sup>2</sup> , 6 <sup>1</sup>	-	2 <sup>6/1</sup> , 3 <sup>4/3</sup> , 5 <sup>2</sup> , 6 <sup>1</sup> 4 <sup>3/4</sup> , 4 <sup>1/3</sup> , 5 <sup>2</sup> , 6 <sup>1</sup>	1/0 <sup>6/1</sup> , 2 <sup>6/1</sup> , 5 <sup>2</sup> , 4 <sup>3</sup> 3 <sup>4</sup> , 2 <sup>5</sup> , 1 <sup>6/1</sup> , 5 <sup>2</sup> , 4 <sup>3</sup> , 3 <sup>6/1</sup> , 5 <sup>2</sup> , 4 <sup>3</sup> , 3 <sup>4</sup> , 2 <sup>5</sup>
ALUMOWELD 	8A, 8C, 3 No. 12	2F, 2G, 3A, 4A, 4N, 5A, 5D, 6A, 6C, 6K, 7A, 7D, 8D, 3 No. 7, 3 No. 8, 3 No. 9, 3 No. 10, 7 No. 10, 7 No. 11, 7 No. 12	8A, 8C, 3 No. 12	2F, 2G, 3A, 4A, 4N, 5A, 5D, 6A, 6C, 6D, 7A, 7D, 8D, 3 No. 7, 3 No. 8, 3 No. 9, 3 No. 10, 7 No. 10, 7 No. 11, 7 No. 12	4 <sup>5/2</sup> , 4 <sup>1/3</sup> , 3 <sup>4</sup> , 5 <sup>2</sup> , 1/0F, 1F, 1G, 1J, 2A, 2F, 2G, 2J, 2K, 3A, 4A, 4D, 4N, 4P, 5D, 6D, 3 No. 5, 6, 7, 8, 7 No. 8, 9, 10, 11
COPPERWELD					
Galvanized Steel 	3/16"	1/4", 5/16", 7/32", 9/32"	3/16"	1/4", 5/16", 7/32", 9/32"	9/32, 5/16, 11/32, 3/8
Solid: AL or CU 	4, 5, 6	3, 2, 1	4, 5, 6	3, 2, 1	1
Stirrup Color & Number	Red 600580	Red 600581	White / Blue 602585	White 602586 / 1443312-1	White 81667-1
Ball Size	#2	#2	#2	#2	#2











Red coded taps are not sold in North America and should be substituted with white coded taps.

\*UL Listed









Stirrup Selection Thru Wire Stranded		Blue Shell No. 69338-1 Medium Wire Range					
ACSR Standard Round		1, 1/0, 2/0 <sup>6/1</sup> , 80.0 <sup>8/1</sup>	1, 1/0, 2/0 <sup>8/1</sup> , 80.0 <sup>8/1</sup>	2/0, 3/0 <sup>6/1</sup> , 101.8, 110.8, 134.6 <sup>12/1</sup>	3/0, 4/0 <sup>6/1</sup> , 101.8, 110.8, 134.6 <sup>12/1</sup>	3/0, 4/0 <sup>6/1</sup> , 101.8, 110.8, 134.6 <sup>12/1</sup>	3/0, 4/0 <sup>6/1</sup> , 101.8, 110.8, 134.6 <sup>12/7</sup>
AAAC 6201 - 5003		1, 1/0, 2/0	1, 1/0, 2/0	1, 1/0, 2/0	3/0, 4/0	3/0, 4/0	3/0, 4/0
AAC Standard Round		1, 1/0, 2/0	1, 1/0, 2/0	1, 1/0, 2/0	3/0, 4/0	3/0, 4/0	4/0
COPPER Standard Round		1, 1/0, 2/0	1, 1/0, 2/0	1, 1/0, 2/0	3/0, 4/0	3/0, 4/0	4/0
AAC Compressed or Compacted		1/0, 2/0	1/0, 2/0	1/0, 2/0	3/0, 4/0, 250.0, 266.8	3/0, 4/0, 250.0, 266.8	4/0, 250.0, 266.8
ACSR Compressed or Compacted		1, 1/0, 2/0 <sup>6/1</sup>	1, 1/0, 2/0 <sup>6/1</sup>	1, 1/0, 2/0 <sup>6/1</sup>	3/0, 4/0 <sup>6/1</sup> , 266.8 <sup>18/1</sup>	3/0, 4/0 <sup>6/1</sup> , 266.8 <sup>18/1</sup>	4/0 <sup>6/1</sup> , 266.8 <sup>18/1</sup>
AWAC, ACAR		2/0, 1/0, 1 <sup>6/1</sup> , 1/0 <sup>4/3</sup> , 2, 1/0, 5/2, 2, 1 <sup>2/5</sup> , 4/3, 3/4, 3 <sup>2/5</sup> , 3/4, 4 <sup>2/5</sup>	2/0, 1/0, 1 <sup>6/1</sup> , 1/0 <sup>4/3</sup> , 2, 1/0, 5/2, 2, 1 <sup>2/5</sup> , 4/3, 3/4, 3 <sup>2/5</sup> , 3/4, 4 <sup>2/5</sup>	2/0, 1/0, 1 <sup>6/1</sup> , 1/0 <sup>4/3</sup> , 2, 1/0, 5/2, 2, 1 <sup>2/5</sup> , 4/3, 3/4, 2 <sup>2/5</sup> , 3/4, 4 <sup>2/5</sup>	4/0 <sup>6/1</sup> , 3/0 <sup>4/3</sup> , 5/2, 6/1, 2/0 <sup>3/4</sup> , 4/3, 5/2, 1/0 <sup>2/5</sup> , 3/4, 1 <sup>2/5</sup>	4/0 <sup>6/1</sup> , 3/0 <sup>4/3</sup> , 5/2, 6/1, 2/0 <sup>3/4</sup> , 4/3, 5/2, 1/0 <sup>2/5</sup> , 3/4, 1 <sup>2/5</sup>	4/0 <sup>6/1</sup> , 3/0 <sup>4/3</sup> , 5/2, 6/1, 2/0 <sup>3/4</sup> , 4/3, 5/2, 1/0 <sup>2/5</sup> , 3/4, 1 <sup>2/5</sup>
ALUMOWELD		1/0F, 1F, 1G, 1/0J, 2/0F, 1F, 1G, 1J, 1K, 2A, 2J, 2K, 2N, 4D, 4P, 3 No. 5, 3 No. 6, 7 No. 7, 7 No. 8, 7 No. 9	1/0F, 1F, 1G, 1/0J, 2/0F, 1F, 1G, 1J, 1K, 2A, 2J, 2K, 2N, 4D, 4P, 3 No. 5, 3 No. 6, 7 No. 7, 7 No. 8, 7 No. 9	1/0F, 1/0F, 1/0G, 1/0J, 2/0F, 1F, 1G, 1J, 1K, 2A, 2J, 2K, 2N, 4D, 4P, 3 No. 5, 3 No. 6, 7 No. 7, 7 No. 9	1/0G, 1/0J, 1/0K, 2/0F, 2/0G, 2/0J, 1N, 2N, 2P, 7 No. 6, 7 No. 7	1/0K, 2/0G, 2/0J, 2/0K, 3/0F, 4/0F, 1N, 2P, 7 No. 5, 7 No. 6, 19 No. 10	1/0K, 2/0G, 2/0J, 2/0K, 3/0F, 4/0F, 1N, 2P, 7 No. 5, 7 No. 6, 19 No. 10
COPPERWELD							
Galvanized Steel		1 <sup>1/32</sup> ", 3/8", 7/16"	1 <sup>1/32</sup> ", 3/8", 7/16"	1 <sup>1/32</sup> ", 3/8", 7/16"	7/16", 1/12"	1/2", 9/16"	1/2", 9/16"
Solid: AL or CU		1/0, 2/0, 3/0	1/0, 2/0, 3/0	1/0, 2/0, 3/0	2/0, 3/0, 4/0	250.0, 266.8, 300.0, 3/0, 4/0	250.0, 266.8, 300.0, 4/0
Stirrup Color & Number		Blue 600464	Blue 275436-1	Blue 275436-1	Blue 600468	Blue 600469	Blue 275435-1
Ball Size		#2	#1/0	#1/0	#2	#2	#1/0

Stirrup Selection Thru Wire Stranded		Yellow Shell No. 69338-4 Large Wire Range					
ACSR Standard Round		336.4 <sup>26/7</sup> , 24/7, 18/1, 266.8 <sup>30/7</sup> , 300.0 <sup>18/1</sup> , 24/7, 26/7, 30/7, 211.3 <sup>12/7</sup> , 203.2 <sup>16/19</sup>	336.4 <sup>26/7</sup> , 24/7, 18/1, 266.8 <sup>30/7</sup> , 300.0 <sup>18/1</sup> , 24/7, 26/7, 30/7, 211.3 <sup>12/7</sup> , 203.2 <sup>16/19</sup>	336.4 <sup>26/7</sup> , 24/7, 18/1, 266.8 <sup>30/7</sup> , 300.0 <sup>18/1</sup> , 24/7, 26/7, 30/7, 211.3 <sup>12/7</sup> , 203.2 <sup>16/19</sup>	477.0 <sup>26/7</sup> , 24/7, 18/1, 336.4 <sup>30/7</sup> , 397.5 <sup>30/7</sup> , 26/7, 24/7, 18/1	477.0 <sup>26/7</sup> , 24/7, 18/1, 336.4 <sup>30/7</sup> , 397.5 <sup>30/7</sup> , 26/7, 24/7, 18/1	477.0 <sup>26/7</sup> , 24/7, 18/1, 336.4 <sup>30/7</sup> , 397.5 <sup>30/7</sup> , 26/7, 24/7, 18/1
AAAC 6201 - 5003		355.1, 394.5, 394.6	355.1, 394.5, 394.6	355.1, 394.5, 394.6	419.6, 466.3, 465.4, 503.6	419.6, 466.3, 465.4, 503.6	419.6, 466.3, 465.4, 503.6
AAC Standard Round		336.4, 350.0, 397.5, 400.0	336.4, 350.0, 397.5, 400.0	336.4, 350.0, 397.5, 400.0	450.0, 477.0, 500.0, 550.0, 556.5	450.0, 477.0, 500.0, 550.0, 556.5	450.0, 477.0, 500.0, 550.0, 556.5
COPPER Standard Round		350.0, 400.0	350.0, 400.0	350.0, 400.0	450.0, 500.0, 550.0	450.0, 500.0, 550.0	450.0, 500.0, 550.0
AAC Compressed or Compacted		336.4, 350.0, 397.5	336.4, 350.0, 397.5	336.4, 350.0, 397.5	477.0, 500.0, 556.6, 636.0	477.0, 500.0, 556.6, 636.0	477.0, 500.0, 556.6, 636.0
ACSR Compressed or Compacted		366.4, 397.5 <sup>18/1</sup>	366.4, 397.5 <sup>18/1</sup>	366.4, 397.5 <sup>18/1</sup>	477.0, 556.6, 636.0 <sup>18/1</sup>	477.0, 556.6, 636.0 <sup>18/1</sup>	477.0, 556.6, 636.0 <sup>18/1</sup>
AWAC, ACAR		343.6 <sup>15/4</sup> , 355.0 <sup>15/4</sup> , 12/7, 336.4 <sup>18/1</sup> , 16/3, 15/4	343.6 <sup>15/4</sup> , 355.0 <sup>15/4</sup> , 12/7, 336.4 <sup>18/1</sup> , 16/3, 15/4	343.6 <sup>15/4</sup> , 350.0 <sup>15/4</sup> , 15/4, 12/7, 336.4 <sup>18/1</sup> , 16/3, 15/4	503.6 <sup>15/4</sup> , 12/7, 336.4 <sup>15/4</sup>	503.6 <sup>15/4</sup> , 12/7, 336.4 <sup>15/4</sup>	503.6 <sup>15/4</sup> , 12/7, 336.4 <sup>15/4</sup>
ALUMOWELD		4/0E, 7 No. 4, 19 No. 7, 8, 37 No. 10	4/0E, 7 No. 4, 19 No. 7, 8, 37 No. 10	4/0E, 7 No. 4, 19 No. 7, 8, 37 No. 10	19 No. 6, 37 No. 8	19 No. 6, 37 No. 9	19 No. 6, 37 No. 9
COPPERWELD							
Galvanized Steel		5/8"	5/8"	5/8"	3/4"	3/4"	3/4"
Solid: AL or CU		450.0, 477.0, 500.0	450.0, 477.0, 500.0	450.0, 477.0, 500.0	-	-	-
Stirrup Color & Number		Yellow 600474	Yellow 602142	Yellow 602136	Yellow 602047	Yellow 602143	Yellow 602247
Ball Size		1/0	2/0	4/0	1/0	2/0	4/0

Stirrup Selection Thru Wire Stranded		Blue Shell No. 69338-1 Medium Wire Range				
ACSR Standard Round 	3/0, 4/0 <sup>6/1</sup> , 101.8, 110.8, 134.6 <sup>12/7</sup>	266.8 <sup>24/7, 26/7, 18/1, 6/7, 159.0, 176.9, 190<sup>12/7</sup></sup>	266.8 <sup>24/7, 26/7, 18/1, 6/7, 159.0, 176.9, 190<sup>12/7</sup></sup>	266.8 <sup>6/7, 18/1, 24/1, 26/7, 30/7, 300.0<sup>18/1, 24/7, 26/7, 336.4<sup>18/1</sup></sup></sup>	266.8 <sup>6/7, 18/1, 24/7, 26/7, 30/7, 300.0<sup>18/1, 24/7, 26/7, 336.4<sup>18/1</sup></sup></sup>	
AAAC 6201 - 5003 	3/0, 4/0	281.4, 307.1, 312.8	281.4, 307.1, 312.8	281.4, 307.1, 312.8, 355.1	281.4, 307.1, 312.8, 355.1	
AAC Standard Round 	4/0	250.0, 266.8, 300.0	250.0, 266.8, 300.0	300.0, 336.4, 350.0	300.0, 336.4, 350.0	
COPPER Standard Round 	4/0	250.0, 300.0	250.0, 300.0	250.0, 300.0, 350.0	250.0, 300.0, 350.0	
AAC Compressed or Compacted 	4/0, 250.0, 266.8	266.8, 300.0, 336.4, 350.0	266.8, 300.0, 336.4, 350.0	336.4, 350.0, 397.5	336.4, 350.0, 397.5	
ACSR Compressed or Compacted 	4/0 <sup>6/1</sup> 266.8 <sup>18/1</sup>	266.8, 336.4 <sup>18/1</sup>	266.8, 336.4 <sup>18/1</sup>	336.4, 397.5 <sup>18/1</sup>	336.4, 397.5 <sup>18/1</sup>	
AWAC, ACAR 	4/0 <sup>6/1, 3/0<sup>4/3, 5/2, 6/1, 2/0<sup>3/4, 4/3, 5/2, 1/0<sup>2/5, 3/4, 1<sup>2/5</sup></sup></sup></sup></sup>	4/0 <sup>15/4</sup>	4/0 <sup>15/4</sup>	336.4 <sup>18/1, 343.6<sup>15/4, 355.0<sup>15/4, 12/7</sup></sup></sup>	336.4 <sup>18/1, 343.6<sup>15/4, 355.0<sup>15/4, 12/7</sup></sup></sup>	
ALUMOWELD COPPERWELD 	1/0K, 2/0G, 2/0J, 2/0K, 3/0F, 4/0F, 1N, 2P, 7 No. 5, 7 No. 6, 19 No. 10	4/0E, 4/0G, 7 No. 4, 19 No. 8, 9	4/0E, 4/0G, 7 No. 4, 19 No. 8, 9	4/0E, 7 No. 4, 19 No. 8	4/0E, 7 No. 4, 19 No. 8	
Galvanized Steel 	1/2", 9/16"	5/8"	5/8"	5/8"	5/8"	
Solid: AL or CU 	250.0, 266.8, 300.0, 4/0	336.4, 350.0, 397.6, 400.0	336.4, 350.0, 397.6, 400.0	397.5, 400.0, 450.0	397.5, 400.0, 450.0	
Stirrup Color & Number	Blue 602173	Blue 600463	Blue 602201	Blue 602502	Blue 276478-2	
Ball Size	#2/0	#1/0	#1/0	#1/0	#2	

Stirrup Selection Thru Wire Stranded		Yellow Shell No. 69338-4 Large Wire Range				
ACSR Standard Round 	556.5 <sup>26/7, 24/7, 18/1, 477.0<sup>30/7, 26/7, 24/7</sup></sup>	556.5 <sup>26/7, 24/7, 18/1, 477.0<sup>30/7, 26/7, 24/7</sup></sup>	556.5 <sup>26/7, 24/7, 18/1, 477.0<sup>30/7, 26/7, 24/7</sup></sup>	556.5 <sup>30/7, 605.0, 636.0<sup>54/7, 24/7, 26/7, 30/19, 30/7, 18/1, 36/1, 653.9<sup>18/3, 666.6<sup>24/7, 54/7, 26/7</sup></sup></sup></sup>	556.5 <sup>30/7, 605.0, 636.0<sup>54/7, 24/7, 26/7, 30/19, 30/7, 18/1, 36/1, 653.9<sup>18/3, 666.6<sup>24/7, 54/7, 26/7</sup></sup></sup></sup>	
AAAC 6201 - 5003 	559.5, 587.2, 599.6, 652.4, 652.8	559.5, 587.2, 599.6, 652.4, 652.8	559.5, 587.2, 599.6, 652.4, 652.8	704.6, 740.8, 746.1	704.6, 740.8, 746.1	
AAC Standard Round 	550.0, 556.5, 600.0, 636.5	550.0, 556.5, 600.0, 636.5	550.0, 556.5, 600.0, 636.5	650.0, 700.0, 715.5, 750.0	650.0, 700.0, 715.5, 750.0	
COPPER Standard Round 	550.0, 600.0	550.0, 600.0	550.0, 600.0	650.0, 700.0, 750.0	650.0, 700.0, 750.0	
AAC Compressed or Compacted 	-	-	-	795.0, 874.5	795.0, 874.5	
ACSR Compressed or Compacted 	636.0 <sup>18/1</sup>	636.0 <sup>18/1</sup>	636.0 <sup>18/1</sup>	795.0, 874.5 <sup>36/1</sup>	795.0, 874.5 <sup>36/1</sup>	
AWAC, ACAR 	653.1 <sup>15/4, 12/7, 568.3<sup>15/4</sup></sup>	653.1 <sup>15/4, 12/7, 568.3<sup>15/4</sup></sup>	653.1 <sup>15/4, 12/7, 568.3<sup>15/4</sup></sup>	739.8 <sup>33/4, 30/7, 24/13, 18/19</sup>	739.8 <sup>33/4, 30/7, 24/13, 18/19</sup>	
ALUMOWELD COPPERWELD 	19 No. 5, 37 No. 8	19 No. 5, 37 No. 8	19 No. 5, 37 No. 8	37 No. 7	37 No. 7	
Galvanized Steel 	7/8"	7/8"	7/8"	1"	1"	
Solid: AL or CU 	-	-	-	-	-	
Stirrup Color & Number	Yellow 602104	Yellow 602248	Yellow 602115	Yellow 602174	Yellow 275074	
Ball Size	1/0	2/0	4/0	2/0	4/0	

## Stirrups

Stirrup Selection Thru Wire Stranded		Yellow Shell No. 69338-4 Large Wire Range		
ACSR Standard Round		715.5, 795.5 <sup>54/7</sup> , 24/7, 26/7, 30/19, 30/7, 45/7, 795.5 <sup>36/1</sup> , 874.5 <sup>45/7</sup>	715.5, 795.5 <sup>54/7</sup> , 24/7, 26/7, 30/19, 30/7, 45/7, 795.5 <sup>36/1</sup> , 874.5 <sup>45/7</sup>	874.5 <sup>54/7</sup> , 900.0 <sup>45/7</sup> , 54/7, 954.0 <sup>30/7</sup> , 1033.5 <sup>36/1</sup> , 45/7, 54/7
AAAC 6201 - 5003		833.6, 927.2, 932.6	833.6, 927.2, 932.6	—
AAC Standard Round		795.0, 800.0, 874.5, 900.0, 954.0	795.0, 800.0, 874.5, 900.0, 954.0	1000.0, 1033.5, 1100.0, 1113.0
COPPER Standard Round		800.0, 850.0, 900.0	800.0, 850.0, 900.0	1000.0
AAC Compressed or Compacted		954.0	954.0	—
ACSR Compressed or Compacted		954.0 <sup>36/1</sup>	954.0 <sup>36/1</sup>	—
AWAC, ACAR		819.2, 853.7, 927.2, 983.1 <sup>30/7</sup> , 840.2, 853.7, 927.2 <sup>24/13</sup> , 853.7, 862.7, 927.2 <sup>18/19</sup>	819.2, 853.7, 927.2, 983.1 <sup>30/7</sup> , 840.2, 853.7, 927.2 <sup>24/13</sup> , 853.7, 862.7, 927.2 <sup>18/19</sup>	1012.2 <sup>24/13</sup> , 1172.0 <sup>33/4</sup> , 1024.5, 1081.0, 1109.0, 1172.0 <sup>30/7</sup> , 24/13, 18/19
ALUMOWELD		37 No. 6	37 No. 6	—
COPPERWELD				
Galvanized Steel		—	—	—
Solid: AL or CU		—	—	—
Stirrup Color & Number		Yellow 602162	Yellow 602163	Yellow 602237
Ball Size		2/0	4/0	4/0



# IDENTIFICATION SOLUTIONS

## Heat-Shrink Markers

ShrinkMark Heat-Shrinkable Sleeves . . . . .92

## Cable Markers

CM-SCE Cable Markers . . . . .93  
 HLX-NEL Cable Markers . . . . .93  
 Permark Pre-Printed 316 Stainless Steel Markers. . . . .94  
 Snap-On Markers. . . . .94

## Labels

Self-Laminating Labels . . . . .95  
 Pressure Sensitive Polyester Labels . . . . .96  
 ProjectMark Continuous Labels . . . . .97  
 Clear UV Over Laminate . . . . .97

## Wire Markers

Insta-Mark Wire Marker Books and Dispensers . . . . .98

## Portable Marker Kit

LM2020 Plus Printer . . . . .99

## Accessories

Printers . . . . .100  
 Software . . . . .101  
 Ribbons . . . . .101  
 Miscellaneous Accessories . . . . .102



C\_ShrinkMark

## ShrinkMark Heat-Shrinkable Sleeves

Raychem ShrinkMark sleeves are suitable for a wide variety of applications. Heat-shrinkable sleeves provide legible identification for all types of cables used by electrical contractors and instrumentation control manufacturers.

Because ShrinkMark sleeves are extruded from Raychem tubing, they have a low installed profile with no edges to snag. The crosslinked polyolefin construction makes ShrinkMark sleeves resistant to abrasion, aggressive cleaning solvents, and industrial fluids.

ShrinkMark sleeves are ideal for tough industrial environments, including switch gear, motor control centers, and terminal boxes. They shrink faster than conventional thermoplastic tags.

- Shrink ratio of 3:1
- Expanded sleeve diameters from .125" (3.125 mm) to 1.50" (38 mm)
- Sleeves come in 2.00" (50 mm) lengths
- Flame retardant. Sleeves meet UL 224
- Print performance to military requirements
- ShrinkMark sleeves can be supplied pre-scored for a more economical use of material
- Several packaging options to choose from: 250, 1,000 or 2,500 pieces per box
- Standard colors are white and yellow
- Elliptical shape leaves un-shrunk sleeves in place
- Temperature range is -30°C to 105°C

### Selection Information: dimensions in inches (millimeters)

Catalog Number	Wire Size	Nominal Diameter	Recovered Diameter
ShrinkMark-18-2-9	#22-#18	0.125 (3)	0.042 (1)
ShrinkMark-18-2-S1-9	#22-#18	0.125 (3)	0.042 (1)
ShrinkMark-12-2-9	#18-#12	0.187 (5)	0.062 (2)
ShrinkMark-12-2-S1-9	#18-#12	0.187 (5)	0.062 (2)
ShrinkMark-10-2-9	#16-#10	0.250 (6)	0.083 (2)
ShrinkMark-10-2-S1-9	#16-#10	0.250 (6)	0.083 (2)
ShrinkMark-2-2-9	#10-#2	0.500 (13)	0.167 (4)
ShrinkMark-2-2-S1-9	#10-#2	0.500 (13)	0.167 (4)
ShrinkMark-250-2-9	#1-250	1.00 (25)	0.333 (9)
ShrinkMark-250-2-S1-9	#1-250	1.00 (25)	0.333 (9)
ShrinkMark-1000-2-9	350-1000	1.40 (36)	0.740 (19)
ShrinkMark-1000-2-S1-9	350-1000	1.40 (36)	0.740 (19)

\*Replace - 9 with - 4 if Yellow is needed

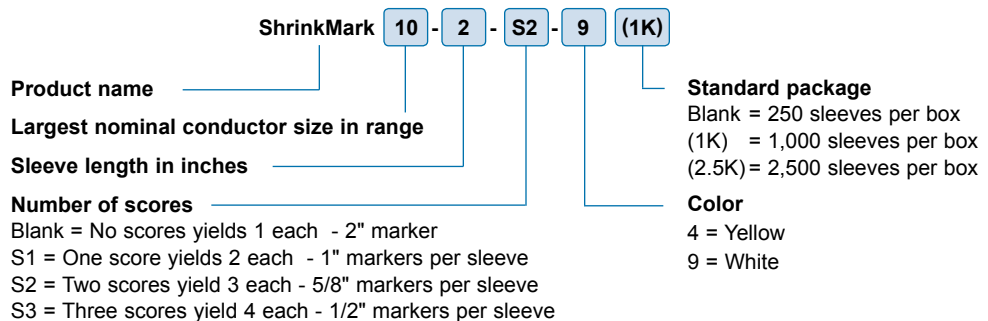

### Recommended

#### Printers

IDP-T208M-PRINTER  
 IDP-T312M-PRINTER  
 IDP-TE3112-PRINTER

#### Ribbons

IDP-T208M-RIBBON  
 IDP-TMS-RJS-RIBN-4RPSCE  
 IIDP-TMS-RJS-RIBN-4RPSCE



UL recognized to  
Standard 224



Certified  
C22.2  
No. 198.1



C\_CM\_SCE

## CM-SCE Cable Markers

Raychem CM-SCE cable markers provide a reliable method of identification of larger cables and bundles. They can be installed using standard nylon tie wraps.

- Markers are a standard 2" (55 mm) length that come in a .25" (6.25 mm) or .50" (12.7 mm) width
- Flame retardant
- Cable Markers meet UL 224
- Print performance to military requirements
- Standard color is white
- Temperature range is -55°C to 135°C

### Selection Information

Catalog Number	Description	Std. Pack
IDP-CM-SCE-25-4H-9	.25" Cable Marker, 4 hole	250
IDP-CM-SCE-50-4H-9	.5" Cable Marker, 4 hole	250
IDP-CM-SCE-50-6H-9	.5" Cable Marker, 6 hole	250

### Recommended

Printers	Ribbons
IDP-T312M-PRINTER	IDP-1966-RIBBON
IDP-TE3112-PRINTER	IDP-1966-RIBBON



C\_HLX\_Markers

## HLX-NEL Cable Markers

Raychem HLX markers are assembled in Narrow Edge Leading (NEL) format for use in the T208M printer. Markers are manufactured from low fire hazard polyolefin material making them ideal in applications where low smoke, low toxicity and zero halogen are critical.

- Ideal for pre- or post- termination assembly
- Attach using standard cable ties
- Temperature range is -40°C to 105°C

### Selection Information: dimensions in inches (millimeters)

Catalog Number	Marker Dimensions	Printable Area	Markers Across	Std. Pack
IDP-HLX125WE4NEL60S	3.15 x 0.49 (80 x 12.5)	2.35 x 0.4 (60 x 10.50)	4	200
IDP-HLX125WE2NEL60S	3.15 x 0.49 (80 x 12.5)	2.35 x 0.4 (60 x 10.50)	2	200
IDP-HLX125YW4NEL60S	3.15 x 0.49 (80 x 12.5)	2.35 x 0.4 (60 x 10.50)	4	200
IDP-HLX125YW2NEL60S	3.15 x 0.49 (80 x 12.5)	2.35 x 0.4 (60 x 10.50)	2	200

### Recommended

Printers	Ribbons
IDP-T208M-PRINTER	IDP-T200-RIBBON-1966
IDP-TE3112-PRINTER	IDP-1966-RIBBON



C\_Permark

## Permark Pre-Printed 316 Stainless Steel Markers

Permark stainless steel markers and identification plates are designed to withstand the most hostile environments. Using state-of-the-art technology and no inks, the marking process produces a permanent, deep surface mark. Permark markers are produced for individual customer requirements on a fast turn-around basis.

- Pre-marked to customer requirements
- Transfer of data files electronically
- Excellent chemical, abrasion, corrosion, and weather resistance
- One-piece, 316 stainless steel construction
- Stainless steel cable ties are also available
- Temperature range is -80°C to 500°C

### Selection Information: dimensions in inches (millimeters)

Catalog Number	Description	Std. Pack
IDP-PM09512	Stainless Steel 4 mm, 3.74 x 0.47 (95 x 12) marker - Pre-Printed (max 25 characters)	1
IDP-PM09512-BLANK	Stainless Steel 4 mm, 3.74 x 0.47 (95 x 12) marker - Blank	1
IDP-PM07507	Stainless Steel 4 mm, 2.95 x 0.28 (75 x 7) marker - Pre-Printed (max 20 characters)	1
IDP-PM07507-BLANK	Stainless Steel 4 mm, (75 x 70) marker - Blank	1
IDP-SST141-316	SS cable tie 0.18 x 14.3 (4.6 x 360), Ties/ Pack 100	100
IDP-SST71-316	SS cable tie 0.18 x 7.9 (4.6 x 200), Ties/ Pack 100	100

## Snap-On Markers



C\_SnapOn\_Markers

Snap-on markers represent the best snap-on wire marking system available. Convenient and easy to use, these markers are supplied on a "wand" applicator that simplifies and reduces installation time and saves on the cost of marking.

- Perfect way to permanently and rapidly mark cables and wires after installation
- Resistant against oils, cleaning agents, and fuels
- Markers come in white with black print. Color-coding options available for markers 0-9
- Temperature range is -40°C to 106°C

### Selection Information: dimensions in inches

Catalog Number	Wand Description	Color	Std. Pack
STD03W-x	Cable diameters 0.076-0.104 - 30 markers/wand, 10 wands/pack	Green	300
STD06W-x	Cable diameters 0.104-0.140 - 30 markers/wand, 10 wands/pack	Red	300
STD09W-x	Cable diameters 0.140-0.180 - 30 markers/wand, 10 wands/pack	Blue	300
STD12W-x	Cable diameters 0.180-0.240 - 30 markers/wand, 10 wands/pack	Yellow	300
STD15W-x	Cable diameters 0.232-0.340 - markers in loose packs, wand separate		50
STD17W-x	Cable diameters 0.340-0.460 - markers in loose packs, wand separate		50
STD21W-x	Cable diameters 0.433-0.610 - markers in loose packs, wand separate		50
STD24W-x	Cable diameters 0.590-0.750 - markers in loose packs, wand separate		50
STD15MO	Wand for marker size 15	Orange	1
STD17MO	Wand for marker size 17	Orange	1
STD21MO	Wand for marker size 21	Gray	1
STD24MO	Wand for marker size 24	Gray	1

\*Replace "x" in Catalog Number with the number or letter required on the markers.





C\_SelfLam\_Labels

## Self-Laminating Labels

Raychem Self-Laminating labels offer a fast and inexpensive way to identify wire and cable. Because these labels wrap over themselves, creating a seal, the printed surface is protected from solvents, oil, water, and abrasion. Self-Laminating labels can be printed using various thermal transfer printers.

- Self-Laminating labels offer a white area for printed or handwritten information and a clear wrap that winds around and protects the information
- Protects printed information from chemicals and frequent handling
- Designed to withstand exposure to oil, solvents, and water
- Vinyl material with acrylic adhesive
- UL recognized for indoor use
- Temperature Range: -40°C to 80°C

### Selection Information: dimensions in inches (millimeters)

Catalog Number	Maximum Cable OD	Print Area Height	Label		Labels/Roll
			Width	Height	
IDP-SB050100WE10	.20 (5.1)	.33 (8.5)	.50 (12.7)	1.00 (25.4)	10,000
IDP-SB050143WE10	.30 (7.6)	.50 (12.7)	.50 (12.7)	1.437 (36.5)	10,000
IDP-SB100143WE5	.30 (7.6)	.50 (12.7)	1.00 (25.4)	1.437 (36.5)	5,000
IDP-SB200143WE2.5	.30 (7.6)	.50 (12.7)	2.00 (50.8)	1.437 (36.5)	2,500
IDP-SB080150WE10	.30 (7.6)	.50 (12.7)	.80 (20.3)	1.50 (38.1)	10,000
IDP-SB100225WE5	.48 (12.2)	.75 (19)	1.00 (24.4)	2.25 (57.2)	5,000
IDP-SB200225WE2.5	.48 (12.2)	.75 (19)	2.00 (50.8)	2.25 (57.2)	2,500
IDP-SB100375WE2.5	.88 (22.4)	1.00 (25.4)	1.00 (25.4)	3.75 (95.3)	2,500
IDP-SB200375WE2.5	.88 (22.4)	1.00 (25.4)	2.00 (50.8)	3.75 (95.3)	2,500
IDP-SB100594WE1	1.40 (35.5)	1.50 (38.1)	1.00 (25.4)	5.94 (151)	1,000
IDP-SB190594WE1	1.40 (35.5)	1.50 (38.1)	1.90 (48.3)	5.94 (151)	1,000
IDP-SB200743WE1	1.90 (48.3)	1.50 (38.1)	2.00 (50.8)	7.437 (189)	1,000

*These standard labels fit inside the T312M Printer or they can feed into a T208M Printer using the IDP-T200-SPINDLE*

### T208M Size Rolls

IDP-SB050100WE5-T200	.20 (5.1)	.33 (8.5)	.50 (12.7)	1.00 (25.4)	5,000
IDP-SB050143WE5-T200	.30 (7.6)	.50 (12.7)	.50 (12.7)	1.437 (36.5)	5,000
IDP-SB100143WE2.5-T200	.30 (7.6)	.50 (12.7)	1.00 (25.4)	1.437 (36.5)	2,500
IDP-SB080150WE5-T200	.30 (7.6)	.50 (12.7)	.80 (20.3)	1.50 (38.1)	5,000
IDP-SB100225WE2.5-T200	.48 (12.2)	.75 (19)	1.00 (25.4)	2.25 (57.2)	2,500
IDP-SB200225WE1-T200	.48 (12.2)	.75 (19)	2.00 (50.8)	2.25 (57.2)	1,000
IDP-SB100375WE1-T200	.88 (22.4)	1.00 (25.4)	1.00 (25.4)	3.75 (95.3)	1,000
IDP-SB200375WE1-T200	.88 (22.4)	1.00 (25.4)	2.00 (50.8)	3.75 (95.3)	1,000
IDP-SB100594WE0.5-T200	1.40 (35.5)	1.50 (38.1)	1.00 (25.4)	5.94 (151)	500
IDP-SB200743WE0.5-T200	1.90 (48.3)	1.50 (38.1)	2.00 (50.8)	7.734 (189)	500

*These labels have a smaller core that allows them to fit inside of the T208M Printer. However, these are not recommended for the T312M Printer.*

### Recommended

*Printers*

IDP-T208M-PRINTER  
 IDP-T312M-PRINTER  
 IDP-TE3112-PRINTER

*Ribbons*

IDP-T208M-RIBBON  
 IDP-TMS-RJS-RIBN-4RPSCE  
 IDP-1330-0607-10



C\_Pressure\_Labels

## Pressure Sensitive Polyester Labels

TE's Raychem offers a wide range of label products for thermal transfer printing applications. Several material types and adhesives are available providing guaranteed results for your application. TE Connectivity is a UL recognized label supplier.

- Labels made of polyester provide the best material for your application
- Permanent acrylic adhesive provides excellent bond to many surfaces: tubing, wiring, cables or panels
- No heat curing process required
- Excellent for barcode applications
- Multiple die-cut sizes available
- MP = Metalized Polyester
- WP = White Polyester
- Temperature range is -40°C to 150°C

### Selection Information: dimensions in inches (millimeters)

Catalog Number	Label		Material	T208M	Labels per Roll
	Width	Height			
IDP-MP-191064-10-8A	.75 (19)	.25 (6.4)	Metalized Polyester	No	10,000
IDP-MP-203127-10-8A	.80 (20.3)	.50 (12.7)	Metalized Polyester	No	10,000
IDP-MP-254127-10-8A	1.00 (25.4)	.50 (12.7)	Metalized Polyester	Yes	10,000
IDP-MP-254254-10-8A	1.00 (25.4)	1.00 (25.4)	Metalized Polyester	Yes	10,000
IDP-MP-381064-10-8A	1.50 (38.1)	.25 (6.4)	Metalized Polyester	Yes	10,000
IDP-MP-381191-5-8A	1.50 (38.1)	.75 (19)	Metalized Polyester	No	5,000
IDP-MP-508254-5-8A	2.00 (50.8)	1.00 (25.4)	Metalized Polyester	Yes	5,000
IDP-MP-508318-2.5-8A	2.00 (50.8)	1.25 (31.8)	Metalized Polyester	Yes	2,500
IDP-MP-699254-5-8A	2.75 (70)	1.00 (25.4)	Metalized Polyester	Yes	5,000
IDP-MP-762381-2.5-8A	3.00 (76.2)	1.50 (38.1)	Metalized Polyester	Yes	2,500
IDP-MP-762508-2.5-8A	3.00 (76.2)	2.00 (50.8)	Metalized Polyester	Yes	2,500
IDP-MP-101635-2.5-8A	4.00 (101.6)	2.50 (63.5)	Metalized Polyester	Yes	2,500
IDP-WP-040040-25-9	.157 (4)	.157 (4)	White Polyester	No	25,000
IDP-WP-064064-25-9	.25 (6.4)	.25 (6.4)	White Polyester	No	25,000
IDP-WP-080080-10-9	.315 (8)	.315 (8)	White Polyester	No	10,000
IDP-WP-950950-10-9	.375 (9.5)	.375 (9.5)	White Polyester	Yes	10,000
IDP-WP-114040-25-9	.45 (11.4)	.157 (4)	White Polyester	No	25,000
IDP-WP-127111-10-9	.50 (12.7)	.437 (11.1)	White Polyester	Yes	10,000
IDP-WP-165102-10-9	.65 (16.5)	.40 (10.2)	White Polyester	Yes	10,000
IDP-WP-165051-25-9	.65 (16.5)	.20 (5.1)	White Polyester	No	25,000
IDP-WP-178095-10-9	.70 (17.8)	.375 (9.5)	White Polyester	No	10,000
IDP-WP-191064-10-9	.75 (19)	.25 (6.4)	White Polyester	No	10,000
IDP-WP-203127-10-9	.80 (20.3)	.50 (12.7)	White Polyester	No	10,000
IDP-WP-229064-10-9	.90 (22.9)	.25 (6.4)	White Polyester	Yes	10,000
IDP-WP-254097-10-9	1.00 (25.4)	.38 (9.7)	White Polyester	Yes	10,000
IDP-WP-254127-10-9	1.00 (25.4)	.50 (12.7)	White Polyester	Yes	10,000
IDP-WP-254254-10-9	1.00 (25.4)	1.00 (25.4)	White Polyester	Yes	10,000
IDP-WP-318064-10-9	1.25 (31.8)	.25 (6.4)	White Polyester	Yes	10,000
IDP-WP-381020-10-9	1.50 (38.1)	.08 (2)	White Polyester	Yes	10,000
IDP-WP-381064-10-9	1.50 (38.1)	.25 (6.4)	White Polyester	Yes	10,000
IDP-WP-381191-5-9	1.50 (38.1)	.75 (19)	White Polyester	No	5,000
IDP-WP-508127-5-9	2.00 (50.8)	.5 (12.7)	White Polyester	Yes	10,000
IDP-WP-508254-5-9	2.00 (50.8)	1.00 (25.4)	White Polyester	Yes	5,000
IDP-WP-508318-2.5-9	2.00 (50.8)	1.25 (31.8)	White Polyester	Yes	2,500
IDP-WP-508064-10-9	2.00 (50.8)	.25 (6.4)	White Polyester	Yes	10,000
IDP-WP-523841-1.5-9	2.06 (52.3)	3.31 (84.1)	White Polyester	Yes	1,500
IDP-WP-700254-5-9	2.75 (70)	1.00 (25.4)	White Polyester	Yes	5,000
IDP-WP-762381-2.5-9	3.00 (76.2)	1.50 (38.1)	White Polyester	Yes	2,500
IDP-WP-762508-2.5-9	3.00 (76.2)	2.0 (50.8)	White Polyester	Yes	2,500
IDP-WP-101635-2.5-9	4.00 (101.6)	2.50 (63.5)	White Polyester	Yes	2,500
IDP-WP-101165-0.85-9	4.00 (101.6)	6.50 (165)	White Polyester	Yes	900

\* All labels are compatible with T312M-Printer, but only those marked "Yes" in the T208M column are compatible with T208M Printer.

### Recommended

#### Printers

IDP-T208M-PRINTER  
IDP-T312M-PRINTER  
IDP-TE3112-PRINTER

#### Ribbons

IDP-1330-0607-T200  
IDP-1330-0607-10  
IDP-1330-0607-10



C\_ProjectMark

## ProjectMark Continuous Labels

The Raychem ProjectMark (TTPA) is a durable, high strength polyester material that can be used as warning and service labels, rating plates, and a way to identify cable trays—all of which can be produced on demand.

- High tack acrylic adhesive
- Resistant to moisture/humidity
- 4 printable continuous widths in several colors
- Material comes on a 100' reel and ranges from 1.0" (25 mm) to 4.0" (100 mm) wide
- Standard white ProjectMark labels have a 5 - 7 year outdoor life
- Apply a UV protection laminate (IDP-NPVF) to provide 15 year protection
- Temperature range is -40°C to 150°C

Standard Colors are White (WE) and Metalized Polyester (MP). Additional colors include the following: OE = Orange, GN = Green, BE = Blue, RD = Red, BK = Black, YW = Yellow, CL = Clear. High Performance Ribbon is recommended for colors other than White and/or Clear.

### Selection Information: dimensions in inches/feet

Catalog Number	Description	Color	Std. Pack
IDP-TTPA100WE-10*	Continuous Polyester 100 Ft Roll - 1" Wide	White (WE)	1
IDP-TTPA100YW-10*	Continuous Polyester 100 Ft Roll - 1" Wide	Yellow (YW)	1
IDP-TTPA200MP-10	Continuous Polyester 100 Ft Roll - 2" Wide	Metalized Poly (MP)	1
IDP-TTPA200WE-10	Continuous Polyester 100 Ft Roll - 2" Wide	White (WE)	1
IDP-TTPA300MP-10	Continuous Polyester 100 Ft Roll - 3" Wide	Metalized Poly (MP)	1
IDP-TTPA300WE-10	Continuous Polyester 100 Ft Roll - 3" Wide	White (WE)	1
IDP-TTPA400MP-10	Continuous Polyester 100 Ft Roll - 4" Wide	Metalized Poly (MP)	1
IDP-TTPA400WE-10	Continuous Polyester 100 Ft Roll - 4" Wide	White (WE)	1

\*1 inch wide rolls are only available in White and Yellow.

### Recommended

Printers	Ribbons
IDP-T312M-PRINTER	IDP-1330-0607-10 Standard Ribbon IDP-1330-0619-10 High Performance Ribbon
IDP-T208M-PRINTER*	IDP-1330-0607-T200 Standard Ribbon IDP-1330-0619-T200 High Performance Ribbon
IDP-TE3112-PRINTER	IDP-1330-0607-10

\*Software adjustments required to use the T208M with ProjectMark. Call 866-374-9655 for support.



C\_IDP\_Clear\_Laminate

## Clear UV Over Laminate

The Raychem NPVF-CL series is a range of clear non-printable polyvinyl fluoride tapes designed for use as an over laminate on wires/bundle identifiers where additional UV protection is required. These tapes can be used over various types of identifiers like wraparound labels, heat-shrink labels, tie-on cable labels and pressure-sensitive labels. This material can also be applied on top of ProjectMark labels when used in an outdoor environment.

- Resists water, oil, conventional cleaning agents, and oil based solvents
- Filters UV light
- Exhibits high degree of resistance to aging
- Meets the requirements of MIL-M-87958
- Temperature range -40°C to 130°C

### Selection Information: dimensions in inches/feet

Catalog Number	Description	Color	Std. Pack
IDP-NPVF200CL-100	2" x 100 Ft roll	Clear Over Laminate	1
IDP-NPVF300CL-100	3" x 100 Ft roll	Clear Over Laminate	1
IDP-NPVF400CL-100	4" x 100 Ft roll	Clear Over Laminate	1

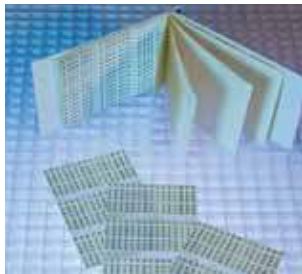

C\_InstaMark

## Insta-Mark Wire Marker Books & Dispensers

Raychem Insta-Mark Wire Marker Books and Dispensers offer a portable and convenient pocket-sized solution of vinyl impregnated cloth tape wire markers and self-laminating labels. Each item is packaged for Point-of-Purchase merchandising and provides an array of letters, numbers, symbols, or colors to easily identify any type of wire and/or terminal block.

Pre-Printed Marker Books (PPMB) contain 10 pages of pre-cut markers 1.25" long, totaling 450 wire markers with 450 matching terminal markers sized .1875" x .1875".

Write-On Self-Laminating Marker Books contain 10 pages of pre-cut self laminating markers made of .004" thick clear vinyl film, using an acrylic adhesive and mounted on a silicone release liner. The service temperature is -40°F to +200°F.

Pre-Printed Marker Dispensers (PPMD) are portable wire marker systems. Each dispenser contains 10 rolls of marker tape. Each roll contains 76 individual markers with a pre-determined length of 1.25" and a width of .25". Legends available are 0-9, A-J or the NEMA colors.

Write-On Marker Dispensers (WOMD) are a portable and disposable dispenser containing a roll of pre-cut Self-Laminating Wire Markers. Each marker has a white area available for legend inscription using a pen or pencil. The adhesive is an aggressive acrylic that is impervious to oil and water with a service temperature range of -40°F to +250°F.

### Selection Information: dimensions in inches

Catalog Number	Description	Std. Pack
CPCI-PPMB-01	Insta-Mark Pre-Printed Marker Book - 0-9	10
CPCI-PPMB-02	Insta-Mark Pre-Printed Marker Book - A-Z, 1-15, +, -, /	10
CPCI-PPMB-03	Insta-Mark Pre-Printed Marker Book - 1-45	10
CPCI-PPMB-04	Insta-Mark Pre-Printed Marker Book - 1, 2, 3	10
CPCI-PPMB-05	Insta-Mark Pre-Printed Marker Book - A, B, C	10
CPCI-PPMB-06	Insta-Mark Pre-Printed Marker Book - T1, T2, T3	10
CPCI-PPMB-07	Insta-Mark Pre-Printed Marker Book - L1, L2, L3	10
CPCI-PPMB-08	Insta-Mark Pre-Printed Marker Book - 46-90	10
CPCI-PPMB-09	Insta-Mark Pre-Printed Marker Book - 10 NEMA COLORS	10
CPCI-PPMB-10	Insta-Mark Pre-Printed Marker Book - AC, DC, POS, NEG, GND,	10
CPCI-PPMB-11	Insta-Mark Pre-Printed Marker Book - Burglar Alarm	10
CPCI-PPMB-12	Insta-Mark Pre-Printed Marker Book - 0-9, L1-L3, T1-T3	10
CPCI-PPMB-13	Insta-Mark Pre-Printed Marker Book - 1-30	10
CPCI-PPMB-14	Insta-Mark Pre-Printed Marker Book - 1-45, +/-, L1-L3, T1-T3,	10
CPCI-PPMB-15	Insta-Mark Pre-Printed Marker Book - 1, 2, 3, A, B, C, L1-L3, T1-T3	10
CPCI-PPMB-16	Insta-Mark Pre-Printed Marker Book - 1-45, 46-90, A-Z, +, -, /, 0	10
CPCI-PPMB-20	Insta-Mark Pre-Printed Marker Book - Circuit Breaker (3 SET)	10
CPCI-PPMB-21	Insta-Mark Pre-Printed Marker Book - Circuit Breaker (1 SET)	10
CPCI-PPMB-22	Insta-Mark Pre-Printed Marker Book - Fire Alarm	10
CPCI-WOMB-B30	Insta-Mark Write-on Marker Book - Label Size 1.0 x 5.0	10
CPCI-WOMB-B50	Insta-Mark Write-on Marker Book - Label Size 0.5 x 1.25	10
CPCI-WOMB-B60	Insta-Mark Write-on Marker Book - Label Size 1.0 x 2.5	10
CPCI-WOMB-B75	Insta-Mark Write-on Marker Book - Label Size .75 x 1.67	10
CPCI-PPMD-0-9	Insta-Mark Preprinted Marker Dispenser 0, 1, 2, 3, 4, 5, 6, 7, 8, 9	5
CPCI-PPMD-A-J	Insta-Mark Preprinted Marker Dispenser A, B, C, D, E, F, G, H, I, J	5
CPCI-PPMD-NEMA	Preprinted Marker Dispenser NEMA COLORS (Wht, Yel, Org, Red, Blu, Grn, Vio, Brn, Gry, Blk)	5
CPCI-PPMDRF-0-9	Preprinted Marker Dispenser REFILL 0, 1, 2, 3, 4, 5, 6, 7, 8, 9	5
CPCI-PPMDRF-A-J	Preprinted Marker Dispenser REFILL A, B, C, D, E, F, G, H, I, J	5
CPCI-PPMDRF-NEMA	Preprinted Marker Dispenser REFILL NEMA COLORS (Wht, Yel, Org, Red, Blu, Grn, Vio, Brn, Gry, Blk)	5
CPCI-WOMD-13	Insta-Mark Write-on Marker Dispensers - Label Size .75" x 3.0"	5
CPCI-WOMD-16	Insta-Mark Write-on Marker Dispensers - Label Size .75" x 6.0"	5
CPCI-WOMD-51	Insta-Mark Write-on Marker Dispensers - Label Size .75" x 1.25"	5
CPCI-WOMD-52	Insta-Mark Write-on Marker Dispensers - Label Size .75" x 1.75"	5



C\_LM2020

## LM2020 PLUS Portable Hand-Held Marking Kit

The Raychem LM2020 Plus system is an advanced portable thermal label printer. It is designed for both labeling and bar coding. The LM2020 Plus system is quick and easy to use in the field, office, or shop. The LM2020 Plus marker material and ribbon are pre-loaded into a snap-in cartridge. This allows for repeatable, error free loading into the printer.

### Features

- Minimum media width of 0.125" (3.2 mm). Maximum media width of 1.0" (25 mm)
- 67 point size ranging from 6 point to 72 point
- 10 resident bar codes
- Alphanumeric sequencing
- Battery-operated or AC power supply-operated
- Product and ribbon comes housed in easy-to-install cartridges

### Materials available

- Shrink tube wire and cable markers (White & Yellow)
- Self-laminating wrap-around wire and cable markers
- Industrial labels for tray and pipe identification

### Advantages over other portable systems

- No smearing—Ink dries immediately
- One-step loading process—No separate ribbon and markers to load
- 300 dpi thermal print quality—Superior print quality compared to 9-pin dot matrix printers
- Savings—Very affordable portable thermal printing system

### Selection Information: dimensions in inches/feet

Catalog Number	Description	Std. Pack
LM2020PLUS-PRINTER-KIT	Handheld printer, protective jacket, 6 ni-cad batteries	1
LM2020PLUS-2500MAH-NICAD	LM 2020 Rechargeable Batteries	1
LM-CASE	LM 2020 Hard Sided Carrying Case	1
LM-1/8-TUBE-WE	Shrinktube .125" x 100" Cartridge, White #16-#22	1
LM-1/8-TUBE-YW	Shrinktube .125" x 100" Cartridge, Yellow #16-#22	1
LM-3/16-TUBE-WE	Shrinktube .1875" x 100" Cartridge, White #12-#18	1
LM-3/16-TUBE-YW	Shrinktube .1875" x 100" Cartridge, Yellow #12-#18	1
LM-1/4-TUBE-WE	Shrinktube .25" x 100" Cartridge, White #10-#16	1
LM-1/4-TUBE-YW	Shrinktube .25" x 100" Cartridge, Yellow #10-#16	1
LM-1/2-TUBE-WE	Shrinktube .5" x 100" Cartridge, White #1-#12	1
LM-1/2-TUBE-YW	Shrinktube .5" x 100" Cartridge, Yellow #1-#12	1
LM-1/2-TAPE-BK	.5" x 40' Industrial Tape-White on Black	1
LM-1/2-TAPE-CR	.5" x 40' Industrial Tape-Black on Clear	1
LM-1/2-TAPE-WE	.5" x 40' Industrial Tape-Black on White	1
LM-1/2-TAPE-YW	.5" x 40' Industrial Tape-Black on Yellow	1
LM-1-TAPE-BK	1" x 40' Industrial Tape-White on Black	1
LM-1-TAPE-CR	1" x 40' Industrial Tape-Black on Clear	1
LM-1-TAPE-WE	1" x 40' Industrial Tape-Black on White	1
LM-1-TAPE-YW	1" x 40' Industrial Tape-Black on Yellow	1
LM-1/2-VINYL-CR	.5" x 40' Vinyl Industrial Tape-Black on Clear	1
LM-1/2-VINYL-RD	.5" x 40' Vinyl Industrial Tape-Black on Red	1
LM-1/2-VINYL-WE	.5" x 40' Vinyl Industrial Tape-Black on White	1
LM-1/2-VINYL-YW	.5" x 40' Vinyl Industrial Tape-Black on Yellow	1
LM-1-VINYL-CR	1" x 40' Vinyl Industrial Tape- Black on Clear	1
LM-1-VINYL-RD	1" x 40' Vinyl Industrial Tape-Black on Red	1
LM-1-VINYL-SR	1" x 40' Vinyl Industrial Tape-Black on Silver	1
LM-1-VINYL-WE	1" x 40' Vinyl Industrial Tape-Black on White	1
LM-1-VINYL-YW	1" x 40' Vinyl Industrial Tape-Black on Yellow	1
LM-1/2-SL	Self-Lam 1" x .50", Print Area 1" x .25", 230 each. Fits #16-#22	1
LM-3/4-SL	Self-Lam 1" x .75", Print Area 1" x .375", 250 each. Fits #10-#16	1
LM-1-SL	Self-Lam 1" x 1", Print Area 1" x .375", 200 each. Fits #10-#12	1
LM-1-1/4-SL	Self-Lam 1" x 1.25", Print Area 1" x .50", 170 each. Fits #8-#12	1
LM-2-1/2-SL	Self-Lam 1" x 2.50", Print Area 1" x .75", 108 each. Fits #6-#10	1
LM-4-SL	Self-Lam 1" x 4", Print Area 1" x 1", 81 each. Fits #4-#6	1

## Printers, Software & Accessories

These printers have been selected to suit a range of identification requirements and offer excellent legibility and mark permanence. An extensive range of ribbons has been designed for use with the TE Connectivity's identification products. These ribbons ensure excellent mark permanence and legibility to applicable industry specifications.



C\_Thermal\_Printer

### Thermal Transfer Printers

#### T208M Printer

T208M Printer Kit (Contains T208M-Printer & T208M-Ribbon) medium volume, 200 dpi printer. Lightweight printer with a 4.1" printhead that can print sleeves and labels. Parallel and USB ports provided. T208M-C-Printer comes with cutter for continuous labels, such as ProjectMark.

#### T312M Printer

T312M Printer is a high performance, yet cost effective thermal transfer printer with a 4.1" printhead. Robust, industrial computer-driven thermal transfer printer. This 300 dpi printer has been specially designed to print the full range of TE Connectivity cable identification and labeling products for the optimum in flexibility, print quality and permanence. With dual 32 bit processors this printer is ideal for high volume users. T312S-C-Printer comes with optional cutter, ideal for ProjectMark continuous labels, not recommended for ShrinkMark sleeves.



C\_TE3112\_Printer

### TE3112 Printer Thermal Transfer Printer

The TE3112-PRINTER is a high performance mid-range Identification printer for marking heat-shrinkable marker sleeves, cable marker tags and labels. With a 300 dpi print head, it's capable of marking a broad range of products for use in commercial and industrial environments.

- For printing on heat-shrinkable marker sleeves, cable marker tags and labels
- Approved to print the entire range of TE thermal transfer identification products
- For printing high quality texts, graphic images and barcodes
- For use with TE approved WinTotal ver. 4.9 and PEP-5 ver. 3 software packages.

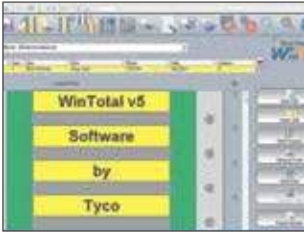

C\_WT\_Software

## WinTotal Software

WinTotal software is a powerful Windows software based package that makes identification marking quick and easy. The Windows environment gives access to a huge array of font options, including non-English fonts and also allows simple importing and manipulation of graphics and logos.

- Pre-loaded with all of TE Connectivity identification products
- Powerful import and export functions: reads wire lists from spreadsheets and text files
- Incremental alpha and numeric fields
- Automatic or manual routing to multiple printers
- Network compatible

WinTotal software option: Registered one time only and can only be used on the computer it is installed on. Please use the WinTotal USB Dongle option when software is to be shared among different computers.

### Selection Information

Catalog Number	Description	Std. Pack
IDP-T208M-PRINTER	Medium Vol. Thermal Trans Printer Kit, 4" Print head	1
IDP-T208M-C-PRINTER	Medium Vol. Thermal Trans Printer Kit, 4" Print head, with cutter	1
IDP-T312M-PRINTER	High Vol. Thermal Trans Printer Kit, 4" Print head, 3MB RAM	1
IDP-T312S-C-PRINTER	High Vol. Thermal Trans Printer Kit, 4" Print head, 3MB RAM, with cutter	1
IDP-TE3112-PRINTER	High performance mid range thermal trans printer kit, 300 dpi print head. Compatible with Wintotal software 4.9 and above	1
IDP-WINTOTAL-SWARE	WinTotal Software	1
IDP-WINTOTAL-SWARE-DGLUS	WinTotal Software with USB Dongle	1

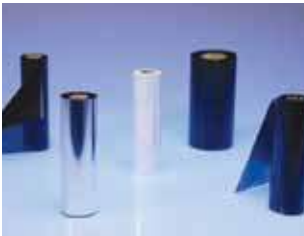

C\_Ribbon

## Ribbons

Printer	Ribbon	Print Media
IDP-T208M-PRINTER	IDP-T208M-RIBBON	ShrinkMark sleeves & SB labels
	IDP-1330-0607-T200	TTPA & MP, WP, WV labels
	IDP-1330-0619-T200	High performance
IDP-T312M-PRINTER	IDP-T200-RIBBON-1966	HLX-NEL cable markers
	IDP-TMS-RJS-RIBN-4RPSCE	ShrinkMark sleeves, SB labels, HL cable markers
	IDP-1330-0607-10	TTPA & MP, WP, WV labels
	IDP-1330-0619-10	High performance

### Selection Information: dimensions in inches/feet (millimeters/meters)

Catalog Number	Description	Std. Pack
IDP-T208M-RIBBON	Ribbon for T208M printer, use with heat-shrink sleeves & SB labels, 242 (74)	1
IDP-1330-0607-T200	Ribbon for T208 printer, use with TTPA, MP, WP, WV labels, 242 (74)	1
IDP-T200-RIBBON-1966	Ribbon for T208 printer, use with HLX-NEL cable markers, 242 (74)	1
IDP-TMS-RJS-RIBN-4RPSCE	T300-T400 Series Ribbon for heat-shrink sleeves & SB labels, 4.33" wide, 984 (300)	1
IDP-1330-0607-10	T300-T400 Series Ribbon for TTPA, MP, WP, WV labels, 4.33" wide, 984 (300)	1
IDP-TE3112-PRINTER	Ribbon for TE3112 printer, use with HLX-NEL, CM-SCE	

## Raychem Miscellaneous Accessories



C\_IS\_Access

### Selection Information

Catalog Number	Description	Std. Pack
IDP-T200-SPINDLE	Feeds TTPA, MP, WP, SB (standard), and other labels into T208M	1
IDP-PAYOFF-CRADLE	Feeds SHRINKMARK-18/12/10 (2.5K box) and -2/250/1000 (1K box) into T208M	1
IDP-T200-CASE	Hard-sided gray case with foam interior, ideal for travel with T208M Printer	1
CPGI-GLOW-GUN	Flameless heat gun for shrinking ShrinkMark sleeves or thin wall tubing	6





# LOW VOLTAGE SPLICES & TAPS

## Low Voltage In-Line Splices

### Cold-Applied

GelWrap Splice Closures .....	104
GILS In-Line Splices .....	105
Rayvolve RVS Splices .....	105

### Heat-Shrink

MWTM Tubing .....	106
WCSM Tubing .....	107
FCSM Tubing .....	109
CRSM Sleeves .....	110
CRSM CT Cable Tap Splices .....	111
MRS Repair Sleeves .....	112
ALK Splice Sealing Kit .....	113
LVSA-3 Splice .....	113
LV-MSK Splice .....	114

## Low Voltage Stub Splices & Motor Connection Kits

GelCap Splice Covers .....	115
Rayvolve RVC Splice Cover Kits .....	116
MCK Motor Connection Kits .....	117

## Low Voltage Taps

GTAP Splices .....	118
GelCap SL Splice Covers .....	119
GHFC H-Frame Closures .....	120
GelPort Connectors .....	121

## Network Protection

Smart Limiter .....	122
---------------------	-----



C\_GelWrapSC\_lv

## GelWrap Splice Closures

### Water Resistant Wraparound Splice Closures (1000 V)

Raychem GelWrap splice closures quickly and conveniently insulate and seal buried electrical connections rated up to 1000 volts. The robust, yet compact, design is engineered to handle the harsh environments of direct burial and manhole applications. GelWrap splice closures are equally well suited for insulation and jacket repair. GelWrap UF splices include the UF connector.

#### Selection Information: dimensions in inches (millimeters)

Catalog Number	Sleeve Length	Conductor Size	Connector Opening	Max. General Use Diameter Range	Std. Pack
GelWrap-18/4-100	4.0 (100)	#12-4/0 (4-95)	1.0 (25)	0.15-0.70 (4-18)	6
GelWrap-18/4-150	6.0 (150)	#12-4/0 (4-95)	3.0 (75)	0.15-0.70 (4-18)	6
GelWrap-18/4-200	8.0 (200)	#12-4/0 (4-95)	5.0 (125)	0.15-0.70 (4-18)	6
GelWrap-18/4-250	10.0 (250)	#12-4/0 (4-95)	7.0 (175)	0.15-0.70 (4-18)	6
GelWrap-18/4-300	12.0 (300)	#12-4/0 (4-95)	9.0 (225)	0.15-0.70 (4-18)	6
GelWrap-33/10-150	6.0 (150)	#2-500 (35-240)	2.0 (50)	0.40-1.30 (10-33)	6
GelWrap-33/10-200	8.0 (200)	#2-500 (35-240)	4.0 (100)	0.40-1.30 (10-33)	6
GelWrap-33/10-250	10.0 (250)	#2-500 (35-240)	6.0 (150)	0.40-1.30 (10-33)	6
GelWrap-33/10-250-I350M4*	10.0 (250)	#6-350 (16-180)	5 (125)	0.40-1.30 (10-33)	12
GelWrap-33/10-300	12.0 (300)	#2-500 (35-240)	8.0 (200)	0.40-1.30 (10-33)	12
GelWrap-33/10-350	14.0 (350)	#2-500 (35-240)	10.0 (250)	0.40-1.30 (10-33)	10
GelWrap-50/20-200	8.0 (200)	250-750	2.0 (50)	0.80-1.50 (20-38)	12
GelWrap-50/20-250	10.0 (250)	250-750	4.0 (100)	0.80-1.50 (20-38)	12
GelWrap-50/20-300	12.0 (300)	250-750	6.0 (150)	0.80-1.50 (20-38)	12
GelWrap-50/20-350	14.0 (350)	250-750	8.0 (200)	0.80-1.50 (20-38)	12
GelWrap-50/20-400	16.0 (400)	250-750	10.0 (250)	0.80-1.50 (20-38)	12
GelWrap-UF-200	8.0 (200)	14/2-8/3 w/ground	N/A	N/A	10

Notes: UL denotes UL & cUL for submersible applications  
 For other sizes or applications, a minimum seal length is required on each side of connector opening or jacket damage.  
 GelWrap closure 18/4 series 1.5 (38)  
 GelWrap closure 33/10 series 2.0 (51)  
 GelWrap closure 50/20 series 3.0 (75)  
 \*Includes four screw mechanical connector

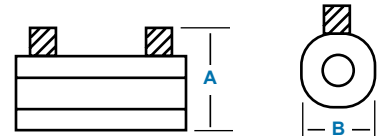

#### UL Listed

Catalog Number	Sleeve Length	1000V Cable Range	Maximum Connector Opening	Maximum Compression Connector Dia.	Maximum Mechanical Connector Dimensions Height* (A)	Width (B)
GelWrap-18/4-150UL	6.0 (150)	#14-4/0 AWG	2.0 (50)	0.85 (22)	1.2 (30)	1.1 (28)
GelWrap-18/4-200UL	8.0 (200)	#14-4/0 AWG	4.0 (100)	0.85 (22)	1.2 (30)	1.1 (28)
GelWrap-18/4-250UL	10.0 (250)	#14-4/0 AWG	6.0 (150)	0.85 (22)	1.2 (30)	1.1 (28)
GelWrap-18/4-300UL	12.0 (300)	#14-4/0 AWG	8.0 (200)	0.85 (22)	1.2 (30)	1.1 (28)
GelWrap-18/4-350UL	14.0 (350)	#14-4/0 AWG	10.0 (250)	0.85 (22)	1.2 (30)	1.1 (28)
GelWrap-18/4-400UL	16.0 (400)	#14-4/0 AWG	12.0 (300)	0.85 (22)	1.2 (30)	1.1 (28)
GelWrap-18/4-450UL	18.0 (450)	#14-4/0 AWG	14.0 (350)	0.85 (22)	1.2 (30)	1.1 (28)
GelWrap-18/4-500UL	20.0 (500)	#14-4/0 AWG	16.0 (400)	0.85 (22)	1.2 (30)	1.1 (28)
GelWrap-18/4-550UL	22.0 (550)	#14-4/0 AWG	18.0 (450)	0.85 (22)	1.2 (30)	1.1 (28)
GelWrap-18/4-600UL	24.0 (600)	#14-4/0 AWG	20.0 (500)	0.85 (22)	1.2 (30)	1.1 (28)
GelWrap-UF-250UL	10.0 (250)	14/2-8/3 w/ground	N/A	N/A	N/A	N/A

\*Height includes screws with cable installed.

#### Product Performance

Testing	Test Conditions
ANSI C119.1	600 V insulated underground
Chemical Resistance	Fluid immersion, 168 hours @ 23°C, 75% elongation retention minimum - 10W-40 motor oil - 10% hydrochloric acid - 15% sodium chloride - 20% sodium hydroxide - ETX 60280 antifreeze (1000 hours)
Accelerated Aging	1000 hours @ 135°C - 93% retention tensile strength - 82% retention elongation at break

#### Ordering Information

- Selection is based on typical dimensions for low-voltage insulated cables.
- Related test reports: EDR-5343-18/4, EDR-5356-33/10, EDR-5367 for 50/20, EDR-5356 for GelWrap-33/10-250-I350M4 (A four screw connector is included). EDR-5356-GelWrap-UF

For connector information refer to the Connectors and Terminals section of this catalog.



C\_GILS\_iv

## Gel In-Line Splices (GILS) Water Resistant Splice Kit for Power Cable (1000 V)

Raychem Gel in-line splice (GILS) kits offer a state-of-the-art sealed splice for underground, buried, and overhead applications. GILS closures offer a fast and simple method for splicing, insulating, and environmentally sealing low-voltage cable splices.

The GILS closure, with its revolutionary PowerGel sealant, covers and seals the splice quickly and easily, saving both time and effort.

Simply install the connector, place on the closure, and snap closed. It's that easy—no tapes, mastic, tools or mixing are required. The splice is ready to bury—no waiting to cure.

- Connector accommodates copper and/or aluminum cables
- Qualified to ANSI C119 for underground splicing
- UV resistant
- Qualified for temperatures from -40°C to 90°C
- Connector included
- RUS accepted connector blocks and splices for secondary.
- Water-tight for use in all locations

### Selection Information

Catalog Number	Conductor Size (AWG/kcmil)	Std. Pack
GILS-4/0	#2-4/0	18 or 72 each
GILS-350	1/0-350	18

### Ordering Information

1. Based on typical dimensions for low-voltage insulated cables.
2. Related test reports: EDR-5298, EDR-5394



C\_RVS\_iv

## Rayvolve RVS Splice Covers “Roll-on” Splices for 1/C Power Cable (1000 V)

Raychem RVS splice cover kits are the easy “roll-on” way to insulate and seal cable connections up to 1000 V. The gripping force of the specially formulated EPDM elastomer combines with the high-performance sealant to form a water-resistant, insulating sleeve that is UL listed and CSA certified for direct burial application over in-line compression connectors.

RVS splice cover sleeves feature a dual-wall design with an entrapped lubricant, making installation fast and simple. The elastomeric sleeve rolls onto the cable with minimal effort, even at temperatures below -15°F (-25°C). The cable can be energized immediately. It is ideal for use where gas or electric heating devices are not approved.



Qualified to ANSI C119.1. CSA certified to C22.2 No. 198.2. UL listed per 96J4 (file E91151). RUS accepted for use as a secondary tap or splice cover. For use on standard poly- or elastomeric-insulated cables. Use to insulate and seal in-line compression connectors or to seal terminal lugs.

### Selection Information: dimensions in inches (millimeters)

Catalog Number	Conductor Size (AWG/kcmil)	Cable O.D. (Min.–Max.)	Sleeve Length	Maximum Connector Length
RVS-11	#8-2/0	.22-.68 (6-17)	8.0 (205)	5.00 (127)
RVS-12	1/0-250	.50-.90 (13-23)	9.5 (241)	4.50 (114)
RVS-13	250-600	.70-1.20 (18-30)	12.0 (305)	7.00 (178)
RVS-14	600-1000	.95-1.50 (24-38)	14.0 (356)	9.00 (229)

### Ordering Information

1. Select the appropriate catalog number. Selections are based on typical dimensions of low-voltage insulated cable. Confirm selection with dimensions to assure proper sizing.
2. Kits do not contain connectors. The RVS splice cover selection information mentioned above covers copper and aluminum in-line compression connections.
3. Each kit contains one Rayvolve RVS splice cover sleeve and sealant strips.
4. Standard package: 5 kits/box or 50 kits/box.
5. Related test report: EDR-5167.

## Low Voltage In-Line Heat-Shrink Splices



C\_MWTM\_lv

## Raychem MWTM Tubing

### Medium-Wall Sealant-Coated or Uncoated Tubing (600 V)

- Sealant-coated MWTM tubing (-S designation) is for use as insulation/jacket repair up to 600 V or for general sealing and re-jacketing of polymeric- or elastomeric-insulated cables up to 35 kV
- RUS accepted as jacket restoration of JCN cable
- Uncoated MWTM tubing (-U or -A/U) is for cable re-jacketing only
- 3:1 shrink ratio and an unlimited shelf life when stored under normal conditions

#### Selection Information: dimensions in inches (millimeters)

Catalog Number	Use Range (Min.-Max.)	Cut-Piece Length	Min. Cont. Length	Std. Package		
				Box	Spool	Bulk Spool
<b>Sealant-Coated, Cut-Length Tubing</b>						
MWTM-10/3-1200-S	0.13-0.35 (3-9)	48 (1200)		25		
MWTM-16/5-1200-S	0.25-0.55 (6-14)	48 (1200)		25		
MWTM-25/8-1200-S	0.35-0.85 (9-22)	48 (1200)		25		
MWTM-35/12-1200-S	0.50-1.25 (13-32)	48 (1200)		25		
MWTM-50/16-1200-S	0.65-1.70 (17-43)	48 (1200)		15		
MWTM-85/25-1200-S	1.00-2.90 (25-74)	48 (1200)		5		
MWTM-115/34-1200-S	1.40-3.90 (36-99)	48 (1200)		5		
MWTM-140/42-1200-S	1.80-4.70 (46-119)	48 (1200)		5		
<b>Uncoated, Spooled Tubing</b>						
MWTM-10/3-A/U	0.13-0.35 (3-9)		25 (7.6)		100 (30)	
MWTM-16/5-A/U	0.25-0.55 (6-14)		25 (7.6)		100 (30)	1155 (350)
MWTM-25/8-A/U	0.35-0.85 (9-22)		25 (7.6)		100 (30)	660 (200)
MWTM-35/12-A/U	0.50-1.25 (13-32)		25 (7.6)		100 (30)	495 (150)
MWTM-50/16-A/U	0.65-1.70 (17-43)		15 (4.6)		75 (23)	330 (100)
<b>Uncoated, Cut-Piece Tubing</b>						
MWTM-85/25-1500/U	1.00-2.90 (25-74)	60 (1500)		5		
MWTM-115/34-1500/U	1.40-3.90 (36-99)	60 (1500)		5		
MWTM-140/42-1500/U	1.80-4.70 (46-119)	60 (1500)		5		

#### Ordering Information

1. Select the appropriate catalog number. Confirm selection with application dimensions to assure proper sizing.
2. MWTM is a general purpose tubing; for sealing applications use MWTM with sealant (-S) or use uncoated MWTM (-U or -A/U) in combination with S-1052 sealant. Order sealants separately.
3. For testing information refer to the Technical Data section of this catalog.
4. UV resistant test report: EDR-5361.  
*For connector information refer to the Connectors and Terminals section of this catalog.*



C\_WCSM\_IV

## Raychem WCSM Tubing Heavy-Wall Sealant Coated Tubing (1000 V)

- For use on standard poly or elastomeric insulated / jacketed cable or lead-jacketed cables, which may include aluminum or steel armoring.
- WCSM tubing can be used to seal an in-line splice or terminal lug seal for non-flame retardant applications, cable re-jacketing and mechanical protection.
- WCSM tubing sizes 12-3 through 70-20 is UL and cUL listed per 486D (file E91151).
- Qualified to ANSI C119.1 and rated to Western Underground guide 2.5. Also RUS accepted for use as a secondary tap or splice cover, and for use as jacket restoration materials on JCN cable.
- WCSM tubing may be used for jacket repair on cables up to 35 kV.
- WCSM tubing has a 4:1 shrink ratio and an unlimited shelf life when stored under normal conditions.

*Note: UL listing applies to WCSM 12/3 through 70/20 only. WCSM 110/30 and 130/35 have not been evaluated to the UL standards. WCSM is no longer offered as an uncoated option. You can substitute either WCSM coated or MWTM uncoated depending on which will work for your application.*

### Selection Information: dimensions in inches (millimeters)

Catalog Number Tubing Size	1000 V Cable Nominal Use Range AWG/kcmil		Maximum Connector OD	UL Conductor Use Range Min-Max	General Conductor Use Range Min-Max	Maximum Connector Opening "A"	Minimum Seal Length per Side
	Min	Max					
WCSM-12/3-150-S	#14	#6	0.29	13-30 (3.5-7.7)	13-39 (3.5-10)	2.4	1.5
WCSM-12/3-300-S	#14	#6	0.29	13-30 (3.5-7.7)	13-39 (3.5-10)	7.8	1.5
WCSM-12/3-1200-S	#14	#6	0.29	13-30 (3.5-7.7)	13-39 (3.5-10)	39.3	1.5
WCSM-16/4-150-S	#8	#2	0.41	17-41 (4.5-10.5)	17-55 (4.5-14)	1.4	2
WCSM-16/4-300-S	#8	#2	0.41	17-41 (4.5-10.5)	17-55 (4.5-14)	6.8	2
WCSM-16/4-1200-S	#8	#2	0.41	17-41 (4.5-10.5)	17-55 (4.5-14)	38.3	2
WCSM-24/6-150-S	#6	#4/0	0.69	25-64 (6.5-16.5)	25-86 (6.5-22)	1.4	2
WCSM-24/6-225-S	#6	#4/0	0.69	25-64 (6.5-16.5)	25-86 (6.5-22)	3.96	2
WCSM-24/6-300-S	#6	#4/0	0.69	25-64 (6.5-16.5)	25-86 (6.5-22)	6.8	2
WCSM-24/6-1200-S	#6	#4/0	0.69	25-64 (6.5-16.5)	25-86 (6.5-22)	38.3	2
WCSM-34/8-150-S	#2	500	1.06	35-94 (9-24)	35-122 (9-31)	1.4	2
WCSM-34/8-200-S	#2	500	1.06	35-94 (9-24)	35-122 (9-31)	3.02	2
WCSM-34/8-225-S	#2	500	1.06	35-94 (9-24)	35-122 (9-31)	3.96	2
WCSM-34/8-300-S	#2	500	1.06	35-94 (9-24)	35-122 (9-31)	6.8	2
WCSM-34/8-1200-S	#2	500	1.06	35-94 (9-24)	35-122 (9-31)	38.48	2
WCSM-48/12-150-S	#2/0	750	1.3	51-112 (13-28.5)	51-173 (13-44)	1.4	2
WCSM-48/12-225-S	#2/0	750	1.3	51-112 (13-28.5)	51-173 (13-44)	3.96	2
WCSM-48/12-300-S	#2/0	750	1.3	51-112 (13-28.5)	51-173 (13-44)	6.8	2
WCSM-48/12-1200-S	#2/0	750	1.3	51-112 (13-28.5)	51-173 (13-44)	38.3	2
WCSM-56/16-225-S	250	1000	1.5	68-127 (17.5-32.5)	70-196 (17.5-50)	3.96	2
WCSM-56/16-300-S	250	1000	1.5	68-127 (17.5-32.5)	70-196 (17.5-50)	6.62	2
WCSM-56/16-1200-S	250	1000	1.5	68-127 (17.5-32.5)	70-196 (17.5-50)	38.3	2
WCSM-70/20-300-S	500	1500	1.84	92-140 (22-35.8)	86-248 (22-63)	5.8	2.5
WCSM-70/20-450-S	500	1500	1.84	92-140 (22-35.8)	86-248 (22-63)	10.93	2.5
WCSM-70/20-600-S	500	1500	1.84	92-140 (22-35.8)	86-248 (22-63)	16.26	2.5
WCSM-70/20-1200-S	500	1500	1.84	92-140 (22-35.8)	86-248 (22-63)	37.3	2.5
WCSM-110/30-300-S	1250	2000	-	-	1.29-3.93 (33-100)	-	2.5
WCSM-110/30-1200-S	1250	2000	-	-	1.29-3.93 (33-100)	-	2.5
WCSM-130/35-300-S	1500	2500	-	-	1.49-4.64 (39-118)	-	2.5
WCSM-130/35-450-S	1500	2500	-	-	1.49-4.64 (39-118)	-	2.5
WCSM-130/35-1200-S	1500	2500	-	-	1.49-4.64 (39-118)	-	2.5

Length tolerance to +2 percent.

Can be used for multi-conductor LV splices using different tubings

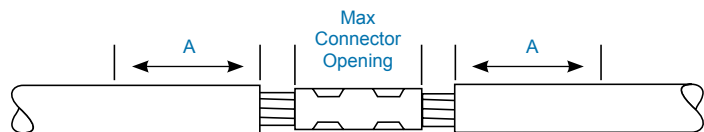

## Low Voltage In-Line Heat-Shrink Splices

### Ordering Information

1. Select the appropriate catalog number based on typical dimensions for low-voltage insulated cable. Confirm selection with dimensions to assure proper sizing. For general conductor use or UL conductor use.
2. Package does not contain connectors or lugs. Installed connector or lug diameter must be within use range.
3. WCSM tubing may be field-cut for shorter requirements
4. Bulk packaging is available for cut lengths. Consult your TE representative for more information.
5. UL listing applies to WCSM 12/3 through 70/20 only. WCSM 110/30 and 130/35 are not UL listed.
6. Related test reports: EDR 5541, PII 56428

*For connector information refer to the Connectors and Terminals section of this catalog.*



Wire Connector System for Use  
With Underground Connectors  
96J4



C\_FCSM\_lv

## FCSM Tubing Heavy-Wall Flame Retardant Tubing (2000 V)

Raychem FCSM tubing's tough, crosslinked polyolefin construction provides mechanical strength and cut-through resistance equal to, or surpassing, the properties of low-voltage cable jackets.

- 3:1 shrink ratio and an unlimited shelf life when stored under normal conditions
- Use sealant-coated tubing (-S) as a sealed in-line splice or terminal lug seal. It provides a water-tight seal for direct-buried applications and wet environments.
- Use uncoated tubing (-U) for cable rejacketing only
- Sealant-coated or uncoated tubing may be used for jacket repair on cable to 35 kV. Qualified to ANSI C119.1 also rated to IEEE 383 (Vertical Tray Flame Test) and ICEA S-19-81.
- FCSM is also MSHA approved (No. 07-KA090013-MSHA).

For use on standard poly- or elastomeric- insulated/jacketed cables or lead-jacketed cables, which may include aluminum or steel armoring.

Connectors up to 6 inches: Recommended cut length = connector length + 4 inches.

Connectors over 6 inches: Recommended cut length = connector length + 5 inches.

### Selection Information: dimensions in inches (millimeters)

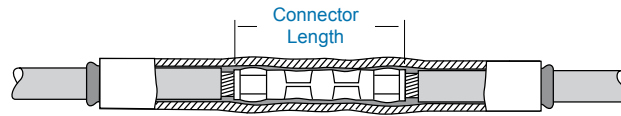

Catalog Number	2000 V Insulated Conductor Size (AWG/kcmil)	General Use Range (Min.-Max.)	Tube Length*	Std. Ft.(m)/Roll	Pack Pcs/Box	Bulk Option Ft.(m)/Roll
<b>In-Line Splice Or Terminal Lug Seal (With Sealant)</b>						
FCSM-9/3-1200-S	#14-#8	0.15-0.30 (4-8)	48 (1200)		25	
FCSM-19/6-150-S	#6-#2	0.25-0.65 (6-17)	6 (150)		50	
FCSM-19/6-1200-S	#6-#2	0.25-0.65 (6-17)	48 (1200)		25	
FCSM-28/9-225-S	#2-4/0	0.40-0.95 (10-24)	9 (225)		50	
FCSM-28/9-1200-S	#2-4/0	0.40-0.95 (10-24)	48 (1200)		25	
FCSM-38/12-300-S	1/0-350	0.50-1.30 (13-33)	12 (300)		40	
FCSM-38/12-1200-S	1/0-350	0.50-1.30 (13-33)	48 (1200)		10	
FCSM-51/16-300-S	250-500	0.70-1.75 (18-44)	12 (300)		30	
FCSM-51/16-1200-S	250-500	0.70-1.75 (18-44)	48 (1200)		10	
FCSM-68/22-1200-S	600-1000	0.95-2.30 (25-58)	48 (1200)		10	
FCSM-90/30-1200-S	800-1200	1.30-3.10 (33-79)	48 (1200)		5	
FCSM-120/40-1200-S	1500-2500	1.75-4.10 (44-104)	48 (1200)		5	
FCSM-177/63 600-S		2.75-6.05 (70-154)	24 (600)		6	
FCSM-177/63-1200-S		2.75-6.05 (70-154)	48 (1200)		5	

### Cable Rejacketing (Without Sealant)

FCSM-9/3-A/U	#14-#8	0.15-0.30 (4-8)		100 (30)		
FCSM-19/6-A/U	#6-#2	0.25-0.65 (6-17)		100 (30)		825 (250)
FCSM-28/9-A/U	#2-4/0	0.40-0.95 (10-24)		65 (20)		495 (150)
FCSM-38/12-A/U	1/0-350	0.50-1.30 (13-33)		50 (15)		395 (120)
FCSM-51/16-A/U	250-500	0.70-1.75 (18-44)		40 (12)		330 (100)
FCSM-68/22-A/U	600-1000	0.95-2.30 (25-58)		80 (24)		
FCSM-90/30-1500/U	800-1200	1.30-3.10 (33-79)	60 (1500)		5	
FCSM-120/40-1500/U	1500-2500	1.75-4.10 (44-104)	60 (1500)		5	
FCSM-177/63-1500/U		2.75-6.05 (70-154)	60 (1500)		5	

\*Length tolerance to ±2 percent.

### Ordering Information

1. Select the appropriate catalog number based on typical dimensions for low-voltage insulated cable. Confirm selection with cable dimensions to assure proper sizing.
2. Connectors or lugs not included.
3. If sealing is needed with uncoated FCSM tubing (-U), order S-1052 separately.
4. Tubing may be field-cut for shorter requirements.
5. Bulk packaging is available for cut-lengths. Contact your TE Connectivity representative for additional information.
6. For testing information refer to the Technical Data section of this catalog.
7. Related test reports: EDR-5133, EDR-5134, EDR-5141. *For connector information refer to the Connectors and Terminals section of this catalog.*



C\_CRSM\_lv

## CRSM Sleeves Heat-Shrink Wraparound Sleeve (1000 V)

Raychem CRSM sleeves close easily with a permanent locking system that consist of a raised rail profile and a stainless steel channel. These sleeves are made from crosslinked polyolefin, which equals or exceeds the material properties of the original cable jacket. CRSM sleeves fit a wide range of cable sizes and have unlimited shelf life, when stored under normal conditions.

- Qualified to ANSI C119.1 rated to ICEA electrical withstand test for 1000 V. RUS accepted for use as jacket restoration materials on JCN cable.
- For use on standard poly- or elastomeric insulated/jacketed cables or lead-jacketed cables, which may include aluminum or steel armoring.
- Use as insulation for 1/C low-voltage power cable up to 1000V and for jacket repair up to 35 kV or for general sealing applications. All CRSM sleeves are sealant-coated.

### Selection Information: dimensions in inches (millimeters)

Catalog Number	Sleeve Length	Primary Electrical Repair (1000 V) Cable and Jacket Repair Conductor Size Use Range (AWG/kcmil) (Min.–Max.)		General Sealing Use Range (0–35 kV) (Min.–Max.)	Std. Pack
CRSM 34/10-200	08 (200)	#8-2/0	0.25-0.60 (6-15)	0.25-1.20 (6-30)	3
CRSM 34/10-1200	48 (1219)	#8-2/0	0.25-0.60 (6-15)	0.25-1.20 (6-30)	5
CRSM 53/13-200	08 (200)	3/0-400	0.60-0.95 (15-24)	0.60-1.80 (15-46)	10
CRSM 53/13-1200	48 (1219)	3/0-400	0.60-0.95 (15-24)	0.60-1.80 (15-46)	5
CRSM 84/20-750	30 (750)	500-1000	0.95-1.40 (24-36)	0.95-2.70 (24-69)	10
CRSM 84/20-1200	48 (1219)	500-1000	0.95-1.40 (24-36)	0.95-2.70 (24-69)	5
CRSM 107/29-1000	40 (1000)	1000-2000	1.30-2.00 (33-51)	1.30-3.60 (33-91)	10
CRSM 107/29-1200	48 (1219)	1000-2000	1.30-2.00 (33-51)	1.30-3.60 (33-91)	5
CRSM 143/36-1200	48 (1219)			1.65-4.95 (42-126)	5
CRSM 198/55-1200	48 (1219)			2.50-6.50 (64-165)	5

### Ordering Information

1. Select the appropriate catalog number for either primary electrical repair (1000 volts max.) or general sealing applications. Electrical repair selections are based on typical dimensions for low-voltage insulated cable. Confirm selection with cable dimensions to assure proper sizing.
2. Use the "Primary electrical repair" columns for electrical repair applications (when CRSM is in direct contact with the conductor).
3. Use the "General sealing and jacket repair use range" column for general re-jacketing or sealing applications (when CRSM is not in direct contact with the conductor).
4. Package does not contain connectors.
5. Kits include a wraparound sleeve and stainless steel channel closure. Both can be field-cut for shorter requirements (see "Reference dimensions" below).
6. Related test report: EDR-5124, EDR-5192.
7. UV resistant test report: EDR-5361.
8. CRSM 34/20 are available in shorter standard lengths by ordering the corresponding CRSM-CT kits. (The use ranges in the selection information table still apply).

*For connector information refer to the Connectors and Terminals section of this catalog.*

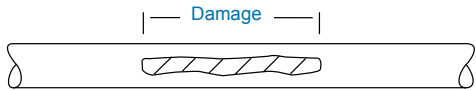

Cut sleeve length = Damage length + total seal length

Damage	Total Seal Length
<3 (<76)	3 (76)
3-12 (76-305)	4 (102)
12-24 (305-610)	6 (152)
>24 (>610)	8 (203)





C\_CRSM\_CT\_IV

## Raychem CRSM CT Cable Tap Splices Heat-Shrink Wraparound Cable Tap Splices (1000 V)

- Use as a wraparound, sealed cable tap splice
- Qualified to ANSI C119.1 rated to ICEA electrical withstand test for 1000 volts
- RUS accepted for use with compression and split-bolt connectors
- Sealant-coated
- For use on standard poly- or elastomeric insulated conductors

### Selection Information: dimensions in inches (millimeters)

Catalog Number	Sleeve Length	Conductor Size (1000 V max.)		Connector Dimension (Max. D)	Std. Pack
		Main (AWG/kcmil)	Tap (AWG/kcmil)		
<b>Compression connector</b>					
CRSM-CT-34/10-150	6 (152)	#8-#2	#10-#2	2 (51)	10
CRSM-CT-53/13-200	8 (203)	#2-4/0	#10-4/0	4 (102)	10
CRSM-CT-84/20-250	10 (254)	4/0-500	#2-500	6 (152)	10
<b>Standard split-bolt connector</b>					
CRSM-CT-53/13-200	8 (203)	#8-#2	#14-#2	1.5 (38)	10

### Ordering Information

1. Select the appropriate catalog number based on the main and tap conductor sizes and connector type for electrical repair (1000 volts max.). Selections are based on typical dimensions for low-voltage insulated cable. Confirm selection with cable dimensions to assure proper sizing.
  2. Kits are capable of insulating and sealing wye (3-wire) or H (4-wire) configurations up to 1000 volts.
  3. Kits do not contain connectors.
  4. Kits include insulating sleeve, sealant strip, and stainless steel channel closure.
  5. Standard package: 10 kits/box.
  6. Related test report: EDR-5192.
  7. UV resistant test report: EDR-5361.
- For connector information refer to the Connectors and Terminals section of this catalog.*

Compression connector

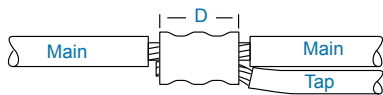

Split-bolt connector

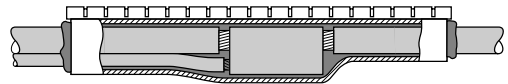
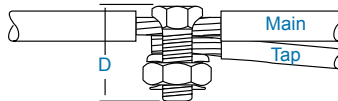



C\_MRS\_RS\_lv

## MRS Repair Sleeves Heat-Shrink Wraparound Flame-Retardant Sleeve (2 kV)

Raychem MRS wraparound mining repair sleeve provides an efficient method of repairing insulation on flexible cables to 2 kV and repairing jacket damage on high-voltage cable where a splice is not required.

Specially formulated, flame-retardant, flexible wraparound sleeve installs with a low profile quickly and easily, which means the cable can be returned to service in minutes. Ideal for use on trailing cable as well as flexible-construction cables and conduits. MSHA approved (No. P-137-MSHA).

### Selection Information: dimensions in inches (millimeters)

Catalog Number	Cable use Range (Min.-Max.)	Sleeve Length	Std. Pack (Kits/Box)
MRS-12-10	1.00-1.60 (25-41)	10 (254)	20
MRS-12-24	1.00-1.60 (25-41)	24 (610)	10
MRS-34-24	1.60-2.30 (41-58)	24 (610)	10
MRS-34-30	1.60-2.30 (41-58)	30 (762)	10
MRS-56-30	2.30-3.50 (58-89)	30 (762)	10

*Kits do not contain connectors.*

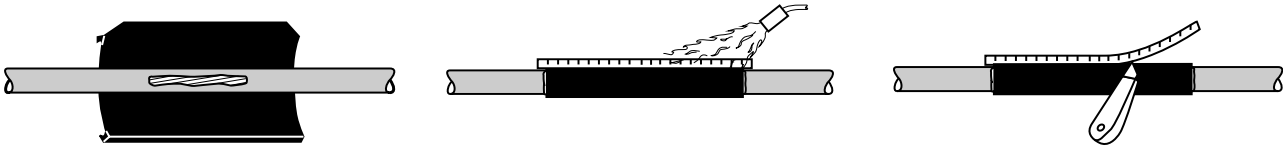

Damage Total	Seal Length
<3 (< 76)	3 (76)
3-12 (76-305)	4 (102)
12-24 (305-610)	6 (152)
>24 (> 610)	8 (203)

### Ordering Information

1. Select the appropriate catalog number based on cable diameter.
2. Kits do not contain connectors.
3. MRS repair sleeve is precoated with adhesive.
4. Kits contain a wraparound sleeve and stainless steel channel closure (removed after installation). Both can be field-cut for shorter requirements.
5. Related test report: EDR-5028.

*For connector information refer to the Connectors and Terminals section of this catalog.*



C\_ALK\_lv

### Raychem ALK Splice Sealing Kit Heat-Shrink Airport Lighting Kit

These environmental sealing kits enhance the ability of type L-823 plug and receptacle connectors to meet FAA specifications.

**Selection Information: dimensions in inches (millimeters)**

Catalog Number	Cable/Connector Diameter (Min. – Max.)	Std. Pack (Kits/Box)
ALK-L823	0.50-1.50 (13-38)	10

*Kits do not contain connectors.*

*Suitable for use on FAA-type L-823 connectors.*

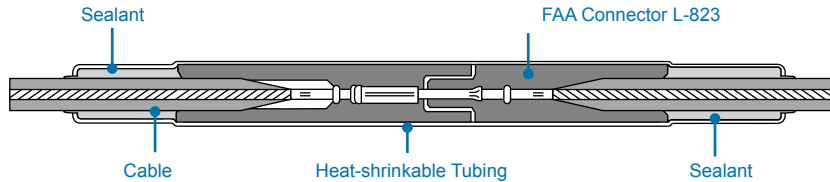

C\_LVSA-3\_lv

### LVSA-3 Splice Heat-Shrink Splices for 3/C Armored Cable (1000 V)

The Raychem LVSA-3 splice kit features a wraparound, heat-shrinkable, adhesive-coated outer sleeve that significantly reduces the installation space required and protects the splice from corrosion and moisture.

- Kits include a low-profile wraparound armor case that is simple to install and requires no compound or resin filling.
- Qualified to ANSI C119.1. For splicing 3/C polymeric, armored (corrugated or interlocked-type) power and control cables (600–1000 volts).

**Selection Information: dimensions in inches (millimeters)**

Catalog Number	Conductor Size Range (AWG/kcmil)	Cable O.D. (Min.–Max.)	Maximum Connector Length	Std. Pack
LVSA-3-1	#6-#2	0.60-1.50 (15-38)	3.50 (89)	1
LVSA-3-2	#1-4/0	0.90-2.20 (23-56)	4.00 (102)	1
LVSA-3-3	250-500	1.20-3.00 (30-76)	5.00 (127)	1
LVSA-3-4	600-1000	1.50-3.80 (38-97)	7.00 (178)	1

*Kits do not contain connectors; please order them separately.*

*CRSM can be used if wraparounds are required.*

*For connector information refer to the Connectors and Terminals section of this catalog.*



C\_LV-MSK\_iv

## LV-MSK Splice Heat-Shrink Flexible Mining Cable (600 V-2 kV)

Raychem LV-MSK kits are flame-retardant, in-line and multi-conductor splice kits for use on mining cables and standard flexible cables up to 2 kV

- MSHA approved to P-137-4--MSHA
- For types G, W, G-GC, and SHD-GC round and flat cables



### Selection Information: dimensions in inches (millimeters)

Catalog Number	Cable Diameter (Min.-Max.)	Power Conductor Size (AWG/kcmil)			Std. Pack (Kits/Box)
		G or G-GC 3/C	W or G 2/C	W 4/C	
<b>LV-MSK (600 V-2 kV) - Flat cables</b>					
LV-MSK-046	0.85-1.40 (22-36)		#6-#2		15
LV-MSK-047	1.30-2.40 (33-61)	#6-#1	#1-4/0	#6-#1	10
LV-MSK-058	1.60-3.15 (41-80)	#2-4/0		#2-4/0	5
<b>Round cables</b>					
LV-MSK-045	0.85-1.40 (22-36)	#8-#6	#8-#6		20
LV-MSK-046	0.85-1.40 (22-36)	#6-#2	#6-#4		15
LV-MSK-047	1.30-2.40 (33-61)	#2-3/0	#3-3/0	#6-1/0	10
LV-MSK-058	1.60-3.15 (41-80)	2/0-500	2/0-350	1/0-350	5

### Ordering Information

1. Kits do not contain connectors; please order separately.
2. LV-MSK-045 has a lower profile than LV-MSK-046.
3. Standard package: LV-MSK: See selection tables above. HV-MSK: One 3/C kit per box.
4. If 8 kV is required see HV-MSK.

*For connector information refer to the Connectors and Terminals section of this catalog.*



C\_GelCap\_lv

## GelCap Splice Covers Water Resistant Stub Splice Cover Kit (1000 V)

Raychem GelCap splice cover kits quickly and conveniently insulate, seal, and protect stub splice connections up to 1000 volts. The robust, yet compact, design was engineered to handle the harsh environments of motor connections. GelCap splice cover kits are equally well suited for many other connection applications including street light connections. The specially formulated material provides excellent abrasion resistance and insulation value.

Each cap size is designed to fit a wide range of cable sizes. The expandable design keeps the cap as small as possible and allows it to expand only as much as needed to fit on large cable.

GelCap splice cover kits provide the fastest installation. Simply push the cover down over the connection and snap the clamp closed. No extra materials or greases are required. The PowerGel sealant is already in the cap. Removal is just as quick and easy as installation.

### Selection Information: dimensions in inches (millimeters)

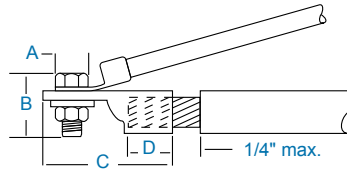

Catalog Number	Feeder Conductor Size (mm)	Max. Bolt Dimensions		Max. Lug Dimensions Total Length	Barrel Length	Cap length (Nominal)	Std. Pack
		Width A	Length B				
GelCap 1*	#16-#10 AWG (1.5-5)	.375 (10)	.500 (13)	1.00 (25)	0.5 (13)	2.8 (71)	5
GelCap 2	#8-#2 AWG (8-35)	.625 (16)	1.00 (25)	2.00 (51)	1.0 (25)	3.5 (89)	5
GelCap 3	#2-#4/0 AWG (35-105)	.850 (22)	1.30 (33)	3.00 (76)	1.5 (38)	6.0 (152)	5
GelCap 4	250-500 kcmil (125-250)	1.100 (28)	1.85 (47)	5.00 (127)	2.0 (51)	8.0 (203)	5

\* For wire sizes #16 – #10, the unique design of the GelCap 1 splice kit saves space by allowing all three phase connections to be installed in one cover. Note: GelCap 1 kit contains one GelCap cover only. For GelCap splice kits sizes 2-4, one cap per phase is provided.

### Product Performance

Testing	Test Conditions
Chemical Resistance	ASTM D543, Sulfuric acid, Sodium hydroxide and motor oil
Ozone Resistance	ASTM D1149, 168 hours @40°C, 50pphm
Accelerated Aging	ASTM D2671
Abrasion Resistance	2040 gm wt., 4000 cycles, 2% max thickness loss

### Ordering Information

- Selection based on typical dimensions of low-voltage insulated cables.
- Kits do not contain connectors.
- Related test report: EDR-5435.
- ANSI C119.1  
*For connector information refer to the Connectors and Terminals section of this catalog.*

Silicone gel is high dielectric insulation and provides constant pressure on cable and connector to provide waterseal. PowerGel sealant is specially formulated for high temperature environments.

Snap-lock feature provides quick installation and removal.

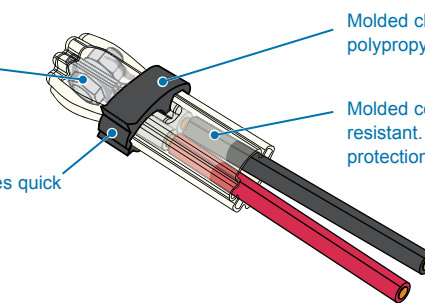

Molded clamp of UV stable, impact resistant polypropylene secures cover in place.

Molded cover is abrasion and impact resistant. Elastomer provides rugged protection for electrical connection.





C\_RVC\_lv

## Rayvolve RVC Splice Cover Kits “Roll-on” Stub Connection Insulation Kits (1000 V)

Raychem RVC splice cover kits offer the quick and easy “roll-on” way to insulate and seal stub connections in motors and street lights up to 1000 volts. The elastomeric RVC cap splice cover provides the required insulation thickness, withstands abrasion, and forms a water-resistant seal. The tool-free RVC cap is ideal for installation in cramped motor boxes. It slides on easily and will not leak, unravel, or slip off.

### Selection Information: dimensions in inches (millimeters)

Catalog Number	Feeder Size (AWG/kcmil)	Bolt Dimensions		Lug Length (Max.)	Cap Length (Nominal)	Std. Pack
		Size (Max.)	Length (Max.)			
<b>Motor connections or two-wire stub splices</b>						
RVC-1V	#14-#4	.375 (8)	.625 (15)	1.75 (45)	3.00 (75)	5
RVC-2V	#8-2/0	.375 (8)	.750 (20)	2.75 (70)	4.00 (100)	5
RVC-3V	#2-4/0	.500 (12)	1.00 (25)	3.00 (75)	5.25 (130)	5
RVC-4V	250-500	.625 (16)	1.50 (35)	5.00 (125)	7.50 (190)	5

Catalog Number	Conductor Size (AWG/kcmil)	Insulation	
		Length (Max.)	Cut-Back (Max.)
<b>Three-wire stub splices</b>			
RVC-1V	#14-#8	1.75 (44)	
RVC-2V	#6-#2	2.75 (70)	



LISTED 96J4  
Direct burial insulation  
covered for listed  
pressure connectors



Certified C22.2  
No. 198.2

Qualified to ANSI  
C119.1-1986. CSA  
certified to C22.2 No.  
198.2. UL listed per  
96J4 (file E91151).

### Ordering Information

1. Select the appropriate catalog number. Selections are based on typical dimensions of low-voltage insulated cable. Confirm selection with dimensions to assure proper sizing.
2. Kits do not contain connectors. The RVS splice cover selection information above covers copper and aluminum in-line compression connections.
3. Each kit contains one Rayvolve RVS splice cover sleeve and sealant strips.
4. Standard package: 5 kits/box.
5. Related test report: EDR-5167.

*For connector information refer to the Connectors and Terminals section of this catalog.*



C\_MCK\_IV

## Raychem MCK Motor Connection Kits Heat-Shrink Motor Connection Kits for 1/C (2000 V)

- Qualified to ANSI-C119.1 and rated to ICEA electrical withstand test for 1000 V
- For use as an in-line or stub splice between 1/C poly feeder cable and motor leads
- Excellent insulation sealing—and resistance to abrasion—in motor connections

### Type V

The stub “Type V” kit is designed to splice the stub or butt configuration that is commonly used where there is insufficient room to make in-line connections.

### Type L

The In-Line “Type L” kit is used, where space permits, to splice in-line connections.

#### Selection Information: dimensions in inches (millimeters)

Catalog Number	Motor Feeder Size (AWG/kcmil)	Bolt Length (Max.)	Connection Length (Max.) H	Length (Nominal)	Std. Pack
				<b>Cap</b>	
<b>Stub Type V</b>					
MCK-1V	#14-#10	.625	2.0 (51)	2.5 (64)	5
MCK-2V	#12-#4	.75	2.5 (64)	3.4 (86)	5
MCK-3V	#2-4/0	1	3.5 (89)	4.5 (114)	5
MCK-4V	250-500	1.5	4.5 (114)	6.5 (165)	5
				<b>Sleeve</b>	
<b>In-Line Type L</b>					
MCK-1L	#8-4/0	1.25	5.0 (127)	9.0 (229)	
MCK-2L	250-1000	1.25	8.0 (203)	12.0 (305)	

Notes: MCK motor connection kits are designed for single-hole connectors and include caps and sealant strips for three connections. Kits do not contain connectors.

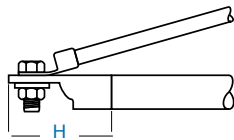

Type V  
Stub configuration

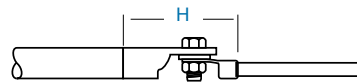

Type L  
In-line configuration

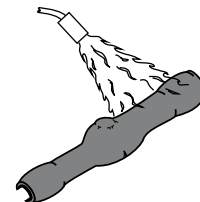

#### Ordering information

1. Select appropriate catalog number based on the motor feeder cable. Motor pigtail leads of the same size or smaller are suitable. MCK selections are based on the typical dimensions of low-voltage insulated cable. MCK selections are based on the typical dimensions of 100% insulated cables manufactured in accordance with the data contained in AEIC CS5 and AEIC CS6, as well as the dimensions of commonly used connectors. Nominal insulation thickness (100%): 90 mils. For cables manufactured to other specifications, confirm selection with cable and connector dimensions.
2. Shielded cable must be terminated before installing MCK.
3. MCK kits are designed for single-hole connectors and include caps and sealant strips for three connections. Kits do not contain connectors.
4. Related test report: MCK: EDR-5110.  
*For connector information refer to the Connectors and Terminals section of this catalog.*



C\_GTAP\_IV

## GTAP Splices Water Resistant Splice (1000 V)

The Raychem GTAP gel tap splice kit provides a fast and simple method for connecting, insulating, and environmentally sealing low-voltage splices. The GTAP splice kit is designed for underground as well as overhead environments. It is especially useful for street lighting applications.

- Range-taking mechanical connectors splice a wide range of cables, including copper and aluminum
- Connector's four port design allows maximum inventory flexibility
- Hinged closure allows for one-step installation
- Can be installed over the connector in seconds by simply snapping the cover shut
- Utilizes TE Connectivity's innovative PowerGel sealant to protect the connection from moisture ingress, corrosion, and pollution
- PowerGel sealant provides additional insulation

### Selection Information: dimensions in inches (millimeters)

Catalog Number	Conductor Size (All Outlets)	Length	Width	Height	Std. Pack
	AWG (mm <sup>2</sup> )				
GTAP-1	#14-#2 (2-35)	2.75 (70)	1.625 (41)	1.0625 (27)	18 or 72
GTAP-2	#14-2/0 (2-70)	4.25 (108)	2 (51)	1.1875 (30)	18 or 72

### Ordering Information

1. Selection based on typical dimensions of low-voltage insulated cables.

Molded cover of UV stable, impact resistant polypropylene provides rugged protection for underground or overhead applications.

Range-taking mechanical connector made of aluminum. Accepts both copper and aluminum conductors.

Frangible fingers provide wide cable range.

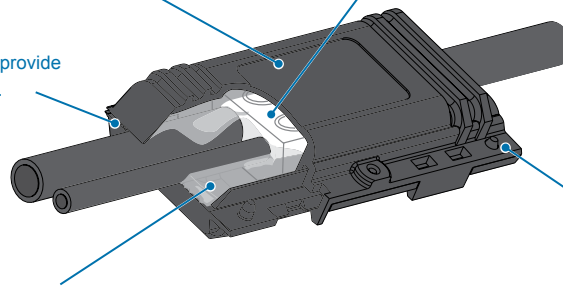

Snap-lock ensures that cover remains closed.

Silicone gel is high dielectric insulation and provides constant pressure on cable and connector to provide waterseal. PowerGel sealant is specially formulated for high temperature environments.





C\_GelCap\_SL\_iv

## GelCap SL Splice Covers for Street Lights Water Resistant Cover Kit with Connector (1000 V)

TE Connectivity's Raychem GelCap SL splice cover kits provide quick installation, dependable performance, and easy reentry for street lighting connections, but they have many other uses.

GelCap SL splice cover kits quickly and conveniently insulate and protect stub splice connections up to 1000 volts.

### PowerGel Sealant Technology

The GelCap SL splice cover kits feature revolutionary PowerGel sealant which provides an excellent moisture seal over a wide temperature range (-40°C to 105°C).

### Innovative Cap Design and Material

The specially formulated material provides abrasion resistance and insulation.

### Range Taking Connector

The special three wire connector is perfect for street light connections. There are two ports that accept wires from #14-2/0 AWG. Use these for the feeder cable. There is a single port that accepts #14-6 AWG. Use this port to power the light.

### Fast and Easy Installation

GelCap SL splice cover kits provide the fastest installation. Simply push the cover down over the connection and snap the clamp closed. No extra materials or greases are required. The PowerGel sealant is already in the cap.

### Easy to Reenter

The GelCap SL splice cover is easy to re-enter because the PowerGel sealant pulls away leaving a clean connection. Re-entry is also safer than other methods because no sharp objects or cutting tools are required for removal of the cap.

### Other Common Uses for GelCap Splice Cover Kits

- Irrigation systems
- HVAC
- Outdoor lighting
- Motor connections

### Selection Information

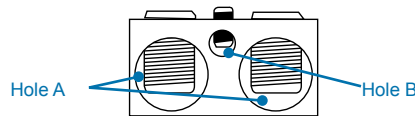

Catalog Number	Hole A		Hole B		Std. Pack
	Wire Range	Recommended Torque Values	Wire Range	Recommended Torque Values	
GelCap-SL-2/0-3 Hole	#14-2/0 AWG	120-180 in-lbs	#14-6 AWG	120-150 in-lbs	10
GelCap-SL-2/0-3 Hole-B100	#14-2/0 AWG	120-180 in-lbs	#14-6 AWG	120-150 in-lbs	100

### Product Performance

Testing	Test Conditions
Chemical Resistance	ASTM D543, Sulfuric acid, Sodium Hydroxide and motor oil
Ozone Resistance	ASTM D1149, 168 hours @ 40°C, 50 ppm
Accelerated Aging	ASTM D2671
Abrasion Resistance	2040 gm wt., 4000 cycles, 2% max thickness loss

### Ordering Information

1. Selections are based on typical dimensions of low-voltage insulated cables.
2. Kits include UL Listed connectors for use with copper and/or aluminum conductors.
3. Each kit contains a gel filled cap, cap clamp, and connector.
4. Related test reports: EDR-5334.
5. Qualified to ANSI C 119.1.



600V/105°C



C\_GHFC\_Iv

## GHFC H-Frame Closures Water Resistant Closure for Power Cable (1000 V)

TE Connectivity's Raychem low-voltage H-frame closures provide a fast, simple method for insulating and environmentally sealing low-voltage cable-taps and splices made with H-frame compression connectors.

- Utilizes TE Connectivity's PowerGel sealant material to seal and protect the connection from moisture ingress, corrosion, and pollution.
- Ideal for both underground and overhead applications and is especially useful for street lighting applications.
- Qualified to ANSI C119.1 for underground splicing.
- UV resistant.
- Qualified for temperatures from -40°C to 90°C.

Simply place the connection on the closure and press the closure together. It's that easy—no tapes, mastics, tools, or mixing are required. The closure can be easily installed with one hand.

### Selection Information: dimensions in inches (millimeters)

Catalog Number	Main	Std. Tap	Die	Conductor Size (AWG/kcmil)			Std. Pack
				Length	Width	Height	
GHFC-1-90	#6-#2	#14-#8	BG	2.75 (70)	1.625 (41)	1.0625 (27)	10 or 100
GHFC-2-90	#2-2/0	#14-#6	O	4.25 (108)	2.0 (51)	1.1875 (30)	10 or 100
GHFC-2.5-90	1/0-4/0	#6-3/0	D	7.032 (179)	2.75 (70)	1.560 (40)	30 each
GHFC-3-90	350	4/0	N	6.25 (159)	3.250 (83)	1.90 (49)	6 or 18

### Ordering Information

1. Select the appropriate catalog number. Selections are based on typical dimensions for low-voltage, insulated cables and connectors.
2. Approved connectors (supplied by others) include, but are not limited to:

Product	Approved Connectors
GHFC-1-90	Homac UB214; T&B 63105; Blackburn WR9; Burndy YPC2A8U
GHFC-2-90	Homac OB22, OB44, OB102, OB103; Burndy YHO-1, YHO-2, YHO100, YHO125, YHO150; Blackburn WR139, WR159, WR179, WR199; ILSCO AH1; T&B 63110; UTILCO HT1, HT2

3. Standard packs of 100 ea. are also available. Substitute a (B100) in place of the (B10) in the catalog number.
4. Related test report: GHFC-1-90 and GHFC-2-90,EDR-5264, GHFC-3-90,EDR-5326.

Molded cover of UV stable, impact resistant polypropylene provides rugged protection for underground or overhead applications.

Frangible fingers provide wide cable range.

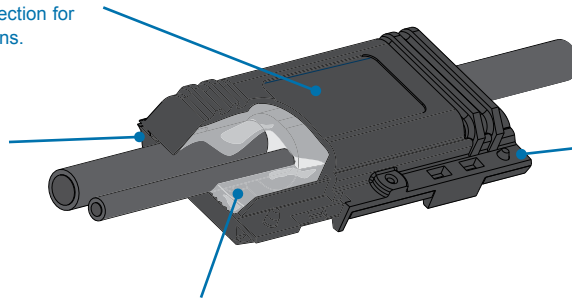

Snap-lock ensures that cover remains closed.

Silicone gel is high dielectric insulation and provides constant pressure on cable and connector to provide waterseal. PowerGel sealant is specially formulated for high temperature environments.



C\_GelPort\_Iv

## Raychem GelPort Connectors Submersible Connectors for URD Distribution (1000 V)

- Corrosion resistance
- No loose parts due to one piece housing
- Gel-filled cable entry ports provide a reliable cable seal
- PowerGel sealing gel seals out harsh environments
- Rugged, impact-resistant housing stands up to rough installations
- Clear view back allows for easy positive visual indication of wire position in connector

### Selection Information: dimensions in inches (millimeters)

#### GelPort 350/500

Catalog Number*	Number of Wire Ports	Conductor Use Range (mm <sup>2</sup> )	Length	Width	Height	Std. Pack
GPRT-350-3P	3	14-350 (2-150)	4.60 (117)	3.825 (97)	3.50 (89)	6
GPRT-350-4P	4	14-350 (2-150)	5.85 (149)	3.825 (97)	3.50 (89)	6
GPRT-350-5P	5	14-350 (2-150)	7.10 (180)	3.825 (97)	3.50 (89)	6
GPRT-350-6P	6	14-350 (2-150)	8.35 (212)	3.825 (97)	3.50 (89)	6
GPRT-350-8P	8	14-350 (2-150)	10.85 (276)	3.825 (97)	3.50 (89)	6
GPRT-350/4P-500/1P	5 Hybrid		7.10 (180)	3.825 (97)	3.50 (89)	6
	4	14-350 (2-150)				
	1	6-500 (16-250)				
GPRT-350/6P-500/2P	8 Hybrid		10.85 (276)	3.825 (97)	3.50 (89)	6
	6	14-350 (2-150)				
	2	6-500 (16-250)				

#### GelPort 500 Hybrid

Catalog Number*	Clear View	Number of Wire Ports	Max. Cable O.D.	Max. Number 500 kcmil Cables	Length	Width	Height
GPRT-500-3P	C	3	.96	1 (#6-500 kcmil)	4.6 (117)	3.825 (97)	3.50 (89)
GPRT-500-4P	C	4	.96	2 (#6-500 kcmil)	5.85 (149)	3.825 (97)	3.50 (89)
GPRT-500-5P	C	5	.96	3 (#6-500 kcmil)	7.1 (180)	3.825 (97)	3.50 (89)
GPRT-500-6P	C	6	.96	4 (#6-500 kcmil)	8.35 (212)	3.825 (97)	3.50 (89)
GPRT-500-8P	C	8	.96	6 (#6-500 kcmil)	10.85 (276)	3.825 (97)	3.50 (89)

\*For Clear view back add "C" to catalog number. Standard back view is black

### Ordering Information

1. Selection based on typical dimensions of low voltage cables.
2. Standard package is 6/box.

### Product Performance

Testing	Test Condition
Complete unit	ANSI C119.1, Report: EDR-5379, EDR-5409, EDR-5427, EDR 5463
Connector	ANSI C119.4, Report: 502-47264, 502-47302, 502-47308
Chemical Resistance	ASTM D543 to the following liquids: Sulfuric Acid, Sodium Sulfate, Sodium Chloride, Sodium Hydroxide, Ethylene Glycol
UV Resistance	ASTM G-53-95, ASTM-D-638-95

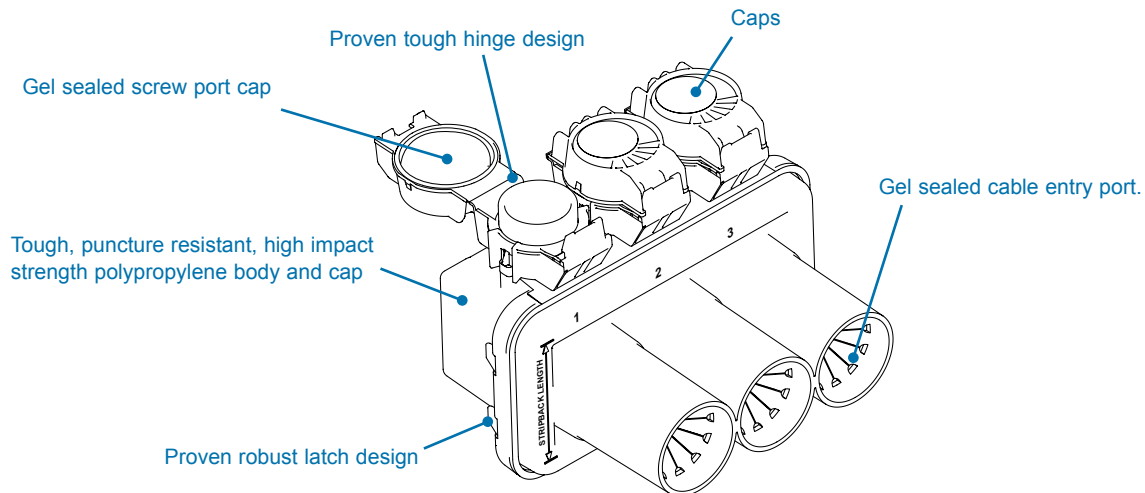



C\_SmartLimiter\_lv

## Smart Limiter Cable Protection

Smart Limiter cable protector helps support higher operating temperatures of secondary cables. Many utilities, view network systems as the most attractive option for customers seeking steadfast reliability. The Smart Limiter cable protector will assist companies in rapidly restoring their network system to its most reliable state. When the limiters operate, they can be easily identified and replaced. Available in 3-way, 5-way and 7-way configurations and is provides fast installation in compact spaces through the use of ShearBolt connectors. No special tools are No special tools are required for installation, only 11/16" socket for installation and 1/2" for removal.

- Increases reliability by protecting cable system from damage due to fault current
- Quick visual identification of blown limiters reduces the time needed to find faulted limiters
- Sealing and mechanical protection are built in, eliminating the need for additional components
- High-temperature clear inner and outer shells help in dissipating heat
- The limiter will only blow on secondary faults and effortlessly coordinate with network protector fuses
- Minimal exposure to energized parts. Only the conductor being inserted into the limiter needs to be exposed making it very safe
- Fuse operation is entirely contained in a ballistic enclosure
- 100% submersible
- GelPort cable entries will quench any arc when "live" connections are made; making picking up load safer
- Hinged bolt caps allow re-entry; enabling voltage measurements to be taken
- Modular design allows circuits to be added or subtracted without cutting cables
- Designed specifically for 208Y/120V systems

### Selection Information

Catalog Number	Description	Per Box
<b>Smart Limiter Cable Protector</b>		
SL-4/0-120V-NF-FT (B1)	Non-Fused splice for 4/0 cable	1
SL-4/0-120V-F-01 (B1)	Fused limiter for 4/0 cable	1
SL-250-120V-NF-FT (B1)	Non-Fused splice for 250 kcmil cable	1
SL-250-120V-F-01 (B1)	Fused limiter for 250 kcmil cable	1
SL-350-120V-NF-FT (B1)	Non-Fused splice for 350 kcmil cable	1
SL-350-120V-F-01 (B1)	Fused limiter for 350 kcmil cable	1
SL-500-120V-NF-FT (B1)	Non-Fused splice for 500 kcmil cable	1
SL-500-120V-F-01 (B1)	Fused limiter for 500 kcmil cable	1
SL-750-120V-NF-FT (B1)	Non-Fused splice for 750 kcmil cable	1
SL-750-120V-F-01 (B1)	Fused limiter for 750 kcmil cable	1
<b>Crab Joint</b>		
CJ-4/0-3W3W-CU-FT-B1	3 way/3 way copper crab joint with 4/0 conductors	1
CJ-4/0-5W5W-CU-FT-B1	5 way/5 way copper crab joint with 4/0 conductors	1
CJ-4/0-7W7W-CU-FT-B1	7 way/7 way copper crab joint with 4/0 conductors	1
CJ-250-3W3W-CU-FT-B1	3 way/3 way copper crab joint with 250 kcmil conductors	1
CJ-250-5W5W-CU-FT-B1	5 way/5 way copper crab joint with 250 kcmil conductors	1
CJ-250-7W7W-CU-FT-B1	7 way/7 way copper crab joint with 250 kcmil conductors	1
CJ-350-3W3W-CU-FT-B1	3 way/3 way copper crab joint with 350 kcmil conductors	1
CJ-350-5W5W-CU-FT-B1	5 way/5 way copper crab joint with 350 kcmil conductors	1
CJ-350-7W7W-CU-FT-B1	7 way/7 way copper crab joint with 350 kcmil conductors	1
CJ-500-3W3W-CU-FT-B1	3 way/3 way copper crab joint with 500 Kcmil conductors	1
CJ-500-5W5W-CU-FT-B1	5 way/5 way copper crab joint with 500 kcmil conductors	1
CJ-500-7W7W-CU-FT-B1	7 way/7 way copper crab joint with 500 kcmil conductors	1
CJ-750-3W3W-CU-FT-B1	3 way/3 way copper crab joint with 750 kcmil conductors	1
CJ-750-5W5W-CU-FT-B1	5 way/5 way copper crab joint with 750 kcmil conductors	1
CJ-750-7W7W-CU-FT-B1	7 way/7 way copper crab joint with 750 kcmil conductors	1

### Related test reports:

EDR-5445, EDR-5446, EDR-5450, EDR-5452, 502-47332, 502-47339, 502-47348.



# MEDIUM VOLTAGE CABLE ACCESSORIES

## In-Line Splice

### Heat-Shrink

HVS-500/HVSA-500 Non-Shielded (5 kV) . . . . .	124
HVS-J Jacketed Concentric Neutral Cables (15 kV) . . . . .	125
HVS-J 1/C Jacketed Concentric Neutral Cables (25-35 kV) . . . . .	126
HVS-C-RJ Repair Sleeve (15-25 kV) . . . . .	127
HVS-C-1520S 1/C Shielded (15 kV) . . . . .	128
HVS-S-1520S 1/C Shielded with ShearBolt (15 kV) . . . . .	129
HVS 1/C Shielded (5-35 kV) . . . . .	130
HVS 1/C LC Shielded & Flat Strap (15 kV) . . . . .	131
HVS 1/C LC Shielded & Flat Strap (25-35 kV) . . . . .	132
TECK Splice for TECK Cable (1000 V-15 kV) . . . . .	133
HVS-Shim Kits (5-35 kV) . . . . .	134
HVS-3 3/C Shielded (5-25 kV) . . . . .	135
HVSA-3 3/C Shielded (5-15 kV) . . . . .	136
HVS-3/C Mod Kits (5-35 kV) . . . . .	137
HVSA Mod Kits (5-35 kV) . . . . .	138
HVS/HVSR Reducer Kit (15-35 kV) . . . . .	139
HVS-3-1590S/HVS-3-2590S 3/C PIL (15-25 kV) . . . . .	140
HVS-T/HVSR-T Reducer Kits (15-35 kV) . . . . .	141
HVS-T-1590S Trifurcating Kit (15 kV) . . . . .	142
HVS/HVSA-3-1580S Transition Kit (15 kV) . . . . .	143
HVSY Wye Tap Splice (15 kV) . . . . .	144
HVSH-MOD H-Configuration Kit (15 kV) . . . . .	145
HVES Live End Seal (15-25 kV) . . . . .	146
HV-MSK Mining Cable (5-8 kV) . . . . .	147

### Cold-Applied

CSJA 1/C Shielded (15-35 kV) . . . . .	148
CSJA JCN/EG 1/C Jacketed Concentric Neutral (15-35 kV) . . . . .	150
CSJG 1/C Jacketed Concentric Neutral (15-25 kV) . . . . .	152
3/C CSJA 3/C Armored (15-35 kV) . . . . .	154
3/C CSJA 3/C TECK (15 kV) . . . . .	156

## Terminations

### Heat-Shrink

HVT-50 1/C and 3/C Non-Shielded (5 kV) . . . . .	157
HVT-Z-J/SJ Jacketed Concentric Neutral (15-35 kV) . . . . .	158
HVT-Z Built-In Stress Control (5-35 kV) . . . . .	159
MOD-3-HVT 3/C Modification Kit (5-35 kV) . . . . .	161
HVT-Z-LC/SLC LC Shielded (15-35 kV) . . . . .	163
HVT-ZL Co-Extruded One-Piece Termination . . . . .	164
HVT/HVT-3 1/C, 3/C PILC/VCLC (15 kV) . . . . .	165
HVT-M Flexible Cable (5-25 kV) . . . . .	166

### Cold-Applied

TFT-R 1/C Shielded & Non-Shielded (5-35 kV) . . . . .	167
TFT-E 1/C Shielded (15-35 kV) . . . . .	168
MOD-3-TFT Modification Kit (5-35 kV) . . . . .	170

## Motor Connection Kits & Stub Splices

GelCap 8 Motor Connection Kit (5-8 kV) . . . . .	171
MCK-5 Stub Splice (5-8.7 kV) . . . . .	172

## Elbows & Accessories

ELB-15/28 600 Series T-Body Elbow (15-28 kV) . . . . .	173
ELB-35 600 Series T-Body Elbow (35 kV) . . . . .	174
Deadbreak Stand-off Plug (28-35 kV) . . . . .	175
Deadbreak Insulating Cap (15/28 kV) . . . . .	176
Deadbreak Connecting Plug (15/28-35 kV) . . . . .	177
Deadbreak Junctions (15/28-35 kV) . . . . .	178
ELB-15/28-600 Elbow Modular System (15-35 kV) . . . . .	180
ELB-35-600 Arrester T-Body Elbow (35 kV) . . . . .	181
CES Cold Applied Elbow Seal (15-35 kV) . . . . .	182
ESA Elbow Sealing Adaptor . . . . .	183
GelWrap ES Wrap-Around Sealing Adaptor . . . . .	184
RVS-SK Roll-On Elbow Sealing Adapter . . . . .	185
JGK-MS Grounding Kits (15-35 kV) . . . . .	186
Gelwrap MS-GRD Grounding Kits . . . . .	187
HVE-1590 PILC Elbow Adapters (15 kV) . . . . .	188



C\_HVS\_HVSA\_500

## Raychem HVS-500/HVSA-500 Splices for 1/C and 3/C Inline Cable, Including Armored (5 kV Non-Shielded)

- Non-shielded cable splices provide high abrasion-resistance and a positive environmental seal
- Kits accommodate both jacketed and unjacketed cable
- Rated to meet the applicable portions of IEEE 404

### Selection Information: dimensions in inches (millimeters)

#### HVS-500

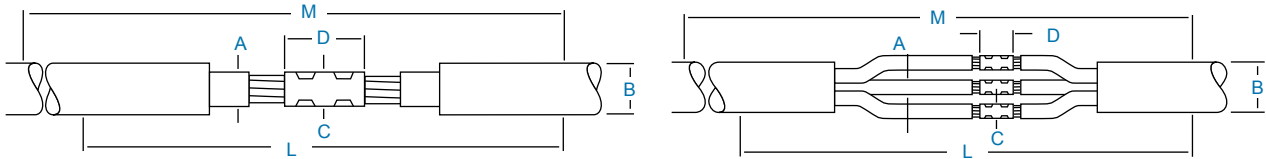

Catalog Number	Conductor Size (AWG/kcmil)	Insulation Diameter (Min.-Max.)	Jacket O.D. (Max.)	Maximum Connector Dimensions		Kit Installed Length L	Required Installation Space M
		A	B	C	D		
<b>1/C Non-Shielded Power Cable</b>							
HVS-501	#6-#1	0.40-0.70 (10-18)	0.80 (20)	0.65 (17)	3.0 (76)	10 (254)	22 (559)
HVS-502	1/0-300	0.65-1.05 (17-27)	1.20 (30)	1.00 (25)	4.0 (102)	11 (279)	24 (610)
HVS-503	350-1000	0.95-1.65 (24-42)	1.84 (47)	1.85 (47)	6.0 (152)	15 (381)	30 (762)
<b>HVS-3-500 3/C Non-Shielded Power Cable - No Armor</b>							
HVS-3-501	#6-#1	0.40-0.70 (10-18)	3.00 (76)	0.65 (17)	3.0 (76)	32 (812)	40 (1016)
HVS-3-502	1/0-300	0.65-1.05 (17-27)	3.00 (76)	1.00 (25)	4.0 (102)	40 (1016)	48 (1219)
HVS-3-503	350-1000	0.95-1.65 (24-42)	3.95 (100)	1.85 (47)	6.0 (152)	48 (1219)	56 (1422)
<b>HVSA-3-500 3/C Non-Shielded Power Cable - Armor</b>							
HVSA-3-501	#6-#1	0.40-0.70 (10-18)	3.00 (76)	0.65 (17)	3.0 (76)	40 (1016)	48 (1219)
HVSA-3-502	1/0-300	0.65-1.05 (17-27)	3.00 (76)	1.00 (25)	4.0 (102)	40 (1016)	48 (1219)
HVSA-3-503	350-1000	0.95-1.65 (24-42)	3.95 (100)	1.85 (47)	6.0 (152)	52 (1321)	60 (1524)

### Ordering Information

1. Select the appropriate catalog number. Selections are based on 100%-insulated cables, manufactured in accordance with ICEA S-66-524 standard and commonly used connectors. Nominal insulation thickness (100%): 110 mils.
2. For cables manufactured to other specifications, confirm selection with cable and connector dimensions.
3. HVS-SHIM kits are available if the diameter of one of your cables is not within the standard range.
4. Kits do not contain connectors; order compression or solder connectors separately.
5. Standard package: HVS-500: Three 1/C kits/box, HVS-3-500: One 3/C kit/box, HVSA-3-500: One 3/C kit/box
6. For an off-the-shelf 3/C splice alternative, select three appropriate 5 kV single-conductor kits from above and one HVS-3/C accessory kit (unarmored) or one HVSA accessory kit (armored cables).
7. Related test reports: EDR-5096.
8. Verify insulation diameter since 5 kV non-shielded and TECK cable diameters are NOT STANDARD.



C\_HVS\_J\_15

## HVS-J In-Line Splice for 1/C Jacketed Concentric Neutral Cables (15 kV)

These pre-engineered Raychem HVS-J splice kits provide stress control, rebuild the shielding systems, and restore primary cable insulation to 133% of the cable's original insulation level.

In addition to the unique internal moisture seal, the SJ/EJ kits feature the MBSM wraparound outer jacket which provides mechanical resistance to abrasion and impact, as well as an external moisture seal.

- High recovery forces
- Same range as prior HVS-1510S-J
- Range taking copper ShearBolt connector available

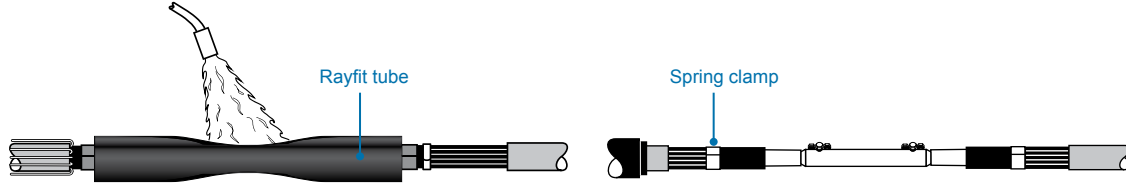

**Selection Information: dimensions in inches (millimeters)**

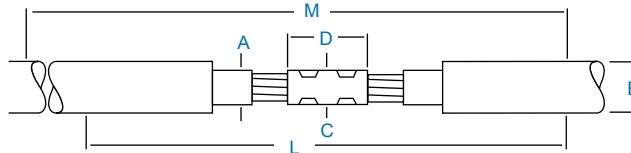

Catalog Number	Conductor Size (AWG/kcmil)	Insulation Diameter	Jacket O.D.	Maximum Connector Dimensions		Kit Installed Length	Required Installation Space
		(Min.-Max.)	(Max.)	O.D.	Length		
		A	B	C	D	L	M
<b>HVS-C-1510S-J Without Connector</b>							
HVS-C-1511S-J	#2-2/0	0.65-0.95 (17-24)	1.20 (30)	0.80 (20)	4.0 (100)	28 (700)	28 (700)
HVS-C-1512S-J	3/0-400	0.85-1.30 (23-33)	1.65 (42)	1.20 (30)	5.0 (125)	28 (700)	28 (700)
HVS-C-1513S-J	500-750	1.10-1.55 (28-47)	1.90 (48)	1.45 (44)	6.0 (150)	35 (870)	35 (870)
HVS-C-1514S-J	750-1000	1.30-1.90 (33-48)	2.30 (58)	1.85 (47)	8.0 (200)	35 (870)	35 (870)

**HVS-C-1510S-J with Copper Mechanical ShearBolt Connector**

HVS-C-1512S-J-M1	3/0-400	0.85-1.30 (23-33)	1.65 (42)	1.20 (30)	4.0 (100)	28 (700)	28 (700)
HVS-C-1513S-J-M2	500-750	1.10-1.55 (28-47)	1.90 (48)	1.45 (37)	5.0 (125)	35 (870)	35 (870)

M1 = CSBS-20C-500C-SOS, M2 = CSBS-300C-750C-SOS

**HVS-S-1510S-J-with Aluminum Mechanical ShearBolt Connector**

HVS-S-1512S-J-M4	#2-2/0	0.65-0.95 (17-24)	1.20 (30)	.095 (24)	2.5 (65)	28 (700)	28 (700)
HVS-S-1512S-J-M5	2/0-350	0.79-1.19 (20-30)	1.65 (42)	1.25 (30)	4.0 (100)	28 (700)	28 (700)
HVS-S-1513S-J-M6	350-500	1.04-1.33 (26-34)	1.80 (45)	1.30 (34)	5.0 (125)	35 (870)	35 (870)
HVS-S-1514S-J-M8	500-750	1.16-1.55 (29-39)	1.90 (48)	1.55 (40)	6.0 (150)	35 (870)	35 (870)
HVS-S-1514S-J-M9	750-1000	1.35-1.70 (34-43)	2.30 (58)	1.75 (43)	8.0 (200)	35 (870)	35 (870)

M4 = ASBS-2-3/0, M5 = ASBS-2-350, M6 = ASBS-3/0-500, M8 = ASBS-500-750, M9 = ASBS-600-1000

**Ordering Information**

1. Select the appropriate catalog number. All selections are based on the typical dimensions for both 100% and 133% insulated cables, nominal insulation thickness 0.175-0.220", 25 kV: 260 mils., 28 kV: 280 mils., 35 kV: 345 mils.
2. Use the insulation OD, and jacket OD range as the final ordering criteria.
3. Kits can be installed with either aluminum or copper compression connectors (connectors not included with kit).
4. If external grounding, contact TE Connectivity for modified installation instructions.
5. Standard package: 1 kit/box
6. Related Test Report: EDR-5440 and EDR-5444, 25 kV: EDR-5150, 28 kV: EDR-5318, 35 kV: EDR-5157 IEEE 404 and IEEE 48 draft 2006 for 105°C of Splice and Terminations.
7. For AL Mechanical ShearBolt connector information request data sheet 9-1773440-4 and for CU request 165972.

In-Line Heat-Shrink Splice



C\_HVS\_J\_25-35

**HVS-J**  
In-Line Splice for 1/C Jacketed Concentric Neutral Cables (25-35 kV)

These pre-engineered Raychem HVS-J splice kits provide stress control, rebuild the shielding systems, and restore primary cable insulation to 133% of the cable's original insulation level.

In addition to the unique internal moisture seal, the SJ/EJ kits feature the MBSM wraparound outer jacket which provides mechanical resistance to abrasion and impact, as well as an external moisture seal.

- High recovery forces
- Range taking copper ShearBolt connector available

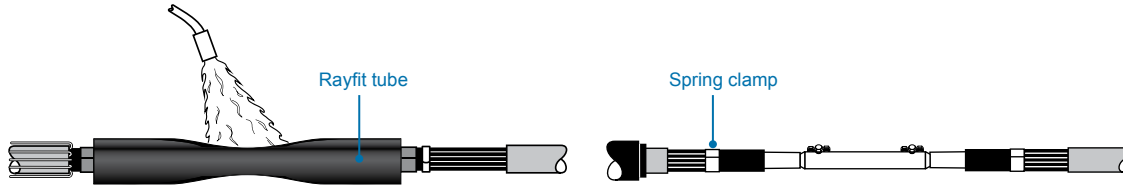

Selection Information: dimensions in inches (millimeters)

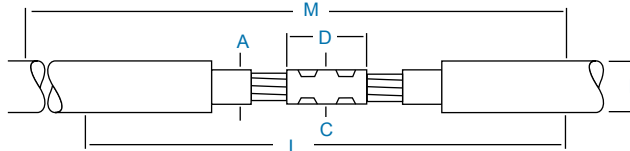

Catalog Number	Conductor Size (AWG/kcmil)	Insulation Diameter (Min.-Max.)	Jacket O.D. (Max.)	Maximum Connector Dimensions		Kit Installed Length	Required Installation Space
		A	B	O.D. C	Length D		
<b>HVS-2510E-J (25/28 kV)</b>							
HVS-2511E-J	#1-250	0.90-1.20 (23-30)	1.55 (39)	1.10 (28)	4.0 (102)	40 (1016)	56 (1422)
HVS-2512E-J	350-500	1.20-1.50 (30-38)	1.95 (50)	1.35 (34)	6.0 (152)	48 (1219)	68 (1727)
HVS-2513E-J	750-1000	1.50-1.80 (38-46)	2.40 (61)	1.85 (47)	8.0 (203)	48 (1219)	70 (1778)
<b>HVS-3510S-J (35 kV)</b>							
HVS-3511S-J	1/0-3/0	0.95-1.35 (24-34)	1.55 (39)	1.00 (25)	5.0 (127)	44 (1118)	53 (1346)
HVS-3512S-J	4/0-500	1.20-1.70 (30-43)	2.10 (53)	1.60 (41)	8.0 (203)	48 (1219)	63 (1600)
HVS-3513S-J	600-1000	1.55-2.15 (39-55)	2.80 (71)	1.85 (47)	10.0 (254)	48 (1219)	64 (1626)

Ordering Information

1. Select the appropriate catalog number. All selections are based on the typical dimensions for both 100% and 133%-insulated cables, manufactured in accordance with AEIC standard and commonly used connectors. Nominal insulation thickness (100%): 15 kV: 175 mils., 25 kV: 260 mils., 28 kV: 280 mils., 35 kV: 345 mils. Nominal insulation thickness (133%): 15 kV: 220 mils.
2. For cables manufactured to other specifications, confirm selection with cable and connector dimensions.
3. Kits do not contain connectors; order compression or solder connectors separately.
4. If external grounding and/or shield interrupting is required, order an HVS-EG kit.
5. Standard package: 1 kit/box.
6. Related test reports:  
 15 kV: EDR-5174  
 25 kV: EDR-5150  
 28 kV: EDR-5318  
 35 kV: EDR-5157





C\_HVS\_RJ

## HVS-C-RJ In-Line Heat-shrinkable Repair Splices

TE Connectivity's Raychem introduces a new 15 kV and 25 kV repair splice, for use with either Copper Tape Shield or Jacketed Concentric Neutral cables.

This series of splices utilizes the new triple-extrusion Rayfit splice sleeve which provides high recovery forces resulting in superior interfacial pressure, reduced shrink and installation time, and a slimmer space-saving profile.

- One kit replaces two conventional splices for most repairs
- Splice includes extra long tin plated aluminum shearbolt connector
- Each kit contains all of the components required for the complete joint assembly
- All HVS joints have been qualified to the latest version of IEEE-404

### Selection Information: dimensions in inches (millimeters)

Catalog Number	Conductor Size (AWG/kcmil)	Jacket O.D. (Max)	Insulation Diameter (Min-Max)	Connector Dimensions		Kit Installed Length	Required Installation Space
				Length	Diameter		
<b>For Jacketed Concentric Neutral and Unjacketed Concentric Neutral Cables (-10 Series)</b>							
<b>HVS-C-1510S-RJ-MX (15 kV)</b>							
HVS-C-1512S-RJ-M4	#2-2/0	1.20 (30)	.65-.95 (17-24)	17.3 (440)	0.95 (24)	48.0	72.0
HVS-C-1512S-RJ-M5	2/0-350	1.65 (42)	.79-1.19 (20-30)	17.3 (440)	1.29 (33)	48.0	73.0
HVS-C-1513S-RJ-M7	350-500	1.80 (45)	1.04-1.33 (26-34)	17.3 (440)	1.45 (37)	48.0	74.0
HVS-C-1514S-RJ-M8	500-750	1.90 (48)	1.16-1.55 (29-39)	17.3 (440)	1.66 (42)	48.0	76.0
HVS-C-1514S-RJ-M9	750-1000	2.30 (58)	1.35-1.70 (34-43)	17.3 (440)	1.81 (46)	48.0	76.0

M4= BSM-25/95-U-L440, M5= BSM-95/240-U-L440, M7= BSMU-120/300-L440, M8= BSM-185/400-U-L440, M9= BSMU-500-L440

### HVS-C-2510S-RJ-MX (25 kV)

HVS-C-2511S-RJ-M4	#2-3/0	1.65 (42)	.75-1.10 (19-28)	17.3 (440)	0.95 (24)	48.0	72.0
HVS-C-2512S-RJ-M5	4/0-350	2.15 (55)	1.03-1.50 (26-38)	17.3 (440)	1.29 (33)	48.0	73.0
HVS-C-2513S-RJ-M8	500-750	2.36 (60)	1.30-1.70 (34-43)	17.3 (440)	1.66 (42)	48.0	76.0
HVS-C-2514S-RJ-M9	1000	2.60 (65)	1.70-1.90 (43-49)	17.3 (440)	1.81 (46)	48.0	76.0

M4= BSM-25/95-U-L440, M5= BSM-95/240-U-L440, M8= BSM-185/400-U-L440, M9= BSMU-500-L440

### For Copper Tape Shield, Wire Shield, UniShield and Lead Sheath Cables (-20 Series)

<b>HVS-C-1520S-RJ-MX (15 kV)</b>							
HVS-C-1522S-RJ-M4	#2-2/0	1.20 (30)	.65-.95 (17-24)	17.3 (440)	0.95 (24)	40.0	69.0
HVS-C-1522S-RJ-M5	2/0-350	1.65 (42)	.79-1.19 (20-30)	17.3 (440)	1.29 (33)	40.0	69.0
HVS-C-1523S-RJ-M7	350-500	1.80 (45)	1.04-1.33 (26-34)	17.3 (440)	1.45 (37)	44.0	71.0
HVS-C-1524S-RJ-M8	500-750	1.90 (48)	1.16-1.55 (29-39)	17.3 (440)	1.66 (42)	44.0	71.0
HVS-C-1524S-RJ-M9	750-1000	2.30 (58)	1.35-1.70 (34-43)	17.3 (440)	1.81 (46)	44.0	71.0

M4= BSM-25/95-U-L440, M5= BSM-95/240-U-L440, M7= BSMU-120/300-L440, M8= BSM-185/400-U-L440, M9= BSMU-500-L440

### HVS-C-2520S-RJ-MX (25 kV)

HVS-C-2521S-RJ-M4	#2-3/0	1.65 (42)	.75-1.10 (19-28)	17.3 (440)	0.95 (24)	48.0	72.0
HVS-C-2522S-RJ-M5	4/0-350	2.15 (55)	1.03-1.50 (26-38)	17.3 (440)	1.29 (33)	48.0	73.0
HVS-C-2523S-RJ-M8	500-750	2.36 (60)	1.30-1.70 (34-43)	17.3 (440)	1.66 (42)	48.0	76.0
HVS-C-2524S-RJ-M9	1000	2.60 (65)	1.70-1.90 (43-49)	17.3 (440)	1.81 (46)	48.0	76.0

M4= BSM-25/95-U-L440, M5= BSM-95/240-U-L440, M8= BSM-185/400-U-L440, M9= BSMU-500-L440

### Ordering Information

1. Select the appropriate catalog number. All selections are based on the typical dimensions for both 100 and 133% insulated cables, nominal insulation thickness 0.175-0.220".
2. Use the insulation OD, and jacket OD range as the final ordering criteria.
3. Standard package: 1 kit/box
4. Related Test Report: EDR-5440, EDR-5444, EDR-5473, and IEEE 404 for 105°C of Splice and Terminations.
5. For AL Mechanical ShearBolt connector information request data sheet.

UniShield is a trademark of General Cable Technologies Corporation.

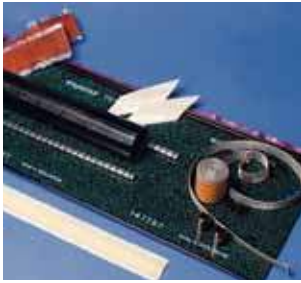

C\_HVS\_C\_1520S

## HVS-C-1520S In-Line Splice for 1/C Shielded Cable (15 kV)

TE Connectivity's Raychem heat-shrink shielded power cable splices feature a triple extrusion tube which provides increased recovery forces, reduced shrinking time and improved profile conformity.

- Reduced shrink time
- Improved heat transfer
- Significantly increased recovery forces
- Reduced overall diameters and length
- Optional copper ShearBolt connector available

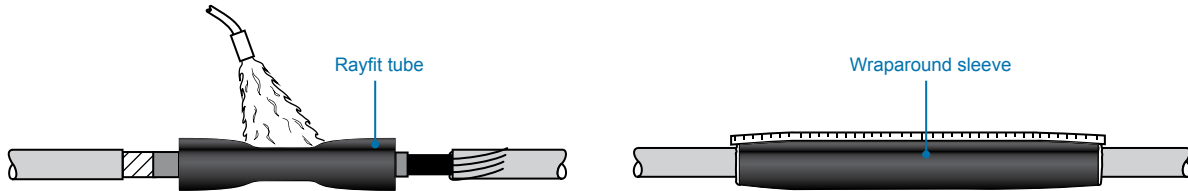

### Selection Information: dimensions in inches (millimeters)

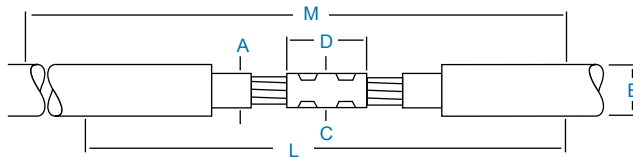

Catalog Number	Conductor Size (AWG/kcmil)	Insulation Diameter (Min.-Max.)	Jacket O.D. (Max.)	Maximum Connector Dimensions		Kit Installed Length	Required Installation Space
		A	B	C	D		
<b>HVS-C-1520S Splice for Compression Connector (not included)</b>							
HVS-C-1521S	#2-2/0	0.65-0.95 (17-24)	1.20 (30)	0.80 (20)	4.0 (100)	28 (700)	28 (700)
HVS-C-1522S	3/0-400	0.85-1.30 (23-33)	1.65 (42)	1.20 (30)	5.0 (125)	28 (700)	28 (700)
HVS-C-1523S	500-750	1.10-1.55 (28-47)	1.90 (48)	1.45 (44)	6.0 (150)	35 (870)	35 (870)
HVS-C-1524S	750-1000	1.30-1.90 (33-48)	2.30 (58)	1.85 (47)	8.0 (200)	35 (870)	35 (870)
<b>HVS-C-1520S with Copper ShearBolt (connector included)</b>							
HVS-C-1522S-M1	3/0-400	0.85-1.30 (23-33)	1.65 (30)	1.20 (30)	4.0 (100)	28 (700)	28 (700)
HVS-C-1523S-M2	500-750	1.10-1.55 (28-47)	1.90 (47)	1.45 (37)	5.0 (125)	35 (870)	35 (870)

M1= CSBS-20C-500C-SOS, M2= CSBS-300C-750C-SOS

Note: Only the above two kits are available with connectors.

### Ordering Information

1. Select the appropriate catalog number. All selections are based on the typical dimensions for both 100% and 133% insulated cables, nominal insulation thickness 0.175-0.220".
2. Use the insulation OD, and jacket OD range as the final ordering criteria.
3. Kits can be installed with either aluminum or copper compression connectors (connectors not included with kit).
4. If external grounding, order an HVS-EG kit.
5. Standard package: 1 kit/box
6. Related test reports: EDR-5440 for HVS-C and test report EDR-5444 for HVS-S, IEEE 404 and IEEE-48 for 105°C of Splice and Terminations.
7. For CU Mechanical ShearBolt connector information request data sheet 165972.

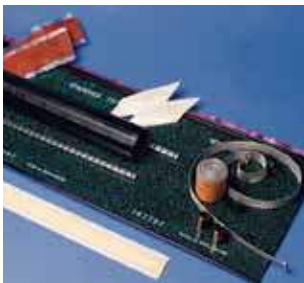

C\_HVS\_S\_1520S

## HVS-S-1520S In-Line Splice for 1/C Shielded Cables (15 kV) Includes Aluminum Mechanical ShearBolt Connector

TE Connectivity's Raychem Rayfit heat-shrink shielded power cable splice which features a triple extrusion tube. The triple extrusion tube provides increased recovery forces, reduced shrinking time and improved profile conformity.

- Reduced shrink time
- Improved heat transfer
- Significantly increased recovery forces
- Reduced overall diameters and length
- Tin plated aluminum ShearBolt Connector (CU/AL)

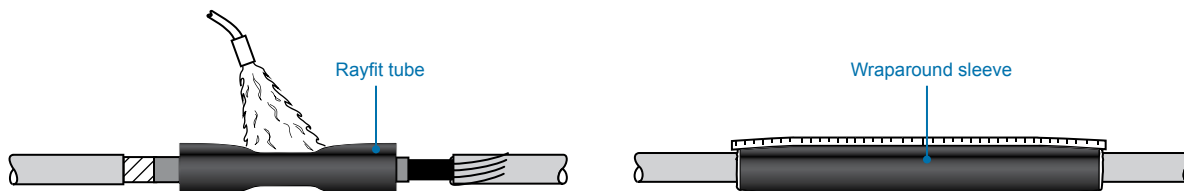

### Selection Information: dimensions in inches (millimeters)

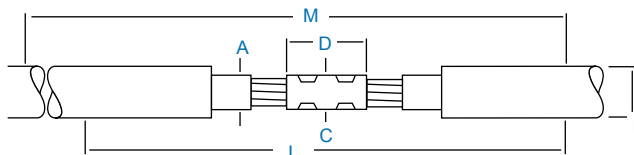

Catalog Number	Conductor Size (AWG/kcmil)	Insulation Diameter (Min.-Max.)	Jacket O.D. (Max.)	Maximum Connector Dimensions		Kit Installed Length	Required Installation Space
		A	B	C	D		
<b>HVS-S-1520S Splice for Compression Connector</b>							
HVS-S-1522S-M4	#2-2/0	0.65-0.95 (17-24)	1.20 (30)	.095 (24)	2.5 (65)	28 (700)	28 (700)
HVS-S-1522S-M5	2/0-350	0.79-1.19 (20-30)	1.65 (42)	1.25 (30)	4.0 (100)	28 (700)	28 (700)
HVS-S-1523S-M6	350-500	1.04-1.33 (26-34)	1.80 (45)	1.30 (34)	5.0 (125)	35 (870)	35 (870)
HVS-S-1524S-M8	500-750	1.16-1.55 (29-39)	1.90 (48)	1.55 (40)	6.0 (150)	35 (870)	35 (870)
HVS-S-1524S-M9	750-1000	1.35-1.70 (34-43)	2.30 (58)	1.75 (43)	8.0 (200)	35 (870)	35 (870)

M4= ASBS-2-3/0, M5= ASBS-2-350, M6= ASBS-3/0-500, M8= ASBS-500-750, M9= ASBS-600-1000

### Selection Information: dimensions in inches (millimeters)

Catalog Number	Diameter (Min.-Max.)	Insulation Moisture-Blocked Braid	Length of Braid Size (AWG)
<b>1/C cables</b>			
HVS-EG-1	0.30-1.25 (8-32)	24 (610)	#8
HVS-EG-2	1.00-2.15 (25-55)	24 (610)	#6
HVS-EG-3	1.55-3.40 (39-86)	24 (610)	#4
<b>3/C cables</b>			
HVS-EG-3-1	0.30-1.25 (8-32)	36 (914)	#8
HVS-EG-3-2	1.00-2.15 (25-55)	36 (914)	#6
HVS-EG-3-3	1.55-3.40 (39-86)	36 (914)	#4

### Ordering Information

1. Select the appropriate catalog number. All selections are based on the typical dimensions for both 100% and 133% insulated cables, nominal insulation thickness 0.175-0.220".
2. Use the insulation OD, and jacket OD range as the final ordering criteria.
3. Kits contain Tin-plated Aluminum ShearBolt connector for use with either CU or AL conductors.
4. If external grounding, order an HVS-EG kit.
5. Standard package: 1 kit/box
6. Related test reports EDR-5440 for HVS-C and test report EDR-5444 for HVS-S, IEEE 404 for 105°C.
7. For AL Mechanical ShearBolt connector information request data sheet 9-1773440-4 and for CU.



C\_HVS\_5-35

## HVS In-Line Splices for 1/C Shielded Cable (5-35 kV)

TE Connectivity's Raychem heat-shrinkable shielded power cable splices are pre-engineered to offer a compact, low-profile installation with a minimum diameter buildup.

- Kits contain a solderless grounding kit, consisting of a ground clamp, a ground braid, and a shielding mesh.
- Heat-shrink feature allows the kits to accommodate out-of-round, out-of-spec cable.

Rated to IEEE 404. For use on copper tape, wire shield, lead sheath, and UniShield cables. Some kits contain tube for outer layer.

### Selection Information: dimensions in inches (millimeters)

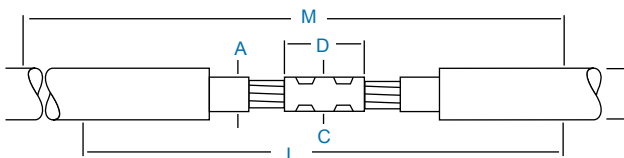

Catalog Number	Conductor Size (AWG/kcmil)	Insulation Diameter (Min.-Max.)	Jacket O.D. (Max.)	Maximum Connector Dimensions		Kit Installed Length	Required Installation Space
				O.D.	Length		
		A	B	C	D	L	M
<b>HVS-820S (5 kV) (5/8 kV)</b>							
HVS-821S	#6-2/0 #6-#2	0.35-0.65 (9-17)	0.80 (20)	0.50 (13)	3.0 (76)	24 (610)	44 (1118)
HVS-822S	3/0-300 #1-4/0	0.55-0.90 (14-23)	1.15 (29)	0.75 (19)	4.25 (108)	24 (610)	45 (1143)
HVS-823S	350-750 250-350	0.80-1.25 (20-32)	1.80 (46)	1.10 (28)	6.0 (152)	27 (686)	50 (1270)
HVS-824S	1000-1500 500-750	1.00-1.60 (25-41)	2.30 (58)	1.45 (37)	8.0 (203)	30 (762)	56 (1422)
HVS-825S	750-1000 500-750	1.30-2.25 (33-57)	2.45 (62)	1.85 (47)	8.0 (203)	30 (762)	56 (1422)
<b>HVS-1520S (15 kV)</b>							
HVS-1521S	#2-4/0	0.65-1.05 (17-27)	1.25 (32)	0.90 (23)	4.25 (108)	27 (686)	54 (1372)
HVS-1522S	250-350	0.90-1.30 (23-33)	1.50 (38)	1.20 (30)	5.5 (140)	28 (711)	56 (1422)
HVS-1523S	500-750	1.10-1.60 (28-41)	1.85 (47)	1.60 (41)	8.0 (203)	30 (762)	59 (1499)
HVS-1524S	750-1000	1.25-1.80 (32-46)	2.10 (53)	1.85 (47)	8.0 (203)	34 (864)	67 (1702)
HVS-1525S	1250-2000	1.60-2.50 (41-64)	2.80 (71)	2.40 (61)	8.0 (203)	40 (1016)	74 (1880)
<b>HVS-1520S-W (15 kV with Wraparound Rejacketing Sleeve)</b>							
HVS-1521S-W	#2-4/0	0.65-1.05 (17-27)	1.25 (32)	0.90 (23)	4.25 (108)	28 (711)	39 (990)
HVS-1522S-W	250-350	0.90-1.30 (23-33)	1.50 (38)	1.20 (30)	5.50 (140)	28 (711)	40 (1016)
HVS-1523S-W	500-750	1.10-1.60 (28-41)	1.85 (47)	1.60 (41)	8.00 (203)	30 (762)	45 (1143)
HVS-1524S-W	750-1000	1.25-1.80 (32-46)	2.10 (53)	1.85 (47)	8.00 (203)	34 (864)	49 (1244)
HVS-1525S-W	1250-2000	1.60-2.50 (41-64)	2.80 (71)	2.40 (61)	11.00 (279)	40 (1016)	54 (1371)
<b>HVS-2520S (25 kV)</b>							
HVS-2521S	#1-250	0.90-1.20 (23-31)	1.50 (38)	1.10 (28)	4.0 (102)	40 (1016)	56 (1422)
HVS-2522S	350-500	1.20-1.50 (31-38)	1.95 (50)	1.35 (34)	6.0 (152)	40 (1016)	60 (1524)
HVS-2523S	750-1000	1.50-1.80 (38-46)	2.40 (61)	1.85 (47)	8.0 (203)	40 (1016)	62 (1575)
<b>HVS-3520S (35 kV)</b>							
HVS-3521S	1/0-3/0	0.95-1.35 (24-34)	1.55 (39)	1.20 (30)	4.0 (102)	40 (1016)	53 (1346)
HVS-3522S	4/0-600	1.20-1.70 (31-43)	2.10 (53)	1.50 (38)	6.0 (152)	44 (1118)	62 (1575)
HVS-3523S	600-1000	1.55-2.15 (39-55)	2.80 (71)	1.85 (47)	10.0 (254)	44 (1118)	67 (1702)

### Ordering Information

- Select the appropriate catalog number. All selections are based on the typical dimensions of 100% insulated cables, manufactured in accordance with AEIC standard. Nominal insulation thickness (100%): 5 kV: 90 mils., 5/8 kV: 115 mils., 15 kV: 175 mils., 25 kV: 260 mils., 35 kV: 345 mils. Nominal insulation thickness (133%): 15 kV: 220 mils. Check the jacket O.D. on the 15 kV, 133%-insulated 4/0 and 750-kcmil cables to ensure they fall within the use range specified. If you have any questions, contact your TE Connectivity sales engineer or representative.
- For cables manufactured to other specifications, confirm selection with cable and connector dimensions.
- HVS-SHM kits are available if the diameter of one of your cables is not within the standard range.
- Kits do not contain connectors; order compression or solder connectors separately.
- If external grounding is required, order an HVS-EG kit.
- Standard package: 1 kit/box
- Related test reports:  
 HVS 5-8 kV: EDR-5181  
 HVS 15 kV: EDR-5114  
 HVS 25 kV: EDR-5150  
 HVS 25-35 kV: EDR-5197  
 HVS-1520S-W: EDR-5225



C\_HVS\_15

## HVS 1/2 LC Shielded and Flat Strap Cables (15 kV)

TE Connectivity's Raychem Rayfit HVS kits feature a metal laminated wraparound re-jacketing sleeve that reduces moisture-vapor transmission. This tough sleeve also protects the splice from coincidental abrasion, back fill and handling damage.

Ground connections are made using heavy duty stainless steel spring clamps and tinned copper braid. The ground connections have been tested to multiple reclosed faults in excess of 13-kA rms without damage.

- Designed to withstand fault current duty of 10-kA rms for 100 cycles
- Rated to IEEE 404
- For use on LC shield cable

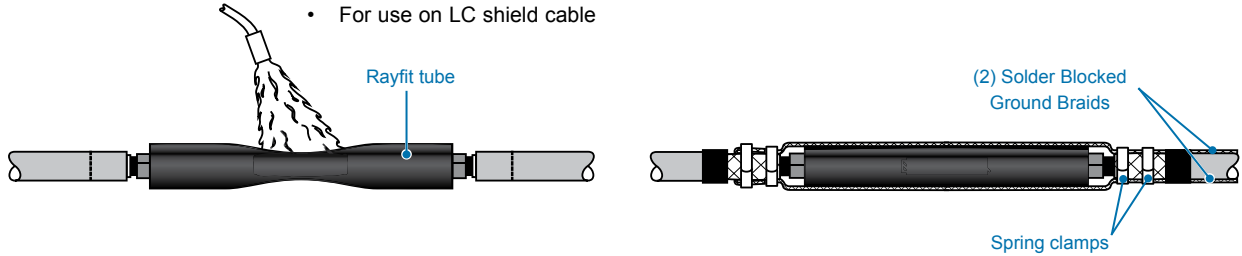

### Selection Information: dimensions in inches (millimeters)

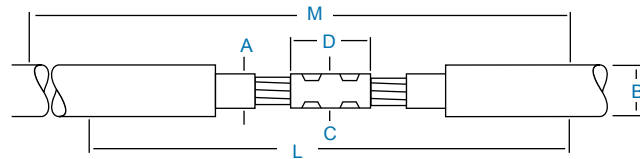

Catalog Number	Conductor Size (AWG/kcmil)	Insulation Diameter (Min.-Max.)	Jacket O.D. (Max.)	Maximum Connector Dimensions		Kit Installed Length	Required Installation Space
				O.D.	Length		
		A	B	C	D	L	M
<b>HVS-C-1530S without Connector</b>							
HVS-C-1531S	#2-2/0	0.65-0.95 (17-24)	1.20 (30)	0.80 (20)	4.0 (100)	28 (700)	28 (700)
HVS-C-1532S	3/0-400	0.85-1.30 (23-33)	1.65 (42)	1.20 (30)	5.0 (125)	28 (700)	28 (700)
HVS-C-1533S	500-750	1.10-1.55 (28-47)	1.90 (48)	1.45 (44)	6.0 (150)	35 (870)	35 (870)
HVS-C-1534S	750-1000	1.30-1.90 (33-48)	2.30 (58)	1.85 (47)	8.0 (200)	35 (870)	35 (870)

### HVS-C-1530S with Copper Mechanical ShearBolt Connector

HVS-C-1532S-M1	3/0-400	0.85-1.30 (23-33)	1.20 (30)	1.20 (30)	4.0 (100)	28 (700)	28 (700)
HVS-C-1533S-M2	500-750	1.10-1.55 (28-47)	1.45 (47)	1.45 (37)	5.0 (125)	35 (870)	35 (870)

M1 = CSBS-20C-500C-SOS, M2 = CSBS-300C-750C-SOS

### HVS-S-1530S with Aluminum Mechanical ShearBolt Connector

HVS-S-1532S-M4	#2-2/0	0.65-0.95 (17-24)	1.20 (30)	0.95 (24)	2.5 (65)	28 (700)	28 (700)
HVS-S-1532S-M5	2/0-350	0.79-1.19 (20-30)	1.65 (42)	1.25 (30)	4.0 (100)	28 (700)	28 (700)
HVS-S-1533S-M6	350-500	1.04-1.33 (26-34)	1.80 (45)	1.30 (34)	5.0 (125)	35 (870)	35 (870)
HVS-S-1534S-M8	500-750	1.16-1.55 (29-39)	1.90 (48)	1.55 (40)	6.0 (150)	35 (870)	35 (870)
HVS-S-1534S-M9	750-1000	1.35-1.70 (34-43)	2.30 (58)	1.75 (43)	8.0 (200)	35 (870)	35 (870)

M4 = ASBS-2-3/0, M5 = ASBS-2-350, M6 = ASBS-3/0-500, M8 = ASBS-500-750, M9 = ASBS-600-1000

### Ordering Information

1. Select the appropriate catalog number. All selections are based on the typical dimensions for both 100% and 133% insulated cables, nominal insulation thickness 0.175-0.220 inch.
2. Use the insulation OD, and jacket OD range as the final ordering criteria.
3. Kits can be installed with either aluminum or copper compression connectors (connectors not included with kit).
4. Kits are supplied with solder blocked ground braids.
5. Standard package: 1 kit/box
6. Related Test Report: EDR-5440 and EDR-5444, IEEE 404-2006 and IEEE 48 draft 2006 for 105°C of Splice and Terminations.
7. For AL Mechanical ShearBolt connector information request data sheet 9-1773440-4 and for CU request 165972.

In-Line Heat-Shrink Splice



C\_HVS\_25/35

## HVS Splice Kits for 1/C LC and Flat Strap Shield Cable (25-35 kV)

The Raychem HVS kits feature a metal laminated wraparound re-jacketing sleeve that reduces moisture-vapor transmission. This tough sleeve also protects the splice from coincidental abrasion, back fill, and handling damage.

Ground connections are made using stainless steel clamps and tinned copper braid. The ground connections have been tested to multiple reclosed faults in excess of 13-kA rms without damage.

- Designed to withstand fault current duty of 10-kA rms for 10 cycles
- Rated to IEEE 404

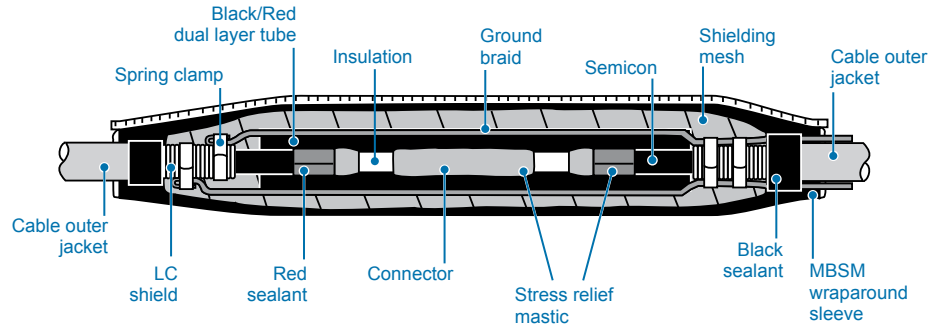

**Selection Information: dimensions in inches (millimeters)**

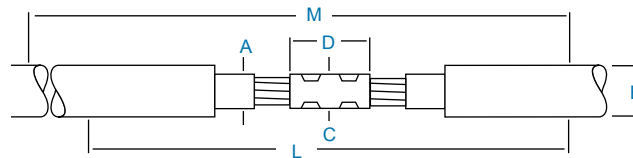

Catalog Number	Conductor Size (AWG/kcmil)	Insulation Diameter (Min.-Max.)	Jacket O.D. (Max.)	Maximum Connector Dimensions		Kit Installed Length	Required Installation Space
		A	B	C	D		
<b>HVS-2530-LC (25 kV)</b>							
HVS-2531-LC	#1-250	0.90-1.20 (16-24)	1.55 (39)	1.10 (28)	4.0 (102)	36 (914)	48 (1219)
HVS-2532-LC	350-500	1.20-1.50 (30-38)	1.95 (50)	1.35 (34)	6.0 (152)	37 (940)	50 (1270)
HVS-2533-LC	750-1000	1.50-1.80 (38-46)	2.40 (61)	1.85 (47)	8.0 (203)	39 (991)	54 (1372)
<b>HVS-3530-LC (35 kV)</b>							
HVS-3531-LC	1/0-3/0	0.95-1.35 (29-34)	1.55 (39)	1.00 (25)	4.0 (102)	40 (1016)	52 (1321)
HVS-3532-LC	4/0-500	1.30-1.70 (33-43)	2.10 (53)	1.60 (41)	5.5 (140)	40 (1016)	58 (1473)
HVS-3533-LC	750-1000	1.65-2.15 (42-55)	2.80 (71)	1.85 (47)	8.0 (203)	48 (1219)	64 (1626)

**Ordering Information**

1. Select the appropriate catalog number. All selections are based on the typical dimensions of 100% and 133% insulated cables, manufactured in accordance with AEIC standard and commonly used connectors. Nominal insulation thickness (100%): 15 kV: 175 mils. 25 kV: 260 mils. 35 kV: 345 mils. Nominal insulation thickness (133%): 15 kV: 220 mils.
2. For cables manufactured to other specifications, confirm selection with cable and connector dimensions.
3. Kits do not contain connectors; order compression or solder connectors separately.
4. HVS kits are supplied with two pieces of braid to provide fault current carrying capacity over the splice. User should verify compatibility of supplied braids to application on LC shield cable.
5. Standard package: 1 kit/box
6. Related test reports:  
25 kV: EDR-5150  
35 kV: EDR-5157



C\_TECK

## TECK Splices for TECK Cable (1000 V-15 kV)

Designed specifically for TECK power cable, the Raychem TECK splice kits are easy to install and are ideal for underground and cable tray applications. The splice is protected from moisture and mechanical damage by two layers of adhesive-lined WCSM heavy-wall tubing and one layer of CRSM wraparound sleeve.

- Positive environmental sealing
- Complete grounding and bonding
- Fast, easy installation
- Slim profile

CSA certified to C22.2, No. 198.2. For use on 1/C and 4/C 1000-V TECK cable and 3/C 5 kV TECK cable.

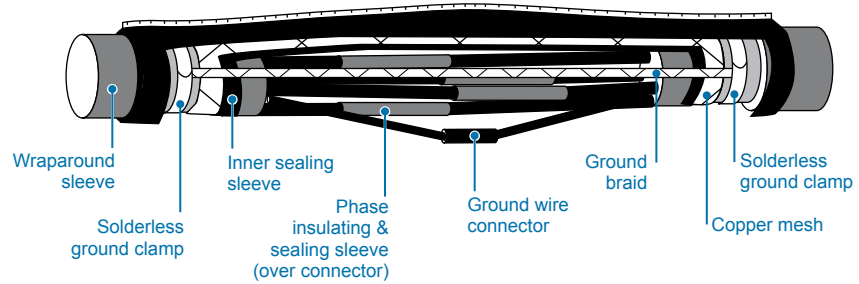

**Selection Information: dimensions in inches (millimeters)**

Catalog Number	Nominal Cable Range	Insulation Diameter (Min.-Max.)	Inner Jacket Diameter Range	Outer Jacket Diameter Range	Maximum Connector Length	Splice Installed Length
<b>Low-Voltage 1/C</b>						
TECK-10	#6-#1 AWG	0.30-0.50 (10-15)	0.40-0.80 (10-20)	0.70-1.10 (20-30)	2.0 (50)	22 (560)
TECK-11	1/0-3/0 AWG	0.45-0.70 (10-20)	0.65-0.90 (15-25)	1.00-1.15 (25-30)	3.5 (90)	22 (560)
TECK-12	4/0-350 MCM	0.60-0.90 (15-25)	0.80-1.10 (20-30)	1.10-1.45 (30-35)	5.0 (125)	25 (635)
TECK-13	400-750MCM	0.80-1.20 (20-30)	1.10-1.50 (30-40)	1.40-1.80 (35-45)	7.5 (190)	29 (735)
TECK-14	1000-2000 MCM	1.20-2.10 (30-55)	1.50-20.40 (40-60)	1.90-2.80 (50-70)	8.0 (205)	40 (1015)
<b>Low-Voltage 4/C</b>						
TECK-41	#14-#4		0.50-1.20 (15-30)	0.70-1.45 (20-35)	2.0 (50)	25 (650)
TECK-42	#2-3/0		1.00-1.70 (25-45)	1.30-2.10 (35-55)	3.0 (75)	25 (650)
TECK-43	4/0-400		1.50-2.50 (40-65)	2.00-3.00 (50-70)	4.0 (100)	40 (1015)
TECK-44	500-1000		2.00-3.50 (50-90)	2.50-4.00 (65-100)	6.5 (165)	40 (1015)
<b>5 kV Unshielded 3/C</b>						
TECK-531	#2-4/0	0.40-0.75 (10-20)	1.20-2.00 (30-50)	1.50-2.40 (40-60)	3.5 (90)	40 (1015)
TECK-532	250-750	0.65-1.20 (15-30)	1.80-3.00 (45-75)	2.20-3.25 (55-85)	6.0 (150)	48 (1220)
<b>15 kV Shielded 3/C</b>						
HVSA-3-1521S-TECK	#2-4/0AWG	0.65-1/05 (17-27)	1.75-4.5 (45-115)	2.50-6.5 (65-165)	4.25 (105)	72 (1830)
HVSA-3-1522S-TECK	250-350 kcmil	0.90-1.30 (23-33)	2.50-6.0 (65-150)	2.50-6.5 (65-165)	5.5 (140)	80 (2030)
HVSA-3-1523S-TECK	500-750 kcmil	1.10-1.60 (28-41)	2.50-6.0 (65-150)	2.50-6.5 (65-165)	8.0 (200)	80 (2030)
HVSA-3-1524S-TECK	750-1000 kcmil	1.25-1.80 (32-46)	2.50-6.0 (65-150)	2.50-6.5 (65-165)	8.0 (200)	80 (2030)

**Ordering information**

1. Select the appropriate catalog number based on cable size. Confirm selection with dimensions to assure proper sizing.
2. Kits do not contain connectors or lugs; you must order them separately. Installed connector or lug diameter must be within use range.
3. CSA certification applies only to applications up to 1000 volts.
4. Standard package: 1 kit/box
5. Related test report: 1000 volts: EDR-5194





C\_HVS\_SHIM

## HVS-SHIM Heat-Shrinkable Shim Kits (5-35 kV)

Use TE Connectivity's Raychem HVS shim kits to increase the insulation diameter of a polymeric cable, allowing it to fit in the use range of a standard splice kit. For use on copper tape, LC shield, wire shield, lead sheath, UniShield, and jacketed/unjacketed concentric neutral cables.

### Follow these steps to select the appropriate shim kit:

1. Verify that the insulation diameters of the two cables to be spliced do not fall within the insulation range of any standard splice kit.
2. Select the splice kit that fits the larger of the two cables within the kit's insulation-diameter use range. If the larger cable fits in more than one kit, choose the smaller kit.
3. Determine the minimum cable insulation diameter for the kit and find that value in the first column below. Example: An HVS-1523S kit has a cable insulation range of 1.10-1.60 inches. Therefore, the minimum cable insulation diameter for this kit is 1.10 inches.
4. In the second column, find the insulation diameter range in which the smaller cable falls.  
*Note: If the smaller cable does not fit within any of the specified ranges in the second column, a standard shim cannot be used for your application. Contact your local TE Connectivity representative for more information.*
5. In the third column, find the correct HVS-SHIM kit to order.

### Selection Information: dimensions in inches (millimeters)

Find the kit's minimum cable insulation diameter in this column	Find the smaller cable's insulation diameter range in this column	This is the HVS-SHIM kit to order
0.80 (20)	0.60-0.80 (15-20)	HVS-SHIM-1
0.85 (22)	0.65-0.85 (17-22)	HVS-SHIM-1
0.90 (23)	0.70-0.90 (18-23)	HVS-SHIM-1
0.95 (24)	0.80-0.95 (20-24)	HVS-SHIM-1
1.00 (25)	0.85-1.00 (22-25)	HVS-SHIM-1
1.05 (27)	0.90-1.05 (23-27)	HVS-SHIM-1
	0.70-0.90 (18-23)	HVS-SHIM-2
1.10 (28)	0.90-1.10 (23-28)	HVS-SHIM-3
	0.70-0.90 (18-23)	HVS-SHIM-4
1.15 (29)	0.95-1.15 (24-29)	HVS-SHIM-3
	0.80-0.95 (20-24)	HVS-SHIM-4
1.20 (30)	1.00-1.20 (25-30)	HVS-SHIM-3
	0.85-1.00 (22-25)	HVS-SHIM-4
1.25 (32)	1.10-1.25 (28-32)	HVS-SHIM-3
	0.95-1.10 (24-28)	HVS-SHIM-4
1.30 (33)	1.15-1.30 (29-33)	HVS-SHIM-3
	1.00-1.15 (25-29)	HVS-SHIM-4
1.35 (34)	1.20-1.35 (30-34)	HVS-SHIM-3
	1.00-1.20 (25-30)	HVS-SHIM-5
1.40 (36)	1.25-1.40 (32-36)	HVS-SHIM-3
	1.05-1.25 (27-32)	HVS-SHIM-5
1.45 (37)	1.30-1.45 (33-37)	HVS-SHIM-3
	1.15-1.30 (29-33)	HVS-SHIM-5
1.50 (38)	1.35-1.50 (34-38)	HVS-SHIM-3
	1.20-1.35 (30-34)	HVS-SHIM-5
1.55 (39)	1.35-1.55 (34-39)	HVS-SHIM-6
1.60 (41)	1.40-1.60 (36-41)	HVS-SHIM-6
1.65 (42)	1.45-1.65 (37-42)	HVS-SHIM-6
1.70 (43)	1.50-1.70 (38-43)	HVS-SHIM-6
1.75 (44)	1.55-1.75 (39-44)	HVS-SHIM-6
1.80 (46)	1.60-1.80 (41-46)	HVS-SHIM-6

### Ordering Information

1. Select the appropriate shim kit catalog number based on actual cable dimensions and TE Connectivity splice kit use range.
2. Shim kits are supplied separately. Order TE Connectivity splice kit and shim kit separately.
3. Shim kits do not contain connectors. Order a size-reducing connector separately.
4. Contact your local TE Connectivity sales engineer or representative for cable sizes not listed in the selection table.
5. Standard package: 1 kit/box



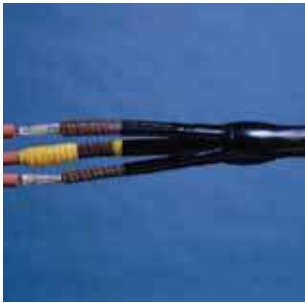

C\_HVS\_3

## HVS-3 In-Line Splices for 3/C Shielded Cable (5-25 kV)

TE Connectivity's Raychem three conductor cable splice kits are designed to rebuild all layers of the cable. These kits meet the same performance criteria as our single conductor splice kits.

- Rated to IEEE 404.
- For use on copper tape, wire shield, lead sheath, and UniShield cables.

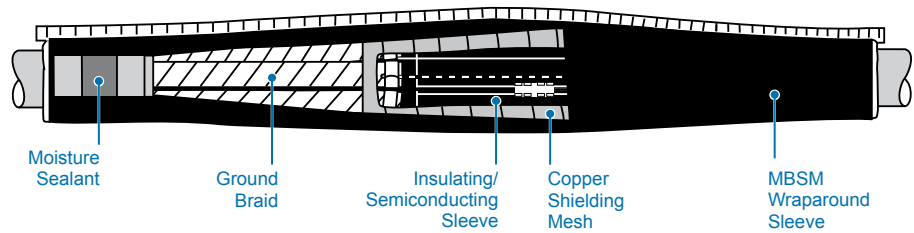

### Selection Information: dimensions in inches (millimeters)

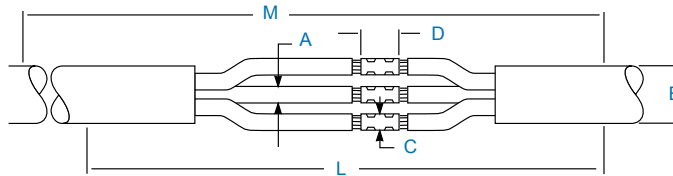

Catalog Number	Conductor Size (AWG/kcmil)		Insulation Diameter 'Min.- Max.)	Jacket O.D. (Min.)	Maximum Connector Dimensions		Kit Installed Length	Required Installation Space
	A	B	A	B	C	D	L	M
<b>HVS-3-820S (5 kV) (8 kV)</b>								
HVS-3-821S	#6-2/0*	#6-#2	0.35-0.65 (9-17)	0.90 (23)	0.50 (13)	3.0 (76)	40 (1016)	50 (1270)
HVS-3-822S	3/0-300*	#1-4/0	0.55-0.90 (14-23)	1.30 (33)	0.75 (19)	4.25 (108)	48 (1219)	58 (1473)
HVS-3-823S	350-750*	250-350	0.80-1.25 (20-32)	1.30 (33)	1.10 (28)	6.0 (152)	48 (1219)	58 (1473)
HVS-3-824S	1000-1500*	500-750	1.00-1.60 (25-41)	1.55 (39)	1.45 (37)	8.0 (203)	59 (1499)	69 (1753)
HVS-3-825S		750-1000	1.30-2.25 (33-57)	1.55 (39)	1.85 (47)	8.0 (203)	59 (1499)	69 (1753)
<b>HVS-3-1520S (15 kV)</b>								
HVS-3-1521S	#2-4/0		0.65-1.05 (17-27)	1.30 (33)	0.90 (23)	4.25 (108)	59 (1499)	69 (1753)
HVS-3-1522S	250-350		0.90-1.30 (23-33)	1.55 (39)	1.15 (29)	5.5 (140)	59 (1499)	69 (1753)
HVS-3-1523S	500-750		1.10-1.60 (28-41)	1.55 (39)	1.60 (41)	8.0 (203)	67 (1702)	77 (1956)
HVS-3-1524S	750-1000		1.25-1.80 (32-46)	2.40 (61)	1.85 (47)	8.0 (203)	67 (1702)	77 (1956)
<b>HVS-3-2520S (25 kV)</b>								
HVS-3-2521S	#1-250		0.90-1.20 (23-31)	1.65 (42)	1.10 (28)	4.0 (102)	59 (1499)	69 (1753)
HVS-3-2522S	350-500		1.20-1.50 (31-38)	1.65 (42)	1.35 (34)	6.0 (152)	67 (1702)	77 (1956)
HVS-3-2523S	750-1000		1.50-1.80 (38-46)	2.50 (64)	1.85 (47)	8.0 (203)	72 (1829)	82 (2032)

### Ordering information

- \*1. Select the appropriate catalog number. All selections are based on the typical dimensions of 100% insulated cables and commonly used connectors, manufactured in accordance with AEIC standard. Nominal insulation thickness (100%): 5 kV: 90 mils. 8 kV: 115 mils., 15 kV: 175 mils., 25 kV: 260 mils. Nominal insulation thickness (133%): 15 kV: 220 mils.
2. For cables manufactured to other specifications, confirm selection with cable and connector dimensions.
3. If using 5/8kV (115-mil) cable, use 8 kV selection.
4. For an off-the-shelf 3/C splice alternative, select three appropriate single-conductor kits and one HVS-3/C accessory kit.
5. Kits do not contain connectors; order compression or solder connectors separately.
6. If external grounding and/or shield interrupting is required, order an HVS-EG-3 kit.
7. Standard package: 1 kit/box
8. Related test reports:  
5/8 kV: EDR-5181  
15 kV: EDR-5114  
25 kV: EDR-5048  
25-35 kV: EDR-5197

In-Line Heat-Shrink Splice



C\_HVSA\_3

### HVSA-3 In-Line Splices for 3/C Armor Cable (5-15 kV)

TE Connectivity's Raychem three conductor cable splice kits are designed to rebuild all layers of the cable. These kits meet the same performance criteria as our single conductor splice kits.

- Rated to IEEE 404.
- For use on copper tape, wire shield, lead sheath, and UniShield cables.

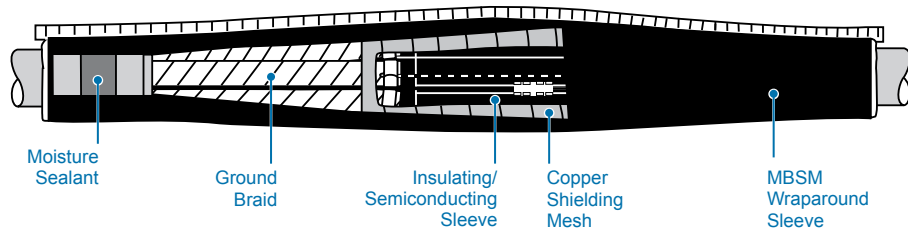

**Selection Information: dimensions in inches (millimeters)**

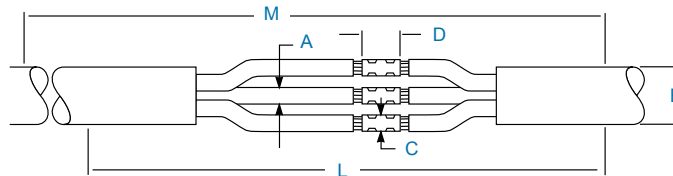

Catalog Number	Conductor Size (AWG/kcmil)*		Insulation Diameter (Min.-Max.)	Jacket O.D. (Min.)	Maximum Connector Dimensions		Kit Installed Length	Required Installation Space
	A	B	A	B	C	D	L	M
<b>HVSA-3-820S (5 kV) (8 kV)</b>								
HVSA-3-821S	#6-2/0**	#6-#2	0.35-0.65 (9-17)	0.90 (23)	0.50 (13)	3.0 (76)	48 (1219)	58 (1473)
HVSA-3-822S	3/0-300**	#1-4/0	0.55-0.90 (14-23)	1.30 (33)	0.75 (19)	4.25 (108)	48 (1219)	58 (1473)
HVSA-3-823S	350-750**	250-350	0.80-1.25 (20-30)	1.55 (39)	1.10 (28)	6.0 (152)	59 (1499)	69 (1753)
HVSA-3-824S	1000-1500**	500-750	1.00-1.60 (25-41)	1.55 (39)	1.45 (37)	8.0 (203)	63 (1600)	73 (1854)
HVSA-3-825S		750-1000	1.30-2.25 (33-57)	2.40 (61)	1.85 (47)	8.0 (203)	67 (1702)	77 (1956)
<b>HVSA-3-1520S (15 kV)</b>								
HVSA-3-1521S	#2-4/0		0.65-1.05 (17-27)	1.55 (39)	0.90 (23)	4.25 (108)	63 (1600)	73 (1854)
HVSA-3-1522S	250-350		0.90-1.30 (23-33)	2.40 (61)	1.15 (29)	5.5 (140)	72 (1829)	82 (2082)
HVSA-3-1523S	500-750		1.10-1.60 (28-41)	2.40 (61)	1.60 (41)	8.0 (203)	72 (1829)	82 (2082)
HVSA-3-1524S	750-1000		1.25-1.80 (32-46)	2.40 (61)	1.85 (47)	8.0 (203)	72 (1829)	82 (2082)

\* Note: For voltages higher than 15 kV, please consult a TE Connectivity representative.

**Ordering Information**

1. Select the appropriate catalog number. Selections are based on the typical dimensions of 100% insulated cables and commonly used connectors, manufactured in accordance with AEIC standard. Nominal insulation thickness (100%): 5 kV: 90 mils., 5/8 kV: 115 mils., 15 kV: 175 mils. 25 kV: 260 mils. Nominal insulation thickness (133%): 15 kV: 220 mils.
2. For cables manufactured to other specifications, confirm selection with cable and connector dimensions.
3. For an off-the-shelf 3/C splice alternative, select three appropriate single-conductor kits and one HVSA MOD kit.
- \*\*4. Kits do not contain connectors; order compression or solder connectors separately.
5. If external grounding and/or shield interrupting is required, order an HVS-EG-3 kit.
6. Standard package: 1 kit/box.
7. Related test reports:  
5/8 kV: EDR-5181,  
15 kV: EDR-5114,  
25 kV: EDR-5048,  
\*\*25-35 kV: EDR-5197



C\_HVS\_3C\_ModKits

## HVS-3/C Mod Kits For Rejacketing 3/C Shielded or Non-Shielded Cable (5-35 kV)

Designed for use with three 1/C splice kits, each Raychem HVS-3/C kit contains a rejacketing wraparound sleeve and sealant strips to complete your 3/C splice.

The MBSM wraparound sleeve provides environmental sealing, mechanical strength, and durability. The sealing mastic provides a secondary seal to protect against damage from water entering the splice region. Because just four sizes are able to rejacket a broad range of cable sizes from 5-25 kV, the HVS-3/C series kits allow complete inventory flexibility.

HVS-3/C kits are off-the-shelf alternatives for rejacketing 3/C extruded dielectric (XLPE- or EPR-insulated) power cables.

For use with three 1/C splice kits, each HVS-3/C kit contains all materials needed to convert three 1/C splices into one 3/C splice.

### Selection Information: dimensions in inches (millimeters)

3/C Splice Using Three of 1/C kits	Order This HVS-3/C kit	Splice Reference Dimensions		Kit Installed Length	Required Installation Space
		Conductor Size Range (AWG/kcmil)	Insulation Diameter		
HVS-501	HVS-3/C-1	#6-#1	0.40-0.70 (10-18)	40 (1016)	48 (1219)
HVS-502	HVS-3/C-2	1/0-300	0.65-1.05 (17-27)	48 (1219)	56 (1422)
HVS-503	HVS-3/C-2	350-1000	0.95-1.65 (24-42)	48 (1219)	56 (1422)
HVS-821S	(5 kV) HVS-3/C-1 (5/8 kV) HVS-3/C-1	#6-2/0 #6-2	0.35-0.65 (9-17) 0.35-0.65 (9-17)	40 (1016)	48 (1219)
HVS-822S	(5 kV) HVS-3/C-2 (5/8 kV) HVS-3/C-2	3/0-300 #1-4/0	0.55-0.90 (14-23) 0.55-0.90 (14-23)	48 (1219)	56 (1422)
HVS-823S	(5 kV) HVS-3/C-2 (5/8 kV) HVS-3/C-2	350-750 250-350	0.80-1.25 (20-32) 0.80-1.25 (20-32)	48 (1219)	56 (1422)
HVS-824S	(5 kV) HVS-3/C-3 (5/8 kV) HVS-3/C-3	1000-1500 500-750	1.00-1.60 (25-41) 1.00-1.60 (25-41)	60 (1524)	68 (1727)
HVS-825S	(5/8 kV) HVS-3/C-3	750-1000	1.30-2.25 (33-47)	60 (1524)	68 (1727)
HVS-1521S	HVS-3/C-3	#2-4/0	0.65-1.05 (17-27)	60 (1524)	68 (1727)
HVS-1522S	HVS-3/C-3	250-350	0.90-1.30 (23-33)	60 (1524)	68 (1727)
HVS-1523S	HVS-3/C-4	500-750	1.10-1.60 (28-41)	72 (1829)	80 (2032)
HVS-1524S	HVS-3/C-4	750-1000	1.25-1.80 (32-46)	72 (1829)	80 (2032)
HVS-2521S	HVS-3/C-4	#1-250	0.90-1.20 (23-31)	60 (1524)	68 (1727)
HVS-2522S	HVS-3/C-4	350-500	1.20-1.50 (31-38)	72 (1829)	80 (2032)
HVS-2523S	HVS-3/C-4	750-1000	1.50-1.80 (38-46)	72 (1829)	80 (2032)
HVS-3521S	HVS-3/C-4	1/0-3/0	0.95-1.35 (24-34)	72 (1829)	80 (2032)
HVS-3522S	HVS-3/C-4	4/0-600	1.20-1.70 (30-43)	72 (1829)	80 (2032)
HVS-3523S	HVS-3/C-4	600-1000	1.55-2.15 (39-55)	72 (1829)	80 (2032)

### Ordering Information

- Select the appropriate HVS-3/C kit based on the three 1/C kits used for the application (see table above). One HVS-3/C kit will rejacket one 3/C splice.
  - HVS-500 (5 kV) Non-shielded
  - HVS-820S (5/8 kV)
  - HVS-1520S (15 kV)
  - HVS-2520S (25 kV)
  - HVS-3520S (35 kV)
- Selections are based on the typical dimensions of 100% insulated cables and commonly used connectors, manufactured in accordance with AEIC standard. Nominal conductor size range for the 1/C splice kits is based on the typical dimensions of 100% and 133% insulated cables.
- Minimum 3/C cable jacket O.D.
 

HVS-3/C-1	0.65" (17 mm)
HVS-3/C-2	1.30" (33 mm)
HVS-3/C-3	1.80" (46 mm)
HVS-3/C-4	2.15" (55 mm)
- Standard package: 1 kit/box



C\_HVSA\_Modkits

## HVSA Mod Kits For Rearmoring and Rejacketing 3/C Armored Cable (5-35 kV)

TE's Raychem HVSA mod kits are off-the-shelf alternatives for rejacketing 3/C armored cable splices.

An alternative 3/C armored splicing system that incorporates three 1/C splices, a wraparound interlocking steel armoring case, and a wraparound sealing sleeve.

Select appropriate 1/C splice kits plus the applicable HVSA kit from the table below.

### Selection Information: dimensions in inches (millimeters)

3/C Splice Using Three of 1/C Splices	Order This HVSA Armoring Kit	Splice Reference Dimensions		Kit Installed Length	Required Installation Space
		Conductor Size Range (AWG/kcmil)	Insulation Diameter		
HVS-501	HVSA-1	#6-#1	0.40-0.70 (10-18)	48 (1219)	56 (1422)
HVS-502	HVSA-1	1/0-300	0.65-1.05 (17-27)	48 (1219)	56 (1422)
HVS-503	HVSA-2	350-1000	0.95-1.65 (24-42)	55 (1397)	63 (1600)
HVS-821S	(5 kV) HVSA-1	#6-2/0	0.35-0.65 (9-17)	48 (1219)	56 (1422)
	(5/8 kV) HVSA-1	#6-#2	0.35-0.65 (9-17)	48 (1219)	56 (1422)
HVS-822S	(5 kV) HVSA-2	3/0-300	0.55-0.90 (14-23)	55 (1397)	63 (1600)
	(5/8 kV) HVSA-2	#1-4/0	0.55-0.90 (14-23)	55 (1397)	63 (1600)
HVS-823S	(5 kV) HVSA-2	350-750	0.80-1.25 (20-32)	55 (1397)	63 (1600)
	(5/8 kV) HVSA-2	250-350	0.80-1.25 (20-32)	55 (1397)	63 (1600)
HVS-824S	(5 kV) HVSA-3	1000-1500	1.00-1.60 (25-41)	72 (1829)	80 (2032)
	(5/8 kV) HVSA-3	500-750	1.00-1.60 (25-41)	72 (1829)	80 (2032)
HVS-825S	(5/8 kV) HVSA-3	750-1000	1.30-2.25 (33-57)	72 (1829)	80 (2032)
HVS-1521S	HVSA-3	#2-4/0	0.65-1.05 (17-27)	72 (1829)	80 (2032)
HVS-1522S	HVSA-3	250-350	0.90-1.30 (23-33)	72 (1829)	80 (2032)
HVS-1523S	HVSA-3	500-750	1.10-1.60 (28-41)	72 (1829)	80 (2032)
HVS-1524S	HVSA-3	750-1000	1.25-1.80 (32-46)	72 (1829)	80 (2032)
HVS-2521S	HVSA-3	#1-250	0.90-1.20 (23-30)	72 (1829)	80 (2032)
HVS-2522S	HVSA-3	350-500	1.20-1.50 (30-38)	72 (1829)	80 (2032)
HVS-2523S	HVSA-4	750-1000	1.50-1.80 (38-46)	81 (2057)	89 (2261)
HVS-3521S	HVSA-3	1/0-3/0	0.95-1.35 (24-34)	72 (1829)	80 (2032)
HVS-3522S	HVSA-4	4/0-600	1.20-1.70 (30-43)	81 (2057)	89 (2261)
HVS-3523S	HVSA-4	600-1000	1.55-2.15 (39-55)	81 (2057)	89 (2261)

### Ordering Information

- Select the appropriate HVSA armoring kit based on the three 1/C kits used for the application (see table above). One HVSA kit will armor a 3/C splice. You will find 1/C splice kits.  
HVS-500 (5 kV Non-Shielded)  
HVS-820S (5 kV-0.90", 5/8-0.115")  
HVS-1520S (15 kV)  
HVS-2520S (25 kV)  
HVS-3520S (35 kV)
- Kits do not contain connectors.
- Nominal conductor size range for the 1/C splice kits is based on the typical dimensions of 100% and 133% insulated cables and dimensions of commonly used connectors manufactured in accordance with AEIC standard.
- Minimum 3/C cable jacket O.D.  
HVSA-1 1.30" (33 mm)  
HVSA-2 1.80" (46 mm)  
HVSA-3 2.15" (55 mm)  
HVSA-4 2.15" (55 mm)
- Standard package: 1 kit/box.



C\_HVS\_HVSR

## HVS/HVSR 1/C In-Line or Transition and Transition “Reducer” Kits (15-35 kV)

TE’s Raychem PILC splices utilize a highly effective oil-stop system. The system helps to reduce installation and outage time by eliminating insulation stepping, hand taping, lead wiping, and compound filling. Tested to the electrical and load cycling requirements of IEEE 404.

HVSR “reducer” kits are used as a transition splice when the PILC/VCLC conductor size is much smaller than that of the poly cable.

- Use as an in-line splice for paper-insulated, lead-covered (PILC) cable or varnished cambric-insulated, lead-covered (VCLC) cable
- Can also be used as a transition splice—PILC/VCLC to poly (copper tape, lead sheath, wire shield, UniShield, or jacketed/unjacketed concentric neutral) cable.

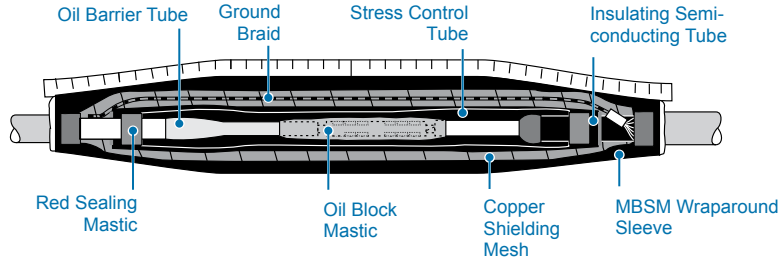

### Selection Information: dimensions in inches (millimeters)

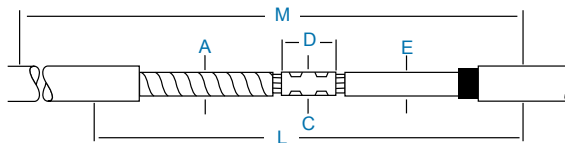

Catalog Number	PILC/poly Conductor Size (AWG/kcmil)	Insulation Diameter (Min.-Max.)		Connector Dimension (Max.)			Kit Installed Length L	Required Installation Space M
		PILC	Poly	Both Cables O.D.	PILC/PILC Length D	PILC/poly Length D		
		A	E	C	D	D		
<b>HVS-1580D (15 kV)</b>								
HVS-1581D	#4-4/0	0.60-0.90 (15-23)	0.65-1.05 (17-27)	0.90 (23)	3.5 (89)	4.5 (114)	31 (787)	48 (1219)
HVS-1582D	250-350	0.85-1.10 (22-28)	0.90-1.30 (23-33)	1.15 (29)	3.5 (89)	5.5 (140)	35 (889)	50 (1270)
HVS-1583D	500-750	1.05-1.30 (27-33)	1.10-1.60 (28-41)	1.60 (41)	5.0 (127)	7.0 (178)	37 (940)	50 (1270)
HVS-1584D	750-1000	1.15-1.50 (29-38)	1.25-1.80 (32-46)	1.85 (47)	6.0 (152)	8.0 (203)	40 (1016)	54 (1392)
<b>HVS-2580E (25 kV)</b>								
HVS-2582E	#1-250	0.85-1.20 (22-30)	0.90-1.25 (23-32)	1.10 (28)	3.5 (89)	4.5 (114)	40 (1016)	57 (1448)
HVS-2583E	350-500	1.15-1.45 (29-37)	1.15-1.50 (29-38)	1.35 (34)	5.0 (127)	8.0 (203)	40 (1016)	58 (1473)
HVS-2584E	750-1000	1.50-1.70 (38-43)	1.60-1.90 (41-48)	1.85 (47)	6.0 (152)	9.0 (229)	40 (1016)	61 (1549)
<b>HVS-3580D (35 kV)</b>								
HVS-3582D	1/0-250	1.05-1.40 (27-36)	1.05-1.40 (27-36)	1.20 (30)	3.5 (89)	5.5 (140)	40 (1016)	62 (1575)
HVS-3583D	300-750	1.20-1.70 (30-43)	1.30-1.75 (33-44)	1.60 (41)	6.0 (152)	9.0 (229)	48 (1219)	67 (1702)
HVS-3584D	750-1000	1.60-2.00 (41-51)	1.65-2.00 (41-51)	1.85 (47)	7.0 (178)	10.0 (254)	48 (1219)	67 (1702)
<b>HVSR-1580 Transition Reducer (15 kV)</b>								
HVSR-1582	#4-4/0/4/0-350	0.60-0.90 (15-23)	0.90-1.30 (23-33)	1.15 (29)		5.5 (140)	33 (838)	78 (1981)
HVSR-1583	4/0-350/500-750	0.80-1.10 (20-28)	1.10-1.60 (28-41)	1.60 (41)		7.0 (178)	37 (940)	87 (2210)
HVSR-1584	4/0-500/750-1000	0.80-1.20 (20-30)	1.25-1.80 (32-46)	1.85 (47)		8.0 (203)	40 (1016)	92 (2337)
<b>HVSR-2580E Transition Reducer (25 kV)</b>								
HVSR-2583E	#1-350/350-500	0.80-1.20 (20-30)	1.15-1.50 (29-38)	1.35 (34)		7.0 (178)	40 (1016)	58 (1473)
HVSR-2584E	500-750/750-1000	1.25-1.50 (32-38)	1.55-1.90 (39-48)	1.85 (47)		8.0 (203)	40 (1016)	61 (1549)

### Ordering Information

1. Select the appropriate catalog number. Selections are based on the typical dimensions of 100% and 133% insulated cables and commonly used connectors manufactured in accordance with AEIC standard. Nominal insulation thickness (100%): 15 kV: 165 mil (PILC/VCLC), 175 mils (poly). 25 kV: 255 mils (PILC/VCLC), 260 mils (poly). 28 kV: 255 mils (PILC/VCLC), 280 mils (poly). 35 kV: 330 mils (PILC/VCLC), 345 mils (poly) Nominal insulation thickness (133%): 15 kV: 220 mils (poly).
2. For cables manufactured to other specifications, confirm selection with cable and connector dimensions.
3. Kits do not contain ShearBolt connectors; order oil block (sweated or compression) connectors separately.
4. Cable paper cutters are available. EXRM-1004
5. For lead sheath repair, order an HVS-LR kit.
6. Standard package: 1 kit/box
7. Related test reports:  
 15 kV: EDR-5080  
 25 kV: EDR-5083  
 28 kV: EDR-5318  
 35 kV: EDR-5184

In-Line Heat-Shrink Splice



C\_HVS\_3\_1590S

**HVS-3-1590S/HVS-3-2590S**  
3/C In-line splices for PILC cable (15-25 kV)

TE Connectivity Raychem 3/C in-line PILC splices provide a highly effective and easily installed oil stop system, using standard heat-shrinkable components. The adhesive-lined conductive breakout provides an oil- and pressure-resistant seal and grounds the conductive tubing to the lead sheath. Oil barrier tubing locks the oil in the PILC cables, converting each conductor into the polymeric equivalent.

Tested to the electrical and load cycling requirements of IEEE 404. For use on paper-insulated, lead-covered (PILC) cable, or varnished cambric-insulated, lead covered (VCLC) cable.

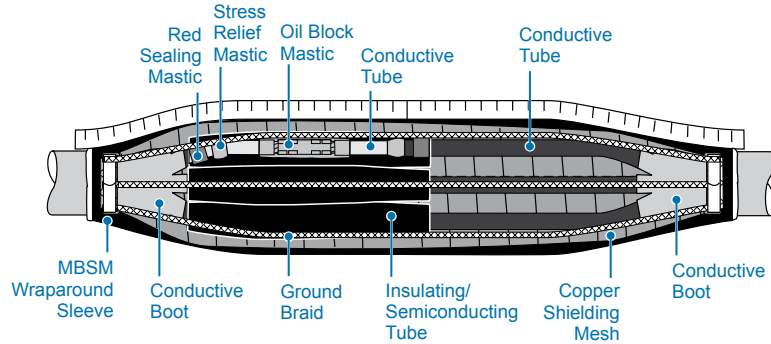

**Selection information: (dimensions in inches/millimeters)**

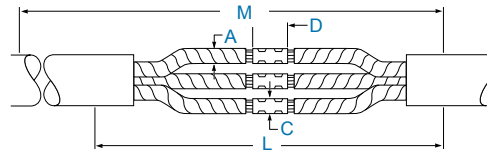

Catalog Number	PILC Conductor Size (AWG/kcmil)	PILC Insulation Dia. (min.-max.)	Connector Dimensions		Kit Installed Length L	Required Installation Space M
			Max. O.D. C	Max. Length D		
<b>HVS-3-1590 (15 kV)</b>						
HVS-3-1591	#4-4/0	0.60-1.00 (15-25)	0.90 (23)	3.5 (89)	63(1600)	67 (1702)
HVS-3-1592	250-350	0.85-1.10 (22-28)	1.15 (29)	3.5 (89)	63 (1600)	67 (1702)
HVS-3-1593	500-750	1.05-1.50 (27-38)	1.60 (41)	5.0 (127)	67 (1702)	71 (1803)
HVS-3-1594	750-1000	1.15-1.75 (29-44)	1.85 (47)	6.0 (152)	67 (1702)	71 (1803)
<b>HVS-3-1590S "shorty" (15 kV)*</b>						
HVS-3-1591S	#2-350	0.65-1.00 (17-25)	0.85 (22)	3.0 (76)	55 (1397)	55 (1397)
HVS-3-1592S	4/0-600	0.85-1.25 (22-32)	1.20 (30)	4.0 (102)	59 (1499)	59 (1499)
HVS-3-1593S	500-1000	1.00-1.50 (25-38)	1.50 (38)	5.0 (127)	59 (1499)	59 (1499)
<b>HVS-3-2590E (25 kV)</b>						
HVS-3-2591E	#1-350	0.85-1.15 (22-29)	1.15 (29)	4.0 (102)	67 (1702)	71 (1803)
HVS-3-2592E	350-750	1.10-1.50 (28-32)	1.40 (36)	5.0 (127)	67 (1702)	71 (1803)

**Ordering information**

- Select the appropriate catalog number. Selections are based on the typical dimensions of 100%-insulated cables (manufactured in accordance with the data contained in AEIC 1-1968 and commonly used connectors).  
Nominal insulation thickness (100%):  
15 kV: 165 mils., 25 kV: 255 mils.
- For cables manufactured to other specifications, confirm selection with cable and connector dimensions.
- Kits do not contain connectors; order oil block (sweated or compression) connectors separately.
- Standard package: One 3/C kit/box.
- Related test reports:  
HVS-3-1590/2590: EDR-5143  
HVS-3-1590S: EDR-5250  
HVS-3-2590E: EDR-5223
- HVS-3-1590S "shorty" splice kit does not allow cross phasing.

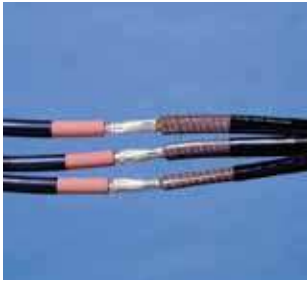

C\_HVS\_HVSR\_T

## HVS-T/HVSR-T 3/C PILC/VCLC to 1/C Poly Trifurcating Transition and Transition “Reducer” Kits (15-35 kV)

Raychem HVS-T/HVSR-T trifurcating transition splices greatly reduce the complexity of splicing one 3/C PILC cable to three 1/C polymeric cables. By converting the PILC cable to a polymeric equivalent, the splices eliminate compound filling and difficult lead wiping which lets you get on and off the job site quickly. Heat-shrink components help to eliminate lead sleeve failures by replacing lead sleeves and wipes that can crack due to corrosion or cable flexing.

HVS-T/HVSR-T series splices provide solderless ground braid connection for PILC cable. Tested to the electrical and load cycling requirements of IEEE 404. One 3/C (VCLC) cable to three 1/C poly cable. The HVSR kits are for use when the PILC/VCLC cable has a much smaller conductor size than the poly cable.

### Selection Information: dimensions in inches (millimeters)

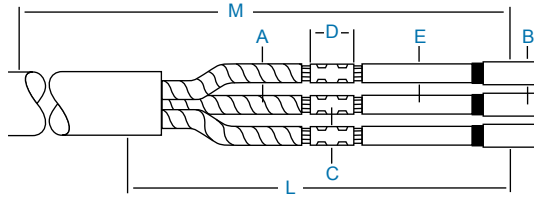

Catalog Number	PILC/Poly Conductor Size (AWG/kcmil)	Insulation Diameter (Min.-Max.)		1/C Poly Jacket O.D.	Connector Dimensions (Max.)		Kit Installed Length	Required Installation Space
		PILC A	Poly E		O.D. C	Length D		
<b>HVS-T-1580S (15 kV)</b>								
HVS-T-1581S	#4-4/0*	0.60-1.00 (15-25)	0.65-1.05 (17-27)	1.35 (34)	0.90 (23)	4.5 (114)	40 (1016)	60 (1525)
HVS-T-1582S	250-350*	0.85-1.10 (22-28)	0.90-1.30 (23-33)	1.50 (38)	1.15 (29)	5.5 (140)	40 (1016)	62 (1575)
HVS-T-1583S	500-750*	1.05-1.50 (27-38)	1.10-1.60 (28-41)	1.90 (48)	1.60 (41)	7.0 (178)	48 (1219)	68 (1727)
HVS-T-1584S	750-1000	1.30-1.75 (33-44)	1.25-1.80 (32-46)	2.15 (55)	1.85 (47)	8.0 (203)	48 (1219)	69 (1753)
<b>HVS-T-1580E-S (15 kV) Short Splice</b>								
HVS-T-1581E-S	1/0-4/0*	0.65-1.00 (17-25)	0.70-1.05 (18-27)	1.40 (36)	0.90 (23)	2.5 (63)	40 (1016)	61 (1550)
HVS-T-1582E-S	250-500*	0.85-1.20 (22-30)	0.90-1.20 (23-30)	1.50 (38)	1.35 (34)	4.5 (114)	40 (1016)	65 (1650)
HVS-T-1583E-S	500-1000	1.10-1.50 (28-38)	1.15-1.75 (29-44)	2.20 (56)	1.85 (47)	5.0 (127)	40 (1219)	69 (1753)
<b>HVS-T-2580E (25 kV)</b>								
HVS-T-2582E	#1-250	0.85-1.20 (22-30)	0.90-1.25 (23-32)	1.55 (39)	1.10 (28)	5.5 (140)	48 (1219)	65 (1650)
HVS-T-2583E	350-500	1.15-1.40 (29-36)	1.15-1.50 (29-38)	2.00 (51)	1.35 (34)	7.0 (178)	48 (1219)	75 (1900)
HVS-T-2584E	750-1000	1.50-1.70 (38-43)	1.50-1.90 (38-48)	2.15 (55)	1.85 (47)	8.0 (203)	48 (1219)	77 (1955)
<b>HVS-T-3580S (35 kV)</b>								
HVS-T-3582S	1/0-350	1.05-1.40 (27-36)	1.05-1.50 (27-38)	1.90 (48)	1.20 (30)	6.5 (165)	55 (1397)	81 (2057)
HVS-T-3583S	250-750	1.20-1.70 (30-43)	1.30-1.75 (30-44)	2.10 (53)	1.80 (46)	8.0 (203)	55 (1397)	85 (2159)
<b>HVSR-T-1580 Transition Reducer (15 kV)</b>								
HVSR-T-1582	#4-4/0/4/0-350	0.60-1.00 (15-25)	0.90-1.30 (23-33)	1.50 (38)	1.15 (29)	5.5 (140)	40 (1016)	62 (1575)
HVSR-T-1583	4/0-350/500-750	0.80-1.20 (20-30)	1.10-1.60 (28-41)	1.90 (48)	1.60 (41)	7.0 (178)	48 (1219)	68 (1727)
HVSR-T-1584	250-500/750-1000	0.85-1.30 (22-33)	1.25-1.80 (32-46)	2.15 (55)	1.85 (47)	8.0 (203)	48 (1219)	69 (1753)
<b>HVSR-T-2580E Transition Reducer (25 kV)</b>								
HVSR-T-2582E	#1-400/350-500	0.80-1.20 (20-30)	1.15-1.50(29-38)	2.00 (51)	1.35 (34)	7.0 (178)	48 (1219)	75 (1900)
HVSR-T-2583E	500-600/750-1000	1.25-1.40 (32-36)	1.55-1.90 (39-48)	2.15 (55)	1.85 (47)	8.0 (203)	48 (1219)	77 (1955)

### Ordering Information

- Select the appropriate catalog number. All selections are based on the typical dimensions of 100% and 133% insulated poly cables and commonly used connectors manufactured in accordance with AEIC standard. Nominal insulation thickness (100%): 15 kV: 165 mils (PILC/VCLC). 175 mils (poly)., 25 kV: 255 mils (PILC/VCLC). 260 mils (poly). 35 kV: 330 mils (PILC/VCLC). 345 mils (poly). Nominal insulation thickness (133%): 15 kV: 220 mils (poly).
- Check the jacket O.D. on the 133% insulated, single-conductor 15-kV 4/0, 350-kcmil, and 750-kcmil cables to ensure they fall within the use range specified. If you have any questions, contact your TE Connectivity field sales engineer or representative.
- For cables manufactured to other specifications, confirm selection with cable and connector dimensions.
- Kits do not contain connectors; order oil block (sweated or compression) connectors separately.
- Standard package: 1 kit/box
- Related test reports:  
15 kV: EDR-5137  
25 kV: EDR-5142  
35 kV: EDR-5184  
15 kV HVS-T-1580E-S: EDR-5227
- Cable paper cutters are available EXRM-1004.



C\_HVS\_T\_1590S

### HVS-T-1590S 3/C PILC/VCLC to PILC/VCLC Trifurcating Kits (15 kV)

These trifurcating Raychem splices greatly reduce the complexity of splicing one 3/C PILC cable to three 1/C PILC cables. By converting the PILC cable to a polymeric equivalent, these splices eliminate compound filling and difficult lead wiping which lets you get on and off the job site quickly.

Heat-shrink components help to eliminate lead sleeve failures by replacing lead sleeves and wipes that can crack due to corrosion or cable flexing. Tested to the electrical and load cycling requirements of IEEE 404. This kit converts one 3/C (PILC/VCLC) cable to three 1/C (PILC/VCLC) cables. For use on paper-insulated, lead-covered (PILC) cable or varnished cambric-insulated, lead-covered (VCLC) cable.

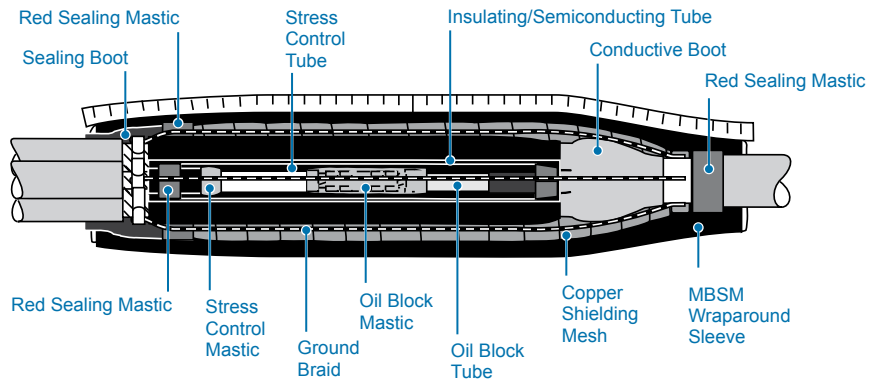

**Selection Information: dimensions in inches (millimeters)**

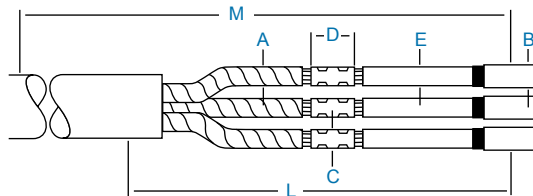

Catalog Number	PILC Conductor Size (AWG/kcmil)	PILC Insulation Dia. (Min.-Max.)	1/C PILC Jacket (Max. O.D.)	Maximum Connector O.D.	Connector Dimensions Length	Kit Installed Length	Required Installation Space
		A	B	C	D		
<b>HVS-T-1590S (15 kV)</b>							
HVS-T-1591S	#4-4/0	0.60-1.05 (15-27)	1.30 (33)	0.90 (23)	3.5 (89)	40 (1016)	60 (1524)
HVS-T-1592S	4/0-400	0.85-1.30 (22-33)	1.50 (38)	1.15 (29)	4.5 (114)	40 (1016)	60 (1524)
HVS-T-1593S	500-750	1.05-1.60 (27-40)	1.90 (48)	1.60 (41)	6.0 (152)	48 (1219)	64 (1626)

**Ordering Information**

1. Select the appropriate catalog number. All selections are based on the typical dimensions of 100% insulated cables and dimensions of commonly used connectors manufactured in accordance with AEIC standard. Nominal insulation thickness (100%): 165 mils.
2. Kits do not contain connectors; order oil block (sweated or compression) connectors separately.
3. Standard package: 1 kit/box
4. Related test reports: EDR-5143
5. Cable paper cutters are available EXRM-1004.





C\_HVSA3\_1580S

## HVS/HVSA-3-1580S 3/C PILC/VCLC to 3/C POLY (Unarmored and Armored) Kits (15 kV)

Raychem transition splices provide a reliable means for splicing 3/C 15 kV PILC/VCLC cables to 3/C 15 kV armored or unarmored polymeric cables. They eliminate the need for compound filling, lead wiping and hot oil. Installation is quick, easy, and repeatable.

TE Connectivity utilizes high temperature oil barrier tubing, oil-block mastic, and a high-density conductive boot to seal the oil within the PILC cable. This oil sealing technology has been successful in over 18 years of installations. Heat-shrink accessories fit out-of-round and sectored cables, and handle conductor size transitions. TE Connectivity utilizes its rugged MBSM re-jacketing sleeve to seal against moisture ingress. The splice also incorporates a thermoplastic internal moisture sealant as a secondary barrier. Tested to the electrical and load cycling requirements of IEEE 404. Load cycle tested to perform at a conductor temperature of 110°C with an internal oil pressure of 15 psi.

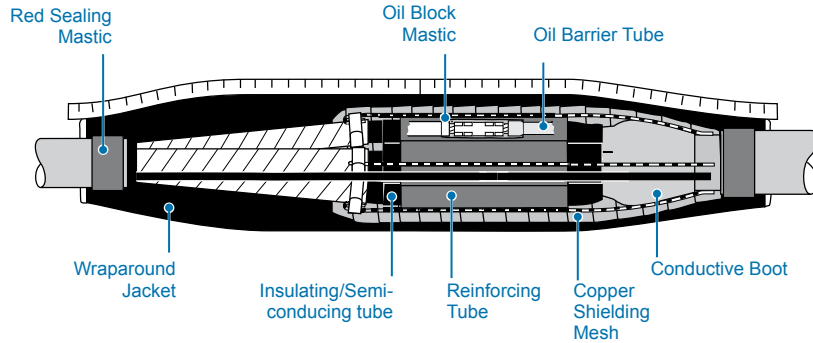

### Selection Information: dimensions in inches (millimeters)

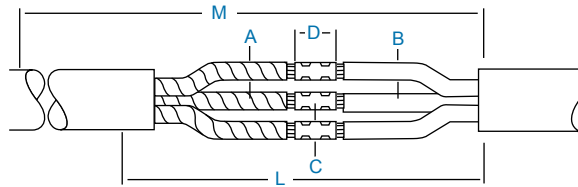

Catalog Number	PILC/Poly Conductor Size (AWG/kcmil)	Insulation Diameter (Min.-Max.)		Maximum Connector Dimensions		Kit Installed Length L	Required Installation Space M
		PILC A	Poly B	O.D. C	Length D		
<b>HVS-3-1580S Unarmored Cable (15 kV)</b>							
HVS-3-1581S	#4-4/0	0.60-1.00 (15-25)	0.60-1.05 (17-27)	1.15 (29)	5.5 (140)	60 (1524)	68 (1727)
HVS-3-1582S	250-350	0.85-1.10 (22-28)	0.90-1.30 (23-33)	1.15 (29)	5.5 (140)	60 (1524)	68 (1727)
HVS-3-1583S	500-750	1.05-1.50 (27-38)	1.10-1.60 (28-41)	1.60 (41)	7.0 (178)	72 (1829)	80 (2032)
HVS-3-1584S	750-1000	1.15-1.75 (29-44)	1.25-1.80 (32-46)	1.85 (47)	8.0 (203)	72 (1829)	80 (2032)

### HVSA-3-1580S Armored Cable (15 kV)

HVSA-3-1581S	#4-4/0	0.65-1.00 (17-25)	0.60-1.05 (17-27)	0.90 (23)	4.50 (114)	63 (1600)	70 (1778)
HVSA-3-1582S	250-350	0.85-1.10 (22-28)	0.90-1.30 (23-33)	1.15 (29)	5.5 (140)	72 (1829)	80 (2032)
HVSA-3-1583S	500-750	1.05-1.50 (27-38)	1.10-1.60 (28-41)	1.60 (41)	7.0 (178)	72 (1829)	80 (2032)
HVSA-3-1584S	750-1000	1.15-1.75 (29-44)	1.25-1.85 (32-46)	1.85 (47)	8.0 (203)	72 (1829)	80 (2032)

### Ordering Information

- Select the appropriate catalog number. All selections are based on the typical dimensions of 100% insulated cables and the dimensions of commonly used connectors manufactured in accordance with AEIC standard. Nominal insulation thickness (100%): 165 mils.
- Armored kits include an interlocking steel armoring wraparound with bendable fingers to provide a smooth transition to the armor.
- Kits do not contain connectors; order oil block (sweated or compression) connectors separately.
- Note: These kits do not allow cross-phasing.
- Standard package: 1 kit/box
- Related test reports: EDR-5137
- Cable paper cutters are available EXRM-1004.

In-Line Heat-Shrink Splice



C\_HVSY

### HVSY Wye (Tap) Splices for 1/C Poly-Poly, PILC-PILC, and PILC-Poly Cable (15 kV)

TE Connectivity's Raychem Wye (Tap) splice kits may be used for submersible or direct burial applications and have been tested to meet the performance requirements of IEEE-404. They include a positive heat-activated sealant system that eliminates taping between main and tap cables.

- Designed to seal against moisture ingress by including a branch clip and the heavy-duty MBSM wraparound sleeve
- Internal moisture seals provide a redundant seal against water intrusion
- Splices accept a wide range of main and tap cable sizes
- Compact shape simplifies cable training
- Rated to IEEE 404

HVSY-1520S is for use on copper tape, wire shield, lead sheath, and UniShield cables. HVSY-1580D is for use as a wye splice where the main and/or tap cables may be paper-insulated, lead-covered (PILC) cable; varnished cambric-insulated, or lead-covered (VCLC) cable.

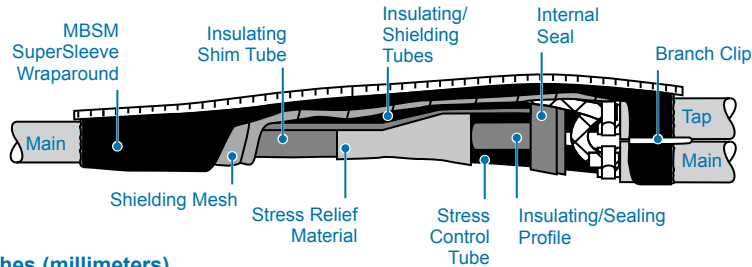

**Selection Information: dimensions in inches (millimeters)**

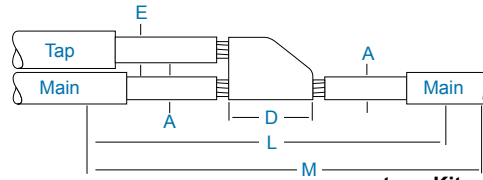

Catalog Number	Poly Conductor Size (AWG/kcmil)		Insulation Diameter (Min.-Max.)		Connector Length (Max.)	Kit Installed Length	Required Installation Space	Burdny Connector
	Main	Tap	A	E	D	L	M	

For Use with Soldered Connectors:

**HVSY-1520S (15 kV Polymeric Wye)**

HVSY-1522S	#2-4/0	#2-4/0	0.65-1.05 (17-27)	0.65-1.05 (17-27)	3.0 (75)	30 (750)	45 (1125)	
HVSY-1523S	250-750	#2-750	0.95-1.45 (24-37)	0.65-1.45 (17-37)	3.5 (90)	30 (750)	45 (1125)	

For use with Burdny YSH Crimp Connectors for Copper Conductors Only:

**HVSY-1520S (15 kV Polymeric Wye)**

HVSY-1522S	#2-4/0	#2-4/0	0.65-1.05 (17-27)	0.65-1.05 (17-27)	3.0 (75)	30 (750)	45 (1125)	YSH-2929
HVSY-1523S	250-500	4/0-500	0.85-1.25 (22-32)	0.85-1.25 (22-32)	3.5 (90)	30 (750)	45 (1125)	YSH-3434
HVSY-1523S	500-750	350-750	1.10-1.45 (28-37)	1.00-1.45 (25-37)	3.5 (90)	30 (750)	45 (1125)	YSH-3939

Catalog Number	PILC/poly Conductor Size (AWG/kcmil)		PILC/Poly Insulation Diameter (Min.-Max.)		Lead Sheath (O.D. Max.)	Connector Length (Max.)	Kit Installed Length	Required Installation Space
	Main	Tap	A	E	(O.D. Max.)	D	L	M

**HVSY-1580D (15 kV PILC and PILC-Poly Wye)**

HVSY-1582D	#2-4/0	#2-4/0	0.65-1.05 (17-27)	0.65-1.05 (17-27)	1.20 (30)	3.0 (75)	30 (750)	45 (1125)
HVSY-1583D	250-750	#2-750	0.95-1.45 (24-37)	0.65-1.45 (17-37)	1.50 (38)	3.5 (90)	30 (750)	45 (1125)

**Ordering Information**

1. Select the appropriate catalog number. All selections are based on the typical dimensions of 100% and 133% insulated cables and dimensions of commonly used connectors manufactured in accordance with AEIC standard. Nominal insulation thickness (100%): 165 mils (PILC/VCLC) 175 mils (poly) Nominal insulation thickness (133%): 220 mils (poly).
2. For cables manufactured to other specifications, confirm selection with cable and connector dimensions.
3. Kits do not contain connectors. For connector information contact your local TE Connectivity sales representative for information. For HVSY-1520S kits with copper conductors only, H-tap compressed connectors, available from Burdny (800-346-4175), may be used in place of the half-duplex connector.
4. Check poly cable insulation diameter to help ensure a proper fit.
5. For 15 kV H-configuration connections on 1/C shielded power cable, order the HVSH-1520 mod kit for use in conjunction with appropriate HVSY-1520S kit.
6. Standard package: 1 kit/box
7. Related test reports:  
HVSY-1520S: EDR-5236, EDR-5256,  
HVSY-1580D: EDR-5235.



C\_HVSH\_MOD

## HVSH-MOD H Configuration Kits for 1/C Shielded Power Cable (15 kV)

TE Connectivity's Raychem HVSH-1520D-MOD and HVSH-1580D-MOD series modification kits are used in conjunction with HVSY-1520S and HVSY-1580D-MOD series wye splice kits. This combination provides a heat-shrinkable 15 kV system that accommodates "H-configuration" connections for single-conductor power cables. This kit will accommodate both crimped connectors (copper conductor only) and soldered connectors.

These splices can be used for submersible or direct burial applications and have been tested to meet the performance requirements of IEEE 404.

### Selection Information: dimensions in inches (millimeters)

Catalog Number*	Conductor size (AWG/kcmil)		Insulation Diameter (Min.-Max.)		Connector Length (Max.)	Kit Installed Length	Required Installation Space
	Main	Tap	Main	Tap			
<b>HVSH-1520-MOD</b>							
HVSY-1522S	#2-4/0	#2-4/0	0.65-1.05 (17-27)	0.65-1.05 (17-27)	3.0 (75)	30 (750)	45 (1125)
HVSH-1522-MOD							
HVSY-1523S	250-750	#2-750	0.95-1.45 (24-37)	0.65-1.45 (17-37)	3.5 (90)	30 (750)	45 (1125)
HVSH-1523-MOD							
<b>HVSH-1580-MOD</b>							
HVSY-1582D	#2-4/0	#2-4/0	0.65-1.05 (17-27)	0.65-1.05 (17-27)	3.0 (75)	30 (750)	45 (1125)
HVSH-1582D-MOD							
HVSY-1583D	250-750	#2-750*	0.85-1.45 (22-37)	0.65-1.45 (17-37)	3.5 (90)	30 (750)	45 (1125)
HVSH-1583D-MOD							

\*Check cable insulation diameter to ensure proper fit.

### Ordering Information

- To make an "H-configuration", order both the standard HVSY kit and the HVSH-MOD kit.
- Poly cable selections are based on the typical dimensions of 100% insulated cables made in accordance with AEIC standard. Final kit selection should be verified by actual cable dimensions. PILC/VCLC cable selections are based on the typical dimensions of 100% insulated cables manufactured in accordance with AEIC standard.
- Kits do not contain connectors. For connector information contact your local TE Connectivity sales representative for information.
- Standard package: 1 kit/box
- Related test reports  
HVSH-1520-MOD: EDR-5236,  
HVSH-1580D-MOD: EDR-5235



C\_HVES

## HVES Live End Seal for 1/C PILC and Poly or 3/C PILC Cable (15-25 kV)

TE Connectivity's Raychem HVES heat-shrinkable live end seals insulate and seal the ends of polymeric and PILC cables. These kits consist of heat-shrinkable tubings and a high-dielectric strength, polymeric plug which overlap the conductor to provide excellent insulation. The outer adhesive-lined re-jacketing sleeve is designed to provide a positive environmental seal.

Once the HVES kit is installed, the cable can be re-energized. Typical applications include the live ending of spare cables for future use, isolating a failed cable length, and sectionalizing a cable circuit during system maintenance and repair, expansion, or testing.

**Selection Information: dimensions in inches (millimeters)**

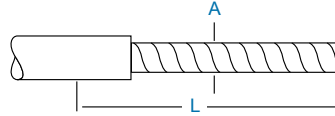

Catalog Number	PILC/Poly Conductor Size (AWG/kcmil)	Insulation Diameter (Min.-Max.)		Kit Installed Length L
		PILC A	Poly A	
<b>HVES-1520D (1/C PILC/VCLC and 1/C Poly) 15 kV</b>				
HVES-1521D	#4-4/0	0.60-0.90 (15-23)	0.65-1.05 (17-27)	12 (305)
HVES-1522D	250-350	0.85-1.10 (22-28)	0.90-1.30 (23-33)	12 (305)
HVES-1523D	500-750	1.05-1.30 (27-33)	1.10-1.60 (28-41)	12 (305)
HVES-1524D	750-1000	1.20-1.50 (30-38)	1.25-1.80 (32-46)	12 (305)

<b>HVES-2520D (1/C PILC/VCLC and 1/C Poly) 25 kV</b>				
HVES-2521D	#1-250	0.85-1.25 (22-32)	0.85-1.25 (22-32)	21 (533)
HVES-2522D	350-500	1.15-1.50 (29-38)	1.15-1.50 (29-38)	23 (584)
HVES-2523D	750-1000	1.50-1.90 (38-48)	1.50-1.90 (38-48)	25 (635)

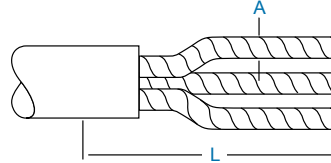

Catalog Number	PILC Conductor Size (Min.-Max.)	Insulation Diameter (Min.-Max.)		Kit Installed Length L
		PILC A	PILC A	
<b>HVES-3-1590 (3/C PILC/VCLC) 15 kV</b>				
HVES-3-1591	#4-4/0	0.60-1.00 (15-25)		27 (686)
HVES-3-1592	250-350	0.85-1.10 (22-28)		27 (686)
HVES-3-1593	500-750	1.05-1.50 (27-38)		27 (686)
HVES-3-1594	750-1000	1.15-1.75 (29-44)		27 (686)
<b>HVES-3-2590E (3/C PILC/VCLC) 25 kV</b>				
HVES-3-2591E	#1-250	0.85-1.20 (22-30)		28 (711)
HVES-3-2592E	350-500	1.15-1.40 (28-36)		31 (787)
HVES-3-2593E	750-1000	1.50-1.70 (38-43)		32 (813)

**Ordering Information**

- Select the appropriate catalog number. All selections are based on the typical dimensions of 100% insulated and 133% insulated poly cables manufactured in accordance with AEIC standard. Nominal insulation thickness (100%): 15 kV: 165 mils (PILC/VCLC). 175 mils (poly). 25 kV: 225 mils (PILC/VCLC). 260 mils (poly). Nominal insulation thickness (133%): 15 kV: 220 mils (poly).
- For cables manufactured to other specifications, confirm selection with cable dimensions.
- Standard package:  
HVES-1520D,-2520D = One kit/box  
HVES-3-1590,-2590E = One 3/C kit/box
- Related test reports:  
15 kV: EDR-5146  
25 kV: EDR-5273



C\_HVS\_MSK

## Raychem HV-MSK Splices for In-Line and Multiconductor or Medium-Voltage Multi-Conductor Mining Cable (5-8 kV)

- Flame-retardant, multiconductor splice kits for use on standard flexible cables and mining cables (MP-GC and SHD-GC) up to 8 kV
- MSHA approved for 07-LA090013-MSHA

### Selection Information: dimensions in inches (millimeters)

Catalog Number	Power Conductor Size (AWG/kcmil)				Sleeve Length
	5 kV 3/C MP-GC	5 kV 3/C SHD-GC	8 kV 3/C MP-GC	8 kV 3/C SHD-GC	
<b>HV-MSK for 3/C Flexible Cable (5-8 kV)</b>					
HV-MSK-3/C-581	#6 #1	#6 #4	#6 #4		22
HV-MSK-3/C-582	1/0-350	#2-3/0	#2-4/0	#4-2/0	22
HV-MSK-3/C-584	400-750	4/0-350	250-750	3/0-350	29

### Typical HV-MSK installation



### Ordering Information

1. Select appropriate catalog number based on conductor size for your cable type. Confirm selection with cable diameter range.
2. Kits do not contain connectors; please order separately.
3. For cable types not listed in this catalog, contact your local TE Connectivity representative.
4. Standard package: One 3/C kit per box.



C\_CSJA

## CSJA

### In-line Cold Shrinkable Joints for all 1/C Shielded Power Cables (15-35 kV)

TE Connectivity's Raychem introduces the "All-in-One" CSJA cold shrinkable joint for 15 kV through 35 kV. It is designed to splice tape shield, wire shield, LC shield, UniShield, JCN and flat strap shielded cables.

- This cable joint has a pre-expanded EPDM re-jacketing sleeve and an integrated neutral sock. The "All-in-One" design is easy to install with minimal steps and short installation time.
- A pre-expanded, single-piece silicone rubber joint body with high mechanical expansion capability allows a wide application range.
- An ergonomically designed spiral holdout provides a smooth installation with low release forces.
- Total length of the splice body on the holdout is 14 to 19 inches providing a compact design.
- The silicone rubber body provides high dielectric strength, high tear strength, low tension set, and excellent low temperature recovery.
- Integrated electrical stress control enhanced by factory molded stress cones and a Faraday cage.
- Void filling stress relief mastics are not necessary.
- Proven shield continuity concept which can also bridge concentric neutrals.
- The joint accepts both mechanical and compression connectors.
- When a ShearBolt connector is used, this is a totally crimpless system.
- Meets IEEE-404 requirements for 15 kV through 35 kV.
- Each silicone splice body is factory tested to include AC withstand and partial discharge in accordance with IEEE-404 production tests.

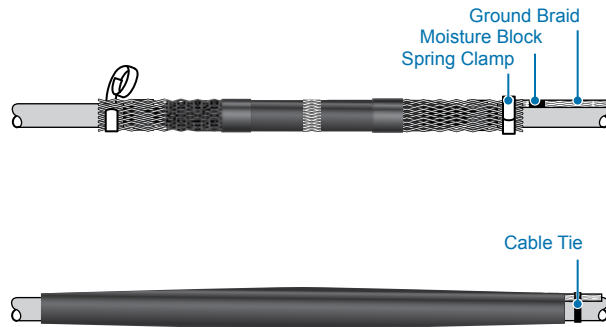

#### Ordering Information

1. Selections are based on the typical dimensions of 100% insulated cables, manufactured in accordance with AEIC standard. Nominal insulation thickness (100%): 15 kV: 175 mils, 25 kV:260 mils, 35 kV:345 mils.
2. Select the appropriate catalog number. Use the insulation OD, and jacket OD range as the final ordering criteria.
3. For mechanical ShearBolt connector included in the kit confirm the correct connector selection according to the Min/Max diameter over the cable conductor from the tables.
4. If external grounding is required, order the CSJ-EG kit.
5. For other applications or if you have any questions, contact your TE Connectivity representative.
6. Standard package: 1 kit per box.
7. Related test reports: EDR-5430, EDR-5455, EDR-5513
8. For AL Mechanical ShearBolt connector information request data sheet 9-1773440-4 and for CU request 165972.

Selection Information: Dimensions in Inches (millimeters)

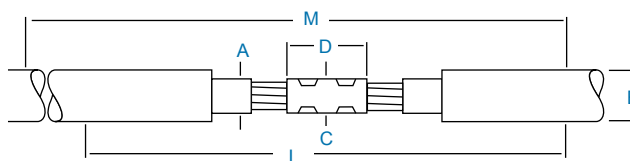

Catalog Number	Voltage Class	Nominal Cable Range	Insulation O.D. (Min.-Max.)		Jacket Sock (AWG)	Neutral Min./Max Diameter Over Cable Conductor*		Kit Installed Length L	Required Installation Space M
			A	B		C	D		

**CSJA Joint without Connector**

CSJA-1521	15 kV	#2-350	0.69-1.20 (17.5-30.5)	1.50 (38.1)	1/0	1.30 (33.0)	5.50 (140.0)	29 (737)	39 (990)
CSJA-1522	15 kV	4/0-750	0.87-1.40 (22.1-35.6)	1.80 (46.0)	1/0	1.50 (38.0)	5.50 (140.0)	29 (737)	39 (990)
CSJA-1523	15 kV	350-1000	1.03-1.58 (26.2-40.0)	2.05 (52.1)	2/0	1.65 (42.0)	6.69 (170.0)	33 (838)	43 (1090)
CSJA-1524	15 kV	750-1250	1.28-2.05 (32.50-52.0)	2.60 (66.0)	2/0	1.85 (47.0)	7.90 (200.0)	37 (939)	49 (1244)
CSJA-2822	28 kV	#1-500	0.87-1.40 (22.1-35.6)	1.80 (46.0)	1/0	1.50 (38.0)	5.50 (140.0)	29 (737)	39 (990)
CSJA-2823	28 kV	4/0-750	1.03-1.58 (26.20-40.0)	2.05 (52.1)	2/0	1.65 (42.0)	6.69 (170.0)	33 (838)	43 (1090)
CSJA-2824	28 kV	500-1250	1.28-2.05 (32.50-52.0)	2.60 (66.0)	2/0	1.85 (47.0)	7.90 (200.0)	37 (939)	49 (1244)
CSJA-3523	35 kV	1/0-350	1.03-1.49 (26.20-37.8)	2.05 (52.1)	2/0	1.40 (35.6)	5.50 (140.0)	33 (838)	43 (1090)
CSJA-3524	35 kV	350-1000	1.36-2.05 (34.54-52.0)	2.60 (66.0)	2/0	1.96 (50.0)	7.90 (200.0)	37 (939)	49 (1244)
CSJA-3525	35 kV	750-1250	1.63-2.36 (41.40-60.0)	2.60 (66.0)	2/0	2.36 (60.0)	7.90 (200.0)	37 (939)	49 (1244)

**CSJA Joint With Copper Mechanical Shear Bolt Connector**

CSJA-1521M1	15 kV	2/0-350	0.69-1.20 (17.5-30.5)	1.50 (38.1)	1/0	0.376-0.736 (9.50-18.7)		29 (737)	39 (990)
CSJA-1522M1	15 kV	4/0-500	0.87-1.40 (22.1-35.6)	1.80 (46.0)	1/0	0.376-0.736 (9.50-18.7)		29 (737)	39 (990)
CSJA-1522M2	15 kV	350-750	0.87-1.40 (22.1-35.6)	1.80 (46.0)	1/0	0.570-0.945 (14.5-24.0)		29 (737)	39 (990)
CSJA-1523M2	15 kV	350-750	1.03-1.58 (26.2-40.0)	2.05 (52.1)	2/0	0.570-0.945 (14.5-24.0)		33 (838)	43 (1090)
CSJA-2822M1	28 kV	2/0-500	0.87-1.40 (22.1-35.6)	1.80 (46.0)	1/0	0.376-0.736 (9.50-18.7)		29 (737)	39 (990)
CSJA-2823M2	28 kV	350-750	1.03-1.58 (26.2-40.0)	2.05 (52.1)	2/0	0.570-0.945 (14.5-24.0)		33 (838)	43 (1090)
CSJA-2824M2	28 kV	500-750	1.28-2.05 (32.50-52.0)	2.60 (66.0)	2/0	0.570-0.945 (14.5-24.0)		37 (939)	49 (1244)
CSJA-3523M1	35 kV	2/0-350	1.03-1.49 (26.20-37.8)	2.05 (52.1)	2/0	0.376-0.736 (9.50-18.7)		33 (838)	43 (1090)
CSJA-3524M2	35 kV	350-750	1.36-2.05 (34.54-52.0)	2.60 (66.0)	2/0	0.570-0.945 (14.5-24.0)		37 (939)	49 (1244)

\* Min./max. diameter over cable conductor accepted by the copper mechanical connector.

**CSJA Joint with Aluminum Mechanical Shear Bolt Connector**

CSJA-1521M4	15 kV	#2-3/0	0.69-1.20 (17.5-30.5)	1.50 (38.1)	1/0	0.268-0.470 (6.80-11.9)		29 (737)	39 (990)
CSJA-1521M5	15 kV	#2-350	0.69-1.20 (17.5-30.5)	1.50 (38.1)	1/0	0.268-0.681 (6.80-17.3)		29 (737)	39 (990)
CSJA-1522M6	15 kV	4/0-500	0.87-1.40 (22.1-35.6)	1.80 (46.0)	1/0	0.423-0.813 (10.7-20.6)		29 (737)	39 (990)
CSJA-1522M7	15 kV	500-750	0.87-1.40 (22.1-35.6)	1.80 (46.0)	1/0	0.736-0.998 (18.7-25.3)		29 (737)	39 (990)
CSJA-1523M8	15 kV	350-750	1.03-1.58 (26.20-40.0)	2.05 (52.1)	2/0	0.616-0.998 (15.7-25.3)		33 (838)	43 (1090)
CSJA-1524M9	15 kV	750-1000	1.28-2.05 (32.50-52.0)	2.60 (66.0)	2/0	0.813-1.152 (20.6-29.2)		37 (939)	49 (1244)
CSJA-2822M5	28 kV	#1-350	0.87-1.40 (22.1-35.6)	1.80 (46.0)	1/0	0.268-0.681 (6.80-17.3)		29 (737)	39 (990)
CSJA-2822M6	28 kV	4/0-500	0.87-1.40 (22.1-35.6)	1.80 (46.0)	1/0	0.423-0.813 (10.7-20.6)		29 (737)	39 (990)
CSJA-2823M8	28 kV	350-750	1.03-1.58 (26.20-40.0)	2.05 (52.1)	2/0	0.616-0.998 (15.7-25.3)		33 (838)	43 (1090)
CSJA-2824M8	28 kV	500-750	1.28-2.05 (32.50-52.0)	2.60 (66.0)	2/0	0.616-0.998 (15.7-25.3)		37 (939)	49 (1244)
CSJA-2824M9	28 kV	750-1000	1.28-2.05 (32.50-52.0)	2.60 (66.0)	2/0	0.813-1.152 (20.60-29.2)		37 (939)	49 (1244)
CSJA-3523M5	35 kV	1/0-350	1.03-1.49 (26.20-37.8)	2.05 (52.1)	2/0	0.268-0.681 (6.8-17.3)		33 (838)	43 (1090)
CSJA-3524M8	35 kV	350-750	1.36-2.05 (34.54-52.0)	2.60 (66.0)	2/0	0.616-0.998 (15.7-25.3)		37 (939)	49 (1244)
CSJA-3524M9	35 kV	750-1000	1.36-2.05 (34.54-52.0)	2.60 (66.0)	2/0	0.813-1.152 (20.60-29.2)		37 (939)	49 (1244)
CSJA-3525M10	35 kV	1000-1250	1.63-2.36 (41.40-60.0)	2.60 (66.0)	2/0	1.060-1.251 (23.0-31.7)		37 (939)	49 (1244)

\* Min/max diameter over cable conductor accepted by the aluminum mechanical connector.

**Cold-Applied External Grounding Kit**

Catalog Number	Length of Moisture Blocked Braid	Braid (AWG)
CSJ-EG-1	24 (610)	#8
CSJ-EG-2	24 (610)	#6
CSJ-EG-3	24 (610)	#4



C\_CSJA\_JCNEG

## CSJA JCN/EG

### In-line Cold Shrinkable Joints Specifically for 1/C Jacketed Concentric Neutral Cables (15-35 kV)

TE's Raychem "All-in-One" CSJA is a cold shrinkable joint for 15 kV through 35 kV. It is designed to splice jacketed concentric neutral (JCN) cables.

- Cable joint has a pre-expanded EPDM re-jacketing sleeve and an integrated neutral sock. The "All-in-One" design is easy to install with minimal steps and short installation time.
- A pre-expanded, single-piece silicone rubber joint body with high mechanical expansion capability allows a wide application range.
- An ergonomically designed spiral holdout provides a smooth installation with low release forces.
- Total length of the splice body on the holdout is 14 to 19 inches providing a compact design.
- The Silicone rubber body provides high dielectric strength, high tear strength, low tension set, and excellent low temperature recovery.
- Integrated electrical stress control enhanced by factory molded stress cones and Faraday cage.
- Void filling stress relief mastics are not necessary.
- Proven shield continuity concept. The neutral wires are connected externally. The integrated pre-expanded neutral sock is connected to the neutral wires by a constant force spring. This provides the metallic shielding system to the cable joint.
- The joint accepts both mechanical and compression connectors.
- Meets IEEE-404 requirements for 15 kV through 35 kV.

Each silicone splice body is factory tested to include AC withstand and partial discharge in accordance with IEEE-404 production tests.

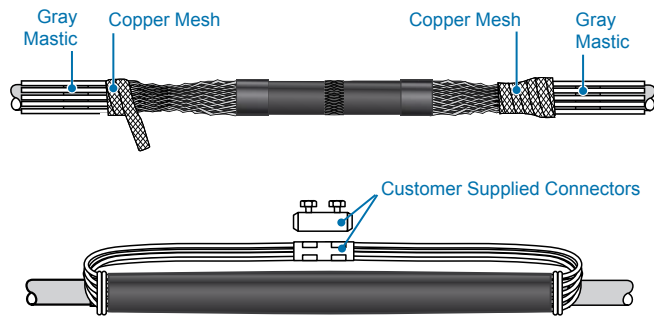

#### Ordering Information

1. Selections are based on the typical dimensions of 100% insulated cables, manufactured in accordance with AEIC standard. Nominal insulation thickness (100%): 15 kV: 175mils, 25 kV: 260mils, 35 kV: 345mils.
2. Select the appropriate catalog number. Use the insulation OD, jacket OD and the neutral sock equivalent range as the final ordering criteria. To ensure proper parking diameter, calculate jacket OD with concentric neutrals folded back over jacket.
3. For mechanical shear bolt connector included in the kit confirm the correct connector selection according to the Min/Max diameter over the cable conductor from the tables.
4. For other applications or if you have any questions, contact your TE Connectivity representative.
5. Standard package: 1 kit/box
6. Related test report: EDR-5430, EDR-5455
7. For AI Mechanical ShearBolt connector information request data sheet 9-1773440-4 and for CU request 165972.



Selection Information: dimensions in inches (millimeters)

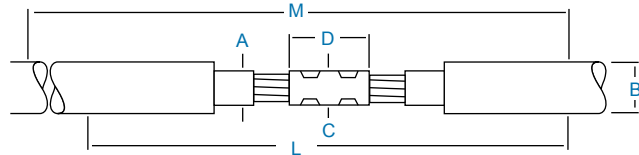

Catalog Number	Voltage Class	Nominal Cable Range	Insulation O.D. (Min.-Max.)		Jacket O.D. (Max.)	Maximum Connector Dimensions		Kit Installed Length L	Required Installation Space M
			A	B	C	D			
<b>CSJA JCN/EG Joint Without Connector</b>									
CSJA-JCN/EG-1511	15 kV	#2-350	0.69-1.20 (17.5-30.5)	1.50 (38.1)	1.30 (33.0)	5.50 (140.0)	29 (737)	37 (940)	
CSJA-JCN/EG-1512	15 kV	4/0-750	0.87-1.40 (22.1-35.6)	1.80 (46.0)	1.50 (38.0)	5.50 (140.0)	29 (737)	37 (940)	
CSJA-JCN/EG-1513	15 kV	350-1000	1.03-1.58 (26.2-40.0)	2.05 (52.1)	1.65 (42.0)	6.69 (170.0)	33 (838)	41 (1041)	
CSJA-JCN/EG-1514	15 kV	750-1250	1.28-2.05 (32.50-52.0)	2.60 (66.0)	1.85 (47.0)	7.90 (200.0)	37 (939)	48 (1219)	
CSJA-JCN/EG-2812	28 kV	#1-500	0.87-1.40 (22.1-35.6)	1.80 (46.0)	1.50 (38.0)	5.50 (140.0)	29 (737)	37 (940)	
CSJA-JCN/EG-2813	28 kV	4/0-750	1.03-1.58 (26.20-40.0)	2.05 (52.1)	1.65 (42.0)	6.69 (170.0)	33 (838)	41 (1041)	
CSJA-JCN/EG-2814	28 kV	500-1250	1.28-2.05 (32.50-52.0)	2.60 (66.0)	1.85 (47.0)	7.90 (200.0)	37 (939)	48 (1219)	
CSJA-JCN/EG-3513	35 kV	1/0-350	1.03-1.49 (26.20-37.8)	2.05 (52.1)	1.40 (35.6)	5.50 (140.0)	33 (838)	41 (1041)	
CSJA-JCN/EG-3514	35 kV	350-1000	1.36-2.05 (34.54-52.0)	2.60 (66.0)	1.96 (50.0)	7.90 (200.0)	37 (939)	48 (1219)	
CSJA-JCN/EG-3515	35 kV	750-1250	1.63-2.36 (41.40-60.0)	2.60 (66.0)	2.36 (60.0)	7.90 (200.0)	37 (939)	48 (1219)	

Catalog Number	Voltage Class	Nominal Cable Range	Insulation O.D. (Min.-Max.)		Jacket O.D. (Max.)	Min/Max Diameter Over Cable Conductor*		Kit Installed Length L	Required Installation Space M
			A	B	E				
<b>CSJA JCN/EG Joint With Copper Mechanical ShearBolt Connector</b>									
CSJA-JCN/EG-1511M1	15 kV	2/0-350	0.69-1.20 (17.5-30.5)	1.50 (38.1)	0.376-0.736 (9.50-18.7)	29 (737)	37 (940)		
CSJA-JCN/EG-1512M1	15 kV	4/0-500	0.87-1.40 (22.1-35.6)	1.80 (46.0)	0.376-0.736 (9.50-18.7)	29 (737)	37 (940)		
CSJA-JCN/EG-1512M2	15 kV	350-750	0.87-1.40 (22.1-35.6)	1.80 (46.0)	0.570-0.945 (14.5-24.0)	29 (737)	37 (940)		
CSJA-JCN/EG-1513M2	15 kV	350-750	1.03-1.58 (26.2-40.0)	2.05 (52.1)	0.570-0.945 (14.5-24.0)	33 (838)	41 (1041)		
CSJA-JCN/EG-2812M1	28 kV	2/0-500	0.87-1.40 (22.1-35.6)	1.80 (46.0)	0.376-0.736 (9.50-18.7)	29 (737)	37 (940)		
CSJA-JCN/EG-2813M2	28 kV	350-750	1.03-1.58 (26.2-40.0)	2.05 (52.1)	0.570-0.945 (14.5-24.0)	33 (838)	41 (1041)		
CSJA-JCN/EG-2814M2	28 kV	500-750	1.28-2.05 (32.50-52.0)	2.60 (66.0)	0.570-0.945 (14.5-24.0)	37 (939)	48 (1219)		
CSJA-JCN/EG-3513M1	35 kV	2/0-350	1.03-1.49 (26.20-37.8)	2.05 (52.1)	0.376-0.736 (9.50-18.7)	33 (838)	41 (1041)		
CSJA-JCN/EG-3514M2	35 kV	350-750	1.36-2.05 (34.54-52.0)	2.60 (66.0)	0.570-0.945 (14.5-24.0)	37 (939)	48 (1219)		

\* Min/max diameter over cable conductor accepted by the copper mechanical connector.

<b>CSJA JCN/EG Joint With Aluminum Mechanical ShearBolt Connector</b>									
CSJA-JCN/EG-1511M4	15 kV	#2-3/0	0.69-1.20 (17.5-30.5)	1.50 (38.1)	0.268-0.470 (6.80-11.9)	29 (737)	37 (940)		
CSJA-JCN/EG-1511M5	15 kV	#2-350	0.69-1.20 (17.5-30.5)	1.50 (38.1)	0.268-0.681 (6.80-17.3)	29 (737)	37 (940)		
CSJA-JCN/EG-1512M6	15 kV	4/0-500	0.87-1.40 (22.1-35.6)	1.80 (46.0)	0.423-0.813 (10.7-20.6)	29 (737)	37 (940)		
CSJA-JCN/EG-1512M7	15 kV	500-750	0.87-1.40 (22.1-35.6)	1.80 (46.0)	0.736-0.998 (18.7-25.3)	29 (737)	37 (940)		
CSJA-JCN/EG-1513M8	15 kV	350-750	1.03-1.58 (26.20-40.0)	2.05 (52.1)	0.616-0.998 (15.7-25.3)	33 (838)	41 (1041)		
CSJA-JCN/EG-1514M9	15 kV	750-1000	1.28-2.05 (32.50-52.0)	2.60 (66.0)	0.813-1.152 (20.6-29.2)	37 (939)	48 (1219)		
CSJA-JCN/EG-2812M5	28 kV	#1-350	0.87-1.40 (22.1-35.6)	1.80 (46.0)	0.268-0.681 (6.80-17.3)	29 (737)	39 (990)		
CSJA-JCN/EG-2812M6	28 kV	4/0-500	0.87-1.40 (22.1-35.6)	1.80 (46.0)	0.423-0.813 (10.7-20.6)	29 (737)	39 (990)		
CSJA-JCN/EG-2813M8	28 kV	350-750	1.03-1.58 (26.20-40.0)	2.05 (52.1)	0.616-0.998 (15.7-25.3)	33 (838)	41 (1041)		
CSJA-JCN/EG-2814M8	28 kV	500-750	1.28-2.05 (32.50-52.0)	2.60 (66.0)	0.616-0.998 (15.7-25.3)	37 (939)	48 (1219)		
CSJA-JCN/EG-2814M9	28 kV	750-1000	1.28-2.05 (32.50-52.0)	2.60 (66.0)	0.813-1.152 (20.60-29.2)	37 (939)	48 (1219)		
CSJA-JCN/EG-3513M5	35 kV	1/0-350	1.03-1.49 (26.20-37.8)	2.05 (52.1)	0.268-0.681 (6.8-17.3)	33 (838)	41 (1041)		
CSJA-JCN/EG-3514M8	35 kV	350-750	1.36-2.05 (34.54-52.0)	2.60 (66.0)	0.616-0.998 (15.7-25.3)	37 (939)	48 (1219)		
CSJA-JCN/EG-3514M9	35 kV	750-1000	1.36-2.05 (34.54-52.0)	2.60 (66.0)	0.813-1.152 (20.60-29.2)	37 (939)	48 (1219)		
CSJA-JCN/EG-3515M9	35 kV	750-1000	1.63-2.36 (41.40-60.0)	2.60 (66.0)	0.813-1.152 (20.60-29.2)	37 (939)	48 (1219)		
CSJA-JCN/EG-3515M10	35 kV	1000-1250	1.63-2.36 (41.40-60.0)	2.60 (66.0)	0.060-1.251 (23.0-31.7)	37 (939)	48 (1219)		

\* Min/max diameter over cable conductor accepted by the aluminum mechanical connector.



C\_CSJG

## CSJG In-line Cold Shrinkable Joints for Specifically for all 1/C Jacketed Concentric Neutral Cables (15-35 kV)

TE Connectivity's Raychem introduces the CSJG cold shrinkable joint for 15 kV through 35 kV. It is designed to splice jacketed concentric neutral (JCN) cables. The splice consists of a pre-expanded silicone body on a unique holdout design and separate re-jacketing system.

This design is easy to install with minimal steps and short installation time. The re-jacketing system is a cold-applied wraparound sleeve designed to seal the entire splice and provide mechanical and environmental protection for direct buried installation. Both mechanical and compression connectors can be used.

- A pre-expanded, single piece silicone rubber body with high mechanical expansion capability which allows a wide application range.
- An ergonomically designed spiral holdout provides a smooth installation with low release forces.
- Integrated electrical stress control enhanced by factory molded stress cones and a Faraday cage.
- The joint and re-jacketing system are both qualified to the latest revision of IEEE-404.
- Each silicone splice body is factory tested to include AC withstand and partial discharge in accordance with IEEE-404 production tests.

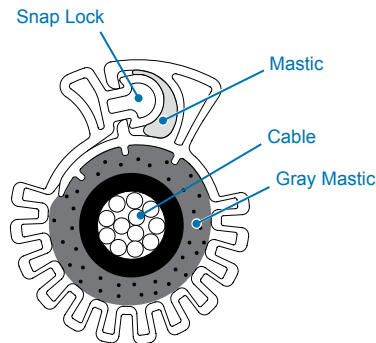
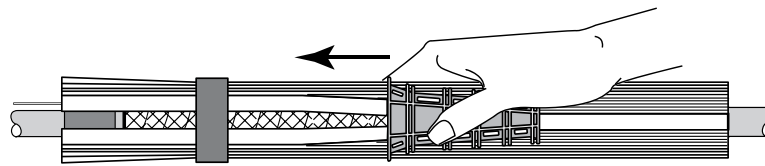
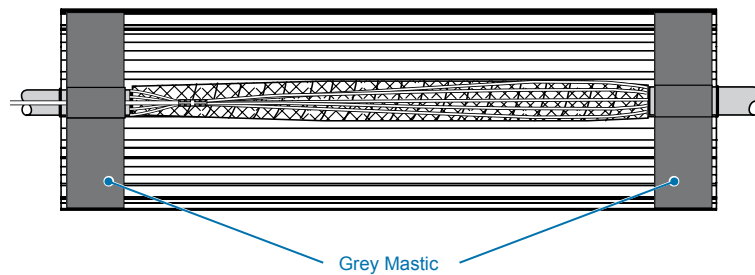

### Ordering Information

1. Selections are based on the typical dimensions of 100% insulated cables, manufactured in accordance with AEIC standard. Nominal insulation thickness (100%): 15 kV: 175 mils, 25 kV: 260 mils, 35 kV: 345 mils.
2. Select the appropriate catalog number. Use the insulation OD and jacket OD range as the final ordering criteria.
3. For mechanical shear bolt connector included in the kit confirm the correct connector selection according to the Min/Max diameter over the cable conductor from the tables.
4. Standard package: 1 kit/box.
5. Related test reports: EDR-5430, EDR-5507, EDR-5455.

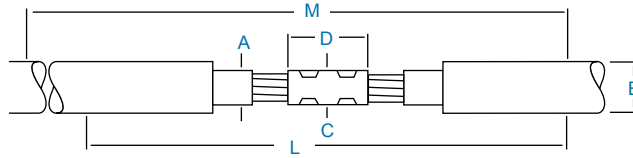

Catalog Number	Voltage Class	Nominal Cable Range	Min/Max Insulation OD		Connector Dimensions		Kit Installed Length	Required Installation Space				
			A		C	D			L	M		
<b>CSJG Joint without Connector</b>												
CSJG-1511	15 kV	#2-350	0.69-1.20	(17.5-30.50)	1.30	(33.0)	5.50	(140.0)	33	(850)	42	(1060)
CSJG-1512	15 kV	4/0-750	0.87-1.40	(22.1-35.60)	1.50	(38.0)	5.50	(140.0)	33	(850)	42	(1060)
CSJG-1513	15 kV	350-1000	1.03-1.58	(26.2-40.0)	1.65	(42.0)	6.69	(170.0)	41	(1050)	50	(1270)
CSJG-1514	15 kV	750-1250	1.28-2.05	(32.50-52.0)	1.85	(47.0)	7.90	(200.0)	41	(1050)	55	(1390)
CSJG-2812	28 kV	#1-500	0.87-1.40	(22.1-35.60)	1.50	(38.0)	5.50	(140.0)	33	(850)	42	(1060)
CSJG-2813	28 kV	4/0-750	1.03-1.58	(26.20-40.0)	1.65	(42.0)	6.69	(170.0)	41	(1050)	50	(1270)
CSJG-2814	28 kV	500-1250	1.28-2.05	(32.50-52.0)	1.85	(47.0)	7.90	(200.0)	41	(1050)	55	(1390)
CSJG-3513	35 kV	1/0-350	1.03-1.49	(26.20-37.80)	1.40	(35.6)	5.50	(140.0)	41	(1050)	50	(1270)
CSJG-3514	35 kV	350-1000	1.36-2.05	(34.54-52.0)	1.96	(50.0)	7.90	(200.0)	41	(1050)	55	(1390)
CSJG-3515	35 kV	750-1250	1.63-2.36	(41.40-60.0)	2.36	(60.0)	7.90	(200.0)	41	(1050)	55	(1390)

Catalog Number	Voltage Class	Nominal Cable Range	Min/Max Insulation OD		Min/Max Diameter* Over Cable Conductor*		Kit Installed Length	Required Installation Space		
			A		E				L	M
<b>CSJG Joint with Copper Shearbolt Connector</b>										
CSJG-1511M1	15 kV	2/0-350	0.69-1.20	(17.5-30.50)	0.376-0.736	(9.50-18.70)	33	(850)	42	(1060)
CSJG-1512M1	15 kV	4/0-500	0.87-1.40	(22.1-35.60)	0.376-0.736	(9.50-18.70)	33	(850)	42	(1060)
CSJG-1512M2	15 kV	350-750	0.87-1.40	(22.1-35.60)	0.570-0.945	(14.5-24.0)	33	(850)	42	(1060)
CSJG-1513M2	15 kV	350-750	1.03-1.58	(26.2-40.0)	0.570-0.945	(14.5-24.0)	41	(1050)	50	(1270)
CSJG-2812M1	28 kV	2/0-500	0.87-1.40	(22.1-35.60)	0.376-0.736	(9.50-18.70)	33	(850)	42	(1060)
CSJG-2813M2	28 kV	350-750	1.03-1.58	(26.2-40.0)	0.570-0.945	(14.5-24.0)	41	(1050)	50	(1270)
CSJG-2814M2	28 kV	500-750	1.28-2.05	(32.50-52.0)	0.570-0.945	(14.5-24.0)	41	(1050)	55	(1390)
CSJG-3513M1	35 kV	2/0-350	1.03-1.49	(26.20-37.80)	0.376-0.736	(9.50-18.70)	41	(1050)	50	(1270)
CSJG-3514M2	35 kV	350-750	1.36-2.05	(34.54-52.0)	0.570-0.945	(14.5-24.0)	41	(1050)	55	(1390)

\* Min/max diameter over cable conductor accepted by the copper mechanical connector.

Catalog Number	Voltage Class	Nominal Cable Range	Min/Max Insulation OD		Min/Max Diameter* Over Cable Conductor*		Kit Installed Length	Required Installation Space		
			A		E				L	M
<b>CSJG Joint with Aluminum Shearbolt Connector</b>										
CSJG-1511M4	15 kV	#2-3/0	0.69-1.20	(17.5-30.50)	0.268-0.470	(6.80-11.9)	33	(850)	42	(1060)
CSJG-1511M5	15 kV	#2-350	0.69-1.20	(17.5-30.50)	0.268-0.681	(6.80-17.3)	33	(850)	42	(1060)
CSJG-1512M6	15 kV	4/0-500	0.87-1.40	(22.1-35.60)	0.423-0.813	(10.7-20.6)	33	(850)	42	(1060)
CSJG-1512M7	15 kV	500-750	0.87-1.40	(22.1-35.60)	0.736-0.998	(18.7-25.3)	33	(850)	42	(1060)
CSJG-1513M8	15 kV	350-750	1.03-1.58	(26.20-40.0)	0.616-0.998	(15.7-25.3)	41	(1050)	50	(1270)
CSJG-1514M9	15 kV	750-1000	1.28-2.05	(32.50-52.0)	0.813-1.152	(20.6-29.2)	41	(1050)	55	(1390)
CSJG-2812M5	28 kV	#1-350	0.87-1.40	(22.1-35.60)	0.268-0.681	(6.80-17.3)	33	(850)	42	(1060)
CSJG-2812M6	28 kV	4/0-500	0.87-1.40	(22.1-35.60)	0.423-0.813	(10.7-20.6)	33	(850)	42	(1060)
CSJG-2813M8	28 kV	350-750	1.03-1.58	(26.20-40.0)	0.616-0.998	(15.7-25.3)	41	(1050)	50	(1270)
CSJG-2814M8	28 kV	500-750	1.28-2.05	(32.50-52.0)	0.616-0.998	(15.7-25.3)	41	(1050)	55	(1390)
CSJG-2814M9	28 kV	750-1000	1.28-2.05	(32.50-52.0)	0.813-1.152	(20.60-29.2)	41	(1050)	55	(1390)
CSJG-3513M5	35 kV	1/0-350	1.03-1.49	(26.20-37.80)	0.268-0.681	(6.8-17.3)	41	(1050)	50	(1270)
CSJG-3514M8	35 kV	350-750	1.36-2.05	(34.54-52.0)	0.616-0.998	(15.7-25.3)	41	(1050)	55	(1390)
CSJG-3514M9	35 kV	750-1000	1.36-2.05	(34.54-52.0)	0.813-1.152	(20.60-29.2)	41	(1050)	55	(1390)
CSJG-3515M10	35 kV	1000-1250	1.63-2.36	(41.40-60.0)	1.060-1.251	(23.0-31.7)	41	(1050)	55	(1390)

\* Min/max diameter over cable conductor accepted by the aluminum mechanical connector.

## In-Line Cold-Applied Splice



C\_3C\_CSJA

### 3/C CSJA

#### Cold Shrinkable Joint for 3/C Armored Cables (15-35 kV)

Raychem's CSJA cold shrinkable joint for 15 kV through 35 kV is designed to splice 3/C armored cables. The splice consists of three pre-expanded silicone bodies on a unique holdout and a separate re-jacketing system.

This design is easy to install with minimal steps and a short installation time. The re-jacketing system is a cold-applied wraparound sleeve designed to seal the entire splice and provide mechanical and environmental protection for direct buried installations. Both mechanical and compression connectors can be used.

- A pre-expanded, single piece silicone rubber body with high mechanical expansion capability which allows a wide application range.
- An ergonomically designed spiral holdout provides a smooth installation with low release forces
- Integrated electrical stress control enhanced by factory molded stress cones and a Faraday cage
- The joint and re-jacketing system are both qualified to the latest revision of IEEE-404
- Each silicone splice body is factory tested to include AC withstand and partial discharge in accordance with IEEE-404 production tests.
- The GMRS re-jacketing system is a cold-applied wrap around sleeve that eliminates parking distance required with traditional re-jacketing. It is designed to seal the entire splice and provide mechanical and environmental protection for direct buried and submersible applications.

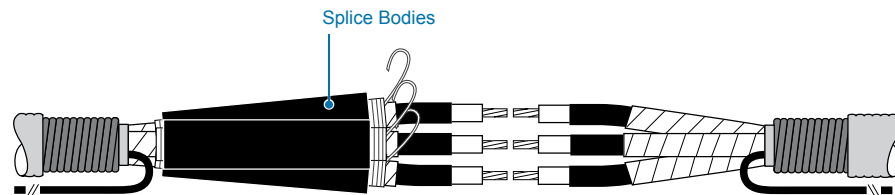

#### Ordering Information

1. Selections are based on the typical dimensions of 100% insulated cables, manufactured in accordance with AEIC standard. Nominal insulation thickness (100%): 15 kV: 175 mils, 25 kV: 260 mils, 35 kV: 345 mils.
2. Select the appropriate catalog number. Use the insulation OD and jacket OD range as the final ordering criteria.
3. For mechanical ShearBolt connector included in the kit confirm the correct connector selection according to the Min./Max. diameter over the cable conductor from the tables.
4. Standard package: 1 kit/box.
5. Related test reports: EDR-5530.

Selection Information: dimensions in inches (millimeters)

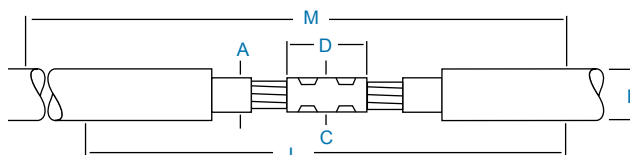

Catalog Number	Voltage Class	Nominal Cable Range	Min/Max Insulation OD A	Connector Dimensions		Kit Installed Length L	Required Installation Space M
				Max. OD C	Max. Length D		
<b>CSJA 3/C Joint without Connector</b>							
CSJA-3-1521-ARMR	15 kV	#2-350	0.69-1.20 (17.5-30.5)	1.30 (33.0)	5.50 (140.0)	65 (1650)	65 (1650)
CSJA-3-1522-ARMR	15 kV	4/0-750	0.87-1.40 (22.1-35.6)	1.50 (38.0)	5.50 (140.0)	65 (1650)	65 (1650)
CSJA-3-1523-ARMR	15 kV	350-1000	1.03-1.58 (26.2-40.0)	1.65 (42.0)	6.69 (170.0)	71 (1800)	71 (1800)
CSJA-3-2822-ARMR	28 kV	#1-500	0.87-1.40 (22.1-35.6)	1.50 (38.0)	5.50 (140.0)	65 (1650)	65 (1650)
CSJA-3-2823-ARMR	28 kV	4/0-750	1.03-1.58 (26.2-40.0)	1.65 (42.0)	6.69 (170.0)	71 (1800)	71 (1800)
CSJA-3-3523-ARMR	35 kV	1/0-350	1.03-1.49 (26.2-37.8)	1.40 (35.6)	5.50 (140.0)	71 (1800)	71 (1800)
CSJA-3-3524-ARMR	35 kV	350-500	1.36-1.06 (34.5-40.6)	1.96 (50.0)	7.90 (200.0)	71 (1800)	71 (1800)

Number Catalog	Voltage Class	Nominal Cable Range	Min/Max Insulation OD A	Min/Max Diameter* Over Cable Conductor E	Kit Installed Length L	Required Installation Space M
CSJA-3-1521M1-ARMR	15 kV	2/0-350	0.69-1.20 (17.5-30.5)	0.376-0.736 (9.5-18.7)	65 (1650)	65 (1650)
CSJA-3-1522M1-ARMR	15 kV	4/0-500	0.87-1.40 (22.1-35.6)	0.376-0.736 (9.5-18.7)	65 (1650)	65 (1650)
CSJA-3-1522M2-ARMR	15 kV	350-750	0.87-1.40 (22.1-35.6)	0.570-0.945 (14.5-24.0)	71 (1800)	71 (1800)
CSJA-3-1523M3-ARMR	15 kV	500-1000	1.03-1.58 (26.2-40.0)	0.736-1.152 (18.7-29.3)	71 (1800)	71 (1800)
CSJA-3-2822M1-ARMR	28 kV	2/0-500	0.87-1.40 (22.1-35.6)	0.376-0.736 (9.5-18.7)	65 (1650)	65 (1650)
CSJA-3-2823M2-ARMR	28 kV	350-750	1.03-1.58 (26.2-40.0)	0.570-0.945 (14.5-24.0)	71 (1800)	71 (1800)
CSJA-3-3523M1-ARMR	35 kV	2/0-350	1.03-1.49 (26.2-37.8)	0.376-0.736 (9.5-18.7)	71 (1800)	71 (1800)
CSJA-3-3524M2-ARMR	35 kV	350-500	1.36-1.60 (34.5-40.6)	0.570-0.945 (14.5-24.0)	71 (1800)	71 (1800)

\* Min/max diameter over cable conductor accepted by the copper mechanical connector.

Number Catalog	Voltage Class	Nominal Cable Range	Min/Max Insulation OD A	Min/Max Diameter* Over Cable Conductor E	Kit Installed Length L	Required Installation Space M
CSJA-3-1521M4-ARMR	15 kV	#2-3/0	0.69-1.20 (17.5-30.5)	0.268-0.470 (6.8-11.9)	65 (1650)	65 (1650)
CSJA-3-1521M5-ARMR	15 kV	#2-350	0.69-1.20 (17.5-30.5)	0.268-0.681 (6.8-17.3)	65 (1650)	65 (1650)
CSJA-3-1522M6-ARMR	15 kV	4/0-500	0.87-1.40 (22.1-35.6)	0.423-0.813 (10.7-20.6)	71 (1800)	71 (1800)
CSJA-3-1522M7-ARMR	15 kV	500-750	0.87-1.40 (22.1-35.6)	0.736-0.998 (18.7-25.3)	71 (1800)	71 (1800)
CSJA-3-1523M8-ARMR	15 kV	350-750	1.03-1.58 (26.2-40.0)	0.616-0.998 (15.7-25.3)	71 (1800)	71 (1800)
CSJA-3-2822M5-ARMR	28 kV	#1-350	0.87-1.40 (22.1-35.6)	0.268-0.681 (6.8-17.3)	65 (1650)	65 (1650)
CSJA-3-2822M6-ARMR	28 kV	4/0-500	0.87-1.40 (22.1-35.6)	0.423-0.813 (10.7-20.6)	65 (1650)	65 (1650)
CSJA-3-2823M8-ARMR	28 kV	350-750	1.03-1.58 (26.2-40.0)	0.616-0.998 (15.7-25.3)	71 (1800)	71 (1800)
CSJA-3-3523M5-ARMR	35 kV	1/0-350	1.03-1.49 (26.2-37.8)	0.268-0.681 (6.8-17.3)	71 (1800)	71 (1800)
CSJA-3-3524M8-ARMR	35 kV	350-500	1.36-1.60 (34.5-40.6)	0.616-0.998 (15.7-25.3)	71 (1800)	71 (1800)

\* Min/max diameter over cable conductor accepted by the aluminum mechanical connector.



C\_3C\_CSJA

### 3/C CSJA Cold Shrinkable Joint for 15 kV 3/C TECK Cables

Raychem's CSJA cold shrinkable joint for 15 kV 3/C TECK cables. The joint consists of three pre-expanded silicone bodies on a unique holdout and a separate re-jacketing system.

This design is easy to install with minimal steps and a short installation time. The cold-applied wraparound GMRS re-jacketing system is designed to seal the entire splice and provide mechanical and environmental protection for direct buried and submersible installations. Both mechanical and compression connectors can be used.

- Single piece silicone rubber body for wide application range
- Integrated electrical stress control via factory molded stress cones and a Faraday cage
- Joint, re-jacketing sleeve, and body all qualified to IEEE-404
- Easy release spiral holdout
- Robust re-jacketing solution eliminates parking distance

**Selection Information: dimensions in inches (millimeters)**

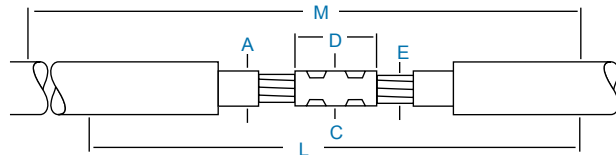

Catalog Number	Voltage Class	Nominal Cable Range	Min/Max Insulation OD A	Connector Dimensions		Kit Installed Length L	Required Installation Space M
				Max. OD B	Max. Length C		
<b>CSJA 3/C no connector, for TECK cable</b>							
CSJA-3-1521-TECK	15 kV	#2-350	0.69-1.20 (17.5-30.5)	1.30 (33.0)	5.50 (140.0)	65 (1650)	65 (1650)
CSJA-3-1522-TECK	15 kV	4/0-750	0.87-1.40 (22.1-35.6)	1.50 (38.0)	5.50 (140.0)	65 (1650)	65 (1650)
CSJA-3-1523-TECK	15 kV	350-1000	1.03-1.58 (26.2-40.0)	1.65 (42.0)	6.69 (170.0)	71 (1800)	71 (1800)

Catalog Number	Voltage Class	Nominal Cable Range	Min/Max Insulation OD A	Min/Max Diameter Over Cable Conductor*		Kit Installed Length L	Required Installation Space M
				E	F		
<b>CSJA 3/C Copper Shearbolt Connector, for TECK cable</b>							
CSJA-3-1521M1-TECK	15 kV	2/0-350	0.69-1.20 (17.5-30.5)	0.376-0.736 (9.5-18.7)		65 (1650)	65 (1650)
CSJA-3-1522M1-TECK	15 kV	4/0-500	0.87-1.40 (22.1-35.6)	0.376-0.736 (9.5-18.7)		65 (1650)	65 (1650)
CSJA-3-1522M2-TECK	15 kV	350-750	0.87-1.40 (22.1-35.6)	0.570-0.945 (14.5-24.0)		71 (1800)	71 (1800)
CSJA-3-1523M3-TECK	15 kV	500-1000	1.03-1.58 (26.2-40.0)	0.736-1.152 (18.7-29.3)		71 (1800)	71 (1800)

Catalog Number	Voltage Class	Nominal Cable Range	Min/Max Insulation OD A	Min/Max Diameter Over Cable Conductor*		Kit Installed Length L	Required Installation Space M
				E	F		
<b>CSJA 3/C Aluminum Shearbolt Connector, for TECK cable</b>							
CSJA-3-1521M4-TECK	15 kV	#2-3/0	0.69-1.20 (17.5-30.5)	0.268-0.470 (6.8-11.9)		65 (1650)	65 (1650)
CSJA-3-1521M5-TECK	15 kV	#2-350	0.69-1.20 (17.5-30.5)	0.268-0.681 (6.8-17.3)		65 (1650)	65 (1650)
CSJA-3-1522M6-TECK	15 kV	4/0-500	0.87-1.40 (22.1-35.6)	0.423-0.813 (10.7-20.6)		71 (1800)	71 (1800)
CSJA-3-1522M7-TECK	15 kV	500-750	0.87-1.40 (22.1-35.6)	0.736-0.998 (18.7-25.3)		71 (1800)	71 (1800)
CSJA-3-1523M8-TECK	15 kV	350-750	1.03-1.58 (26.2-40.0)	0.616-0.998 (15.7-25.3)		71 (1800)	71 (1800)

\* Min/max diameter over cable conductor accepted by the copper or aluminum mechanical connector.

**Ordering Information**

1. Selections are based on the typical dimensions of 100% insulated cables, manufactured in accordance with AEIC standard. Nominal insulation thickness (100%): 15kV: 175mils, 25kV: 260mils, 35kV: 345mils.
2. Select the appropriate catalog number. Use the insulation OD and jacket OD range as the final ordering criteria.
3. For mechanical shear bolt connector included in the kit confirm the correct connector selection according to the Min/Max diameter over the cable conductor from the tables.
4. Standard package: 1 kit/box.
5. Related test reports: EDR-5530.



C\_HVT\_50

## HVT-50 1/C and 3/C Non-Shielded Power Cable (5 kV)

Raychem HVT-50 non-shielded polymeric terminations are designed to withstand rigorous service conditions. The nontracking, heat-shrinkable insulation is simple to install and provides excellent UV stability.

### Selection Information: dimensions in inches (millimeters)

Catalog Number	Conductor Size (AWG/kcmil)	Insulation Diameter (Min.)	Jacket O.D. (Max.)
HVT-51	#4-2/0	0.45 (11)	0.85 (22)
HVT-52	3/0-500	0.70 (18)	1.30 (33)
HVT-53	750-1500	1.10 (28)	2.15 (55)

Installed length: 12 (300)

### For Three-Conductor 5 kV Terminations

- Order three appropriate single-conductor terminations from the selection information above.
- In addition, order the appropriate three-conductor modification kit (MOD-3-HVT) as follows:
  - MOD-3A-HVT for HVT-51 and HVT-52
  - MOD-3B-HVT for HVT-53
 These MOD-3-HVT kits contain:
  - 4 feet of tubing to re-jacket each phase and ground conductor
  - sealant
  - plugs
  - cable breakout to seal the crotch area

### Ordering Information

- Select the appropriate catalog number. All selections are based on the typical dimensions of 100% insulated cables manufactured in accordance with the data contained in ICEA S-66-524, as well as the dimensions of commonly used connectors. Nominal insulation thickness (100%): 90 mils.
- For cables manufactured to other specifications, confirm selection with cable dimensions.
- Kits do not contain connectors; order compression or solder connectors separately.
- Standard package:
  - HVT-50: 3 single-conductor kits/box.
  - MOD-3-HVT: 1 kit/box.
- Cable mounting brackets are available to accommodate cable diameters from 0.80-2.40 inches (20-61 mm).



C\_HVT-Z-J-SJ

## HVT-Z-J/SJ

### Terminations with Built-in Stress Control for Jacketed Concentric Neutral Cables

The Raychem HVT-Z medium voltage termination system features a co-extruded one-piece termination. Unlike the HVT product line, which includes a non-tracking tube and a separate stress control tube, the HVT-Z termination consists of the same proven non-tracking tube together with a co-extruded, built-in stress control grading layer. This stress control layer is based on ceramic semiconductor technology (ZnO) and provides superior discharge and impulse performance. When the tubing is shrunk down, the coating softens and sticks to irregular surfaces, providing moisture seals as well as electrical stress control. The termination design provides a superior product with a shorter overall length and fewer rain sheds than the HVT product line.

- Reliable, field proven performance
- Slim profile and lightweight, can be installed upright or inverted
- Non-tracking material is maintenance free even in highly polluted environments
- Fully qualified Class 1 termination per IEEE-48 for a long, trouble free service life
- Unlimited shelf life

#### Selection Information: dimensions in inches (millimeters)

Indoor Kit	Outdoor Kit	Conductor Size (Min.-Max.)		Insulation Diameter (Min.-Max.)	Jacket O.D. (Max.)
		<b>15 kV</b>	<b>15 kV (133%)</b>		
HVT-Z-151-J	HVT-Z-151-SJ	#2-#1 AWG		0.60-0.95	1.05
HVT-Z-152-J	HVT-Z-152-SJ	#2/0-250 kcmil	#2-4/0 AWG	0.80-1.05	1.45
HVT-Z-153-J	HVT-Z-153-SJ	350-500 kcmil	250-500 kcmil	1.05-1.40	1.90
HVT-Z-154-J	HVT-Z-154-SJ	750-1000 kcmil	750-1000 kcmil	1.25-2.00	2.50
<i>Installed Length 11.5' (300)</i>					
		<b>25 kV/35 kV</b>	<b>25 kV</b>	<b>35 kV</b>	
HVT-Z-252/352-J	HVT-Z-252/352-SJ	#1-3.0 AWG		0.80-1.05	1.45
HVT-Z-253/353-J	HVT-Z-253/353-SJ	#4/0-500 kcmil	#1/0-4/0 AWG	0.05-1.40	1.90
HVT-Z-254/354-J	HVT-Z-254/354-SJ	750-1000 kcmil	250-1000 kcmil	1.25-2.00	2.50

*Installed Length 20' (500)*

#### Ordering Information

1. Select the appropriate catalog number. All selections are based on the typical dimensions of 100% and 133% insulated cables manufactured in accordance with the data contained in AEIC CS5 and AEIC CS6, as well as the dimensions of commonly used connectors. Nominal Insulation thickness (100%): 15 kV: 175 mils, 25 kV: 260 mils, 35 kV: 345 mils. Nominal thickness (133%): 15 kV: 220 mils.
2. For cables manufactured to other specifications, confirm selection with cable dimensions.
3. Kits do not contain connectors. Order compression or solder connectors separately.
4. Indoor (-J) kits are suitable for unjacketed and jacketed URD cable.
5. Outdoor (-SJ) kits include skirts for outdoor use and are suitable for unjacketed and jacketed URD cable. To order skirts refer to Accessory and Tool section.
6. Cable mounting brackets are available to accommodate cable diameters from 0.80-2.40 inches (20-46 mm) refer to Accessory and Tools section for ordering information.
7. Standard package: 1 kit/box.
8. Refer to the Application and Technical Specification section for testing information.
9. Related test reports:  
Outdoor: 15 kV: EDR-5323, 25-35 kV: EDR-5338.  
Indoor: 15 kV: EDR-5322, 25-35 kV: EDR5338.

**NOTE: If Legacy HVT Product is required please contact your local TE Connectivity sales representative.**





C\_HVT-Z

## HVT-Z High Voltage Termination for shielded cables

The Raychem HVT-Z high voltage termination system features a new, co-extruded one-piece termination. The main termination stress control consists of the proven Raychem non-tracking tube together with a co-extruded stress control grading layer. This stress control layer is based on ceramic semi-conductor technology (ZnO) and provides superior discharge and impulse performance. When the tubing is shrunk down, the coating softens and sticks to irregular surfaces, providing moisture seals as well as electrical stress control. HVT-Z high-voltage terminations are fully qualified per IEEE-48 as Class I terminations to provide a long, trouble-free service life.

### Optional ShearBolt Terminal

As an option, the HVT-Z can also be ordered with TE Connectivity's new line of Aluminum ShearBolt Terminals. These are range taking mechanical connectors that will accommodate a conductor range from #2 compact to 1000 kcmil stranded, Class B.

### Selection Information: dimensions in inches (millimeters)

Indoor	Outdoor Kit	Conductor Size (Min.-Max.)		Insulation Diameter (Min.-Max.)	Jacket O.D. (Max.)
<i>For Copper Tape Shield, Wire Shield, UniShield and Lead Sheath Cables</i>					
<b>5/8 kV</b>		<b>5 kV (0.90")</b>	<b>8 kV (0.115")</b>		
HVT-Z-80-G/SG		#4-#1 AWG	#6-#2 AWG	0.35-0.60 (9-15)	0.95 (24)
HVT-Z-81-G/SG		1/0 AWG-250 kcmil	#1-4/0 AWG	0.60-0.95 (15-24)	1.20 (30)
HVT-Z-82-G/SG		300-500 kcmil	250-500 kcmil	0.80-1.25 (20-32)	1.50 (38)
HVT-Z-83-G/SG		600-1750 kcmil	600-1750 kcmil	1.10-1.75 (28-44)	2.10 (53)
HVT-Z-84-G/SG		1500-3500 kcmil	1500-2500 kcmil	1.60-2.45 (41-62)	2.75 (70)
<i>Installed Length 11.5" (295)</i>		<i>Can be cut shorter for use with MCK kits</i>		<i>No Skirts for Outdoor Operation</i>	
<b>15 kV</b>		<b>15 kV (.175-.220")</b>			
HVT-Z-151-G	HVT-Z-151-SG	#4-1/0 AWG		0.60-0.95 (15-24)	1.20 (30)
HVT-Z-152-G	HVT-Z-152-SG	2/0 AWG-350 kcmil		0.80-1.25 (20-32)	1.50 (38)
HVT-Z-153-G	HVT-Z-153-SG	400-1000 kcmil		1.10-1.75 (28-44)	2.10 (53)
HVT-Z-154-G	HVT-Z-154-SG	1250-2500 kcmil		1.60-2.45 (41-62)	2.75 (70)
<i>Installed Length 11.5" (295)</i>				<i>1 Skirt for Outdoor Operation</i>	
<b>25 kV/35 kV</b>		<b>25 kV (0.260")</b>	<b>35 kV (0.345")</b>		
HVT-Z-252/352-G	HVT-Z-252/352-SG	#2 AWG-250 kcmil	#1-1/0 AWG	0.80-1.25 (20-32)	1.50 (38)
HVT-Z-253/353-G	HVT-Z-253/353-SG	300-750 kcmil	2/0 AWG-500 kcmil	1.10-1.75 (28-44)	2.10 (53)
HVT-Z-254/354-G	HVT-Z-254/354-SG	1000-2000 kcmil	750-1750 kcmil	1.60-2.45 (41-62)	2.75 (70)
<i>Installed Length 19.0" (485)</i>				<i>4 Skirts for Outdoor Operation</i>	
<i>Kits Include ShearBolt Terminal</i>					
<b>5/8 kV</b>		<b>5 kV</b>	<b>8 kV</b>		
HVT-Z-81-G/SG-T5		1/0 AWG-250 kcmil	#1-4/0 AWG	0.60-0.95 (15-24)	1.20 (30)
HVT-Z-82-G/SG-T5		300-350 kcmil	250-350 kcmil	0.80-1.07 (20-27)	1.50 (38)
HVT-Z-82-G/SG-T8		350-500 kcmil	350-500 kcmil	0.85-1.25 (22-32)	1.50 (38)
HVT-Z-83-G/SG-T9		600-1000 kcmil	600-1000 kcmil	1.10-1.40 (28-36)	2.10 (53)
				<i>No Skirts for Outdoor Operation</i>	
<b>15 kV</b>		<b>15 kV</b>			
HVT-Z-151-G-T5	HVT-Z-151-SG-T5	#2-1/0 AWG		0.65-0.95 (17-24)	1.20 (30)
HVT-Z-152-G-T5	HVT-Z-152-SG-T5	2/0 AWG-350 kcmil		0.80-1.25 (20-32)	1.50 (38)
HVT-Z-153-G-T8	HVT-Z-153-SG-T8	400-500 kcmil		1.10-1.355 (28-34)	2.10 (53)
HVT-Z-153-G-T9	HVT-Z-153-SG-T9	600-1000 kcmil		1.215-1.65 (32-42)	2.10 (53)
				<i>1 Skirt for Outdoor Operation</i>	
<b>25 kV/35 kV</b>		<b>25 kV (0.260")</b>	<b>35 kV (0.345")</b>		
HVT-Z-252/352-G-T5	HVT-Z-252/352-SG-T5	#2 AWG-250 kcmil	#1-1/0 AWG	0.80-1.25 (20-32)	1.50 (38)
HVT-Z-253/353-G-T5	HVT-Z-253/353-SG-T5	300-350 kcmil	2/0 AWG-350 kcmil	1.10-1.50 (28-38)	2.0 (51)
HVT-Z-253/353-G-T8	HVT-Z-253/353-SG-T8	350-750 kcmil	350-500 kcmil	1.185-1.70 (30-43)	2.10 (53)
HVT-Z-254/354-G-T9	HVT-Z-254/354-SG-T9	600-1000 kcmil	600-1000 kcmil	1.60-1.79 (41-45)	2.75 (70)
				<i>4 Skirts for Outdoor Operation</i>	

## Heat-Shrink Terminations

### Selection Information: dimensions in inches (millimeters)

Indoor	Outdoor Kit	Conductor Size (Min.-Max.)		Insulation Diameter (Min.-Max.)	Jacket O.D. (Max.)
<b>For Copper Tape Shield, Wire Shield, UniShield and Lead Sheath Cables</b>					
<b>5/8 kV</b>		<b>5 kV (0.90")</b>	<b>8 kV (0.115")</b>		
HVT-Z-80-G/SG		#4-#1 AWG	#6-#2 AWG	0.35-0.60 (9-15)	0.95 (24)
HVT-Z-81-G/SG		1/0 AWG-250 kcmil	#1-4/0 AWG	0.60-0.95 (15-24)	1.20 (30)
HVT-Z-82-G/SG		300-500 kcmil	250-500 kcmil	0.80-1.25 (20-32)	1.50 (38)
HVT-Z-83-G/SG		600-1750 kcmil	600-1750 kcmil	1.10-1.75 (28-44)	2.10 (53)
HVT-Z-84-G/SG		1500-3500 kcmil	1500-2500 kcmil	1.60-2.45 (41-62)	2.75 (70)
<i>Installed Length 11.5" (295)</i>		<i>Can be cut shorter for use with MCK kits</i>		<i>No Skirts for Outdoor Operation</i>	
<b>15 kV</b>		<b>15 kV (.175-.220")</b>			
HVT-Z-151-G	HVT-Z-151-SG	#4-1/0 AWG		0.60-0.95 (15-24)	1.20 (30)
HVT-Z-152-G	HVT-Z-152-SG	2/0 AWG-350 kcmil		0.80-1.25 (20-32)	1.50 (38)
HVT-Z-153-G	HVT-Z-153-SG	400-1000 kcmil		1.10-1.75 (28-44)	2.10 (53)
HVT-Z-154-G	HVT-Z-154-SG	1250-2500 kcmil		1.60-2.45 (41-62)	2.75 (70)
<i>Installed Length 11.5" (295)</i>				<i>1 Skirt for Outdoor Operation</i>	
<b>25 kV/35 kV</b>		<b>25 kV (0.260")</b>	<b>35 kV (0.345")</b>		
HVT-Z-252/352-G	HVT-Z-252/352-SG	#2 AWG-250 kcmil	#1-1/0 AWG	0.80-1.25 (20-32)	1.50 (38)
HVT-Z-253/353-G	HVT-Z-253/353-SG	300-750 kcmil	2/0 AWG-500 kcmil	1.10-1.75 (28-44)	2.10 (53)
HVT-Z-254/354-G	HVT-Z-254/354-SG	1000-2000 kcmil	750-1750 kcmil	1.60-2.45 (41-62)	2.75 (70)
<i>Installed Length 19.0" (485)</i>				<i>4 Skirts for Outdoor Operation</i>	
<b>Kits Include ShearBolt Terminal</b>					
<b>5/8 kV</b>		<b>5 kV</b>	<b>8 kV</b>		
HVT-Z-81-G/SG-T5		1/0 AWG-250 kcmil	#1-4/0 AWG	0.60-0.95 (15-24)	1.20 (30)
HVT-Z-82-G/SG-T5		300-350 kcmil	250-350 kcmil	0.80-1.07 (20-27)	1.50 (38)
HVT-Z-82-G/SG-T8		350-500 kcmil	350-500 kcmil	0.85-1.25 (22-32)	1.50 (38)
HVT-Z-83-G/SG-T9		600-1000 kcmil	600-1000 kcmil	1.10-1.40 (28-36)	2.10 (53)
				<i>No Skirts for Outdoor Operation</i>	
<b>15 kV</b>		<b>15 kV</b>			
HVT-Z-151-G-T5	HVT-Z-151-SG-T5	#2-1/0 AWG		0.65-0.95 (17-24)	1.20 (30)
HVT-Z-152-G-T5	HVT-Z-152-SG-T5	2/0 AWG-350 kcmil		0.80-1.25 (20-32)	1.50 (38)
HVT-Z-153-G-T8	HVT-Z-153-SG-T8	400-500 kcmil		1.10-1.355 (28-34)	2.10 (53)
HVT-Z-153-G-T9	HVT-Z-153-SG-T9	600-1000 kcmil		1.215 -1.65 (32-42)	2.10 (53)
				<i>1 Skirt for Outdoor Operation</i>	
<b>25 kV/35 kV</b>		<b>25 kV (0.260")</b>	<b>35 kV (0.345")</b>		
HVT-Z-252/352-G-T5	HVT-Z-252/352-SG-T5	#2 AWG-250 kcmil	#1-1/0 AWG	0.80-1.25 (20-32)	1.50 (38)
HVT-Z-253/353-G-T5	HVT-Z-253/353-SG-T5	300-350 kcmil	2/0 AWG-350 kcmil	1.10-1.50 (28-38)	2.0 (51)
HVT-Z-253/353-G-T8	HVT-Z-253/353-SG-T8	350-750 kcmil	350-500 kcmil	1.185-1.70 (30-43)	2.10 (53)
HVT-Z-254/354-G-T9	HVT-Z-254/354-SG-T9	600-1000 kcmil	600-1000 kcmil	1.60-1.79 (41-45)	2.75 (70)
				<i>4 Skirts for Outdoor Operation</i>	



C\_MOD\_3HVT

## MOD-3-HVT

### 3/C Modification Kits for Raychem Medium-Voltage Terminations (5-35 kV)

Use TE's Raychem MOD-3-HVT kits in conjunction with three 1/C terminations to seal and re-jacket the cable terminations. MOD-3-HVT kits are available for both unsealed and sealed applications.

#### Selection Information: dimensions in inches (millimeters)

Indoor (Without Breakout Boot)		Outdoor/Indoor (Includes Breakout Boot)	
1/C Termination Indoor	MOD-3-HVT Kit	1/C Termination	MOD-3-HVT Kit
<b>5-8 kV</b>		<b>In/Outdoor Sealed</b>	
HVT-Z-80-G/SG	MOD-3X-HVT*	HVT-Z-80-G/SG	MOD-3A-HVT*
HVT-Z-81-G/SG	MOD-3X-HVT	HVT-Z-81-G/SG	MOD-3A-HVT
HVT-Z-82-G/SG	MOD-3X-HVT	HVT-Z-82-G/SG	MOD-3A-HVT
HVT-Z-83-G/SG	MOD-3Y-HVT	HVT-Z-83-G/SG	MOD-3B-HVT
HVT-Z-84-G/SG	MOD-3Y-HVT	HVT-Z-84-G/SG	MOD-3B-HVT*
<b>15 kV</b>			
HVT-Z-151-G	MOD-3X-HVT	HVT-Z-151-SG	MOD-3A-HVT
HVT-Z-152-G	MOD-3X-HVT	HVT-Z-152-SG	MOD-3A-HVT
HVT-Z-153-G	MOD-3Y-HVT	HVT-Z-153-SG	MOD-3B-HVT
HVT-Z-154-G	MOD-3Y-HVT	HVT-Z-154-SG	MOD-3B-HVT*
<b>25 kV and 35 kV</b>			
HVT-Z-252/352-G	MOD-3X-HVT	HVT-Z-252/352-G	MOD-3A-HVT
HVT-Z-253/353-G	MOD-3Y-HVT	HVT-Z-253/353-G	MOD-3B-HVT
HVT-Z-254/354-G	MOD-3Y-HVT	HVT-Z-254/354-G	MOD-3B-HVT*

\*Refer to Selection information (#3) below this table.

Catalog Number	Insulation Diameter (Min.-Max.)	Jacket O.D. (Min.-Max.)
MOD-3X-HVT (unsealed)	0.50-1.35 (13-34)	
MOD-3Y-HVT (unsealed)	1.00-2.70 (25-69)	
MOD-3A-HVT (sealed)	0.50-1.25 (13-32)	1.25-3.85 (32-98)
MOD-3B-HVT (sealed)	1.00-2.10 (25-53)	2.65-5.30 (67-135)

#### Ordering Information

- To select the appropriate modification kit for the HVT terminations, use the MOD-3-HVT selection table above.
- Use the MOD-3-HVT dimensions table to confirm the insulation and jacket diameters. If the diameters of your cable fall outside the MOD-3-HVT kit's use range, you can purchase MOD-3-HVT components separately. To order separately, use the ordering information on the next page.

## Heat-Shrink Terminations

### 3/C Cable Terminating

MOD-3X-HVT and MOD-3Y-HVT are for jacketing of phases and ground conductors. MOD-3A-HVT and MOD-3B-HVT provide jacketing, plus an environmental crotch sealing boot. Tubing provided does not have sealant coating on the inner wall. This makes it easy to remove, like any cable jacket. Each kit includes three 4-foot long sleeves for the phases and three 4-foot long smaller sleeves for any ground conductors. (Tubing can be field-cut to appropriate length.) A unique six-legged cable breakout

boot, provided in -3A and -3B kits, has an internal coating of a special adhesive to provide total environmental sealing of the cable crotch (breakout) area. It has three large legs for the phases and three smaller legs for ground conductors. Plugs are included for insertion into any unused ground legs to maintain the environmental seal integrity.

### 3/C Mod Kit for Converting One 3/C Cable to Three 1/C Cables

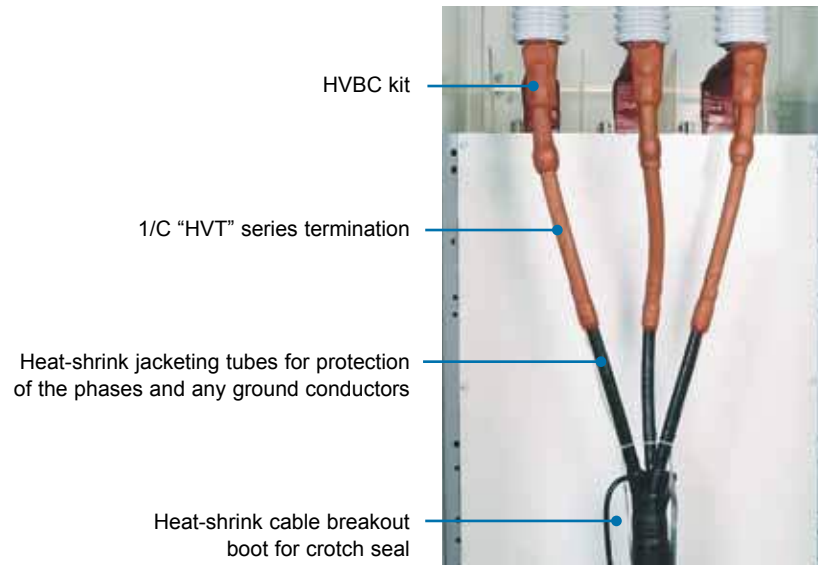

C\_MODHVT\_I\_3

### MOD-3-HVT Kit Components and Bulk Ordering Information

Catalog Number	Kit Components	Component Catalog Number	Bulk Ordering Catalog Number
MOD-3X-HVT	Uncoated tubing to rejack each phase	3 each MWTM-35/12-1200/U	MWTM-35/12-A/U
	Uncoated tubing to rejack each ground	3 each MWTM-16/5-1500/U	MWTM-16/5-A/U
	Sealant strip	1 each S1085-3-380	S1085-3-380
MOD-3Y-HVT	Uncoated tubing to rejack each phase	3 each MWTM-85/25-1500/U	LVIT-75/25-A/U
	Uncoated tubing to rejack each ground	3 each MWTM-16/5-1200/U	MWTM-16/5-A/U
	Sealant strip	1 each S1085-3-380	S1085-3-380
MOD-3A-HVT	Uncoated tubing to rejack each phase	3 each MWTM-35/12-1200/U	MWTM-35/12-A/U
	Uncoated tubing to rejack each ground	3 each MWTM-16/5-1200/U	MWTM-16/5-A/U
	Sealant strip	1 each S1085-3-380	S1085-3-380
	Cable breakout boot	1 each CBR-6-1-A	CBR-6-1-A
	Cable breakout plugs	3 each CBR-PLUG	CBR-PLUG
	Sealant-coated shim tubing	1 each WCSM-70/21-150-S	WCSM-70/21-1200-S
MOD-3B-HVT	Uncoated tubing to rejack each phase	3 each MWTM-85/25-1500/U	LVIT-75/25-A/U
	Uncoated tubing to rejack each ground	3 each MWTM-16/5-1200/U	MWTM-16/5-A/U
	Sealant strip	1 each S1085-3-380	S1085-3-380
	Cable breakout boot	1 each CBR-6-2-A	CBR-6-2-A
	Cable breakout plugs	3 each CBR-PLUG	CBR-PLUG
	Ground wire shim tubing	3 each WCSM-20/6-150-S	WCSM-20/6-150-S (B50)

Note: MOD-3-HVT kits should be installed prior to installing TE Connectivity HVT kits.

### Ordering Information

- Standard package: 1 kit/box.
- Kit contents: Unsealed (-3X and -3Y) kits contain re-jacketing tubes for phase and ground conductors, and sealant for indoor terminations that don't require environmental sealing. Sealed (-3A and -3B) kits contain re-jacketing tubes, sealant, a cable breakout, and plugs for both outdoor and indoor terminations.
- Kit components can be purchased in bulk quantities.



C\_HVT-Z-LC

## HVT-Z-LC/SLC 1/C LC Shield Cable (15-35 kV)

The Raychem HVT-Z-LC/SLC heat-shrinkable termination is designed using a stress grading material Zinc Oxide (ZnO) that is used in conjunction with our surge arrester research. The use of ZnO as the stress control system has made it possible for us to offer a one piece termination and an overall shorter length than the HVT.

- Reliable, field proven performance
- Slim profile and lightweight, can be installed upright or inverted
- Non-tracking material is maintenance free even in highly polluted environments
- Fully qualified Class 1 termination per IEEE-48 for a long, trouble free service life
- Unlimited shelf life

### Selection Information: dimensions in inches (millimeters)

Catalog Number	Conductor Size (AWG/kcmil)	Insulation Diameter (Min.-Max.)	Jacket O.D. (Max.)
<b>15 kV</b>			
HVT-Z-151-LC/SLC	#4-1/0	0.65-0.95 (5-24)	1.20 (30)
HVT-Z-152-LC/SLC	2/0-350	0.85-1.25 (22-32)	1.50 (38)
HVT-Z-153-LC/SLC	400-1000	1.10-1.75 (28-44)	2.10 (53)
HVT-Z-154-LC/SLC	1250-2500	1.60-2.45 (41-62)	2.75 (70)

### Ordering Information

1. Select the appropriate catalog number. All selections are based on the typical dimensions of 100% insulated and 133% insulated cables manufactured in accordance with the data contained in AEIC CS5 and AEIC CS6 as well as the dimensions of commonly used connectors. Nominal insulation thickness: (100%) 15 kV: 175 mils, 25 kV: 260 mils, 35 kV: 345 mils. Nominal insulation thickness: (133%) 15 kV: 220 mils.
2. For cables manufactured to other specifications, confirm selection with cable dimensions.
3. HVT-LC/SLC kits are supplied with two pieces of #4 AWG braid to provide fault-current carrying capacity. Users should verify the compatibility of the braids with their LC shield cable.
4. Kits do not contain connectors; order compression or solder connectors separately.
5. Indoor (-LC) kits include a solderless ground connection.
6. Outdoor (-SLC) kits include skirts for outdoor use and a solderless ground connection. Skirts sold separately. For skirt ordering information refer to the Accessory & Tool section.
7. Cable Mounting brackets are available to accommodate cable diameters from 0.80-2.40 inches (20-46 mm). Refer to Accessory & Tool section for ordering information.
8. Standard package: 1 kit/box
9. For testing information refer to the Application and Technical Specification Section.
10. Related test reports: Indoor: 15 kV: EDR-5322, Outdoor: 15 kV: EDR-5323



C\_HVT-Z

## HVT-ZL High Voltage Termination

Raychem HVT-ZL high voltage termination system is based on the HVT-Z termination and still features the new, co-extruded one-piece termination. The HVT-ZL is intended for applications that require longer installation. This may include coastal environments or legacy HVT installations. The main termination component consists of the proven Raychem non-tracking tube together with a co-extruded stress control grading layer. This stress control layer is based on ceramic semi-conductor technology (ZnO) and provides superior discharge and impulse performance. When the tubing is shrunk down, the coating softens and sticks to irregular surfaces, providing moisture seals as well as electrical stress control.

### Selection Information: dimensions in inches (millimeters)

Catalog Number		Conductor Size (Min. - Max.)		Insulation Diameter (Min. - Max.)	Jacket O.D. (Max.)
Indoor	Outdoor Kit				
<b>5/8 kV</b>		<b>5 kV (0.90")</b>		<b>8 kV (0.115")</b>	
HVT-ZL-80-G	HVT-ZL-80-SG	#4 #1 AWG	#6 #2 AWG	0.35-0.60 (9-15)	0.95 (24)
HVT-ZL-81-G	HVT-ZL-81-SG	1/0 AWG-250 kcmil	#1-4/0 AWG	0.60-0.95 (15-24)	1.20 (30)
HVT-ZL-82-G	HVT-ZL-82-SG	300-500 kcmil	250-500 kcmil	0.80-1.25 (20-32)	1.50 (38)
HVT-ZL-83-G	HVT-ZL-83-SG	600-1750 kcmil	600-1750 kcmil	1.10-1.75 (28-44)	2.10 (53)
HVT-ZL-84-G	HVT-ZL-84-SG	1500-2500 kcmil	2000-2500 kcmil	1.60-2.45 (41-62)	2.75 (70)

Installed Length 10.5" (267 mm)

<b>15 kV</b>		<b>15 kV (.175-.220")</b>			
HVT-ZL-151-G	HVT-ZL-151-SG	#4-1/0 AWG		0.60-0.95 (15-24)	1.20 (30)
HVT-ZL-152-G	HVT-ZL-152-SG	2/0 AWG-350 kcmil		0.80-1.25 (20-32)	1.50 (38)
HVT-ZL-153-G	HVT-ZL-153-SG	400-1000 kcmil		1.10-1.65 (28-44)	2.10 (53)
HVT-ZL-154-G	HVT-ZL-154-SG	1250-2500 kcmil		1.60-2.45 (41-62)	2.75 (70)

Installed Length 15.0" (381 mm)

<b>25 kV</b>		<b>25 kV (0.260")</b>			
HVT-ZL-252-G	HVT-ZL-252-SG	#2 AWG-250 kcmil		0.80-1.25 (20-32)	1.50 (38)
HVT-ZL-253-G	HVT-ZL-253-SG	300-750 kcmil		1.10-1.70 (28-43)	2.10 (53)
HVT-ZL-254-G	HVT-ZL-254-SG	1000-2000 kcmil		1.60-2.45 (41-62)	2.75 (70)
HVT-ZL-255-G	HVT-ZL-255-SG	2000-2500 kcmil		2.05-3.00 (52-76)	3.45 (88)

Installed Length 28.0" (711 mm)

<b>35 kV</b>		<b>35 kV (0.345")</b>			
HVT-ZL-352-G	HVT-ZL-352-SG	#1-1/0 AWG		0.80-1.25 (20-32)	1.50 (38)
HVT-ZL-353-G	HVT-ZL-353-SG	2/0 AWG-500 kcmil		1.10-1.75 (28-44)	2.10 (53)
HVT-ZL-354-G	HVT-ZL-354-SG	750-1750 kcmil		1.60-2.45 (41-62)	2.75 (70)
HVT-ZL-355-G	HVT-ZL-355-SG	2000-2500 kcmil		2.05-3.00 (52-76)	3.45 (88)

Installed Length 33.0" (838 mm)

### Testing Chart

Product and Voltage Class Test Description	HVT-Z-80 Series (5-8 kV)	HVT-Z-150 Series (15 kV)	HVT-Z-250 & 350 Series (25-35 kV)
AC Withstand, 1 minute, (kV)	35	60	90
DC Withstand, 15 minutes (kV)	65	75	140
Partial Discharge (min. kV) for 3 pc or less	9	15.6	36
Impulse withstand 1.2 X 50 us, crest kV	95	110	200
Continuous current rating	Equal to cable ampacity		
Wet withstand, 10 seconds, kV rms.	30	45	80
Dry withstand, 6 hours, kV rms.	25	35	75

### Test Reports

Voltage Class	Indoor	Outdoor
5/8/15 kV	EDR-5322	EDR-5323-A
25/28/35 kV	EDR-5337	EDR-5338



C\_HVT\_HVTE\_G

## HVT/HVT-3 15 kV Terminations, (1/C, 3/C) PILC/VCLC

TE's Raychem HVT-1590-G/SG and HVT-3-1590-G/SG series heat-shrinkable high voltage terminations combine proven oil-sealing capabilities with stress-control and nontracking technologies to terminate 15 kV 1/C and 3/C PILC/VCLC cables.

The HVT-1590-G/SG and HVT-3-1590-G/SG heat-shrinkable terminations install quickly and easily, with no need for special adapters, compound filling, leadwiping, or hot oils. The HVT-1590-G/SG and HVT-3-1590-G terminations are fully qualified to applicable sections of IEEE-48 to provide a long, trouble-free product life. In addition, these terminations have been pressure tested to perform at 110°C and 15 psi under load-cycling conditions.

- Rated to IEEE-48, class 1 termination
- Accommodates belted or shielded paper-insulated, lead-covered (PILC) or varnished cambric-insulated (VCLC) cable

### Selection Information: dimensions in inches (millimeters)

Catalog Number		Conductor Size (AWG/kcmil)	Insulation Diameter (Min.)	Max Lead Sheath O.D.	Min. Lug O.D.	Min. Lug barrel Length	Installed Length	
Indoor	Outdoor						Indoor	Outdoor
<b>HVT-1590-G/SG 1/C PILC/VCLC Cable</b>								
HVT-1591-G	HVT-1591-SG	#4-2/0	0.60 (15)	0.95 (24)	0.51 (13)	1.50 (38)	22.4 (570)	22.4 (570)
HVT-1592-G	HVT-1592-SG	3/0-400	0.85 (22)	1.25 (32)	0.65 (16)	1.50 (38)	22.4 (570)	22.4 (570)
HVT-1593-G	HVT-1593-SG	400-1000	1.00 (25)	1.65 (42)	0.95 (24)	1.50 (38)	23.6 (600)	23.6 (600)
HVT-1594-G	HVT-1594-SG	1250-2000	1.75 (44)	2.20 (56)	1.25 (32)	1.50 (38)	23.6 (600)	23.6 (600)

Catalog Number		Conductor Size (AWG/kcmil)	Insulation Diameter (Min.)	Installed Length		Outdoor (Min.)	Outdoor (Max.)
Indoor	Outdoor			Indoor (Min.)	Max.)		
<b>HVT-3-1590-G/SG 3/C PILC/VCLC Cable</b>							
HVT-3-1591-G	HVT-3-1591-SG	#4-4/0	0.60 (15)	31.5 (800)	35 (888)	28 (711)	40 (1015)
HVT-3-1592-G	HVT-3-1592-SG	4/0-400	0.85 (22)	31.5 (800)	35 (888)	28 (711)	40 (1015)
HVT-3-1593-G	HVT-3-1593-SG	500-800	1.00 (25)	31.5 (800)	35 (888)	28 (711)	40 (1015)

### Ordering Information

1. Select the appropriate catalog number. Selections are based on the typical dimensions of 100% insulated cables manufactured in accordance with AEIC standard. Nominal insulation thickness (100%): 165 mils
2. Lugs are not supplied in the kits and should be ordered separately. Use oil block lugs only.
3. Standard package quantity: 1 kit (Each 3/C kit contains all components required to terminate one 3/C PILC cable) per box.
4. Related test report: EDR-5245
5. Cable mounting brackets are available to accommodate cable diameters from 0.80-4.50 inches (20-115 mm).



C\_HVT-M

## HVT-M Flexible Cable Termination (5-25 kV)

TE Connectivity's Raychem HVT-M heat-shrinkable terminations for mining cables provide for nontracking termination of 5-25 kV MP-GC and SHD-GC flexible cables.

- Proven, nontracking insulation surface can withstand the rigors of long-term electrical stress and surface pollution while maintaining its overall performance.
- For outdoor applications in polluted and dusty environments, the creepage path is quickly extended by simply installing heat-shrinkable skirts.
- The tubing and molded parts shrink quickly, providing a tight fit and minimizing downtime.
- Rated to IEEE-48, class 1, for indoor or outdoor use: High-voltage, nontracking terminations for standard flexible and mining cables (MP-GC and SHD-GC).

### Selection Information: dimensions in inches (millimeters)

Catalog Number		Power conductor size (AWG/kcmil)			
		5 kV		8 kV	
Indoor	Outdoor	3/C MP-GC	3/C SHD-GC	3/C MP-GC	3/C SHD-GC
<b>5-8 kV</b>					
HVT-M-581	HVT-M-581-S	#2-3/0	#6-2/0	#4-2/0	#4-#1
HVT-M-582	HVT-M-582-S	4/0-350	3/0-300	3/0-350	1/0-300
HVT-M-583	HVT-M-583-S	500-750	350-500	500-750	350-500
		<b>15 kV</b>			
HVT-M-151	HVT-M-151-S	#2-4/0	#2-3/0		
HVT-M-152	HVT-M-152-S	250-500	4/0-500		
		<b>25 kV</b>			
HVT-M-251	HVT-M-251-S	#1-250	#1-4/0		
HVT-M-252	HVT-M-252-S	350-500	250-500		

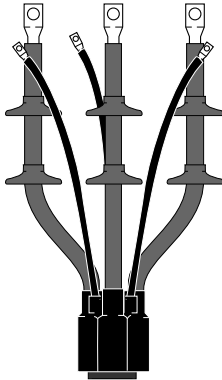

### Ordering Information

1. Select the appropriate catalog number based on conductor size for your cable type. Confirm selection with cable diameter range.
2. Kits do not contain connectors; please order separately.
3. "S" (outdoor) kits include skirts (rain sheds).
4. For longer tail lengths or for cable types not listed in this catalog, contact your local TE Connectivity representative.
5. Standard package: One 3/C kit/box.
6. Related test reports:  
5/8 kV: EDR-5217,  
15 kV: EDR-5218,  
25 kV: EDR-5219
7. Cable mounting brackets are available to accommodate cable diameters from 0.80-4.50 inches (20-115 mm).





C\_TFT-R

## TFT-R

### 1/C Terminations for Shielded and Non-Shielded Power Cable (5-35 kV)

TE Connectivity's Raychem TFT-R and TFT-RG/SG tool-free termination kits have been developed to provide a quick and easy, cold-applied method of terminating 5-35 kV, single conductor polymeric cables. Both the TFT-R and TFT-R-SG are designed for indoor and outdoor conditions.

TFT-R kits are for non-shielded cable applications. TFT-R-G kits do not have rain sheds and should be used for 5/8 kV indoor or outdoor applications and 15 kV indoor only applications.

- Advanced Metal Oxide Matrix stress control
- Positive placement of stress control patch
- Provided on a crush-resistant core
- Easy installation — allows for repositioning
- Rated to IEEE-48, class 1 termination requirements.

#### Selection Information: dimensions in inches (millimeters)

Installed Length  
5/8/15 kV (without sheds)

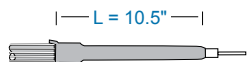

15 kV (with sheds)

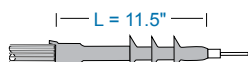

25 kV (with sheds)

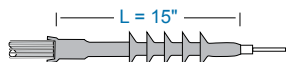

35 kV (with sheds)

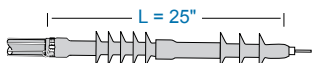

Catalog Number	Cable Range (AWG/kcmil)	Insulation Diameter (Min./Max.)	Number of Skirts	Std. Pack (Kits/Box)
<b>TFT-P-R Shielded, Indoor - Push on Installation (5 kV/8 kV)</b>				
TFT-P-80R	#6 - #2 AWG	0.39 - 0.61 (10-16)		
<b>TFT-R Non-Shielded, Indoor/Outdoor - Without Sheds (5 kV)</b>				
TFT-50R	#2-3/0 AWG	0.53-0.80 (13-20)	0	3
TFT-51R	1/0-250 kcmil	0.64-1.09 (16-28)	0	3
TFT-52R	250-500 kcmil	0.85-1.45 (22-37)	0	3
TFT-53R	350-750 kcmil	1.06-1.70 (27-43)	0	3
<b>TFT-R-G Shielded, Indoor/Outdoor - Without Sheds (5 kV)</b>				
TFT-150R-G	#2-3/0 AWG	0.53-0.80 (13-20)	0	3
TFT-151R-G	2/0-250 kcmil	0.64-1.09 (16-28)	0	3
TFT-152R-G	350-500 kcmil	0.85-1.45 (22-37)	0	3
TFT-153R-G	500-750 kcmil	1.06-1.70 (27-43)	0	3
<b>TFT-R-G Shielded, Indoor/Outdoor - Without Sheds (8 kV)</b>				
TFT-150R-G	#2-3/0 AWG	0.53-0.80 (13-20)	0	3
TFT-151R-G	1/0-250 kcmil	0.64-1.09 (16-28)	0	3
TFT-152R-G	250-500 kcmil	0.85-1.45 (22-37)	0	3
TFT-153R-G	500-750 kcmil	1.06-1.70 (27-43)	0	3
<b>TFT-R-G Shielded, Indoor Only - Without Sheds (15 kV)</b>				
TFT-150R-G	#2-3/0 AWG	0.53-0.80 (13-20)	0	3
TFT-151R-G	#2-250 kcmil	0.64-1.09 (16-28)	0	3
TFT-152R-G	4/0-500 kcmil	0.85-1.45 (22-37)	0	3
TFT-153R-G	500-750 kcmil	1.06-1.70 (27-43)	0	3
<b>TFT-R-SG Shielded, Indoor/Outdoor (15 kV)</b>				
TFT-151R-SG	#2-250 kcmil	0.64-1.09 (16-28)	3	3
TFT-152R-SG	4/0-500 kcmil	0.85-1.45 (22-37)	3	3
TFT-153R-SG	500-750 kcmil	1.06-1.70 (27-43)	3	3
TFT-154R-SG	1000-1250 kcmil	1.49-2.20 (38-56)	3	3
<b>TFT-R-SG Shielded, Indoor/Outdoor (25 kV)</b>				
TFT-251R-SG	#1-3/0 AWG	0.64-1.09 (16-28)	5	3
TFT-252R-SG	#2/0-500 kcmil	0.85-1.45 (22-37)	5	3
TFT-253R-SG	250-750 kcmil	1.06-1.70 (27-43)	5	3
TFT-254R-SG	750-1250 kcmil	1.49-2.20 (38-56)	5	3
<b>TFT-R-SG Shielded, Indoor/Outdoor (35 kV)</b>				
TFT-352R-SG	1/0-250 kcmil	0.85-1.45 (22-37)	8	3
TFT-353R-SG	4/0-500 kcmil	1.06-1.70 (27-43)	8	3
TFT-354R-SG	500-1250 kcmil	1.49-2.20 (38-56)	8	3

#### Ordering Information

1. All shielded cable kits contain a solder-blocked ground braid and a solderless ground clamp.
2. Selections are based on the typical dimensions of 100% insulated cables and the dimensions of commonly used connectors manufactured in accordance with AEIC standard. Nominal insulation thickness (100%): 15 kV: 175 mils, 25 kV: 260 mils, 35 kV: 345 mils
3. For cables manufactured to other specifications, confirm cable dimensions.
4. Kits do not contain connectors; order compression or solder connectors separately.
5. Related test reports: 15 kV: EDR-5302 (outdoor), 15 kV: EDR-5306 (indoor), 25 kV: EDR-5303, 35 kV: EDR-5299
6. Cable mounting brackets are available to accommodate cable diameters from 0.80-2.40 inches (20-61 mm).
7. For three conductor cables, order MOD-3-TFT kits.



C\_TFT-E

## TFT-E 1/C Termination for Shielded Power Cable (15-35 kV)

These elastomeric medium voltage cable terminations are designed for customers who want TE Connectivity's Raychem material technology with a cold applied termination. This termination features an advanced stress control system using metal oxide matrix technology providing superior electrical performance.

The TFT-E system has an elastomeric housing with integral sheds that is formulated for long term performance in typical extreme termination environments. The housing comes on a pre-lubricated, crush resistant holdout for simple installation. The superior elastomeric housing, together with the positively positioned stress control system and moisture sealing mastic, provide reliable and consistent installations.

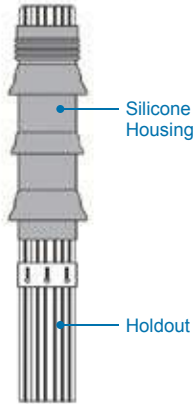

- Material does not degrade in outdoor applications
- Provides excellent electrical performance and prevents misplacement of stress control system
- Prevents collapsing due to rough handling
- Quick and easy installation in confined spaces
- Seals out moisture and contamination
- Aluminum ShearBolts are available in 35 kV class terminations

Rated to IEEE, class 1 termination requirements.

Class 1 termination requirements include the following:

Insulation Class	6 h AC	DEV	BIL	DC
15 kV	35 kV	13 kV	110 kV	75 kV
25 kV	55 kV	21.5 kV	150 kV	105 kV
35 kV	75 kV	30 kV	200 kV	140 kV

Catalog Number	Nominal Conductor Size	Min./Max. Insulation ODs*
TFT-151E/SG/SLC	#2-250 kcmil	0.64-1.09 (16-28)
TFT-152E/SG/SLC	4/0-500 kcmil	0.85-1.45 (22-37)
TFT-153E/SG/SLC	500-750 kcmil	1.06-1.70 (27-43)
TFT-154E/SG/SLC	1000-1250 kcmil	1.49-2.20 (38-56)
TFT-251E/SG/SLC	#1-2/0 AWG	0.64-1.09 (16-28)
TFT-252E/SG/SLC	#2-350 kcmil	0.85-1.45 (22-37)
TFT-253E/SG/SLC	250-750 kcmil	1.06-1.70 (27-46)
TFT-254E/SG/SLC	750-1250 kcmil	1.49-2.20 (38-63)
TFT-352E/SG/SLC	1/0-250 kcmil	0.85-1.45 (22-37)
TFT-353E/SG/SLC	4/0-350 kcmil	1.06-1.70 (27-43)
TFT-354E/SG/SLC	500-1250 kcmil	1.49-2.20 (38-56)

\*Insulation ODs and nominal conductor sizes are based on 100 and 133% concentric stranded cable dimensions.

Kit	Nominal Conductor Size	Min./Max. Insulation ODs	Connector
TFT-353E-T5	1/0-350	1.05-1.48 (26-38)	ASBT-2-350
TFT-354E-T8	350-750	1.36-1.82 (35-46)	ASBT-350-750
TFT-354E-T9	600-1000	1.57-2.20 (40-56)	ASBT-600-1000

### Related Product Information

15 kV Test Report: EDR-5302, 25 kV Test Report: EDR-5303, 35 kV Test Report: EDR-5299

- Packaging: Standard packaging is three terminations per box
- Available accessories: The BRKT series of stainless steel cable mounting brackets are available. Four sizes of bracket accommodate cable diameters from 0.80-2.40 inches (20-61 mm) 3 conductor modification kits.

- The MOD-3-TFT series of three conductor modification kits are available. Kits provide re-jacketing of phase conductors and break out seals.
- Lugs and pin terminals also available.

### Ordering information:

1. The -SG and -SLC kits contain a solder-blocked ground braid and a solderless ground clamp.
2. Select the appropriate catalog number. Selections are based on the typical dimensions of 100% insulated cables and the dimensions of commonly used connectors manufactured in accordance with AEIC standard. Nominal insulation thickness (100%): 15 kV: 175 mils, 25 kV: 260 mils, 35 kV: 345 mils.
3. For cables manufactured to other specifications, confirm selection with cable dimensions.
4. Kits do not contain connectors; order compression or solder connectors separately.
5. Cable mounting brackets are available to accommodate cable diameters from 0.80-2.40 inches (20-61 mm).

Selection Information: dimensions in inches (millimeters)

Installed Length  
5/8/15 kV (without sheds)

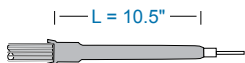

15 kV (with sheds)

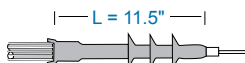

25 kV (with sheds)

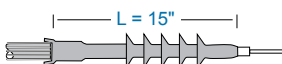

35 kV (with sheds)

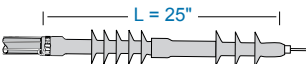

Catalog Number	Cable Range (AWG/kcmil)	Insulation Diameter (Min./Max.)	Number of Skirts	Std. Pack (kits/box)	Hold Out I.D.
<b>CN and JCN Cable - Indoor/Outdoor (15 kV)</b>					
TFT-151E	#2-250	0.64-1.09 (16-28)	3	1 ea.	1.50 (38)
TFT-152E	4/0-500	0.85-1.45 (22-37)	3	1 ea.	1.77 (45)
TFT-153E	500-750	1.06-1.70 (27-43)	3	1 ea.	2.09 (53)
TFT-154E	1000-1250	1.49-2.20 (38-56)	3	1 ea.	2.56 (65)
<b>CN and JCN Cable - Indoor/Outdoor (25 kV)</b>					
TFT-251E	#1-3/0	0.64-1.09 (16-28)	5	1 ea.	1.50 (38)
TFT-252E	#1-500	0.85-1.45 (22-37)	5	1 ea.	1.77 (45)
TFT-253E	250-750	1.06-1.70 (27-43)	5	1 ea.	2.09 (53)
TFT-254E	750-1250	1.49-2.20 (38-56)	5	1 ea.	2.56 (65)
<b>CN and JCN Cable - Indoor/Outdoor (35 kV)</b>					
TFT-352E	1/0-250	0.85-1.45 (22-37)	8	1 ea.	1.77 (45)
TFT-353E	4/0-500	1.06-1.70 (27-43)	8	1 ea.	2.09 (53)
TFT-354E	500-1250	1.49-2.20 (38-56)	8	1 ea.	2.56 (65)
<b>Shielded Cable - Indoor/Outdoor (5 kV No Sheds)</b>					
TFT-151E-G	2/0-250	0.64-1.09 (16-28)	0	3 ea.	1.50 (38)
TFT-152E-G	350-500	0.85-1.45 (22-37)	0	3 ea.	1.77 (45)
TFT-153E-G	500-750	1.06-1.70 (27-43)	0	3 ea.	2.09 (53)
<b>Shielded Cable - Indoor/Outdoor (8 kV No Sheds)</b>					
TFT-151E-G	1/0-250	0.64-1.09 (16-28)	0	3 ea.	1.50 (38)
TFT-152E-G	250-500	0.85-1.45 (22-37)	0	3 ea.	1.77 (45)
TFT-153E-G	500-750	1.06-1.70 (27-43)	0	3 ea.	2.09 (53)
<b>Shielded Cable - Indoor Only (15 kV No Sheds)</b>					
TFT-151E-G	#2-250	0.64-1.09 (16-28)	0	3 ea.	1.50 (38)
TFT-152E-G	4/0-500	0.85-1.45 (22-37)	0	3 ea.	1.77 (45)
TFT-153E-G	500-750	1.06-1.70 (27-43)	0	3 ea.	2.09 (53)
<b>Shielded Cable - Indoor/Outdoor (15 kV)</b>					
TFT-151E-SG	#2-250	0.64-1.09 (16-28)	3	3 ea.	1.50 (38)
TFT-152E-SG	4/0-500	0.85-1.45 (22-37)	3	3 ea.	1.77 (45)
TFT-153E-SG	500-750	1.06-1.70 (27-43)	3	3 ea.	2.09 (53)
TFT-154E-SG	1000-1250	1.49-2.20 (38-56)	3	3 ea.	2.56 (65)
<b>Shielded Cable - Indoor/Outdoor (25 kV)</b>					
TFT-251E-SG	#1-3/0	0.64-1.09 (16-28)	5	3 ea.	1.50 (38)
TFT-252E-SG	#1-500	0.85-1.45 (22-37)	5	3 ea.	1.77 (45)
TFT-253E-SG	250-750	1.06-1.70 (27-43)	5	3 ea.	2.09 (53)
TFT-254E-SG	750-1250	1.49-2.20 (38-56)	5	3 ea.	2.56 (65)
<b>Shielded Cable - Indoor/Outdoor (35 kV)</b>					
TFT-352E-SG	1/0-250	0.85-1.45 (22-37)	8	3 ea.	1.77 (45)
TFT-353E-SG	4/0-500	1.06-1.70 (27-43)	8	3 ea.	2.09 (53)
TFT-354E-SG	500-1250	1.49-2.20 (38-56)	8	3 ea.	2.56 (65)
<b>LC Shielded Cable - Indoor/Outdoor (15 kV)</b>					
TFT-151E-SLC	#2-250	0.64-1.09 (16-28)	3	3 ea.	1.50 (38)
TFT-152E-SLC	4/0-500	0.85-1.45 (22-37)	3	3 ea.	1.77 (45)
TFT-153E-SLC	500-750	1.06-1.70 (27-43)	3	3 ea.	2.09 (53)
TFT-154E-SLC	1000-1250	1.49-2.20 (38-56)	3	3 ea.	2.56 (65)
<b>LC Shielded Cable - Indoor/Outdoor (25 kV)</b>					
TFT-251E-SLC	#1-3/0	0.64-1.09 (16-28)	5	3 ea.	1.50 (38)
TFT-252E-SLC	#1-500	0.85-1.45 (22-37)	5	3 ea.	1.77 (45)
TFT-253E-SLC	250-750	1.06-1.70 (27-43)	5	3 ea.	2.09 (53)
TFT-254E-SLC	750-1250	1.49-2.20 (38-56)	5	3 ea.	2.56 (65)
<b>LC Shielded Cable - Indoor/Outdoor (35 kV)</b>					
TFT-352E-SLC	1/0-250	0.85-1.45 (22-37)	8	3 ea.	1.77 (45)
TFT-353E-SLC	4/0-500	1.06-1.70 (27-43)	8	3 ea.	2.09 (53)
TFT-354E-SLC	500-1250	1.49-2.20 (38-56)	8	3 ea.	2.56 (65)

I.D. - Inside Dimension



C\_MOD\_3\_TFT

### MOD-3-TFT 3/C Modification Kits for Raychem Medium-Voltage Tool Free Terminations (5-35 kV)

Use Raychem MOD-3-TFT kits in conjunction with three Raychem 1/C tool free terminations (TFT) to seal and re-jacket the cable terminations.

MOD-3Z-TFT is for re-jacketing of phase conductors. MOD-3C-TFT and MOD-3D-TFT provide re-jacketing, plus an environmental crotch sealing boot.

Each -3C and -3D kit includes six 1.5 foot pre-stretched tubes on holdouts for the phases. (Tubing can be field-cut to appropriate length). A three-legged cable breakout boot is also pre-stretched on holdouts and has a domed crown. Sealing is insured by pressure sensitive mastic to be applied under the breakout boot body as well as at the tubing interfaces.

The -3Z kit contains three 1.5 foot re-jacketing tubes.

*Note: MOD-3-TFT kits should be installed prior to installing Raychem TFT kits.*

**Selection Information: dimensions in inches (millimeters)**

Indoor (Without Breakout Boot)		Outdoor/Indoor (Includes Breakout Boot)	
1/C Termination Indoor	MOD-3-TFT Kit	1/C Termination Outdoor	MOD-3-TFT Kit
<b>5/8 kV</b>			
TFT-50R	MOD-3Z-TFT*	TFT-50R	MOD-3C-TFT*
TFT-51R	MOD-3Z-TFT	TFT-51R	MOD-3C-TFT
TFT-52R	MOD-3Z-TFT	TFT-52R	MOD-3C-TFT
TFT-53R	MOD-3Z-TFT	TFT-53R	MOD-3D-TFT
TFT-150R-G	MOD-3Z-TFT*	TFT-150R-G	MOD-3C-TFT*
TFT-151R-G	MOD-3Z-TFT	TFT-151R-G	MOD-3C-TFT
TFT-152R-G	MOD-3Z-TFT	TFT-152R-G	MOD-3C-TFT
TFT-153R-G	MOD-3Z-TFT	TFT-153R-G	MOD-3D-TFT
<b>15 kV</b>			
TFT-150R-G	MOD-3Z-TFT*	TFT-151R-SG	MOD-3C-TFT*
TFT-151R-G	MOD-3Z-TFT	TFT-152R-SG	MOD-3C-TFT
TFT-152R-G	MOD-3Z-TFT	TFT-153R-SG	MOD-3D-TFT
TFT-153R-G	MOD-3Z-TFT	TFT-154R-SG	MOD-3D-TFT
<b>25 kV</b>			
TFT-251R-SG	MOD-3Z-TFT	TFT-251R-SG	MOD-3C-TFT
TFT-252R-SG	MOD-3Z-TFT	TFT-252R-SG	MOD-3C-TFT
TFT-253R-SG	MOD-3Z-TFT	TFT-253R-SG	MOD-3D-TFT
TFT-254R-SG	MOD-3Z-TFT*	TFT-254R-SG	MOD-3D-TFT*
<b>35 kV</b>			
TFT-352R-SG	MOD-3Z-TFT	TFT-352R-SG	MOD-3C-TFT
TFT-353R-SG	MOD-3Z-TFT	TFT-353R-SG	MOD-3D-TFT
TFT-354R-SG	MOD-3Z-TFT*	TFT-354R-SG	MOD-3D-TFT*

\* Refer to Selection information (#3) below this table.

Breakout Catalog Number	Insulation Diameter (Min.-Max.)	Jacket O.D. (Min.-Max.)	Components Jacketing	
			Tubes	Boot
MOD-3Z-TFT	0.60-1.72 (15-43)		3	0
MOD-3C-TFT	0.60-1.40 (15-35)	1.30-3.50 (33-89)	6	1
MOD-3D-TFT	1.20-1.72 (30-43)	2.70-4.50 (69-114)		

**Ordering Information**

1. Select three TFT single-conductor terminations.
2. To select the appropriate modification kit for the TFT terminations, use the MOD-3-TFT selection table above.
3. Use the MOD-3-TFT dimensions table to confirm the insulation and jacket diameters.
4. Related installation instructions: MOD-3-TFT.



C\_GelCap8

## GelCap 8 Motor Connection Kits 5-8 kV Shielded and Unshielded Cable

TE Connectivity's Raychem GelCap 8 stub connection kits provide quick installation, dependable performance, and easy reentry.

GelCap 8 stub connection kits insulate, seal, and protect stub splice connections up to 8 kV. The design was engineered to provide quick, secure installation and protection of the electrical connection from both physical and chemical attacks common in the harsh environment of motor connections.

Kits feature revolutionary PowerGel sealing gel which provides an excellent moisture seal over a wide temperature range (-40°C to 105°C). PowerGel sealing gel has excellent insulating properties and the added benefit of acting as a vibration damper.

The specially formulated material provides excellent abrasion resistance, insulation value, and UV resistance. The cap is designed to fit a wide range of cable sizes.

GelCap 8 stub connection kits provide the fastest installation. Simply place the gel filled insert between the cables and push the cover down over the connection. Secure with cable tie. No extra materials or grease are required. No trimming. The PowerGel sealing gel is already in the cap.

### Selection Information: dimensions in inches (millimeters)

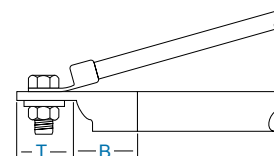

Catalog Number	Cap Length	Feeder Cable O.D.	Nominal Size	Lead Cable O.D.	Max. Length			
					Tang T	Barrel B	Bolt	
<b>GelCap-8-NS Non-Shielded Cable</b>								
GELCAP-8-NS-1V	8.5 (216)	0.47-0.84 (12-21)	4-250 kcmil	0.43-0.67 (11-17)	1.33 (34)	1.00 (25)	0.75 (19)	
GELCAP-8-NS-1VEX	11.5 (292)	0.47-0.84 (12-21)	4-250 kcmil	0.43-0.67 (11-17)	3.53 (90)	1.00 (25)	0.75 (19)	
GELCAP-8-NS-2V	12.5 (318)	0.84-1.10 (21-28)	250-500 kcmil	0.67-0.84 (17-21)	3.92 (100)	2.25 (57)	1.0 (25)	
<b>GelCap-8-S Shielded Cable</b>								
GELCAP-8-S-1V	8.5 (216)	0.67-1.00 (17-25)	4-2/0 AWG	0.40-0.62 (10-16)	1.33 (34)	1.00 (25)	0.75 (19)	
GELCAP-8-S-1VEX	11.5 (292)	0.67-1.00 (17-25)	4-2/0 AWG	0.40-0.62 (10-16)	3.64 (92)	1.00 (25)	0.75 (19)	
GELCAP-8-S-2V	12.5 (318)	1.00-1.35 (25-34)	4/0-500 kcmil	0.62-0.96 (16-24)	3.79 (96)	2.00 (51)	1.00 (25)	
		<b>Shield O.D. (Min.)</b>		<b>Jacket O.D. (Max.)</b>				
<b>Ground Kit* (Select Based on Shielded Cable Shield Diameter and Jacket Diameter Per Below)</b>								
GELCAP-8-GRD-1	.47 (12)			.70 (18)				
GELCAP-8-GRD-2	.67 (17)			1.35 (34)				

Kit contents - Each GELCAP-8-GRD kit contains the following: three each solder blocked ground braid, GelWrap sealing cover, roll spring, gel sealant strip, and six each copper tape strips and one installation instruction. If grounding is required at the motor box for shielded cable, a separate grounding kit may be purchased.

### Product Performance

AC Voltage withstand: 18 kV, 1 minute

DC Voltage withstand: 35 kV, 15 minutes

Impulse Withstand (BIL): minimum performance 75 kV, 10+, 10-

### Ordering Information

- Select appropriate catalog number based on the motor feeder cable and motor lead guidelines above. Selections are based on typical cable dimensions. Confirm selection with cable and connector dimensions.
- Packaging: Standard packaging is one kit per box. Each GelCap 8 kit contains components for a 3 phase motor connection which consists of three each of the following: elastomeric, gel filled cap; a gel filled cable insert; and cable tie. The type S kits for shielded cable also contain three each stress control pads.
- Kits do not contain connectors.
- Related tests reports: EDR-5408



C\_MCK-5

## Raychem MCK-5 Flame Retardant to 8.7 kV

### Type V

The Type V kit is designed to splice the stub or butt configuration that is commonly used where there is insufficient room to make in-line connections.

### Type L

The Type L kit is used, where space permits, to splice in-line connections. MCK is qualified to ANSI-C119.1 and rated to ICEA electrical withstand test for 1000 V.

- MCK-5 is rated to the general electrical requirements of the IEEE-48 withstand tests
- For use as an in-line or stub splice between 1/C poly feeder cable and motor leads
- Motor connection kit provides excellent insulation sealing—and resistance to abrasion—in motor connections

### Selection Information: dimensions in inches (millimeters)

Catalog Number	Motor Feeder Size AWG/kcmil	Bolt Length Max.	Connection Length Max.	Length Nominal
<b>Type V (Stub)</b>				<b>Cap</b>
MCK-5-1V	#8-#2	1.0	5.0 (127)	7.5 (191)
MCK-5-2V	#1-250	1.5	6.0 (152)	8.5 (216)
MCK-5-3V	300-750	1.5	7.0 (178)	9.5 (241)
<b>Type L (In-Line)</b>			<b>Sleeve</b>	
MCK-5-1L	#8-250	1.0	6.0 (152)	12.0 (305)
MCK-5-2L	300-1000	1.5	7.0 (178)	14.0 (356)

\*MCK (5/8.7 kV)

### Ordering Information

1. Select appropriate catalog number based on the motor feeder cable. MCK-5 selections are based on the typical dimensions of 100% insulated cables and the dimensions of commonly used connectors manufactured in accordance AEIC standard. Nominal insulation thickness (100%): 90 mils. For cables manufactured to other specifications, confirm selection with cable and connector dimensions.
2. Shielded cable must be terminated before installing MCK-5 (use TE Connectivity HVT-8x-G or HVT-Z-8x-G/SG. G only for HVT).
3. MCK-5 kits are designed for single-hole connectors and include caps and sealant strips for three connections. Kits do not contain connectors.
4. Standard package: MCK-5: 1 kit/box
- \*5. Related test reports: MCK-5: EDR-5010



C\_ELB\_15\_600

## ELB-15/28-600 Series 600/900 Amp 15/28 kV Class T-Body Elbow Connector

The Raychem ELB-15/28-600 and ELB-15/28-610 elbows are designed to terminate underground cables to high-voltage apparatus such as transformers and switchgear. They are fully shielded and fully submersible and meet the requirements of IEEE Standard 386. They are interchangeable with other manufacturers products that conform with this industry standard.

They are designed for use on extruded (XLPE or EPR) solid dielectric cable. The conductor range is from 1/0 AWG to 1250 kcmil for aluminum or copper conductors with insulation diameters from .640" to 1.965". The ELB-15/28-610 elbow has a capacitive test point molded into the elbow body which provides a means of sensing voltage and provides an attachment point for test point fault indicators. 900A ratings can be achieved by ordering the kit with a copper shearbolt terminal.

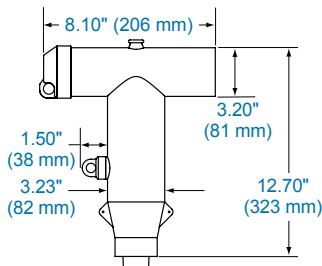

As an option, the elbow can also be ordered with TE's Aluminum or Copper ShearBolt Terminals. These are range taking mechanical connectors that will accommodate a conductor range from #2 compact to 1250 kcmil stranded, Class B.

The ShearBolt terminal design incorporates shear head bolts, which ensures that the correct torque is applied to each bolt and consequently the optimal contact force is generated to minimize connection resistance. Eliminating the need for crimp tooling and dies, they are therefore ideal when installation space is confined.

- Peroxide cured EPDM rubber ensures low tension set and high dielectric strength
- 100% factory production tested for partial discharge and AC Hipot per IEEE 386
- Optional capacitive test point provided on elbow
- Fits 15/28 kV cables up to 1250 kcmil
- Molded semiconducting shield provides ground shield continuity per the requirements of IEEE 592
- Meets IEEE 386-2006 specification requirements
- 900A capability is available

### ELB Kit Contents

Elbow, Insulating Plug\*, Cable Adapter, Stud\*, Connector\*, Silicone Lubricant, Installation Instruction, Jacket Seal (optional) \*When Copper ShearBolt is specified, kit will automatically include copper insulating plug and stud, therefore offering 900A capability.

### Ordering Information

1. To include a sealing kit, add "-ESA" suffix for heat-shrinkable and "-GES" suffix for cold applied Gelwrap ES closure.
2. If using copper tape cable, accessory ELB-35-600-GRDx (x = 1, 2, or 3) is required and ordered separately.
4. Related test reports:  
EDR-5482, EDR-5476,  
EDR-5502, EDR-5503.

### Selection Information

The part number for a 35 kV Elbow, 600 A with test point, an insulation OD of 1.755", and 750 kcmil stranded cable is ELB-35-610R750. (Or with AL ShearBolt ELB-15/28-610K-A3)



#### Current Rating/Test Point

600 = 600 AMP WITHOUT test point on T-Body  
610 = 600 AMP WITH test point on T-Body

#### Cable Insulation O.D. Range

Code	inches (mm)
A	.640-.760 (16.3-19.3)
B	.720-.845 (18.3-21.5)
C	.785-.970 (19.9-24.6)
D	.910-1.065 (23.1-27.1)
E	.980-1.140 (24.9-29.0)
F	1.080-1.280 (27.4-32.5)
G	1.220-1.420 (31.0-36.1)
H	1.360-1.560 (34.5-39.6)
J	1.480-1.700 (37.6-43.2)
K	1.640-1.840 (41.7-46.7)
L	1.780-1.965 (45.2-49.9)

#### Conductor Size (Aluminum or Copper)

Code	Str/Comp	Compact	Solid
1	1	1/0	1/0
2	2	2	2
10	1/0	2/0	2/0
20	2/0	3/0	3/0
30	3/0	4/0	4/0
40	4/0	250	—
250	250	300	—
300	300	350	—
350	350	400	—
400	400	450/500	—
450	450	500/550	—
500	500	600	—
550	550	650	—
600	600	700	—
650	650	750/800	—
750	700/750	900	—
800	800	900	—
900	900	1000	—
1000	1000	—	—
1100	1100	—	—
1250	1250	—	—

#### Aluminum ShearBolt | Conductor Size

Code	Compression, Compact, Strand
-A1	2-350
-A2	350-750
-A3	750-1000
-A4	1000-1250

#### Copper ShearBolt | Conductor Size

Code	Compression, Compact, Strand
-C1	2-4/0
-C2	4/0-500
-C3	500-750
-C4	750-1000
-C5	1000-1250



C\_ELB\_35\_600

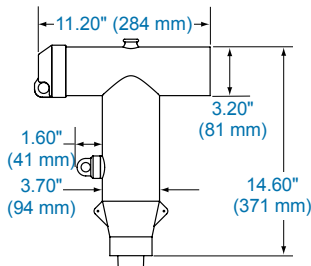

## ELB-35-600 Series 600/900 Amp 35 kV Class T-Body Elbow Connector

Raychem ELB-35-600 and ELB-35-610 elbows are designed to terminate underground cables to high-voltage apparatus such as transformers and switchgear. They are fully shielded and fully submersible and meet the requirements of IEEE Standard 386. They are interchangeable with other manufacturers products that conform with this industry standard.

They are designed for use on extruded (XLPE or EPR) solid dielectric cable. The conductor range is from 1/0 AWG to 1250 kcmil for aluminum or copper conductors with insulation diameters from .930" to 2.145". The ELB-35-610 elbow has a capacitive test point molded into the elbow body which provides a means of sensing voltage and provides an attachment point for test point fault indicators. 900A ratings can be achieved by ordering the kit with a copper shearbolt terminal.

As an option, the elbow can also be ordered with TE's new line of Aluminum or Copper ShearBolt Terminals. These are range taking mechanical connectors that will accommodate a conductor range from #2 compact to 1250 kcmil stranded, Class B.

The ShearBolt terminal design incorporates shear head bolts, which ensures that the correct torque is applied to each bolt and consequently the optimal contact force is generated to minimize connection resistance. Eliminating the need for crimp tooling and dies, they are therefore ideal when installation space is confined.

- Peroxide cured EPDM rubber ensures low tension set and high dielectric strength
- 100% factory production tested for partial discharge and AC Hipot per IEEE 386
- Optional capacitive test point provided on elbow
- Fits 35 kV cables up to 1250 kcmil
- Molded semiconducting shield provides ground shield continuity per the requirements of IEEE 592
- Meets IEEE 386-2006 specification requirements
- 900 A capability is available

### ELB Kit Contents

Elbow, Insulating Plug\*, Cable Adapter, Stud\*, Connector\*, Silicone Lubricant, Installation Instruction, Jacket Seal (optional) \*When Copper ShearBolt is specified, kit will automatically include copper insulating plug and stud, therefore offering 900A capability.

### Ordering Information

1. To include a sealing kit, add "-ESA" suffix for heat-shrinkable and "-GES" suffix for cold applied Gelwrap ES closure.
2. If using copper tape cable, accessory ELB-35-600-GRDx (x = 1, 2, or 3) is required and ordered separately.
3. Related test reports: EDR-5476, EDR-5482, EDR-5502, EDR-5503

### Selection Information

The part number for a 35 kV Elbow, 600 A with test point, an insulation OD of 1.755", and 750 kcmil stranded cable is ELB-35-610R750. (Or with AL Shearbolt ELB-15/28-610K-A3)



### Current Rating/Test Point

600 = 600 AMP WITHOUT test point on T-Body  
 610 = 600 AMP WITH test point on T-Body  
 Note: 600 AMP kit is provided with aluminum components.

### Cable Insulation O.D. Range

Code	inches (mm)
E	.930-1.040 (23.6-26.4)
F	.980-1.115 (24.9-28.3)
G	1.040-1.175 (26.4-29.8)
H	1.095-1.240 (27.8-31.5)
J	1.160-1.305 (29.5-33.1)
K	1.220-1.375 (31.0-34.9)
L	1.285-1.395 (32.6-35.4)
M	1.355-1.520 (34.4-39.0)
N	1.485-1.595 (37.7-40.5)
P	1.530-1.640 (38.9-41.7)
Q	1.575-1.685 (40.0-42.8)
R	1.665-1.785 (42.3-45.3)
S	1.775-1.875 (45.1-47.6)
T	1.845-1.965 (46.9-50.0)
U	1.935-2.055 (49.1-52.2)
V	2.025-2.145 (51.4-54.5)

### Conductor Size (Aluminum or Copper)

Code	Str/Comp	Compact	Solid
1	—	1/0	1/0
10	1/0	2/0	2/0
20	2/0	3/0	3/0
30	3/0	4/0	4/0
40	4/0	250	—
250	250	300	—
300	300	350	—
350	350	400	—
400	400	450/500	—
450	450	500/550	—
500	500	600	—
550	550	650	—
600	600	700	—
650	650	750/800	—
750	700/750	900	—
800	800	900	—
900	900	1000	—
1000	1000	—	—
1100	1100	—	—
1250	1250	—	—

### Aluminum ShearBolt | Conductor Size

Code	Compression, Compact, Strand
-A1	2-350
-A2	350-750
-A3	750-1000
-A4	1000-1250

### Copper ShearBolt | Conductor Size

Code	Compression, Compact, Strand
-C1	2-4/0
-C2	4/0-500
-C3	500-750
-C4	750-1000
-C5	1000-1250





C\_Deadbreak\_Standoff

## Deadbreak Standoff Plug 600 Amp 15 / 28-35 kV Class

Raychem 600A deadbreak standoff plug is available in both 15/28 kV and 35 kV Class versions. The standoff plug is meant for use in a parking stand of an apparatus or junction, where it provides insulated protection for energized 15/28-35 kV deadbreak interfaces.

They are frequently used temporarily or permanently within padmount cabinets, underground vaults, switchgear, transformers, and a variety of other apparatus. Typical applications include isolating and sectionalizing energized cable, system maintenance, circuit reconfiguration, and future expansion.

A fully shielded, submersible connection is offered, with conformance to IEEE Standard 386. These standoff plugs are therefore interchangeable with other manufacturers' products that also comply with this standard.

- 15/28 kV or 35 kV, 600A ratings
- Designed to be installed in the parking stand of apparatus
- Fully-shielded, fully submersible connection
- Stainless steel eyebolt with a stainless steel pressure foot
- Body bolted to stainless steel base bracket
- Compatible with 900A, all copper circuits
- Conforms to ANSI/IEEE standard 386

15/28 kV Deadbreak Standoff Plug

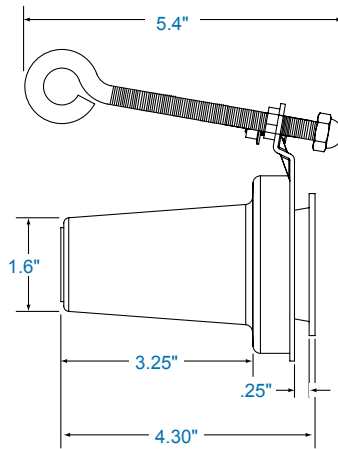

35 kV Deadbreak Standoff Plug

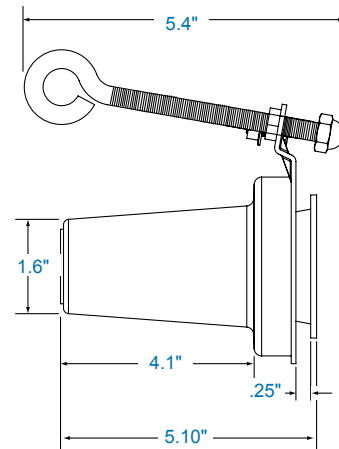

### Ratings

Voltage Class	15/28 kV	35 kV
Max. Rating Phase-to-Ground	16.2 kV	21.1 kV
Max. Rating Phase-to-Phase	28 kV	36.6 kV
AC 1 minute withstand	45 kV	50 kV
DC 15 minute withstand	88 kV	103 kV
BIL and full wave crest	140 kV	150 kV
Minimum Corona Level	21.5 kV (3pC)	26 kV (3pC)
Continuous	600A rms	600A rms
24 Hour Overload	1,000A rms	1,000A rms
Momentary:		
	25,000 A symmetrical 10 cycles	
	10,000 A symmetrical 3.00 sec	

### 100% Production Test

Minimum Corona level	21.5 kV (3pC)	26 kV (3pC)
AC 1 minute withstand	45 kV	50 kV

### Selection Information

Catalog Number	Voltage Class	Current Rating	Product Description
ELB-15/28-600-SP	15/28 kV	600	Aluminum Deadbreak Standoff Plug
ELB-35-600-SP	35 kV	600	Aluminum Deadbreak Standoff Plug

### Related test report

EDR-5510

## Deadbreak Insulating Cap 600 Amp 15/28 kV Class

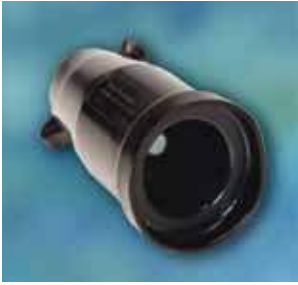

C\_Deadbreak\_Cap

Raychem 600A deadbreak insulating cap is available in 15/28 kV class. The insulating cap is meant to provide insulated protection for energized 15-28 kV deadbreak interfaces.

They are frequently used temporarily or permanently within padmount cabinets, underground vaults, switchgear, transformers, and a variety of other apparatus. Typical applications include system maintenance, circuit reconfiguration, and future expansion.

A fully shielded, submersible connection is offered, with conformance to IEEE Standard 386. These insulating caps are therefore interchangeable with other manufacturers' products that also comply with this standard.

- 15/28 kV, 600A ratings available
- Includes a semiconducting EPDM insert for stress relief
- High quality peroxide cured EPDM insulation
- Provides insulated, fully shielded, submersible connection
- Maintains ground potential on the cap's surface when the drain wire is connected to a common ground
- Compatible with 900A, all-copper circuits
- Conforms to ANSI/IEEE Standard 386

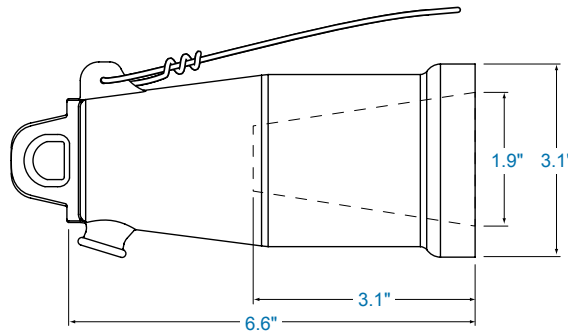

### Ratings

Voltage Class	15/28 kV
Max. Rating Phase-to-Ground	16.2 kV
Max. Rating Phase-to-Phase	28 kV
AC 1 minute withstand	45 kV
DC 15 minute withstand	88 kV
BIL and full wave crest	140 kV
Minimum Corona Level	21.5 kV (3pC)

### 100% Production Test

Minimum Corona level	21.5 kV (3pC)
AC 1 minute withstand	45 kV

### Selection Information

Catalog Number	Voltage Class	Current Rating	Product Description
ELB-15/28-600-IC	15/28 kV	600	Aluminum Deadbreak Insulating Cap



C\_Deadbreak\_Plug

## Deadbreak Connecting Plug 600/900 Amp 15/28-35 kV Class

Raychem 600/900A deadbreak connecting plug is available in both 15/28 kV and 35 kV class versions. The connecting plug is meant to connect two or more 600/900A deadbreak elbows. Typical applications are as a separable cable splice, circuit reconfiguration, or as an expandable, submersible junction.

900A ratings are achieved by ordering the copper version, but require copper cable and other copper constructed components.

A fully shielded, submersible connection is offered with conformance to IEEE Standard 386. These standoff plugs are therefore interchangeable with other manufacturers' products that also comply with this standard.

- 15/28 kV or 35 kV, 600 or 900A ratings available
- Fully submersible
- Industry standard 5/8"- 11 threaded stud used for electrical connection
- Available in either Aluminum or Copper
- Conforms to ANSI/IEEE Standard 386

### 15/28 kV Deadbreak Connecting Plug

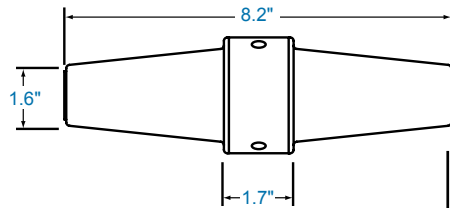

### 35 kV Deadbreak Connecting Plug

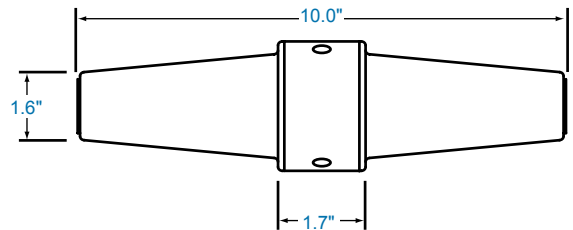

### Ratings

Voltage Class	15/28 kV	35 kV
Max. Rating Phase-to-Ground	16.2 kV	21.1 kV
Max. Rating Phase-to-Phase	28 kV	36.6 kV
AC 1 minute withstand	45 kV	50 kV
DC 15 minute withstand	88 kV	103 kV
BIL and full wave crest	140 kV	150 kV
Minimum Corona Level	21.5 kV (3pC)	26 kV (3pC)
Continuous	600/900A rms	600/900 A rms
24 Hour Overload	1,000A rms	1,000A rms
Momentary:		
600A	25,000 A symmetrical 10 cycles	
600A	10,000 A symmetrical 3.00 sec	
900A	40,000 A symmetrical 10 cycles	
900A	10,000 A symmetrical 3.00 sec	

### 100% Production Test

Minimum Corona level	21.5 kV (3pC)	26 kV (3pC)
AC 1 minute withstand	45 kV	50 kV

### Selection Information

Catalog Number	Voltage Class	Current Rating	Product Description
ELB-15/28-600-CP-AL	15/28 kV	600	Aluminum Deadbreak Connecting Plug
ELB-35-600-CP-AL	35 kV	600	Aluminum Deadbreak Connecting Plug
ELB-15/28-600-CP-CU	15/28 kV	600/900	Copper Deadbreak Connecting Plug
ELB-35-600-CP-CU	35 kV	600/900	Copper Deadbreak Connecting Plug

### Related test reports

EDR-5511



C\_Deadbreak\_Junction

## Deadbreak Junctions 600/900 Amp 15/28-35 kV Class

The Raychem 600A/900A deadbreak junction is available in both 15/28 kV and 35 kV Class versions. Deadbreak junctions are used with 600/900A elbows and accessories for connecting, establishing loops, tapping, and facilitating apparatus change out. They are commonly used in pad-mounted apparatus, sectionalizing cabinets, and underground vaults, where there is a critical use of space, flexibility, and operability.

The junction provides two, three, or four deadbreak interfaces bused together and encapsulated in a molded, peroxide-cured EPDM insulated rubber body, with an EPDM peroxide-cured semi-conductive outer shield. Optional stationary or adjustable mounting brackets are available, assembled with the junctions themselves. 900A ratings are achieved by ordering the copper version, but require copper cable and other copper constructed components. A fully shielded, submersible connection is offered, with conformance to IEEE Standard 386. These deadbreak junctions are therefore interchangeable with other manufacturers' products that also comply with this standard.

- Available in 2, 3, 4 point configurations
- Deadfront, 15/28 kV or 35 kV, 600 or 900A Ratings
- EPDM molded rubber construction
- Optional corrosion resistant stainless steel (adjustable or stationary) mounting brackets for direct wall mounting
- Maintenance free, fully shielded, submersible
- Applications include padmount, indoor/outdoor vault, subsurface
- Conforms to ANSI/IEEE Standard 386
- Heavy duty U-straps provide secure mounting for junctions

### Ratings

Voltage Class	15/28 kV	35 kV
Max. Rating Phase-to-Ground	16.2 kV	21.1 kV
Max. Rating Phase-to-Phase	28 kV	36.6 kV
AC 1 minute withstand	45 kV	50 kV
DC 15 minute withstand	88 kV	103 kV
BIL and full wave crest	140 kV	150 kV
Minimum Corona Level	21.5 kV (3pC)	26 kV (3pC)
Continuous	600/900A rms	600/900 A rms
24 Hour Overload	1,000A rms	1,000A rms
<b>Momentary:</b>		
600A	25,000 A symmetrical 10 cycles	
600A	10,000 A symmetrical 3.00 sec	
900A	40,000 A symmetrical 10 cycles	
900A	10,000 A symmetrical 3.00 sec	

### 100% Production Test

Minimum Corona level	21.5 kV (3pC)	26 kV (3pC)
AC 1 minute withstand	45 kV	50 kV

## Selection Information



Catalog Number	Current Rating	Size	Material
<b>Junction with U-Strap 15/28 kV</b>			
ELB-15/28-600-J2-AL	600A	J2	Aluminum
ELB-15/28-600-J3-AL	600A	J3	Aluminum
ELB-15/28-600-J4-AL	600A	J4	Aluminum
ELB-15/28-900-J2-CU	600/900A	J2	Copper
ELB-15/28-900-J3-CU	600/900A	J3	Copper
ELB-15/28-900-J4-CU	600/900A	J4	Copper

**Junction with U-Strap 35 kV**

ELB-35-600-J2-AL	600A	J2	Aluminum
ELB-35-600-J3-AL	600A	J3	Aluminum
ELB-35-600-J4-AL	600A	J4	Aluminum
ELB-35-900-J2-CU	600/900A	J2	Copper
ELB-35-900-J3-CU	600/900A	J3	Copper
ELB-35-900-J4-CU	600/900A	J4	Copper

**Junction with Stationary Bracket Included 15/28 kV**

ELB-15/28-600-J2-AL-STD	600A	J2	Aluminum
ELB-15/28-600-J3-AL-STD	600A	J3	Aluminum
ELB-15/28-600-J4-AL-STD	600A	J4	Aluminum
ELB-15/28-900-J2-CU-STD	600/900A	J2	Copper
ELB-15/28-900-J3-CU-STD	600/900A	J3	Copper
ELB-15/28-900-J4-CU-STD	600/900A	J4	Copper

**Junction with Stationary Bracket Included 35 kV**

ELB-35-600-J2-AL-STD	600A	J2	Aluminum
ELB-35-600-J3-AL-STD	600A	J3	Aluminum
ELB-35-600-J4-AL-STD	600A	J4	Aluminum
ELB-35-900-J2-CU-STD	600/900A	J2	Copper
ELB-35-900-J3-CU-STD	600/900A	J3	Copper
ELB-35-900-J4-CU-STD	600/900A	J4	Copper

**Junction with Adjustable Bracket Included 15/28 kV**

ELB-15/28-600-J2-AL-ADJ	600A	J2	Aluminum
ELB-15/28-600-J3-AL-ADJ	600A	J3	Aluminum
ELB-15/28-600-J4-AL-ADJ	600A	J4	Aluminum
ELB-15/28-900-J2-CU-ADJ	600/900A	J2	Copper
ELB-15/28-900-J3-CU-ADJ	600/900A	J3	Copper
ELB-15/28-900-J4-CU-ADJ	600/900A	J4	Copper

**Junction with Adjustable Bracket Included 35 kV**

ELB-35-600-J2-AL-ADJ	600A	J2	Aluminum
ELB-35-600-J3-AL-ADJ	600A	J3	Aluminum
ELB-35-600-J4-AL-ADJ	600A	J4	Aluminum
ELB-35-900-J2-CU-ADJ	600/900A	J2	Copper
ELB-35-900-J3-CU-ADJ	600/900A	J3	Copper
ELB-35-900-J4-CU-ADJ	600/900A	J4	Copper

**Related Test Report**

EDR-5508



C\_ELB\_15\_28\_600

## ELB-15/28-600 Elbow Modular Splicing Systems 600 Amp (15-35 kV) Class for Deadbreak T-body Elbow Connector

TE's Raychem Elbow Modular Splicing System offers separable solutions to fit a variety of needs which include: splicing, connecting to apparatus, dead-ending, and the ability to easily reconfigure circuits. At 15-35 kV 600 Amp, the following options are available: 2-way, 3-way, 4-way, or dead-end connections.

These kits use TE Connectivity's standard T-bodies, connecting plugs, insulating plugs, and conductive caps. They are fully shielded and fully submersible and meet the requirements of IEEE Standard 386. They are interchangeable with other manufacturers' products that conform with this industry standard.

- Peroxide cured EPDM rubber ensures low tension set and high dielectric strength
- 100% factory production tested for partial discharge and AC Hipot per IEEE 386
- Fits 15-35 kV cables up to 1250 kcmil
- Both compression lugs and range taking shearbolt connectors are available, along with the required cable adapter (sold separately)
- Designed for use on extruded (XLPE or EPR) solid dielectric cable

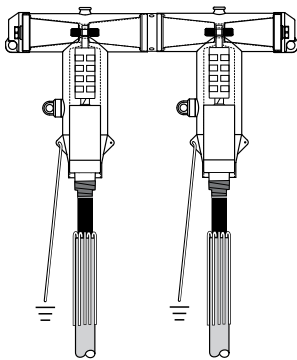

Kit Description	Assembly
ELB-15/28-600-T1WAY ELB-15/28-610-T1WAY ELB-35-600-T1WAY ELB-35-610-T1WAY	
ELB-15/28-600-T2WAY ELB-15/28-610-T2WAY ELB-35-600-T2WAY ELB-35-610-T2WAY	
ELB-15/28-600-T3WAY ELB-15/28-610-T3WAY ELB-35-600-T3WAY ELB-35-610-T3WAY	
ELB-15/28-600-T4WAY ELB-15/28-610-T4WAY ELB-35-600-T4WAY ELB-35-610-T4WAY	

Note: 600 version is without testpoint and 610 version is with test point.  
Modular Elbow Splice kits do not include connectors or cable adapters.

### Selection Information: dimensions in inches (millimeters)

Assembly	Approximate Width of Splicing System	
	15/28 kV	35 kV
Deadend (One Way)	10.1 (256)	12.1 (307)
Two Way	19.0 (483)	23.0 (584)
Three Way	27.9 (709)	33.9 (861)
Four Way	36.8 (935)	44.8 (1138)

### Ordering Information

1. Due to the variety of configurations possible, cable adapters and connectors are not included as part of this kit. Each one sold separately. Contact your local TE sales representative for assistance.
2. A spanner wrench (ELB-600-SPANNER, sold separately) may be required for proper installation.
3. If using copper tape cable, accessory ELB-35-600-GRDx (x = 1, 2 or 3) is required and ordered separately.
4. Sealing kits are available separately: the ESA for heatshrink, GES for cold-applied Gelwrap ES closure, and CES for cold-applied rip-cord style.
5. Related test reports: EDR-5482, EDR-5476, EDR-5502, EDR-5503, EDR-5511.



C\_ELB\_600\_ARST

## ELB-35-600 Arrester 600 A 35 kV T-Body Elbow Arrester

The Raychem ELB-35-600-ARSTR elbow arresters are designed to protect underground cables and high-voltage apparatus from voltage surges due to lightning and switching transients. They are fully submersible and meet the performance requirements of IEEE C62.11 and IEEE standard 386.

The 600A interface elbow arrester eliminates the need for bushing extenders, reducing tap plugs, and 200A load break interface arresters and installs in the same manner as a standard 35 kV 600 A elbow. The design incorporates an epoxy fiber module which integrates all MOV components in a single unit.

- The 600A interface bolts directly to a bushing, saving space and eliminating the need for adaptors.
- All MOV elements and end fittings are integrated in a single piece. There are no glued interfaces. The design is void and gap free ensuring peak performance under the harshest conditions.
- Tested in accordance with the dead front arrester failure mode test, which has proven TE's elbow arrester to have safe and predictable failure characteristics.
- Large diameter MOV elements provide high energy handling capability.

### ELB-35-600-ARSTR

#### Kit Contents:

- Elbow Arrester
- Insulating Plug (Al)
- Stud (Al)
- 36" tinned Cu Ground Lead
- Silicone Lubricant
- Installation Instruction

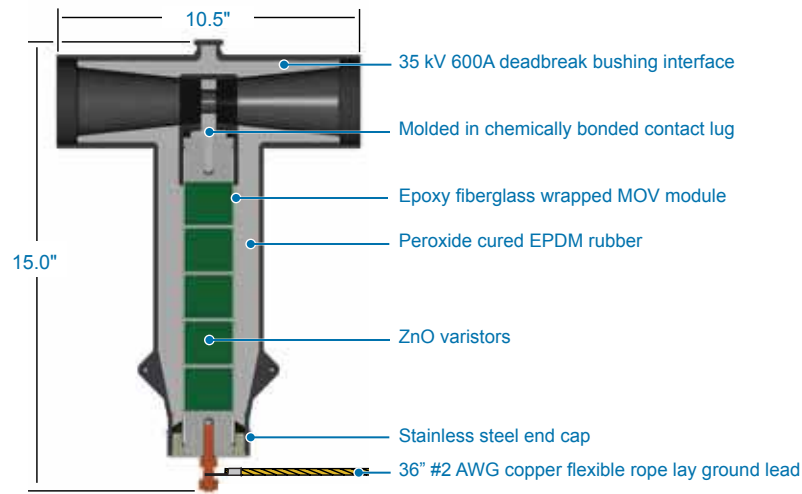

#### Selection Information: dimensions in inches (millimeters)

Catalog Number	Duty Cycle Rating (kV/rms)	MCOV (kVrms)	Maximum Discharge Voltage (kV crest)			
			8 x 20 microsecond current wave			
			1.5 kA	5 kA	10 kA	20 kA
ELB-35-600 ARSTR-27	27	22.0	65.6	72.3	78.2	85.7
ELB-35-600 ARSTR-30	30	24.4	72.6	79.9	86.5	94.8
ELB-35-600 ARSTR-33	33	26.8	80.1	88.2	95.4	104.5
ELB-35-600 ARSTR-36	36	29.0	87.1	95.9	103.8	113.8

#### Performance Characteristics

High Current Short Duration	65kA, 4 x 10µsec
Low Current Long Duration	75A, 2000µsec
Duty Cycle	5kA, 8 x 20µsec

Following each of the preceding tests the arrester demonstrates thermal recovery at MCOV.

- 100% Production Test
- Partial Discharge 26 kV (10pc)
- AC 1 minute withstand 50 kV (housing only)
- Reference Voltage Test



C\_ELB\_600\_CES

## Cold-Applied Elbow Seal CES 600 Amp (15-35 kV) Class for 1/C Jacketed Cables

TE Connectivity's Raychem CES Cold-Applied Elbow Sealing Kit is used for sealing power cables where elbows or other cable accessories are installed. The CES is applied in 15-35 kV, 600A applications. It protects underground cable from moisture and airborne contaminants, and is suitable for both direct burial and submersible applications.

The kit consists of a factory-expanded tubular EPDM rubber sleeve on a spiral holdout, along with strips of mastic which are used to help create the seal.

Designed for easy field installation. After applying the mastic and cable accessory, the spiral holdout is simply pulled clear. The jacket will compress and, in combination with the mastic, form an environmental seal.

- Highly elastic EPDM formulation enables wide cable application ranges. Just three products are able to cover the most common range of cable, 15 kV #2-35 kV 1250 kcmil
- An ergonomically designed spiral holdout provides a smooth installation with low release forces
- No open flame or heat source is required for installation
- Meets IEEE 404 jacket sealing requirements
- Thick walled tube resists puncture and damage
- Resistant to fungus, acids, and alkalis

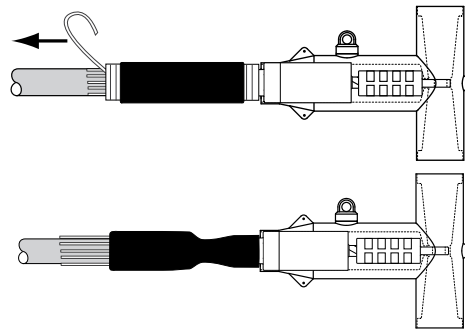

Typical Installation of ELB-600-CES

### Selection Information: dimensions in inches (millimeters)

Catalog Number	Typical Tube Length		Expanded Tube Diameter	Inner Diameter of Holdout	
	Expanded	Relaxed			
ELB-600-CES-1	5.00 (127)	6.00 (150)	2.24 (57)	2.09 (53)	
ELB-600-CES-2	6.75 (171)	8.00 (200)	2.95 (75)	2.75 (70)	
ELB-600-CES-3	7.50 (190)	9.00 (225)	4.13 (105)	3.85 (98)	

Catalog Number	Cable Size			Minimum Diameter	
	15 kV Class	25 kV Class	35 kV Class	Seal	Installed
ELB-600-CES-1	2-4/0 AWG (35-100 mm <sup>2</sup> )	2-2/0 AWG (35-50 mm <sup>2</sup> )	1/0 AWG (60 mm <sup>2</sup> )	0.95 (24)	1.94 (49)
ELB-600-CES-2	2/0-1000 kcmil (70-500 mm <sup>2</sup> )	1/0 AWG-750 kcmil (60-380 mm <sup>2</sup> )	1/0 AWG-500 kcmil (60-250 mm <sup>2</sup> )	1.28 (33)	2.67 (68)
ELB-600-CES-3	750-1500 kcmil (380-725 mm <sup>2</sup> )	600-1250 kcmil (325-625 mm <sup>2</sup> )	350-1250 kcmil (180-625 mm <sup>2</sup> )	1.60 (41)	3.50 (89)

### Ordering Information

1. Selections are based on the typical dimensions of 100% insulated cables, manufactured in accordance with AEIC standard. Nominal insulation thickness (100%): 15 kV: 175 mils, 25 kV: 260 mils, 35 kV: 345 mils.
2. Select the appropriate catalog number. Use the actual insulation OD, and jacket OD range as the final ordering criteria.
3. Kits used on metallic tape-shielded cables may require external grounding component. HVS-GC + HV-Braid.
4. For other applications or if you have any questions, contact your TE Connectivity representative.
5. If ordered separate from Elbow kits, standard package: 3 kits per box.
6. Related test reports: EDR-5528



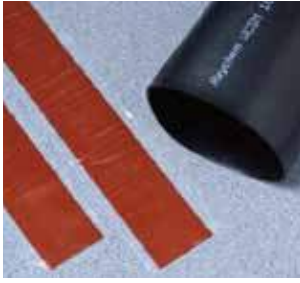

C\_ESA

## ESA

### Heat-Shrinkable Elbow Sealing Adapters for 1/C Jacketed URD and Shielded Power Cable

TE Connectivity's Raychem ESA elbow sealing adapters shrink down tightly to form an environmental re-jacketing seal.

- For use on jacketed concentric neutral, drain-wire-shielded, or copper-tape-shielded power cable
- Qualified to ANSI C119.1
- RUS accepted for termination/elbow sealing

Use this heat-shrinkable kit to seal the jacket of a power cable used with a premolded elbow.

#### Selection Information: dimensions in inches (millimeters)

Catalog Number	Conductor Size (AWG/kcmil)			
	5 kV	15 kV	25 kV	35 kV
ESA-1	#2-500	#2-250	#1-3/0	
ESA-2	600-1000	350-1000	4/0-1000	1/0-1000

#### Ordering Information

1. Select the appropriate catalog number based on the cable conductor size and voltage class. Selections are based on the typical dimensions of 100% or 133% insulated cables manufactured in accordance with AEIC standard. For cables manufactured to other specifications, selection should be confirmed with cable dimensions.
2. Kits used on metallic-tape-shielded cables may require an external grounding kit.
3. Standard package: 3 kits/box.
4. Related test report: EDR-5145.



C\_GelWrap\_ES

## GelWrap ES

### Wrap-Around Cold-Applied Elbow Sealing Adapter for 1/C Jacketed Cables

This kit is used to seal the jacket of a power cable used with a premolded elbow. The Raychem GelWrap ES elbow sealing closure kits are easily installed due to the wrap-around design. Simply install the elbow as you normally would then use the components of the GelWrap ES elbow sealing closure kit to provide an environmental seal. Pre-positioning of the sleeve is not required so retrofit installations are easily accomplished. One kit provides a very wide use range to minimize inventory requirements.

The sleeve is factory coated with PowerGel sealant to provide a positive moisture seal. PowerGel sealant strips are included in the kit to ensure proper sealing of any neutrals or grounds exiting the sleeve.

#### Selection Information: dimensions in inches (millimeters)

Catalog Number	Outside Diameter		Voltage Class	Insulated Conductor Size	
	Insulation Shield (Min.)	Cable Jacket or Covered Arm of Elbow (Max.)		100%	133%
GelWrap-ES-65/250150	1.00 (25)	2.40 (61)	5	500-1000	500-1000

#### Ordering Information

1. Select the appropriate catalog number based on the cable conductor size and voltage class. Selections are based on the typical dimensions of 100% or 133% insulated cables manufactured in accordance with AEIC standard. For cables manufactured to other specifications, selection should be confirmed with cable dimensions.
2. Kits used on metallic-tape-shielded cables may require an external grounding kit.
3. Standard package: 3 kits/box.
4. Related test report: EDR-5145.



C\_RVS\_SK

## RVS-SK Rayvolve “Roll-On” Elbow Sealing Adapters for Concentric Neutral Jackets for 1/C Jacketed URD Cable

TE Connectivity’s Raychem Rayvolve RVS-SK splice cover kits are the easy, “roll-on” way to seal JCN cable jackets when they are terminated to premolded elbows. RVS-SK splice cover kits provide an environmental seal that is maintained throughout exposure to conditions typical of elbow installations: temperature extremes (–36°F to 162°F/–20°C to 90°C), temperature cycling (41°F to 162°F/23°C to 90°C), and twisting and flexing motions as seen during switching.

- Qualified to ANSI C119.1
- For use on standard poly- or elastomeric-insulated cables
- Use to seal JCN cable jackets when terminated to pre-molded elbows

### Selection Information: dimensions in inches (millimeters)

Catalog Number	Outside Diameter		Voltage Class (kV)	Insulated Conductor Size (AWG/kcmil)	
	Insulation Shield (Min.)	Jacket O.D. (Max.)		100%	133%
RVS-13-SK	0.55 (14)	1.25 (32)	5	#2-250	#2-250
			15	#2-3/0	#2-1/0
			25	#1	
RVS-14-SK	0.70 (18)	1.60 (41)	5	3/0-600	3/0-600
			15	#2-400	#2-350
			25	#1-250	#1-3/0
			35	1/0-2/0	
RVS-15-SK*	1.15 (29)	2.00 (51)	5	600-1000	600-1000
			15	350-750	250-750
			25	4/0-600	1/0-500
			35	1/0-400	1/0-250

### Ordering Information

1. Select the appropriate catalog number. Selections are based on typical dimensions of low voltage insulated cable. Confirm selection with dimensions to assure proper sizing.
2. Kits do not contain connectors. The RVS-SK selection information covers all conductor types from solid to stranded.
3. Kits contain all materials necessary to seal from the cable jacket to either the cable semi-con or 200-A elbow.
- \*4. For warm weather installations (above 32°F), use range may be extended to a 2.25-inch-maximum jacket diameter. This covers 133%-insulated 1000-kcmil 15 kV and 25 kV cable, and 133%-insulated 750-kcmil 35 kV cable.
5. Kits used on metallic-tape-shielded cables may require an external grounding kits.
6. Each kit contains one Rayvolve RVS-SK sleeve and sealant strips.
7. Standard package: 6 kits/box
8. Related test report: EDR-5196



C\_JGK\_MS

## JGK-MS Jacketed Cable Grounding Kits (15-35 kV)

The Raychem JGK-MS kit addresses the RUS recommendation to externally ground the jacketed cable neutrals at least four times per mile to limit shield standing voltage, to avoid accidental shock, and to provide multiple parallel return paths for line-to-ground faults.

- Heat-shrinkable JGK-MS kits provide complete environmental sealing with a wraparound, adhesive-lined re-jacketing sleeve.
- Each kit contains a constant-force ground clamp, a solder-blocked ground braid for external grounding, and a sealant to encapsulate and seal the ground connector.
- Kits are RUS accepted and have been tested to meet the 10 kA/10 cycles or 15 kA/15 cycle fault current test requirements.
- Wraparound re-jacketing sleeve has been water-seal tested to the applicable sections of ANSI C 119.1.
- JGK-MS-HC kits have high fault current capability

### Selection Information: dimensions in inches (millimeters)

Catalog Number	Nominal Use Range (AWG/kcmil)			Rated Fault Current
	15 kV	25 kV	35 kV	
JGK-MS-1	#4-4/0	#1-1/0		10 kA, 10 cycles
JGK-MS-2	250-1000	1/0-750	1/0-500	15 kA, 15 cycles
JGK-MS-3	1000-2000	750-1750	500-1500	15 kA, 15 cycles
JGK-MS-HC-2	250-1000	1/0-750	1/0-500	30 kA, 10 cycles
JGK-MS-HC-3	1000-2000	750-1750	500-1500	30 kA, 10 cycles

### Ordering Information

1. Standard package: 3 kits/box
2. Related test report: EDR-5242

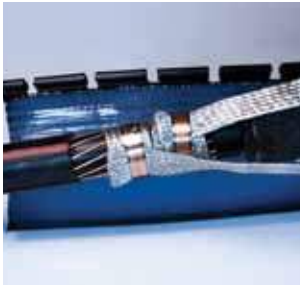

C\_GelWrap\_MS\_GRD

## GelWrap MS-GRD

### Cold-Applied Jacketed Concentric Neutral Cable Mid-Span Grounding Kit

The Raychem GelWrap MS-GRD kit addresses the WindFarm construction recommendation to externally ground jacketed concentric neutral power cable at least four times per mile to limit/minimize shield standing voltage, to avoid accidental shock, and to provide a return path for line-to-ground faults.

- Cold-Applied GelWrap MS-GRD kits provide complete environmental sealing with a Gel-Filled, wraparound re-jacketing sleeve.
- Each kit contains a constant-force ground clamp, a solder-blocked ground braid for external grounding, a gel sealant strip and tie wraps.
- Kits are tested to meet the 10 kA/10 cycles or 15 kA/15 cycle fault current test requirements.
- Wraparound re-jacketing sleeve has been water-seal tested to the applicable sections of ANSI C 119.1.

#### Selection Information: dimensions in inches (millimeters)

Check kit selection and fault current rating per Table 1.

Catalog Number	Outside Diameter		Voltage Class (kV)	Insulated Conductor Size	
	Shield O.D. (Min.)	Jacket O.D. (Max.)		100%	133%
GelWrap-MS-GRD-1	1.00 (25)	2.60 (61)	5	500-1000	500-1000
GelWrap-MS-GRD-2	1.00 (25)	2.60 (61)	5	500-1000	500-1000
GelWrap-MS-GRD-3	1.00 (25)	2.60 (61)	5	500-1000	500-1000

Catalog Number	Shield O.D. (Min.)	Jacket O.D. (Max.)	Nominal Use Range (AWG/kcmil)		
			15 kV	25 kV	35 kV
GelWrap-MS-GRD-CT-2	1.00 (25)	1.80 (46)	250-750	2/0-500	1/0-250

Table 1

Catalog Number	Nominal Use Range (AWG/kcmil)			Rated Fault Current
	15 kV	25 kV	35 kV	
GelWrap-MS-GRD-1	#4-2/0	#1	n/a	10 kA, 10 cycles
GelWrap-MS-GRD-2	2/0-750	#1-500	1/0-350	15 kA, 15 cycles
GelWrap-MS-GRD-3	1000-2000	750-1750	1500	15 kA, 15 cycles

#### Ordering Information

1. Select the appropriate catalog number based on the cable conductor size and voltage class. Selections are based on the typical dimensions of 100%- or 133%-insulated cables manufactured in accordance with the data contained in AEIC CS5. For cables manufactured to other specifications, selection should be confirmed with cable dimensions.
2. Kits used on metallic-tape-shielded cables may require external grounding components. See items HVS-GC and HV-Braid.
3. Standard package: 3 kits/box
4. Test report: EDR-5375



C\_HVE\_1590

### HVE-1590 Adapts 1/C PILC Cable for Installation of Elbow (15 kV)

TE Connectivity's Raychem HVE-1590 elbow adapters provide a highly effective and easily installed oil stop system, using standard heat-shrinkable components. The system provides an oil- and pressure-resistant seal.

- Oil barrier tubing locks the oil in the PILC cables, converting each conductor into the polymeric equivalent.
- Pressure rated to 15 psi at 90°C.
- Rated to the applicable requirements of ANSI-386.
- Converts PILC cable to allow installation of dead-break elbows.
- For use on 1/C PILC/VCLC cable.

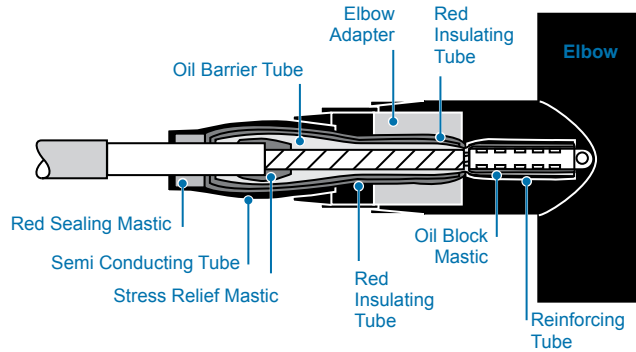

**Selection Information: dimensions in inches (millimeters)**

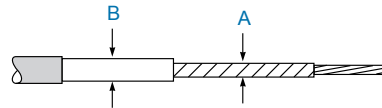

Catalog Number	1/C 15 kV* PILC Conductor Size (Nominal)	Insulation O.D.		Lead Sheath	Adapter Type Elastimold
		(Min.) A	(Max.) A	O.D. (Max.) B	
HVE-1591	#2 AWG-2/0	0.65 (16)	0.75 (19)	0.95 (24)	ELB-15/28-600-CA-F
HVE-1592	3/0-250 kcmil	0.75 (19)	0.95 (24)	1.10 (28)	ELB-15/28-600-CA-G
HVE-1593	300-500 kcmil	0.95 (24)	1.22 (31)	1.35 (34)	ELB-15/28-600-CA- H
HVE-1594	600-750** kcmil	1.22 (31)	1.35 (34)	1.50 (38)	ELB-15/28-600-CA-L

\*5 kV cables may be used provided the cable dimensions fall within the dimension ranges given above.

\*\*Compact strand only

Please Note: The TE Connectivity kit does not include the compression connector, cable adapter or elbow.

**Ordering Information**

1. Select the appropriate catalog number. All selections are based on the typical dimensions of 100% insulated cables manufactured in accordance with AEIC standard. Nominal insulation thickness (100%): 15 kV: 165 mils (PILC/VCLC).
2. For cables manufactured to other specifications, confirm selection with cable dimensions.
3. Standard package: One kit/box
4. Related test reports: 15 kV: EDR-5269.



# HIGH VOLTAGE CABLE ACCESSORIES & INSULATORS

## Splices, Terminations & Accessories

Torque Controlled Connectors and Lugs	190
EHVS Heat-Shrink Splices (46/69 kV)	192
EHVT Heat-Shrink Terminations (46/69 kV)	193
EHVS Three-Piece Splice (138 kV)	194
EHVS Single-Piece Splice (138/230 kV)	195
OHVT Oil-Filled Termination (69/138/230 kV)	196
OHVT Dry-Type Termination (138 kV)	196
PHVS/PHVT Dry Compact Switchgear and Transformer (69/138/230 kV)	197
Link Boxes	197

## Tools

Termination Lifting Device	198
EHVT-BRKT Mounting Brackets	198
EHVT-BP Mounting Base Plate	198
HVIA Cable Stripper	198
Cable Heating Blanket & Accessories	199
Tool Box	199

## High Voltage Insulators

Composite Station Post (Axicom)	200
---------------------------------	-----



C\_HV\_Torque

## High Voltage Torque Controlled Connectors and Lugs for Splices and Terminations up to 69 kV

The connector design allows cables to be spliced/terminated without special tools, heat treatment or filing after installation. Shearhead bolts ensure a pre-engineered electrical connection. The shearhead bolts break off at a predetermined level below the outer surface of the connector, at a defined torque. This ensures the correct contact pressure is reached every time. Oxide-breaking and corrosion prevention is performed by the contact grease inside the body.

- Fast and safe installation
- Excellent electrical performance
- Excellent mechanical performance
- Easy installation with socket wrench
- Pre-engineered design for perfect fit
- Cu and Al conductors
- Suitable for up to 1600 mm<sup>2</sup>
- Straight and size transition type connectors
- Body made of aluminum alloy
- Variety of different palms available
- Lug body made of tinned aluminum alloy

### Selection Information: dimensions in inches (millimeters)

#### Cable Lug with 1-hole Palm NEMA Pad (EPPA-071-x/y)

L = 6.54 in. (166.2 mm)

A = 3 in. (76.2 mm)

B = 1.5 in. (38.1 mm)

D = .56 in. (14.2 mm)

E = .98 in. (25 mm)

F = 2.68 in. (68 mm)

X, Y according to the cable dimensions

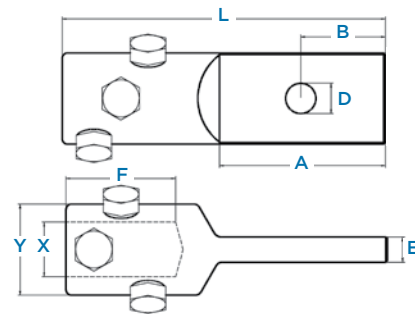

#### Cable Lug with 2-Hole Palm NEMA Pad (EPPA-072-x/y)

L = 6.54 in. (166.2 mm)

A = 3 in. (76.2 mm)

B = .63 in. (15.9 mm)

C = 1.75 in. (44.5 mm)

D = .56 in. (14.2 mm)

E = .98 in. (25 mm)

F = 2.68 in. (68 mm)

X, Y according to the cable dimensions

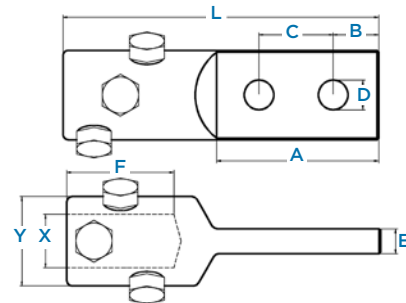

#### Cable Lug with Rod

##### ROD $\varnothing$ 30 mm (EPPA-050-X/Y)

L = 7.48 in. (190 mm)

A = 3.94 in. (100 mm)

F = 2.52 in. (64 mm)

$\varnothing$  = 1.18 in. (30 mm)

##### ROD $\varnothing$ 40 mm (EPPA-053-X/Y)

L = 10.39 in. (264 mm)

A = 4.92 in. (125 mm)

F = 4.02 in. (102 mm)

$\varnothing$  = 1.57 in. (40 mm)

##### ROD $\varnothing$ 50 mm (EPPA-061-X/Y)

L = 10.39 in. (264 mm)

A = 4.92 in. (125 mm)

F = 4.19 in. (106.5 mm)

$\varnothing$  = 1.97 in. (50 mm)

X, Y according to the cable dimensions

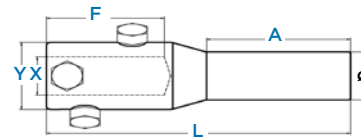



## Splices, Terminations & Accessories

### Cable Lug with 4-Hole Palm NEMA Pad (EPPA-054-X/Y)

Contact plate: EPPA-054-X/Y

4 in. x 4 in. (101.6 mm x 101.6 mm)

L = 9.2 in. (234 mm)

A = 4 in. (101.6 mm)

B = 1.13 in. (28.6 mm)

E = .98 in. (25 mm)

C = 1.75 in. (44.5 mm)

D = .56 in. (14.3 mm)

F = 4.53 in. (115 mm)

Contact plate: EPPA-054-X/Y-A

3 in. x 3 in. (76.2 mm x 76.2 mm)

L = 8.2 in. (208.3 mm)

A = 3 in. (76.2 mm)

B = .63 in. (15.9 mm)

E = .98 in. (25 mm)

C = 1.75 in. (44.5 mm)

D = .56 in. (14.3 mm)

F = 4.53 in. (115 mm)

X, Y according to the cable dimensions

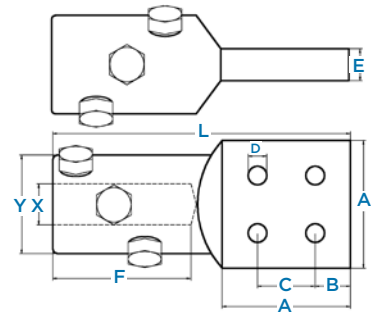

### Cable Lug with 6-Hole Palm NEMA Pad (EPPA-076-X/Y)

Contact plate: 4 in. x 6 in. (101.6 mm x 152.4 mm)

L = 11.2 in. (285 mm)

W = 4 in. (101.6 mm)

B = 1.25 in. (31.8 mm)

E = .98 in. (25 mm)

C = 1.75 in. (44.5 mm)

D = .56 in. (14.3 mm)

F = 4.53 in. (115 mm)

A = 6 in. (152.4 mm)

X, Y according to the cable dimensions

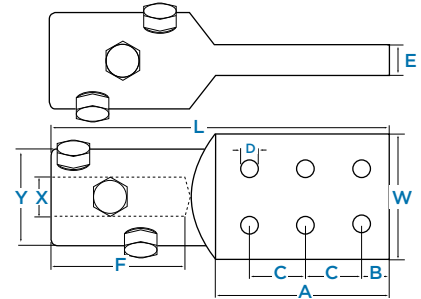

### Mechanical Connector for Straight Connection (EPPA-047-X/Y-L)

L = 5.12 in. (130 mm)

L = 7.09 in. (180 mm)

X, Y according to the cable dimensions

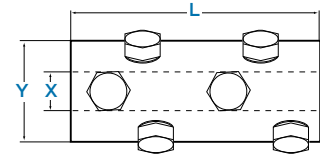

### Mechanical Connector for Size Transition (EPPA-047-X1/Y1-X2/Y2-L)

L = 5.12 in. (130 mm)

L = 7.09 in. (180 mm)

X1/Y1, X2/Y2 according to the cable dimensions

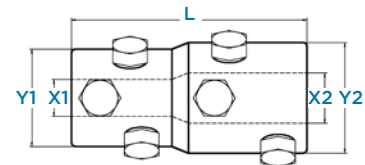

### Mechanical Connector for Cables with Small Insulation Thickness (EPPA-063-X1/Y1-X2/Y2-L)

L = 7.09 in. (180 mm)

L = 9.06 in. (230 mm)

X1/Y1, X2/Y2 according to the cable dimensions

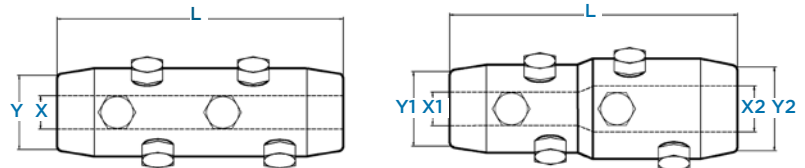



C\_EHVS

## EHVS Splices for 1/C Shielded Cable (46 and 69 kV)

A complete line of Raychem splice kits for conductor sizes ranging from 4/0-2500 kcmil.

TE sizes the EHVS splice to your application. You simply fill out an EHVS information sheet (available from your TE representative). Based on the information you provide (conductor, insulation, and jacket diameters), we will machine a connector to fit your cable and supply you with a kit containing both the connector and the EHVS splice for your cable.

- 69 kV splice incorporates a connector that allows large cross sections to be joined without special tools, heat treatment, or filing off after installation, thus reducing outage time.
- For use on wire shield, wire metallic tape shield, and metallic sheathed power cables.
- Minimum installation space required is 84.0".

### Selection Information: dimensions in inches (millimeters)

Catalog Number	69 kV	46 kV	Jacket O.D. (Max.)	Insulation Diameter Range
	Nominal Cable Range	Nominal Cable Range		
EHVS-6920-W-CXXX	1/0-3.0 AWG	250-500 kcmil	2.00 (61)	1.35-1.75 (34-44)
EHVS-6921-W-CXXX	2/0-500 kcmil	600-1000 kcmil	2.85 (72)	1.70-2.35 (43-60)
EVHS-6922-W-CXXX	600-1000 kcmil	1250-2000 kcmil	3.00 (76)	2.05-2.55 (52-55)
EVHS-6923-W-CXXX	1250-2500 kcmil	2500 kcmil	3.85 (98)	2.50-3.05 (63-77)

### Ordering Information

1. Contact your local TE representative for the appropriate part number to order. To help us supply the correct product; the following information is required: conductor, insulation, and jacket diameters.
2. Each splice comes supplied with a shear bolt connector manufactured to your cable dimensions.
3. Related test report: 46/69 kV: PPR 1010, EDR-5228



C\_EHVT\_GHVT

## EHVT

### Termination for 1/C Shielded Power Cable (46 and 69 kV)

TE's Raychem EHVT series high-voltage terminations utilize a stress control system that has been field-proven for more than 20 years.

#### Reduced Installation Costs

Because the 46 and 69 kV HVT kits use standard heat-shrink components, guide tubes are not needed for alignment, elastomer compression, computed venting, or field compound filling. Only standard cable support systems are needed, reducing steel structure or pole top support requirements.

#### Superior High-Contamination Withstand and Non-Tracking

The unique high-voltage insulating sleeve is a field-proven, nontracking, and erosion-resistant material that does not require periodic cleaning. The material properties have been formulated to be thermally stable and highly resistant to UV degradation, weathering, and environmental pollution.

#### Positive Environmental Seal

The cable, along with external ground, is sealed from moisture ingress using TE's proven high-voltage, heat-activated scaling system. No field engineering or additional accessory kits are required.

Rated to IEEE-48, class 1, for outdoor (weather-exposed) use. For use on wire shield, wire/metallic-tape shield, lead sheath, and jacketed concentric neutral cables. Both kits contain a limited number of lightweight components with unlimited shelf life under normal storage conditions.

#### Selection Information: dimensions in inches (millimeters)

Catalog Number		Conductor Size (AWG/kcmil)	Insulation Diameter (Min.-Max.)	Jacket O.D. (Max.)
Indoor	Outdoor			
<b>46 kV 32"</b>				
	<b>40"</b>			
EHVT-462-G	EHVT-462-SG	#2-4/0	1.18-1.77 (30-45)	2.36 (60)
EHVT-463-G	EHVT-463-SG	250-750	1.47-2.05 (38-52)	2.75 (70)
EHVT-464-G	EHVT-464-SG	1000-1500	1.97-2.56 (50-65)	3.35 (85)
EHVT-465-G	EHVT-465-SG	1750-2500	2.48-3.03 (63-77)	3.94 (100)
<b>69 kV 42"</b>				
	<b>52"</b>			
EHVT-691-G	EHVT-691-SG	1/0-350	1.50-2.05 (38-52)	2.65 (67)
EHVT-692-G	EHVT-692-SG	350-1000	1.95-2.55 (50-65)	3.25 (83)
EHVT-693-G	EHVT-693-SG	1000-2000	2.50-3.05 (64-77)	3.95 (100)

#### Ordering Information

1. Select the appropriate catalog number. Selections are based on the typical dimensions of 100% insulated cables and the dimensions of commonly used connectors manufactured in accordance with AEIC standard. Nominal insulation thickness (100%): 46 kV: 420 mils, 69 kV: 650 mils.
2. For cables manufactured to other specifications, confirm selection with cable dimensions.
3. Kits do not contain connectors; order connectors separately.
4. Installed length: 46 kV: Indoor (-G): 32 (813), Outdoor (-SG): 40 (1016)  
Installed Length 69 kV: Indoor (-G): 42 (1067), Outdoor (-SG): 52 (1321)
5. Related test report: 46 kV: PPR-1085, 69 kV: EDR-5241
6. EHVT-BRKT available to accommodate cable diameters from 2.5-4.5 inches (65-115 mm).
7. EHVT-BP base plates for mounting the EHVT-BRKTs are also available.



C\_3pcJoint

## EHVS-T Three-Piece Splice up to 138 kV

TE's Raychem splice is a pre-fabricated three piece design for voltage classes up to 138 kV. Polymeric insulated cables of various designs can be adapted with respect to shielding and metal sheath. The silicone rubber joint parts with integrated geometrical stress control provides proven electrical function. The splice components combine electrical performance, stress control and moisture sealing to provide the important functions required for all high voltage products.

- Torque-controlled connector
- Splice fits on all polymeric cable constructions
- Proven shield continuity concept
- Special silicone rubber provides perfect compression force for optimized electrical performance
- Short cut-back dimensions
- No special tools required to install the splice
- Cable size transition possible
- No tension set of splice body
- Moulded outer conductive screen
- Geometrical electrical stress control by moulded conductive deflectors
- Type tested according to IEC60840 and IEEE404 Standards
- Manufactured according to ISO9001 and ISO14001

### Technical Data

**138 kV**

Rated voltage U <sub>0</sub> /U (Um)	kV	76/132 (145)
Basic impulse level	kV	650
Max. continuous operating temperature	°C	90
Max. conductor emergency temperature	°C	150
Conductor short circuit temperature	°C	250
Short circuit current (sheath)	kA / 1sec	40

### For Shield Break Joints

DC voltage between metallic sheaths/screens	kV	20
DC voltage between metallic sheath/screen and earthed exterior	kV	20
Lightning impulse voltage between metallic sheath/screen	kV	75
Lightning impulse voltage between metallic sheath/screen and earthed exterior	kV	37.5

### Application Range

Conductor	kcmil	2250
Diameter over Insulation	inch (mm)	1.69-3.31 (43-84)

For special applications and bigger cable sizes please contact your TE representative.



C\_1pcJoint

## EHVS-S One-Piece Splice up to 230 kV

TE's Raychem splice is a pre-fabricated one-piece design for voltage classes up to 230 kV. Polymeric insulated cables of various designs can be adapted with respect to shielding and metal sheath. The silicone rubber joint body with integrated geometrical stress control provides proven electrical function. The splice components combine electrical performance, stress control and moisture sealing to provide the important functions required for all High Voltage products.

- Premoulded one-piece joint body
- Torque-controlled connector
- Choice of outer sealing and protection systems
- Splice fits on all polymeric cable constructions
- Proven shield continuity concept
- Special silicone rubber provides perfect compression force for optimized electrical performance
- Simple assembly
- No tension set of joint body
- Moulded thick outer conductive screen
- Geometrical electrical stress control by moulded conductive deflectors
- Type tested according to IEC60840, IEC 62067, IEEE404, GB11017 Standards
- Manufactured according to ISO9001 and ISO14001

<b>Technical data</b>		<b>138 kV</b>	<b>230 kV</b>
Rated voltage U0/U (Um)	kV	76/132 (145)	127/220 (245)
Basic impulse level	kV	650	1050
Max. continuous operating temperature	°C	90	90
Max. conductor emergency temperature	°C	150	150
Conductor short circuit temperature	°C	250	250
Short circuit current (sheath)	kA / 1sec	40	40

### Application range

Conductor	kcmil	2250	5000
Diameter over Insulation	inch (mm)	2.20-3.07 (56-78)	2.80-4.69 (71-119)

For special applications and bigger cable sizes please contact your TE Connectivity representative.



C\_OHVT

## OHVT Oil-Filled Outdoor Termination up to 230 kV

The Raychem OHVT high voltage outdoor termination system is designed for voltage up to 230 kV and to operate under severe environmental conditions. Polymeric insulated cables of various designs can be adopted with respect to shielding and metal sheath. Composite or porcelain housings with different creepage lengths are available covering the most common and also extreme pollution levels. The installation of the termination can be done by trained installer equipped with conventional tools.

The termination is designed according to following standards: IEC-60840, IEC-62067, IEC-60815, IEEE-48, IEEE-1313.

Technical Data		69 kV	138 kV	170 kV	230 kV
Rated voltage $U_v/U_m$	kV	36/69 (72.5)	76/132 (145)	87/161 (170)	127/220 (245)
Basic impulse level	kV	325	650	750	1050
Max. continuous operating temperature	°C	90	90	90	90
Max. conductor emergency temperature	°C	150	150	150	150
Conductor short circuit temperature	°C	250	250	250	250
Short circuit current (sheath)	kA / 1sec	40	40	40	40
Creepage (Pollution class IEC 60815)		a-e	a-e	a-e	a-e
Withstand voltage support insulators (AC/DC)	kV	10/20	10/20	10/20	10/20

### Application Range

Conductor	kcml	3750	3750	5000	5000
Diameter over Insulation: Composite	inch (mm)	1.34-3.82 (34-97)	1.34-3.82 (34-97)	1.34-4.25 (34-108)	2.80-4.69 (71-119)
	Porcelain	inch (mm)	1.34-2.91 (34-74)	1.34-2.91 (34-74)	—
Diameter over sheath	inch (mm)	4.33 (110)	4.33 (110)	4.69 (119)	6.30 (160)

All listed dimensions are standard size to serve the common application of these terminations.

For special applications and bigger cable sizes please contact your TE representative.



C\_OHVT\_D

## OHVT-D Dry Self-Supporting Outdoor Termination up to 138 kV

The dry self-supporting termination is designed for voltage class 138 kV and operation under severe environmental conditions. It is free from any insulating liquid or gel. Polymeric insulated cables of various designs can be adopted with respect to shielding and metal sheath. The polymeric housing with long creepage length covers extreme pollution levels according to IEC 60071-1 1996, IEC 60071-2 1996 and IEEE-1313.1-1996. Its mechanical performance is similar to conventional oil-filled terminations with composite housing. The termination is easily separable and consists of a plug-in part and an epoxy resin insulator protected with a directly moulded silicone shed housing.

Due to the short cable cut-back dimensions of the plug-in, the time required to install the termination is very short and can be further reduced in case of short cable links by pre-installing the plug-in on the shop floor. The plug-in is similar to the plug-in used with our dry switchgear/transformer termination.

- Dry interface, no oil-filling
- Self-supporting
- Pre-fabricated and factory tested silicone-rubber stress cone
- Torque-controlled multi-contact conductor bolt
- Fast and simple installation combining GIS plug-in technology with polymeric insulators
- No special tools required to install the termination
- Isolated cable gland for sectionalization
- Long creepage length
- Type tested according to IEC 60840



C\_PHSV\_PHVT

## Raychem PHVS/PHVT Dry Compact Switchgear and Transformer Termination

up to 230 kV

The dry compact switchgear termination for voltage classes up to 230 kV is designed to be installed in cable entry housings of gas-insulated switchgear (GIS). It complies with IEC 62271-209 standard, which essentially specifies the interfaces between the termination and the switchgear. Therefore the termination will fit into all GIS complying with IEC 62271-209. Adapters are available to match the dimensions of wet (oil-filled) type terminations, and older designs specified in IEC 60859. The termination operates in SF<sub>6</sub> but also in insulating liquids like transformer oil. A corona shield at the top of the termination then provides the necessary shielding of the terminal.

The termination is easily separable and consists of a plug-in part and an epoxy resin insulator. The insulator can be installed by the GIS or transformer manufacturer already at the factory saving installation time on-site and reducing the risk of contamination of the cable entry housing. In case of short cable links and due to the short length and light weight of the plug-in part it can be also pre-installed by the cable manufacturer further reducing the time required to install a substation.

- Dry interfaces, no oil-filling
- Dimensions comply with pressure-tight resin housing
- Operates in SF<sub>6</sub> and insulating liquids
- Pre-fabricated and factory tested Si-rubber stress cone
- Torque-controlled multi-contact conductor bolt
- No special tools required to install the termination
- Isolated cable gland for sectionalization
- Type tested according to IEC 60840, IEC 62067 and IEC 62271-209 standards



C\_LINK\_BOXES

## Link Boxes

### Cross Bonding and Sectionalization for High-Voltage Cable Systems

Link boxes are used with cable joints and terminations to provide easy access to shield breaks for test purposes and to limit voltage build-up on the sheath. Lightning, fault currents and switching operations can cause overvoltages on the cable sheath. The link box optimizes loss management in the cable shield on cables grounding both sides.

- Can be installed in pits or vaults and on structures or poles
- Use with single core or concentric bonding lead
- Cross section up to 250 kcmil
- Direct grounding
- Single point bonding
- Cross bonding and transposition
- Sheath voltage limiters (SVL)
- Tested to ANSI/IEEE Std. 575. Guide for the application of sheath-bonding methods for single conductor cables and the calculation of induced voltages and currents in cable sheaths.
- CIGRE/ELECTRA recommendations for cross bonding (Larger cable cross sections on request)

#### Selection Information: dimensions in inches (millimeters)

Catalog Number		Number of Phases	Sheath Voltage Limiter	Dimensions		
				L	W	H
EPPA-055-0/1	Direct grounding	1	---	11.81 (300)	7.48 (190)	6.50 (165)
EPPA-055-3/1	Cross bonding	1	3 kV	11.81 (300)	7.48 (190)	6.50 (165)
EPPA-055-6/1	Cross bonding	1	6 kV	11.81 (300)	7.48 (190)	6.50 (165)
EPPA-055-0/3	Direct grounding	3	---	12.20 (310)	12.20 (310)	10.04 (255)
EPPA-055-3/3	Cross bonding	3	3 kV	12.20 (310)	12.20 (310)	10.04 (255)
EPPA-055-6/3	Cross bonding	3	6 kV	12.20 (310)	12.20 (310)	10.04 (255)

#### Product Information

Test Reports: PPR 1168 Type Test of Link Box LBOX3-ZnO-3  
PPR 1449 Type Test of Link Box EPPA-055-6/3



C\_SHVT\_THVT

## Lifting Device for High Voltage Outdoor Termination up to 138 kV

The Lifting Device ensures a safe and easy installation of TE Connectivity outdoor terminations on high positioned mounting places. The installer can do the complete installation of the termination on the ground including the oil filling and then lifting up the termination to the high positioned mounting place. Mounting the termination onto the rack is the only work step the installer has to do on the pylon.

- Simplifies placement and mounting onto the rack on the pylon
- Applicable for all TE terminations up to 138 kV
- Adjustable to all common cable sizes up to a diameter over cable sheath of 110 mm
- Easy assembly and handling

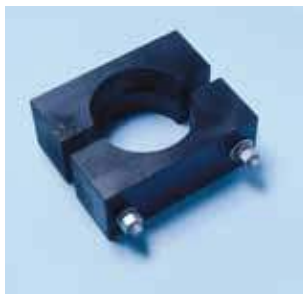

C\_EHVT\_BRKT

## EHVT-BRKT

EHVT-BRKT high voltage cable mounting brackets are made from a high density UV resistant black polymer and are designed to support larger diameter cables. The brackets will be bolted to appropriate supporting steel work or cross-arms, using the galvanized steel fixing hardware, including two seven inch long bolts, with nuts and washers to suit. Supporting steelwork will need two holes drilled with centers five and one half inches apart to accept the "nuts, bolts and washers". Seven sizes accommodate cable diameters from 1.75" thru 4.25".

### Selection Information: dimensions in inches (millimeters)

Catalog Number	Min. Cable O.D.
EHVT-BRKT-2.00IN	1.75-2.00 (44-51)
EHVT-BRKT-2.25IN	2.00-2.25 (51-57)
EHVT-BRKT-2.50IN	2.25-2.50 (57-63)
EHVT-BRKT-2.75IN	2.50-2.75 (63-70)
EHVT-BRKT-3.00IN	2.75-3.00 (70-76)
EHVT-BRKT-3.50IN	3.25-3.50 (83-89)
EHVT-BRKT-3.75IN	3.50-3.75 (89-95)
EHVT-BRKT-4.00IN	3.75-4.00 (95-102)
EHVT-BRKT-4.25IN	4.00-4.25 (102-108)

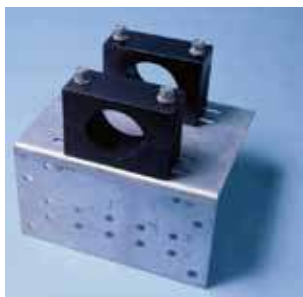

C\_EHVT\_BP

## EHVT-BP High Voltage Cable Mounting Base Plate

The base plate is a galvanized steel plate intended for use with TE heat-shrink EHVT/GHVT terminations together with EHVT-BRKT support brackets. The plate comes suitably drilled for attaching to supporting steelwork or cross arms that have been drilled to accept steelwork for various porcelain insulator type terminations. It is especially useful when retrofitting old porcelain termination with heat-shrink terminations. It has suitable spaced slots to accommodate two EHVT-BRKTs.

### Selection Information

Catalog Number	Std. Pack
EHVT-BP	1 base plate per box



C\_HVIAstripper

### HVIA-Stripper 35/90-US

Stripping tool for cable semicon and primary insulation for cable diameters from 1.37"-3.54" (35-90 mm)

### HVIA-Stripper 75/150-US

Stripping tool for cable semicon and primary insulation for cable diameters from 2.95"-5.90" (75-150 mm)





## High Voltage Heating Blanket and Slide Rails with Clamps

### HVIA-CABLE-HEATING-BLANKET

Cable heating blankets



### Screw Clamps (accessory to Heating Blanket)



### HVIA-SLIDE-RAIL-1580

Slide rail

C\_Blanket

## Tool Box



C\_ToolBox

- |     |                                   |    |  |
|-----|-----------------------------------|----|--|
| 1   | Power saw                         | 1  | Screw clamp 100mm                      |
| 1   | Large cable cutter                | 6  | Screw clamp 120mm                      |
| 2   | Long slide rails*                 | 1  | Hand saw                               |
| 6   | Short slide rails*                | 20 | White marker                           |
| 1   | Hook knife                        | 2  | Eye bolt M10 / M12 / M16               |
| 1   | Mechanical compression tool       | 1  | Abrasive block                         |
| 1   | Stripping tool*                   | 1  | Socket wrench 7mm/8mm                  |
| 1   | Pipe cutter                       | 1  | Tubular box spanner 19x22              |
| 1   | Cable sheath cutter*              | 1  | Wire brush                             |
| 2   | Cable heating blankets*           | 1  | Rethreading die M8/M10/M12/M16         |
| 1   | Small cable cutter                | 1  | Hand thread-cutting tap M8/M10/M12/M16 |
| 10  | Cable knives*                     | 1  | Double open-end spanner-set            |
| 1   | Shrinkage burner*                 | 1  | Allen key set                          |
| 1   | Small orbital sander              | 1  | Wrecking bar                           |
| 100 | Abrasive pads P180/P240/P320/P400 | 1  | Rasp                                   |
| 1   | Large orbital sander              | 1  | Stud bolt driver-set                   |
| 100 | Abrasive pads P180/P240/P320/P400 | 2  | Plastic hammers                        |
| 1   | Rechargeable power drill          | 1  | Heavy cutting plier                    |
| 1   | Hammer drill                      | 1  | Adjustable spanner                     |
| 1   | Drill bit set 1-10mm              | 1  | Screw extractor set                    |
| 1   | Drill 10.5mm HSS/E                | 1  | Flashlight                             |
| 1   | Drill 13mm HSS/E                  | 10 | Plastic folding rulers                 |
| 2   | Floodlights                       | 1  | Digital caliper                        |
| 2   | Extension cables 230V             | 1  | Caliper                                |
| 1   | Side-cutting plier                | 1  | Try square                             |
| 1   | Combination plier                 | 1  | Spirit level                           |
| 1   | Hammer 500g                       | 1  | Plastic tarpaulin                      |
| 1   | Hammer 1000g                      | 1  | Paper cleaning tissue                  |
| 1   | Torque wrench                     | 1  | Stretch foil                           |
| 1   | File assortment                   | 50 | Latex gloves                           |
| 1   | Adjustable tap wrench             | 1  | Chain hoist                            |
| 1   | Allen wrench socket               | 2  | Chain blocks                           |
| 1   | Socket set 1/4                    | 3  | Lifting straps                         |
| 1   | Socket set 1/2                    | 2  | Round slings                           |
| 1   | Chisel and punch set              | 4  | Ratchet lashing straps                 |
| 1   | Double-end ring spanner set       |    |  |
| 2   | Screwdriver set                   |    |  |
| 2   | Multigrip pliers                  |    |  |

\*Tools can be ordered separately.



C\_Composite\_SPost

## Composite Station Post Axicom

TE's Axicom Composite Insulators have been in service worldwide for more than 25 years as important components of high voltage apparatus. Modern circuit breakers, instrument transformers, cable terminations and other components in high voltage substations utilize this advanced technology for voltages up to 800 kV.

### Application

Busbar support and disconnect switches in high contamination areas and/or areas with seismic threats. These insulators can change a normal air insulated substation into a "minimum maintenance substation".

Code	Technical Reference Number	Highest System Voltage	Impulse Withstand (BIL)	Low-frequency Wet Withstand	Weight	Height (H)	Leakage Distance (L)	Arching Distance (SW)	Cantilever Strength	Deflection at 40% c. Strength	Tensile Strength	Compression Strength	Torsional Strength
SPI-		kV	kV	kV	lb	in	in	in	lb	in	lb	lb	in-lb
1.7P-550	286	115	550	230	54	45	123	37	1.700	0.23	20.000	60.000	40.000
2.6P-550	287	115	550	230	61	45	123	37	2.600	0.28	25.000	75.000	90.000
5.2P-550	287	115	550	230	96	45	122	35	5.200	0.19	25.000	75.000	90.000
1.4P-650	288	138	650	275	64	54	158	46	1.400	0.33	20.000	60.000	40.000
2.2P-650	289	138	650	275	73	54	158	46	2.200	0.41	25.000	75.000	90.000
4.4P-650	289	138	650	275	110	54	151	44	4.400	0.27	25.000	75.000	90.000
1.2P-750	291	161	750	315	73	62	186	54	1.200	0.42	20.000	60.000	40.000
1.85P-750	295	161	750	315	83	62	186	54	1.850	0.52	25.000	75.000	90.000
3.7P-750	295	161	750	315	125	62	184	52	3.700	0.35	25.000	75.000	90.000
0.95P-900	304	230	900	385	94	80	255	72	950	0.72	20.000	60.000	40.000
1.45P-900	308	230	900	385	106	80	255	72	1.450	0.88	25.000	75.000	90.000
2.2P-900	308	230	900	385	136	80	254	71	2.200	0.70	25.000	75.000	90.000
3P-900	308	230	900	385	156	80	248	70	3.000	0.60	25.000	75.000	90.000
0.8P-1050	312	315	1050	455	107	92	297	84	800	0.92	20.000	60.000	40.000
1.25P-1050	316	315	1050	455	121	92	297	84	1.250	1.15	25.000	75.000	90.000
2.3P-1050	362	315	1050	455	177	92	290	82	2.300	0.70	40.000	100.000	120.000
1P-1300	324	345	1300	525	139	106	352	98	1.000	1.41	25.000	75.000	90.000
1.45P-1300	367	345	1300	525	153	106	346	97	1.450	1.36	20.000	60.000	40.000
2P-1300	368	345	1300	525	202	106	345	96	2.000	0.94	40.000	100.000	120.000
0.9P-1470	330	500	1470	590	159	122	408	114	900	1.94	25.000	75.000	90.000
1.17P-1470	371	500	1470	590	176	122	408	113	1.170	1.67	20.000	60.000	40.000
1.75P-1470	372	500	1470	590	230	122	402	112	1.750	1.25	40.000	100.000	120.000
0.9P-1550	n/a	500	1550	620	167	128	430	120	900	2.24	20.000	60.000	40.000
1.7P-1550	379	500	1550	620	240	128	423	118	1.700	1.40	20.000	60.000	40.000
2.4P-1550	379	500	1550	620	278	128	423	118	2.400	1.54	20.000	60.000	40.000
1.4P-1800	391	500	1800	710	283	152	513	142	1.400	1.93	20.000	60.000	40.000
2P-1800	391	500	1800	710	328	152	513	142	2.000	2.14	20.000	60.000	40.000
2.8P-1800	391	500	1800	710	391	152	506	140	2.800	1.65	20.000	60.000	40.000
1.2P-2050	n/a	800	2050	830	336	182	624	172	1.200	2.84	20.000	60.000	40.000
1.6P-2050	n/a	800	2050	830	390	182	624	172	1.600	2.95	20.000	60.000	40.000
2.2P-2050	n/a	800	2050	830	464	182	617	170	2.200	2.23	20.000	60.000	40.000
1.2P-2250	n/a	800	2250	n/a	360	196	674	186	1.200	3.55	20.000	60.000	40.000
1.6P-2250	n/a	800	2250	n/a	418	196	674	186	1.600	3.68	20.000	60.000	40.000
2.2P-2250	n/a	800	2250	n/a	497	196	667	184	2.200	2.79	20.000	60.000	40.000
1P-2400	n/a	800	2400	n/a	382	208	721	198	1.000	3.54	20.000	60.000	40.000
1.4P-2400	n/a	800	2400	n/a	444	208	721	198	1.400	3.85	20.000	60.000	40.000
2P-2400	n/a	800	2400	n/a	527	208	714	196	2.000	3.03	20.000	60.000	40.000
1P-2550	n/a	800	2550	n/a	476	224	778	214	1.000	3.43	20.000	60.000	40.000
1.4P-2550	n/a	800	2550	n/a	476	224	778	214	1.400	4.80	20.000	60.000	40.000
2P-2550	n/a	800	2550	n/a	565	224	771	212	2.000	3.78	20.000	60.000	40.000



## CABLE REPAIR & REJACKETING

### **Cable Repair & Rejacketing**

GMRS Rejacketing Sleeve . . . . .	202
MBSM Wraparound Jacket Repair . . . . .	203
HVS-LR Repair Kits . . . . .	204
CRSM Wraparound Sleeves (1000 V) . . . . .	205
MRS Wraparound Flame Retardant Sleeve . . . . .	206

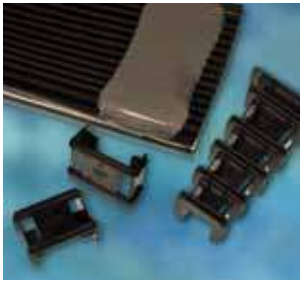

C\_GMRS\_cr

## GMRS Gray Mastic Rejacketing Sleeve

Raychem GMRS rejacketing sleeves quickly and conveniently seal and protect medium voltage cable splices up to 35 kV. GMRS rejacketing sleeves can also be used to repair cables with jacket damage. The robust, yet compact design is engineered to handle the harsh environments of manhole, direct buried or weather exposed applications.

- GMRS provides a watertight seal cover that can be used over all types and brands of push-on and cold-applied splices.
- GMRS design reduces installation space because it is not required to position a tube to the side while installing the splice. The result is easier installation in cramped manholes and less digging for direct buried applications.
- Installation is literally a snap. Installers will appreciate the simple wraparound design and dependable mastic sealing performance. To install, use the supplied pre-latch clips and installation snap tool – simply wrap and snap the sleeve on any cable in the use range.

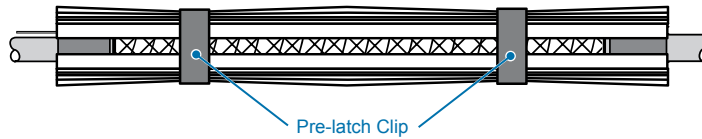

Pre-latch Clip

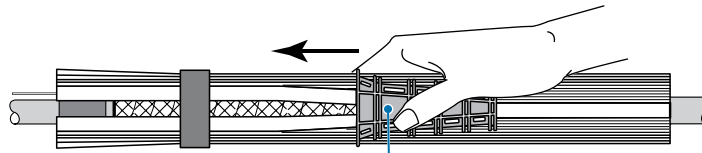

Snap Tool Installation

### Selection Information: dimensions in inches (millimeters)

Catalog Number	Sleeve Length	Cable Jacket O.D. Min.	Splice O.D. Max.	Maximum Jacket Opening
GMRS-75/25-650	25.5 (650)	1 (25)	2.5 (63)	17.5 (445)
GMRS-75/25-750	29.5 (750)	1 (25)	2.5 (63)	21.5 (545)
GMRS-75/25-850	33.5 (850)	1 (25)	2.5 (63)	25.5 (648)
GMRS-75/25-1050	41.25 (1050)	1 (25)	2.5 (63)	33.25 (820)
GMRS-75/25-1200	47.25 (1200)	1 (25)	2.5 (63)	39.25 (996)
GMRS-100/40-750	29.5 (750)	1.5 (38)	3.5 (89)	21.5 (545)
GMRS-100/40-850	33.5 (850)	1.5 (38)	3.5 (89)	25.5 (648)
GMRS-100/40-1050	41.25 (1050)	1.5 (38)	3.5 (89)	33.25 (820)
GMRS-100/40-1200	47.25 (1200)	1.5 (38)	3.5 (89)	39.25 (996)

### Ordering Information

1. Select the appropriate catalog number based on the cable diameter and the jacket opening. Cable and splice body must be within specified use range.
2. Standard package: 3 kits per box. Each kit contains one strip of mastic and one solvent wipe. Each box of 3 kits contains one installation snap tool and 2 pre-latch clips.
3. GMRS-75/25 and GMRS-100/40 meet the test requirements of IEEE 404-2006. Request EDR # 5507.



C\_MBSM\_cr

## MBSM Wraparound Jacket Repair Sleeve

Raychem MBSM repair sleeves protect cables in mechanically abusive environments, re-jacket premolded splices, repair and re-jacket LC-shielded and moisture-impervious cables and provide strain relief.

Available in five diameters with 5:1 shrink ratios.

For use on standard poly- or elastomeric-insulated/jacketed cables, which may include aluminum or steel armoring. Provides a moisture-vapor-transmission (MVT) barrier for repairing and re-jacketing LC-shield and moisture impervious cables.

**Notice: MBSM sleeves do not provide electrical insulation.**

### Selection Information: dimensions in inches (millimeters)

Catalog Number	Cable Use Range (Min.–Max.)	Sleeve Length*	Std. Pack (Kits/Box)
MBSM-43/8-1200	0.35-1.50 (9-38)	48 (1219)	6
MBSM-75/15-1200	0.65-2.65 (17-67)	48 (1219)	6
MBSM-125/30-1200	1.30-4.30 (33-109)	48 (1219)	6
MBSM-160/42-1200	1.80-5.70 (46-145)		
MBSM-200/50-1200	2.15-7.10 (55-180)		

  

Damage	Total Seal Length
<3 (<76)	3 (76)
3-12 (76-305)	4 (102)
12-24 (305-610)	6 (152)
>24 (>610)	8 (203)

### Ordering Information

1. Select appropriate catalog number based on the cable use range.
2. Kits contain a wraparound sleeve, stainless steel channel closure, and redundant sealant strips.
- \*3. Sleeve may be field-cut for shorter requirements.
4. Length tolerance is  $\pm 2\%$ .
5. Related test report: EDR-5225

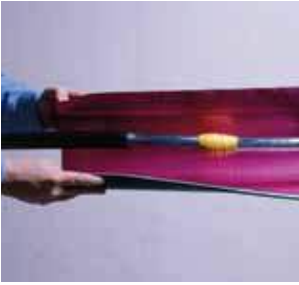

C\_HVS\_LR\_cr

## HVS-LR Lead Sheath Repair Kits for PILC Cable

The Raychem HVS-LR series kit offers a simple method of repairing lead sheath damage on paper-insulated, lead covered (PILC) cables. The kit combines the strength and durability of TE Connectivity's Raychem MBSM wraparound sleeve with an effective oil-resistant sealing mastic. The HVS-LR kits are tested to and meet the following load-cycling and pressure test requirements (see chart below for details).

### Selection Information: dimensions in inches (millimeters)

Catalog Number	Nominal Sleeve Length	Application Use Range (Min. -Max.)
HVS-LR-75/15-600	24 (600)	0.65-2.65 (17-67)
HVS-LR-75/15-1200	48 (1200)	0.65-2.65 (17-67)
HVS-LR-160/42-600	24 (600)	1.80-5.70 (46-144)
HVS-LR-160/42-1200	48 (1200)	1.80-5.70 (46-144)
HVS-LR-200/50-600	24 (600)	2.15-7.10 (55-180)
HVS-LR-200/50-1200	48 (1200)	2.15-7.10 (55-180)

*Kits do not contain connectors.*

Product Performance Test	Result
Current cycling at 110°C conductor temperature for 90 cycles (5 hours on - 3 hours off)	PASS
Applied Pressure	15 psi
Maximum continuous conductor temperature	110°C

### Ordering Information

1. Select the appropriate catalog number based on cable jacket diameter and the lead sheath diameter.
2. Standard package: 3 kits/box.
3. Related test report: EDR-5243.



C\_CRSM\_cr

## CRSM Sleeves Heat-Shrink Wraparound Sleeve (1000 V)

Raychem CRSM sleeves close easily with a permanent locking system that consists of a raised rail profile and a stainless steel channel. These sleeves are made from crosslinked polyolefin, which equals or exceeds the material properties of the original cable jacket. CRSM sleeves fit a wide range of cable sizes and have unlimited shelf life.

- Qualified to ANSI C119.1
- Rated to ICEA electrical withstand test for 1000 volts
- RUS accepted for use as jacket restoration materials on JCN cable
- For use on standard poly- or elastomeric-insulated/jacketed cables or lead-jacketed cables, which may include aluminum or steel armoring.

Use as insulation for 1/C low-voltage power cable up to 1000 volts, and for jacket repair up to 35 kV or for general sealing applications. All CRSM sleeves are sealant-coated.

### Selection Information: dimensions in inches (millimeters)

#### Primary Electrical Repair (1000 V)

Catalog Number	Sleeve Length	Cable and Jacket Repair Conductor Size Use Range (AWG/kcmil)	Use Range (Min.-Max.)	General Sealing Use Range (0-35 kV) (Min.-Max.)	Std. Pack
CRSM 34/10-200	8 (200)	#8-2/0	0.25-0.60 (6-15)	0.25-1.20 (6-30)	3
CRSM 34/10-1200	48 (1219)	#8-2/0	0.25-0.60 (6-15)	0.25-1.20 (6-30)	5
CRSM 53/13-200	8 (200)	3/0-400	0.60-0.95 (15-24)	0.60-1.80 (15-46)	10
CRSM 53/13-1200	48 (1219)	3/0-400	0.60-0.95 (15-24)	0.60-1.80 (15-46)	5
CRSM 84/20-750	30 (750)	500-1000	0.95-1.40 (24-36)	0.95-2.70 (24-69)	10
CRSM 84/20-1200	48 (1219)	500-1000	0.95-1.40 (24-36)	0.95-2.70 (24-69)	5
CRSM 107/29-1000	40 (1000)	1000-2000	1.30-2.00 (33-51)	1.30-3.60 (33-91)	10
CRSM 107/29-1200	48 (1219)	1000-2000	1.30-2.00 (33-51)	1.30-3.60 (33-91)	5
CRSM 143/36-1200	48 (1219)			1.65-4.95 (42-126)	5
CRSM 198/55-1200	48 (1219)			2.50-6.50 (64-165)	5

Damage	Total Seal Length
<3 (<76)	3 (76)
3-12 (76-305)	4 (102)
12-24 (305-610)	6 (152)
>24 (>610)	8 (203)

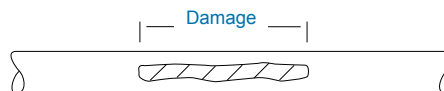

$$\text{Cut Sleeve Length} = \text{Damage Length} + \text{Total Seal Length}$$

#### Ordering Information

1. Select the appropriate catalog number for either primary electrical repair (1000 volts max.) or general sealing applications. Electrical repair selections are based on typical dimensions for low voltage insulated cable. Confirm selection with cable dimensions to assure proper sizing.
2. Use the "primary electrical repair" columns for electrical repair applications (when CRSM is in direct contact with the conductor).
3. Use the "General sealing and jacket repair use range" column for general rejacketing or sealing applications (when CRSM is not in direct contact with the conductor).
4. Package does not contain connectors.
5. Kits include a wraparound sleeve and stainless steel channel closure. Both can be field-cut for shorter requirements.
6. Related test report: EDR-5124, EDR-5192.
7. UV resistant test report: EDR-5361.
8. CRSM 34/20 are available in shorter standard lengths by ordering the corresponding CRSM-CT kits. (The use ranges in the selection information table still apply).



C\_MRS\_RS\_cr

## MRS Repair Sleeve Heat-Shrink Wraparound Flame-Retardant Sleeve (2 kV)

TE Connectivity's Raychem wraparound mining repair sleeve provides an efficient method of repairing insulation on flexible cables to 2 kV and repairing jacket damage on high-voltage cable where a splice is not required.

The specially formulated, flame-retardant, flexible wraparound sleeve installs with a low profile quickly and easily, which means the cable can be returned to service in minutes.

The sleeve is ideal for use on trailing cable as well as flexible-construction cables and conduits.

MSHA approved (P-07-KA090012-MSHA).

### Selection Information: dimensions in inches (millimeters)

Catalog Number	Cable use Range (Min. – Max.)	Sleeve Length	Std. Pack (Kits/Box)
MRS-12-10	1.00-1.60 (25-41)	10 (254)	20
MRS-12-24	1.00-1.60 (25-41)	24 (610)	10
MRS-34-24	1.60-2.30 (41-58)	24 (610)	10
MRS-34-30	1.60-2.30 (41-58)	30 (762)	10
MRS-56-30	2.30-3.50 (58-89)	30 (762)	10

*Kits do not contain connectors.*

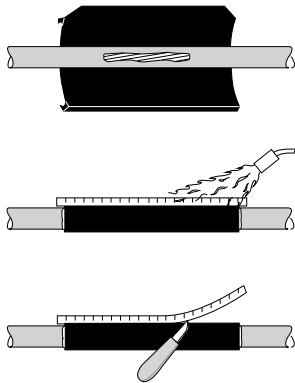

Damage	Total Seal Length
<3 (<76)	3 (76)
3-12 (76-305)	4 (102)
12-24 (305-610)	6 (152)
>24 (>610)	8 (203)

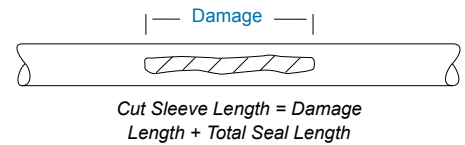

### Ordering Information

1. Select the appropriate catalog number based on cable diameter.
2. Kits do not contain connectors.
3. MRS repair sleeve is precoated with adhesive.
4. Kits contain a wraparound sleeve and stainless steel channel closure (removed after installation). Both can be field-cut for shorter requirements.
5. Related test report: EDR-5028.

*For connector information refer to the Connectors & Terminals section of this catalog.*





## TUBING & MOLDED PARTS

### Heat-Shrink Tubing

RNF-100 Tubing .....	208
MWTM Tubing .....	209
WCSM Tubing .....	210
FCSM Tubing .....	212
LVIT Tubing .....	213

### Molded Parts

ESC Sealing Caps .....	213
CFTS Seals .....	214
CBR Breakout Boot .....	215



C\_RNF\_100\_tubing

## Raychem RNF-100 Tubing

### Thin-Wall Tubing, Uncoated

- UL recognized to standard 224 (file E35586)
- Flexible, flame-retardant, thin-wall, general purpose heat-shrinkable polyolefin tubing
- Clear tubing is not flame-retardant
- Ideal for wire jacketing marking and color coding
- Black, white, and colors meet AMS-DTL-23053/5, Class 1. Clear meets AMS-DTL-23053/5, Class 2
- 2:1 shrink ratio and an unlimited shelf life when stored under normal conditions
- Order spools as RNF-100-Size-Spool Length-color
- Other sizes, colors, and packaging are available

#### Selection Information: dimensions in inches (millimeters)

Catalog Number	Inner Diameter		Recovered Wall Thickness (Mils)	Color	Feet/Spool
	as Supplied	Recovered			
RNF-100-1/16-25-(color)	.063 (1.6)	.031 (0.8)	17	BLK, WHT, CL	25
RNF-100-3/32-25-(color)	.093 (2.4)	.046 (1.2)	20	BLK, WHT, CL	25
RNF-100-1/8-25-(color)	.125 (3.2)	.062 (1.6)	20	BLK, WHT, CL	25
RNF-100-1/8-500-(color)	.125 (3.2)	.062 (1.6)	20	BLK, WHT, RED	500
RNF-100-3/16-25-(color)	.187 (4.8)	.093 (2.4)	20	BLK, WHT, CL	25
RNF-100-1/4-25-(color)	.250 (6.4)	.125 (3.2)	25	BLK, WHT, CL	25
RNF-100-1/4-250-(color)	.250 (6.4)	.125 (3.2)	25	BLK, WHT, RED	250
RNF-100-3/8-25-(color)	.375 (9.6)	.187 (4.8)	25	BLK, WHT, CL	25
RNF-100-3/8-200-(color)	.375 (9.6)	.187 (4.8)	25	BLK, WHT, RED, GRN, BLUE	200
RNF-100-1/2-25-(color)	.500 (13)	.250 (6.4)	25	BLK, WHT, CL	25
RNF-100-1/2-150-(color)	.500 (13)	.250 (6.4)	25	BLK, WHT, RED, GRN, BLUE	150
RNF-100-3/4-25-(color)	.750 (19)	.375 (9.6)	30	BLK, WHT, CL	25
RNF-100-1-25-(color)	1.000 (25)	.500 (13)	35	BLK, WHT, CL	25
RNF-100-1 1/2-25-(color)	1.500 (38)	.750 (19)	40	BLK, WHT, CL	25
RNF-100-2-25-(color)	2.000 (51)	1.00 (25)	45	BLK, WHT, CL	25



UL recognized to Standard 224  
600V/125°C



C\_MWTM\_tubing

## Raychem MWTM Tubing

### Medium-Wall Sealant-Coated or Uncoated Tubing (600 V)

- Sealant-coated MWTM tubing (-S designation) is for use as insulation/jacket repair up to 600 V or for general sealing and re-jacketing of polymeric- or elastomeric-insulated cables up to 35 kV
- RUS accepted as jacket restoration of JCN cable
- Uncoated MWTM tubing (-U or -A/U) is for cable re-jacketing only
- 3:1 shrink ratio and an unlimited shelf life when stored under normal conditions

#### Selection Information: dimensions in inches (millimeters)

Catalog Number	Use Range (Min.-Max.)	Cut-Piece Length	Min. Cont. Length	Std. Package		
				Box	Spool	Bulk Spool
<b>Sealant-Coated, Cut-Length Tubing</b>						
MWTM-10/3-1200-S	0.13-0.35 (3-9)	48 (1200)		25		
MWTM-16/5-1200-S	0.25-0.55 (6-14)	48 (1200)		25		
MWTM-25/8-1200-S	0.35-0.85 (9-22)	48 (1200)		25		
MWTM-35/12-1200-S	0.50-1.25 (13-32)	48 (1200)		25		
MWTM-50/16-1200-S	0.65-1.70 (17-43)	48 (1200)		15		
MWTM-85/25-1200-S	1.00-2.90 (25-74)	48 (1200)		5		
MWTM-115/34-1200-S	1.40-3.90 (36-99)	48 (1200)		5		
MWTM-140/42-1200-S	1.80-4.70 (46-119)	48 (1200)		5		
<b>Uncoated, Spooled Tubing</b>						
MWTM-10/3-A/U	0.13-0.35 (3-9)		25 (7.6)		100 (30)	
MWTM-16/5-A/U	0.25-0.55 (6-14)		25 (7.6)		100 (30)	1155 (350)
MWTM-25/8-A/U	0.35-0.85 (9-22)		25 (7.6)		100 (30)	660 (200)
MWTM-35/12-A/U	0.50-1.25 (13-32)		25 (7.6)		100 (30)	495 (150)
MWTM-50/16-A/U	0.65-1.70 (17-43)		15 (4.6)		75 (23)	330 (100)
<b>Uncoated, Cut-Piece Tubing</b>						
MWTM-85/25-1500/U	1.00-2.90 (25-74)	60 (1500)		5		
MWTM-115/34-1500/U	1.40-3.90 (36-99)	60 (1500)		5		
MWTM-140/42-1500/U	1.80-4.70 (46-119)	60 (1500)		5		

#### Ordering Information

1. Select the appropriate catalog number. Confirm selection with application dimensions to assure proper sizing.
2. MWTM is a general purpose tubing; for sealing applications use MWTM with sealant (-S) or use uncoated MWTM (-U or -A/U) in combination with S-1052 sealant. Order sealants separately.
3. For testing information refer to the Technical Data section of this catalog.
4. UV resistant test report: EDR-5361.

*For connector information refer to the Connectors and Terminals section of this catalog.*



C\_WCSM\_tubing

## Raychem WCSM Tubing Heavy-Wall Sealant Coated Tubing (1000 V)

- For use on standard poly or elastomeric insulated / jacketed cable or lead-jacketed cables, which may include aluminum or steel armoring.
- WCSM tubing can be used to seal an in-line splice or terminal lug seal for non-flame retardant applications, cable re-jacketing and mechanical protection.
- WCSM tubing sizes 12-3 through 70-20 is UL and cUL listed per 486D (file E91151).
- Qualified to ANSI C119.1 and rated to Western Underground guide 2.5. Also RUS accepted for use as a secondary tap or splice cover, and for use as jacket restoration materials on JCN cable.
- WCSM tubing may be used for jacket repair on cables up to 35kV.
- WCSM tubing has a 4:1 shrink ratio and an unlimited shelf life when stored under normal conditions.

*Note: UL listing applies to WCSM 12/3 through 70/20 only. WCSM 110/30 and 130/35 have not been evaluated to the UL standards. WCSM is no longer offered as an uncoated option. You can substitute either WCSM coated or MWTM uncoated depending on which will work for your application.*

### Selection Information: dimensions in inches (millimeters)

Catalog Number Tubing Size	1000 V Cable Nominal Use Range AWG/kcmil		Maximum Connector OD	UL Conductor Use Range Min-Max	General Conductor Use Range Min-Max	Maximum Connector Opening "A"	Minimum Seal Length per Side
	Min	Max					
WCSM-12/3-150-S	#14	#6	0.29	.13-.30 (3.5-7.7)	.13-.39 (3.5-10)	2.4	1.5
WCSM-12/3-300-S	#14	#6	0.29	.13-.30 (3.5-7.7)	.13-.39 (3.5-10)	7.8	1.5
WCSM-12/3-1200-S	#14	#6	0.29	.13-.30 (3.5-7.7)	.13-.39 (3.5-10)	39.3	1.5
WCSM-16/4-150-S	#8	#2	0.41	.17-.41 (4.5-10.5)	.17-.55 (4.5-14)	1.4	2
WCSM-16/4-300-S	#8	#2	0.41	.17-.41 (4.5-10.5)	.17-.55 (4.5-14)	6.8	2
WCSM-16/4-1200-S	#8	#2	0.41	.17-.41 (4.5-10.5)	.17-.55 (4.5-14)	38.3	2
WCSM-24/6-150-S	#6	#4/0	0.69	.25-.64 (6.5-16.5)	.25-.86 (6.5-22)	1.4	2
WCSM-24/6-225-S	#6	#4/0	0.69	.25-.64 (6.5-16.5)	.25-.86 (6.5-22)	3.96	2
WCSM-24/6-300-S	#6	#4/0	0.69	.25-.64 (6.5-16.5)	.25-.86 (6.5-22)	6.8	2
WCSM-24/6-1200-S	#6	#4/0	0.69	.25-.64 (6.5-16.5)	.25-.86 (6.5-22)	38.3	2
WCSM-34/8-150-S	#2	500	1.06	.35-.94 (9-24)	.35-1.22 (9-31)	1.4	2
WCSM-34/8-200-S	#2	500	1.06	.35-.94 (9-24)	.35-1.22 (9-31)	3.02	2
WCSM-34/8-225-S	#2	500	1.06	.35-.94 (9-24)	.35-1.22 (9-31)	3.96	2
WCSM-34/8-300-S	#2	500	1.06	.35-.94 (9-24)	.35-1.22 (9-31)	6.8	2
WCSM-34/8-1200-S	#2	500	1.06	.35-.94 (9-24)	.35-1.22 (9-31)	38.48	2
WCSM-48/12-150-S	#2/0	750	1.3	.51-1.12 (13-28.5)	.51-1.73 (13-44)	1.4	2
WCSM-48/12-225-S	#2/0	750	1.3	.51-1.12 (13-28.5)	.51-1.73 (13-44)	3.96	2
WCSM-48/12-300-S	#2/0	750	1.3	.51-1.12 (13-28.5)	.51-1.73 (13-44)	6.8	2
WCSM-48/12-1200-S	#2/0	750	1.3	.51-1.12 (13-28.5)	.51-1.73 (13-44)	38.3	2
WCSM-56/16-225-S	250	1000	1.5	.68-1.27 (17.5-32.5)	.70-1.96 (17.5-50)	3.96	2
WCSM-56/16-300-S	250	1000	1.5	.68-1.27 (17.5-32.5)	.70-1.96 (17.5-50)	6.62	2
WCSM-56/16-1200-S	250	1000	1.5	.68-1.27 (17.5-32.5)	.70-1.96 (17.5-50)	38.3	2
WCSM-70/20-300-S	500	1500	1.84	.92-1.40 (22-35.8)	.86-2.48 (22-63)	5.8	2.5
WCSM-70/20-450-S	500	1500	1.84	.92-1.40 (22-35.8)	.86-2.48 (22-63)	10.93	2.5
WCSM-70/20-600-S	500	1500	1.84	.92-1.40 (22-35.8)	.86-2.48 (22-63)	16.26	2.5
WCSM-70/20-1200-S	500	1500	1.84	.92-1.40 (22-35.8)	.86-2.48 (22-63)	37.3	2.5
WCSM-110/30-300-S	1250	2000	-	-	1.29-3.93 (33-100)	-	2.5
WCSM-110/30-1200-S	1250	2000	-	-	1.29-3.93 (33-100)	-	2.5
WCSM-130/35-300-S	1500	2500	-	-	1.49-4.64 (39-118)	-	2.5
WCSM-130/35-450-S	1500	2500	-	-	1.49-4.64 (39-118)	-	2.5
WCSM-130/35-1200-S	1500	2500	-	-	1.49-4.64 (39-118)	-	2.5

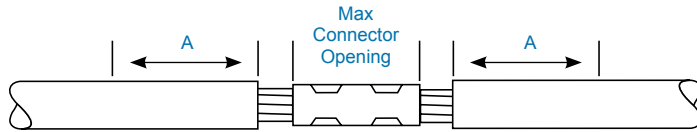

### Ordering Information

1. Select the appropriate catalog number based on typical dimensions for low-voltage insulated cable. Confirm selection with dimensions to assure proper sizing. For general conductor use or UL conductor use.”
2. Package does not contain connectors or lugs. Installed connector or lug diameter must be within use range.
3. WCSM tubing may be field-cut for shorter requirements
4. Bulk packaging is available for cut lengths. Consult your TE representative for more information.
5. UL listing applies to WCSM 12/3 through 70/20 only. WCSM 110/30 and 130/35 are not UL listed.
6. Related test reports: EDR 5541, PII 56428

*For connector information refer to the Connectors and Terminals section of this catalog.*



Wire Connector System for Use  
With Underground Connectors  
96J4



C\_FCSM\_tubing

## Raychem FCSM Tubing

### Heavy-Wall Flame Retardant Tubing (2000 V)

FCSM tubing's tough, crosslinked polyolefin construction provides mechanical strength and cut-through resistance equal to, or surpassing, the properties of low-voltage cable jackets.

- 3:1 shrink ratio and an unlimited shelf life when stored under normal conditions
- Uses sealant-coated tubing (-S) as a sealed in-line splice or terminal lug seal. It provides a watertight seal for direct-buried applications and wet environments.
- Use uncoated tubing (-U) for cable rejacketing only
- Sealant-coated or uncoated tubing may be used for jacket repair on cable to 35 kV. Qualified to ANSI C119.1; also rated to IEEE 383 (Vertical Tray Flame Test) and ICEA S-19-81. FCSM is also MSHA approved (P-07-KA090013-MSHA).

For use on standard poly- or elastomeric- insulated/jacketed cables or lead-jacketed cables, which may include aluminum or steel armoring.

Connectors up to 6 inches: Recommended cut length = connector length + 4 inches.

Connectors over 6 inches: Recommended cut length = connector length + 5 inches.

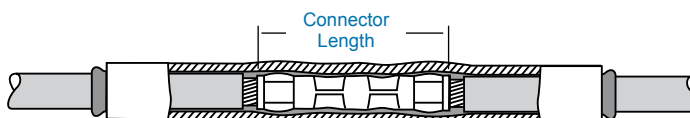

#### Selection Information: dimensions in inches/feet (millimeters/meters)

Catalog Number	2000 V Insulated		Tube Length*	Std. Pack	Bulk Option
	Conductor Size (AWG/kcmil)	General Use Range (Min.-Max.)		Ft.(m)/Roll	Pcs/Box Ft.(m)/Roll
<b>In-Line Splice Or Terminal Lug Seal (With Sealant)</b>					
FCSM-9/3-1200-S	#14-#8	0.15-0.30 (4-8)	48 (1200)		25
FCSM-19/6-150-S	#6-#2	0.25-0.65 (6-17)	6 (150)		50
FCSM-19/6-1200-S	#6-#2	0.25-0.65 (6-17)	48 (1200)		25
FCSM-28/9-225-S	#2-4/0	0.40-0.95 (10-24)	9 (225)		50
FCSM-28/9-1200-S	#2-4/0	0.40-0.95 (10-24)	48 (1200)		25
FCSM-38/12-300-S	1/0-350	0.50-1.30 (13-33)	12 (300)		40
FCSM-38/12-1200-S	1/0-350	0.50-1.30 (13-33)	48 (1200)		10
FCSM-51/16-300-S	250-500	0.70-1.75 (18-44)	12 (300)		30
FCSM-51/16-1200-S	250-500	0.70-1.75 (18-44)	48 (1200)		10
FCSM-68/22-1200-S	600-1000	0.95-2.30 (25-58)	48 (1200)		10
FCSM-90/30-1200-S	800-1200	1.30-3.10 (33-79)	48 (1200)		5
FCSM-120/40-1200-S	1500-2500	1.75-4.10 (44-104)	48 (1200)		5
FCSM-177/63 600-S		2.75-6.05 (70-154)	24 (600)		6
FCSM-177/63-1200-S		2.75-6.05 (70-154)	48 (1200)		5

#### Cable Rejacketing (Without Sealant)

FCSM-9/3-A/U	#14-#8	0.15-0.30 (4-8)		100 (30)	
FCSM-19/6-A/U	#6-#2	0.25-0.65 (6-17)		100 (30)	825 (250)
FCSM-28/9-A/U	#2-4/0	0.40-0.95 (10-24)		65 (20)	495 (150)
FCSM-38/12-A/U	1/0-350	0.50-1.30 (13-33)		50 (15)	395 (120)
FCSM-51/16-A/U	250-500	0.70-1.75 (18-44)		40 (12)	330 (100)
FCSM-68/22-A/U	600-1000	0.95-2.30 (25-58)		80 (24)	
FCSM-90/30-1500/U	800-1200	1.30-3.10 (33-79)	60 (1500)		5
FCSM-120/40-1500/U	1500-2500	1.75-4.10 (44-104)	60 (1500)		5
FCSM-177/63-1500/U		2.75-6.05 (70-154)	60 (1500)		5

\*Length tolerance to  $\pm 2$  percent.

#### Ordering Information

1. Select the appropriate catalog number based on typical dimensions for low-voltage insulated cable. Confirm selection with cable dimensions to assure proper sizing.
2. Connectors or lugs not included.
3. If sealing is needed with uncoated FCSM tubing (-/U), order S-1052 separately.
4. Tubing may be field-cut for shorter requirements.
5. Bulk packaging is available for cut-lengths. Contact your TE Connectivity representative for additional information.
6. Related test reports: EDR-5133, EDR-5134, EDR-5141.

For connector information refer to the Connectors and Terminals section of this catalog.



C\_LVIT\_tubing

## LVIT Tubing Busbar Insulating Tubing (1000 V)

Raychem LVIT is a heat-shrinkable medium-wall, flame-retardant, low voltage tubing for insulating straight and bent busbars during original equipment assembly or in retrofit applications where access to one end of the busbar is available.

When used according to the selection guidelines, LVIT may be used in applications up to 1 kV in accordance with ANSI/IEEE C37.20 specification. LVIT tubing may be used in applications up to 3.6 kV in accordance with IEC specifications.

Rated to ANSI/IEEE C37.20.1. UL recognized to Standard 224 (file E137416), 600 V-125°C-VW.1.

### Selection Information: dimensions in inches (millimeters)

Catalog Number	Busbar dimensions			LVIT Tubing Dia. as Supplied & Fully Recovered (Min.–Max.)	Std. Pack
	Rectangular Bar* (Bus Width)	Square Bar (Each Side)	Round Bar (Dia. Min.–Max.)		
LVIT-30/10-A/U	0.50-1.0 (12-25)		0.40-1.0 (11-25)	1.18-0.39 (30-10)	200 ft.
LVIT-75/25-A/U	2.0-3.0 (50-75)	1 (25)	1.0-2.0 (25-50)	2.95-0.98 (75-25)	100 ft.
LVIT-150/50-A/U	4.0-6.0 (100-150)	2-3 (50-75)	2.0-4.0 (50-100)	5.91-1.97 (150-50)	100 ft.

\*Rectangular bus thickness range is 1/4 to 5/8 inch.

### Molded Parts



C\_ESC\_Caps\_tubing

## Raychem ESC Sealing Caps End Sealing Caps for 1/C Power Cable (1000 V)

- Shrink and compress a hot-melt adhesive on the cable jacket, forming a secure environmental seal
- Fits easily over the cable end and shrinks in seconds, leaving a compact, rugged end seal
- Qualified to ANSI C119.1 and rated to ICEA electrical withstand test for 1000 volts
- For use on standard poly- or elastomeric insulated/ jacketed cables or lead-jacketed cables, which may include aluminum or steel armoring.

Use as a live end seal to 1000 volts. Use as an end seal for storage and pulling of de-energized cable.

### Selection Information: dimensions in inches (millimeters)

Catalog Number	Primary Insulation Conductor Size (AWG/kcmil)	(1000 V) Use Range (Min.–Max.)	General Use Range (Min.–Max.)	Length L	Std. Pack (Pcs/Box)
ESC-1/A	#12-#8	0.17-0.35 (4-9)	0.15-0.30 (4-8)	1.0	50
ESC-2/A	#6-3/0	0.31-0.71 (8-18)	0.30-0.70 (8-18)	2.0	50
ESC-3/A	4/0-750	0.65-1.25 (17-32)	0.65-1.25 (17-32)	3.5	40
ESC-4/A	750-1500	1.08-1.94 (27-49)	1.05-1.95 (27-50)	5.3	20
ESC-5/A	1500-2000	1.38-2.58 (35-66)	1.30-2.65 (33-67)	6.7	10
ESC-6/A		1.94-3.54 (49-90)	1.85-3.70 (47-94)	5.6	10
ESC-7/A		3.02-4.25 (77-108)	2.95-4.50 (75-114)	5.4	10

\*5 packs, each with 5 pcs. per Point of Purchase Package.

Each energized conductor requires a separate ESC sealing cap.

### Ordering information

1. Select the appropriate catalog number based on the conductor size or use range. Confirm selection with dimensions to assure proper sizing.
2. Each energized conductor requires a separate ESC sealing cap.
3. Bulk options also available. Consult your TE Connectivity representative for information.
4. Caps are coated with an adhesive.
5. Related test report: EDR-5161.



C\_CFTS\_tubing

## CFTS Seals Heat-Shrink Cabinet Feed-Through Seals

Raychem CFTS seals are heat-shrinkable molded parts for moisture-sealing applications where cable enters enclosures, such as cabinets or connection boxes.

- Suitable for environments that have existing periodic pressure difference and/or temperature differential
- Precoated with a thermoplastic adhesive that seals around the entering cable. The O-Ring creates the water/air seal at the cabinet entry.
- Utilizes a rigid plastic that, when inserted through the cabinet wall, protects the entering cable from abrasion or cut-through

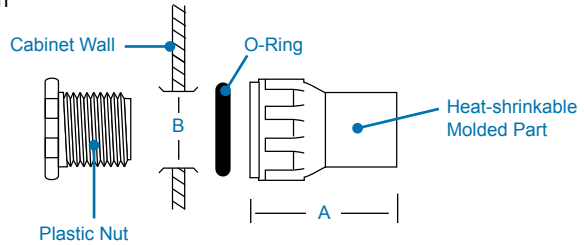

### Selection Information: dimensions in inches (millimeters)

Catalog Number	Cable Diameter (Min. – Max.)	Length of Molded Part	Clearance (Knockout) Hole Size	Std. Pack
		A	B	
CFTS-1	0.20-0.40 (5-10)	2.75 (70)	1 (25)	5
CFTS-2	0.25-0.65 (6-17)	2.75 (70)	1 (25)	5
CFTS-3	0.55-1.00 (14-25)	3.75 (95)	1.375 (35)	5
CFTS-4	0.80-1.45 (20-37)	4.50 (114)	2 (51)	5
CFTS-5	1.45-2.40 (37-61)	7.00 (178)	3.5(89)	5



C\_CBR\_Boot\_tubing

## CBR Breakout Boot Heat-Shrink Cable Breakout Boots

Raychem CBR products seal breakouts in multiconductor cables and conduit.

These seals are made of tough, crosslinked polyolefin to provide mechanical protection and strain relief. CBR seals have an adhesive-coating on the body and the legs to form a durable watertight seal, and conform tightly to conduits and cable jackets.

For use on standard poly- or elastomeric insulated/jacketed multiconductor cables or cables in metal or plastic conduits.

### Selection Information: dimensions in inches (millimeters)

Catalog Number	Cross Section	Body Use Range (Min.-Max.)	Legs Use Range (Min.-Max.)	Std. Pack
CBR-2-1-A		0.35-1.00 (9-25)	0.15-0.55 (4-14)	3
CBR-2-2-A*		1.25-1.70 (32-43)	0.30-0.75 (8-19)	3
CBR-2-3-A		1.65-3.00 (42-76)	0.65-1.40 (17-36)	3
CBR-3-1-A		0.50-1.35 (13-34)	0.20-0.55 (5-14)	3
CBR-3-2-A*		0.85-2.20 (22-56)	0.35-0.90 (9-23)	3
CBR-3-3-A*		1.10-2.90 (28-74)	0.50-1.25 (13-32)	3
CBR-3-4-A		2.35-5.65 (60-144)	1.20-2.10 (30-53)	3
CBR-4-1-A		0.70-1.25 (18-32)	0.15-0.45 (4-11)	3
CBR-4-2-A*		1.00-2.10 (25-53)	0.35-0.90(9-23)	3
CBR-4-3-A*		1.20-3.50 (30-89)	0.55-1.40 (14-36)	3
CBR-4-4-A		2.35-6.05 (60-154)	0.90-1.50 (23-38)	3
CBR-6-1-A*		1.45-3.85 (37-98)	0.60-1.50 (15-38) phase	3
CBR-6-2-A*		2.65-5.30 (67-135)	0.30-0.75* (8-19) ground	3
			0.40-0.95* (10-24) ground	6

\*CBR-Plugs are for blocking and sealing unused legs of breakouts. The plug will fit those items asterisked (\*) above.





## TAPES & SEALANTS

### Tapes

Raychem Electrical PVC Tape .....	216
CRPS Repair Tape .....	218
FSTW Splicing Tape .....	219
MVFT Medium Voltage Fusion Tape .....	219
LVBT Busbar Tape .....	220
HVBT High Voltage Busbar Insulating Tape .....	221

### Sealants

Hot-Melt and Cold-Applied Sealants .....	222
--	-----



C\_Tape\_tape

## Raychem Electrical PVC Tape

TE Raychem offers PVC electrical tapes for applications up to 600 Volts which are pressure sensitive, lead-free, UV resistant, flame retardant, and suitable to various temperature ratings. TE Raychem tapes are offered in three grades:

**Professional Grade** – provides premium all-weather resistance, adhesion strength, electrical insulation, abrasion resistance and performance over a wide range of temperatures.

**Commercial Grade** – provides excellent all-around performance for harnessing, insulating, identification and abrasion applications.

**General Purpose Grade** – provides an economical solution for harnessing and identification of electrical phases, circuits, feeders and branches.

### Selection Information:

Product Description	Grade	Mil Thickness	Temperature Rating	Specification, Certificate	Description
3030*	Professional	7 Mil (0.18 mm)	220 F (105 C)	ASTM-D-1000, CSA C22.2	Black all-weather resistant tape, excellent for cold weather applications, primary insulation and protective jacketing.
7070*	Professional	7 Mil (0.18 mm)	220 F (105 C)	ASTM-D-1000, CSA C22.2	All-weather resistant tape available in nine fade-resistant colors, excellent for phase identification, primary insulation and protective jacketing.
8080*	Professional	8.5 Mil (0.21 mm)	220 F (105 C)	ASTM-D-1000, CSA C22.2	Black all-weather resistant tape, excellent for cold weather applications, thicker tape for easier insulation build up and exceptional abrasion resistance.
5050	Commercial	7 Mil (0.18 mm)	194 F (90 C)	ASTM-D-1000, UL510, CSA C22.2	Black, commercial grade tape rated to 194°F (90°C), recommended for insulation and harnessing.
2020*	Commercial	10 Mil (0.25 mm)	176 F (80 C)	ASTM-D-1000	Black heavy-duty tape, ideal for maximum abrasion resistance.
1818	General Purpose	7 Mil (0.18 mm)	176 F (80 C)	ASTM-D-1000, UL510, CSA C22.2	Available in black and nine fade-resistant colors, recommended for phase identification.

\* UL 510 Certification in progress

For additional technical information contact your local TE representative.

**Most commonly requested part numbers:**

Product Description	Catalog Number	Color	Thickness mil (mm)	Roll Width inches (mm)	Roll Length feet (m)	Package Type	Case Qty
3030*	ETP-3030-0-19-20-A	Black	7 (0.18)	3/4 (19)	66 (20.1)	Cellophane	100
	ETP-3030-0-19-20-P-A	Black	7 (0.18)	3/4 (19)	66 (20.1)	Plastic Case	20
7070*	ETP-7070-5-19-20-P-A	Green	7 (0.18)	3/4 (19)	66 (20.1)	Plastic Case	20
	ETP-7070-4-19-20-P-A	Yellow	7 (0.18)	3/4 (19)	66 (20.1)	Plastic Case	20
	ETP-7070-2-19-20-P-A	Red	7 (0.18)	3/4 (19)	66 (20.1)	Plastic Case	20
	ETP-7070-6-19-20-P-A	Blue	7 (0.18)	3/4 (19)	66 (20.1)	Plastic Case	20
	ETP-7070-9-19-20-P-A	White	7 (0.18)	3/4 (19)	66 (20.1)	Plastic Case	20
	ETP-7070-1-19-20-P-A	Brown	7 (0.18)	3/4 (19)	66 (20.1)	Plastic Case	20
	ETP-7070-3-19-20-P-A	Orange	7 (0.18)	3/4 (19)	66 (20.1)	Plastic Case	20
	ETP-7070-8-19-20-P-A	Gray	7 (0.18)	3/4 (19)	66 (20.1)	Plastic Case	20
	ETP-7070-7-19-20-P-A	Violet	7 (0.18)	3/4 (19)	66 (20.1)	Plastic Case	20
8080*	ETP-8080-0-19-20-A	Black	8.5 (0.21)	3/4 (19)	66 (20.1)	Cellophane	100
	ETP-8080-0-19-20-P-A	Black	8.5 (0.21)	3/4 (19)	66 (20.1)	Plastic Case	20
	ETP-8080-0-25-20-B	Black	8.5 (0.21)	1 (25.4)	66 (20.1)	Cellophane	50
	ETP-8080-0-38-20-B	Black	8.5 (0.21)	1-1/2 (38)	66 (20.1)	Cellophane	50
5050	ETP-5050-0-19-20-B	Black	7 (0.18)	3/4 (19)	66 (20.1)	Cellophane	100
2020*	ETP-2020-0-25-33-B	Black	10 (0.25)	1 (25.4)	36 yd (32.9)	Cellophane	48
	ETP-2020-0-51-33-B	Black	10 (0.25)	2 (51.4)	36 yd (32.9)	Cellophane	12
	ETP-2020-0-38-33-B	Black	10 (0.25)	1-1/2 (38)	36 yd (32.9)	Cellophane	12
	ETP-2020-0-19-33-B	Black	10 (0.25)	3/4 (19)	36 yd (32.9)	Cellophane	48
1818	ETP-1818-0-19-20-B	Black	7 (0.18)	3/4 (19)	66 (20.1)	Cellophane	100
	ETP-1818-5-19-20-B	Green	7 (0.18)	3/4 (19)	66 (20.1)	Cellophane	100
	ETP-1818-4-19-20-B	Yellow	7 (0.18)	3/4 (19)	66 (20.1)	Cellophane	100
	ETP-1818-2-19-20-B	Red	7 (0.18)	3/4 (19)	66 (20.1)	Cellophane	100
	ETP-1818-6-19-20-B	Blue	7 (0.18)	3/4 (19)	66 (20.1)	Cellophane	100
	ETP-1818-9-19-20-B	White	7 (0.18)	3/4 (19)	66 (20.1)	Cellophane	100
	ETP-1818-1-19-20-B	Brown	7 (0.18)	3/4 (19)	66 (20.1)	Cellophane	100
	ETP-1818-3-19-20-B	Orange	7 (0.18)	3/4 (19)	66 (20.1)	Cellophane	100
	ETP-1818-8-19-20-B	Gray	7 (0.18)	3/4 (19)	66 (20.1)	Cellophane	100
	ETP-1818-7-19-20-B	Violet	7 (0.18)	3/4 (19)	66 (20.1)	Cellophane	100

\* UL 510 Certification in progress

Note: A = 1 inch core, B = 1-1/2 inch core

For additional options contact your local TE representative.



C\_CRPS\_tape

## CRPS Repair Tape

### Flexible Cable Repair Tape

Raychem CRPS repair strip is a high-quality replacement jacket for low and high voltage flexible mining cables. It is a tool-free, flexible, flame-retardant elastomeric strip that has been specially formulated to provide excellent resistance to abrasion, tearing, and cutting.

- Precoated with a thermoplastic sealant that provides an excellent seal against moisture and corrosive elements
- MSHA approved (No. P-137-13-MSHA)
- Tool-free, flexible, flame-retardant elastomeric strip for jacket repair on mining and other flexible cable

#### Selection Information: dimensions in inches (millimeters)

Catalog Number	Strip Length	Strip Width	Std. Pack (Strips/Box)
CRPS-248	48 (1219)	2 (51)	20
CRPS-260	60 (1524)	2 (51)	20
CRPS-290	90 (2286)	2 (51)	15
CRPS-2120	120 (3048)	2 (51)	10

#### Approximate Coverage Length

Cable Diameter	CRPS-248	CRPS-260	CRPS-290	CRPS-2120
0.50 (13)	28 (711)	36 (914)	55 (1397)	73 (1854)
0.75 (19)	18 (457)	23 (584)	37 (940)	49 (1245)
1.00 (25)	14 (356)	17 (432)	26 (660)	35 (889)
1.25 (32)	11 (279)	14 (355)	21 (533)	28 (711)
1.50 (38)	9 (229)	11 (279)	18 (457)	24 (610)
1.75 (44)	7 (178)	9 (228)	15 (381)	20 (508)
2.00 (51)		8 (203)	14 (356)	19 (483)
2.50 (64)			10 (254)	13 (330)
3.00 (76)			9 (229)	12 (305)

#### Ordering Information

1. Select the appropriate catalog number based on cable diameter and length of cable damage to be covered (see "Approximate coverage length" chart above). For larger damaged areas, multiple strips may be used to provide continuous coverage.
2. To install, half-lap CRPS repair strip on cable, beginning 3" before damage and continuing 3 inches after damage.
3. CRPS repair strip is pre coated with a thermoplastic sealant.
4. Related test report: EDR-5068.

*Recommended coverage area includes 3 inches on either side of damaged area.*





C\_FSTW\_tape

## FSTW Splicing Tape

### Fast Splicing Tape Wrap

TE's Raychem FSTW is a thermoplastic rubber tape combined with a butyl rubber sealant specially formulated for underground applications. FSTW is ideal for repairing cable jackets, sealing low-voltage splices, and re-jacketing MV cable splices.

This tape provides a complete re-jacketing solution in one pass as opposed to the multi-layer construction required when using traditional tape products. It's quick to install. There is no need for separate sealing mastic and tape as it combines sealant and rubber tape in one convenient product.

FSTW rubber tape is 50 mils thick, which offers strong puncture resistance from underground material and debris. FSTW is rated for use on 90°C rated cables, in underground use, in acid or caustic soils, and saltwater environments. It is UV resistant and rated for aerial exposure.

Mastic is in contact with cable surface only at ends which allows for easy removal.

Splices made with FSTW qualify to ANSI C119.1

#### Selection Information: dimensions in feet (meters)

Catalog Number	Roll Width	Roll Length	Std. Pack
FSTW-2-1-6	2 (50)	6' (1.8)	12

#### Approximate Coverage Length

Catalog Diameter	FTSW-2-1-4	FTSW-2-1-6
0.50 (13)	28 (710)	42 (1000)
0.75 (19)	18 (460)	27 (680)
1.00 (25)	14 (355)	21 (530)
1.25 (32)	11 (280)	17 (430)
1.50 (38)	9 (230)	14 (355)
1.75 (44)	7 (180)	10 (280)
2.00 (51)	6 (150)	9 (230)
2.50 (63)		7 (180)
3.00 (76)		6 (150)

#### Ordering Information

1. See the approximate coverage length per roll based on cable diameter.
2. For repairing cable jackets, install the FSTW tape beginning 2" before the damage and continuing 1" after the damage.
3. FSTW is 2" (50) wide.
4. Related test reports: EDR-5431, EDR-5360.



C\_MVFT\_tape

## MVFT

### Medium Voltage Fusion Tape

Raychem Medium Voltage Fusion Tape (MVFT) is a self amalgamating tape, which provides insulation enhancement and protection against accidentally induced discharge. MVFT tape is designed to combine the integrity of a Silicone polymer with the versatility of a wraparound product.

MVFT tape is quick and easy to install. Upon application the tape amalgamates the over-lapped layers together, producing a complete seal. A single layer of MVFT tape, two-thirds overlapped, will provide AC voltage withstand (flashover protection) to at least 15 kV increasing to 35 kV if a second layer is applied. Although MVFT tape will stick to itself and other insulating materials, it will not adhere to metal or porcelain allowing easy removal for maintenance.

MVFT tape is compatible with all other products in the Raysulate MV Insulation enhancement system. This fusion tape is suitable for both indoor and outdoor use. MVFT tape exhibits non-tracking properties and possesses a continuous operating temperature up to 90°C.

MVFT tape offers a simple and effective solution to the problems of retrofit insulation of busbars particularly where existing equipment cannot be dismantled. It can be used for indoor and outdoor applications and is easily installed over a wide variety of shapes including complex connections.

#### Selection Information: dimensions in inches (millimeters)/yards (meters)

Catalog Number	Color	Width	Length	Std. Pack
MVFT-G-2-12(B4)	Gray	2 (50)	12 (11)	4 Rolls

#### Ordering Information

EDR-5465 Medium Voltage Fusion Tape Qualification Report



C\_LVBT\_tape

## LVBT Busbar Tape

### Low-Voltage Busbar Insulating Heat-Shrink Tape (1000 V)

Raychem LVBT is an adhesive-coated, low-voltage heat-shrinkable tape. One wrap insulates straight and bent bars in retrofit applications where tubing cannot be used. In addition, LVBT easily insulates unusual connections and geometries in the factory or field.

- Adhesive layer fuses the tape layers but does not stick to bus or hardware, providing tough insulation up to 1 kV in accordance with ANSI C37.20 and up to 3.6 kV in accordance with IEC specifications
- Rated to ANSI/IEEE C37.20
- UL-recognized to Standard 224 (file E137417), 600 V-125°C-VW.1

#### LVBT Tape Dimensions

Catalog Number	Roll width	Roll Length
LVBT-1-R	1 (25)	25 ft (7.5 m)
LVBT-2-R	2 (50)	25 ft (7.5 m)
LVBT-4-R	4 (100)	25 ft (7.5 m)

#### Selection Information: dimensions in feet (meters)

Bus Width	Catalog Number	Bus Length Insulated per Roll	Rolls/Std. Pack
-----------	----------------	-------------------------------	-----------------



#### Rectangular Busbar\*

1 (25)	LVBT-1-R	3.8 ft (1.2 m)	8
2 (50)	LVBT-2-R	4.8 ft (1.5 m)	4
3 (75)	LVBT-2-R	3.5 ft (1.1 m)	4
4 (100)	LVBT-2-R	2.7 ft (0.8 m)	4
6 (150)	LVBT-2-R	1.9 ft (0.6 m)	4
8 (200)	LVBT-4-R	2.9 ft (0.9 m)	4

\*Maximum thickness: 5/8 (15)



#### Square Busbar

1 (25)	LVBT-2-R	6.25 ft (2.0 m)	4
2 (50)	LVBT-2-R	3.1 ft (1.0 m)	4
3 (75)	LVBT-2-R	2.0 ft (0.6 m)	4
4 (100)	LVBT-4-R	3.1 ft (1.0 m)	2
6 (150)	LVBT-4-R	2.0 ft (0.6 m)	2



#### Round Busbar

0.5 in (12 mm)	LVBT-1-R	8.0 ft (2.6 m)	8
1.0 in (25 mm)	LVBT-2-R	8.0 ft (2.6 m)	4
2.0 in (50 mm)	LVBT-2-R	4.0 ft (1.3 m)	4
3.0 in (75 mm)	LVBT-2-R	2.6 ft (0.9 m)	4
4.0 in (100 mm)	LVBT-4-R	4.0 ft (1.3 m)	2

#### Ordering Information

1. LVBT-1-R is best for shorter lengths. LVBT-2-R is the most versatile width for general purpose use. LVBT-4-R is useful for long lengths and larger bus sizes.
2. If sealing is needed, order the S-1052-6-150 sealant strips.



C\_HVBT\_tape

## HVBT High Voltage Busbar Insulating Tape (5-15 kV)\*

Raychem HVBT tape is an adhesive coated, high-voltage, heat-shrinkable, general-purpose tape for insulating straight and bent bars in retrofit applications where tubing cannot be used. In addition, HVBT easily insulates unusual connections and geometries in the factory or field.

HVBT tape is also ideal for protection against incidental/accidental bridging caused by birds and animals. HVBT may be suitable for higher voltage applications (see Ordering information #2 below). The HVBT adhesive layer fuses the tape layers but does not stick to bus or hardware, thus providing environmental sealing while allowing fast, easy removal.

HVBT tape may be used in applications up to 15 kV in accordance with ANSI/IEEE specifications and up to 36 kV in accordance with IEC specifications.

Rated to ANSI/IEEE C37.20-1987.

### HVBT tape dimensions

Catalog Number	Roll	
	W	L
HVBT-1-R-01 (B8)	1"	25 ft.
HVBT-2-R-01 (B4)	2"	25 ft.
HVBT-4-R-01 (B2)	4"	25 ft.

### Selection Information: dimensions in inches/feet (millimeters/meters)

Bus Width	Recommended Product	Bus Length Insulated per Roll
-----------	---------------------	-------------------------------



#### Rectangular busbar

1 (25)	HVBT-1-R-01 (B8)	2.5 (0.7)
2 (50)	HVBT-2-R-01 (B4)	3.3 (1.0)
3 (75)	HVBT-2-R-01 (B4)	2.2 (0.6)
4 (100)	HVBT-2-R-01 (B4)	1.6 (0.5)
6 (150)	HVBT-2-R-01 (B4)	1.0 (0.3)
8 (200)	HVBT-4-R-01 (B2)	1.6 (0.5)

Maximum thickness: 5/8 inch (15 mm)



#### Square busbar

1 x 1 (25)	HVBT-2-R-01 (B4)	4.0 (1.2)
2 x 2 (50)	HVBT-2-R-01 (B4)	2.0 (0.6)
3 x 3 (75)	HVBT-2-R-01 (B4)	1.3 (0.4)
4 x 4 (100)	HVBT-4-R-01 (B2)	2.0 (0.6)
6 x 6 (150)	HVBT-4-R-01 (B2)	1.3 (0.4)



#### Round busbar

0.5 (12)	HVBT-1-R-01 (B8)	5.0 (1.5)
1.0 (25)	HVBT-2-R-01 (B4)	5.0 (1.5)
2.0 (50)	HVBT-2-R-01 (B4)	2.5 (0.7)
3.0 (75)	HVBT-2-R-01 (B4)	1.5 (0.4)
4.0 (100)	HVBT-4-R-01 (B2)	2.5 (0.7)

### Ordering Information

- Select the appropriate catalog number for the application. Confirm selection with the following recommendations and HVBT tape dimensions:
  - HVBT-1-R is best for short lengths and small bus sizes.
  - HVBT-2-R is the most versatile width for general purpose use.
  - HVBT-4-R is useful for long lengths and larger bus sizes.
- HVBT may be suitable for applications with higher voltage than those listed. Please contact your TE representative for more information.
- To environmentally seal the bus, order S-1251-50-300-1 or S-1251-25-300-4 sealant strips separately.
- Recommended application is to wrap the tape around the busbar using a two-thirds overlap.
- Bolted connections require two layers of tape.
- Standard package:
  - HVBT-1-R: 8 rolls/box
  - HVBT-2-R: 4 rolls/box
  - HVBT-4-R: 2 rolls/box
- Continuous operating temperature: 90°C
- Related test reports: UVR-8023, EDR-5154



C\_Sealants\_tape

## Hot-Melt and Cold-Applied Sealants

TE's Raychem adhesives are to be used for sealing the ends of uncoated tubing or for low-voltage applications requiring void-filling. The hot-melt sealants flow when heated and set when cooled to provide a superior watertight seal. The cold-applied sealants bond to surfaces when placed under pressure to create a water-tight seal.

Use sealants with uncoated tubing and molded parts for sealing applications or as an adhesion enhancement for specific applications.

### Selection Information

Sealant Type	Description	Use with These Products	Application
S-1052	General purpose low-voltage sealant	WCSM-A/U (uncoated), MWTM-A/U (uncoated), FCSM-A/U (uncoated), LVBT, LVIT	heat-shrink
S-1085	General purpose high-voltage sealant	HVS (high-voltage splices), HVT (high-voltage terminations), MCK-5	heat-shrink
S-1189	High-temperature, low-voltage sealant	MCK	heat-shrink
S-1251	High-voltage Raysulate electrical insulator sealant	BBIT, BPTM, HVBC, HVBT, HVIS	heat-shrink
S-1171	Low-voltage mining sealant	LV-MSK, HV-MSK	heat-shrink
S-1278	Low-voltage sealant	RDSS	cold-applied
GelWrap Pad	Low-voltage PowerGel sealing gel	GelWrap, GelWrap-RS closure	cold-applied

Catalog Number	Color	Dimensions (W x L x T)	Std. Pack
S-1052-3-3000	Black	Roll: 1.5 x 120 x .12	5 rolls/box
S-1171-4-300	Black	Strip: 2 x 12 x .10	100 strips/box
S-1174-2-300	Black	Strip: .5 x 12 x .09	25 strips/box
S-1174-4-460	Black	Strip: 1 x 18 x .19	15 strips/box
S-1251-25-300-4	Red	Strip: 1 x 12 x .150	25 strips/box
S-1251-50-300-1	Red	Strip: 2 x 12 x .045	25 strips/box
S-1278-3 x 61 x 7620	Gray	Roll: 2.4 x 300 x .12	1 roll/box
GelWrap Pad 2x8	Gray	Strip: 2 x 8 x .18	6 strips/box
S-1189-3-600	Yellow		

### Ordering Information

1. Select the appropriate catalog number based on the application information in columns two and three of the above table.
2. Use the information in the table above for ordering.
3. Sealants are supplied in bulk form with protective release paper.

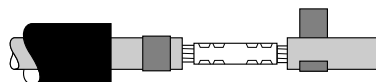





# PHOTOCONTROLS, TIMERS & ACCESSORIES

## Thermal Photocontrols

AT Series .....	224
PT / SPT Series .....	224
TL Series .....	225
AA Series .....	225
LC Series .....	226
BF Series .....	226
M Series .....	227

## Electronic Photocontrols

LM 1000 .....	227
2000 Series .....	228
3000 Series .....	229
6000 Series .....	230
7000 Series .....	231
8000 Series .....	232
SST Series .....	233

## Time Controls

24 Hour Time Clocks .....	234
Spring Wound Interval Timers .....	234

## Lighting Accessories

AMR Series .....	235
Shorting and Open Caps .....	235
AM Series .....	236
US-30 Starter .....	236
OLC/PL/ACL Series .....	236

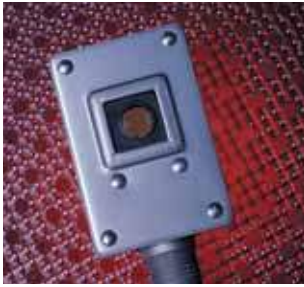

C\_AT

### AT Series

The AT series control's rugged die-cast aluminum housing makes it the ideal choice for any outdoor installation where vandalism or other types of abuse may be a concern. These controls feature a heavy-duty thermal bi-metal switch that provides a 30-45 second time delay. This virtually eliminates unwanted lamp cycling that could be caused by lightning, car headlights, or other sudden changes in the ambient light level. Although the turn-on level is pre-set at the factory, each AT control is furnished with an adjustable slide bar that allows field adjustment to satisfy specific needs.

- Tough die-cast aluminum housing
- Heavy-duty thermal bimetal switch
- UL and CSA listed
- 30-45 second time delay
- 2000 & 3000 Watt load ratings
- Fail mode is ON



#### Selection Information

Catalog Number	Rated Volts	Range (Volts)	Load Rating		Turn ON (Fc)	OFF/ON Ratio
			Tungsten (Watts)	Ballast (VA)		
AT-15	120	105-130	2000	1900	1.5	6:1
AT-168	208/240/277	185-305	2000	1900	1.5	6:1
AT-19*	480	420-530	2000	1900	1.5	6:1
AT-20	120/208/240/277	105-305	2000	1900	1.5	6:1
AT-30*	120	105-130	3000	2900	1.5	6:1
AT-368*	208/240/277	185-305	3000	2900	1.5	6:1
AT-39*	480	420-530	3000	2900	1.5	6:1

Note: 6" Lead wires  
\*Not UL or CSA Listed



C\_PT-SPT

### PT / SPT Series Non-Metallic Housing

The PT and SPT series controls combine the superior performance of the AT series with an economical, yet highly durable, polycarbonate housing. These controls feature a heavy-duty thermal bi-metal switch that provides a 30-45 second time delay. This virtually eliminates unwanted lamp cycling that could be caused by lightning, car headlights, or other sudden changes in the ambient light level. Although the Turn ON level is pre-set at the factory, each PT and SPT control is furnished with an adjustable slide bar that allows field adjustment to satisfy specific needs. The SPT is also equipped with a field adjustable swivel base to provide maximum installation flexibility.

- Fixed or adjustable swivel base
- Heavy duty thermal bimetal switch
- UL and CSA listed
- 30-45 second time delay
- 2000 Watt load rating
- Fail mode is ON



#### Selection Information

Catalog Number	Base	Rated Volts	Range (Volts)	Load Rating		Turn ON (Fc)	OFF/ON Ratio
				Tungsten (Watts)	Ballast (VA)		
<b>PT Series</b>							
PT-15	Fixed	120	105-130	2000	1900	1.5	5:1
PT-168	Fixed	208/240/277	185-305	2000	1900	1.5	5:1
PT-20	Fixed	120/208/240/277	105-305	2000	1900	1.5	5:1
PT-347**	Fixed	347	310-380	2000	1900	1.5	5:1
<b>SPT Series</b>							
SPT-15	Swivel	120	105-130	2000	1900	1.5	5:1
SPT-168	Swivel	208/240/277	185-305	2000	1900	1.5	5:1
SPT-19*	Swivel	480	420-530	2000	1900	1.5	5:1
SPT-347**	Swivel	347	310-380	2000	1900	1.5	5:1

Note: 6" Lead wires  
\*Not UL or CSA Listed  
\*\* CSA Listed only



C\_TL

### TL Series Slim Profile

The TL series controls have a thin cylindrical shape to fit neatly between twin floodlights and in other tight applications. These controls are equipped with a field adjustable swivel base that makes it easy to direct the photocell away from stray light and is "O" ring sealed to prevent water from entering through the knuckle. The TL control also features a heavy-duty thermal bi-metal switch that provides a 30-45 second time delay. This virtually eliminates unwanted lamp cycling that could be caused by lightning, car headlights, or other sudden changes in the ambient light level.

- Adjustable swivel base
- Thinline profile - perfect for tight spots
- 30-45 second time delay
- UL and CSA listed
- Durable polycarbonate housing
- Fail mode is ON



#### Selection Information

Catalog Number	Rated Volts	Range (Volts)	Load Rating		Turn ON (Fc)	OFF/ON Ratio
			Tungsten (Watts)	Ballast (VA)		
TL-115	120	105-130	1800	1100	1.5	5:1
TL-1168	208/240/277	185-305	1200	1100	1.5	5:1

Note: 6" Lead wires



C\_AA

### AA Series Button Style

The AA series control is designed for internal mounting and is constructed of a high impact, UV stabilized polycarbonate housing. The wire leads exit from the rear allowing the control to be placed in tight locations while positioning the wiring for easy access. The AA-105W and AA-1068W controls include a brushed aluminum wall plate for installation in standard outlet boxes. All AA controls utilize a heavy-duty thermal bimetal switch that provides a 30-45 second minimum time delay.

- 3/4" long threaded nipple
- 30-45 second time delay
- UL and CSA listed
- Durable polycarbonate housing
- 1800 and 1200 Watt load rating
- Fail mode is ON

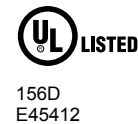

#### Selection Information

Catalog Number	Product Information	Rated Volts	Range (Volts)	Load Rating		Surge Protection (Joules)	Turn ON (Fc)	OFF/ON Ratio
				Tungsten (Watts)	Ballast (VA)			
AA-105	120	105-130	1800	1100	1.5	5:1	5:1	
AA-105W	w/Wall Plate	120	105-130	1800	1100	1.5	5:1	5:1
AA-1068	208/240/277	185-305	1200	1100	1.5	5:1	5:1	
AA-1068W	w/Wall Plate	208/240/277	185-305	1200	1100	1.5	5:1	5:1
AA-305	120	105-130	300	840	1.5	5:1	5:1	
AA-105M	15" Leads	120	105-130	1800	1100	180	1.5	5:1
AA-1068M	15" Leads	208/240/277	185-305	1200	1100	180	1.5	5:1
AA-105HA	High Ambient	120	105-130	1800	1100	1.5	5:1	5:1

Note: 6" Lead wires unless otherwise noted

### LC Series Locking Style/Residential Grade

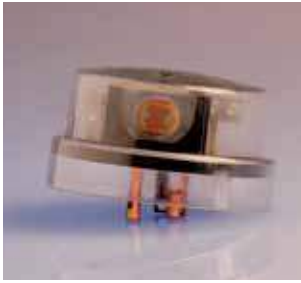

C\_LC

The LC series locking-type photocontrols offer an economical and cost-effective means of controlling residential lighting systems from dusk to dawn. These controls feature a heavy-duty bi-metal switch that produces a minimum 30-45 second time delay, virtually eliminating unwanted off/on operations that could result from lightning, car headlights, or other sudden changes in the ambient outdoor light level. LC controls are a perfect and reliable solution for lighting driveways, patios, decks, entryways or other areas around the home where security lighting is desired.

- Heavy-duty thermal bimetal switch
- 30-45 second time delay
- UL and CSA listed
- ANSI C136.10 compliant
- Fail mode is ON



128F  
PHOTOCONTROL  
E66375

Certified  
LR27428

#### Selection Information

ANSI Standard Cap Colors	
120V	Gray/Clear
208/240/277V	Maroon
120/208/240/277V	Blue

Catalog Number	Rated Volts	Range (Volts)	Load Rating		Turn ON (Fc)	OFF/ON Ratio
			Tungsten (Watts)	Ballast (VA)		
LC-120	120	105-130	1000	1800	1.5	4:1
LC-208-277	208/240/277	185-305	1000	1800	1.5	4:1



C\_BF

### BF Series Locking Style/Industrial/Commercial Grade with Surge Protection

The BF series locking-type photocontrols are engineered to meet the needs of virtually every commercial and industrial outdoor lighting control application utilizing HID luminaires equipped with locking-style receptacles. Typical applications include parking lots, security lighting, street, and other types of area lighting. The heavy-duty thermal bi-metal switch produces a minimum 30-45 second time delay, eliminating unwanted off/on operations that could be caused by lightning, car headlights, or other sudden changes in the ambient light level. BF controls are also equipped with a 180 joule MOV to protect both the photocontrol and the luminaires from sudden surges in the line voltage.

- 180 Joule MOV surge protection
- Heavy-duty thermal bimetal switch
- 30-45 second time delay
- UL and CSA listed
- ANSI C136.10 compliant
- Fail mode is ON



128F  
PHOTOCONTROL  
E66375

Certified  
LR27428

#### Selection Information

ANSI Standard Cap Colors	
120V	Gray/Clear
208/240/277V	Maroon
120/208/240/277V	Blue

Catalog Number	Rated Volts	Range (Volts)	Load Rating		Surge Protection (Joules)	Turn ON (Fc)	OFF/ON Ratio
			Tungsten (Watts)	Ballast (VA)			
BF-120	120	105-130	1000	1800	180	1.5	5:1
BF-208-277	208/240/277	185-305	1000	1800	180	1.5	5:1
BF-PV	120 or 208/240/277	105-305	1000	1800	180	1.5	5:1



C\_M

### M Series Locking Style/Industrial Grade with Surge Protection

The M series photocontrols are engineered to meet the demanding needs of Utility street lighting control. The heavy-duty thermal bi-metal switch in the M series produces a minimum 30-45 second time delay, eliminating unwanted off/on operations that could be caused by lightning, car headlights or other sudden changes in the ambient light. This feature makes the M series well suited for areas with high lightning activity. All M series controls are equipped with a 180 or 360 Joule Metal Oxide Varistor (MOV) to protect both the control and the luminaries against sudden surges in the line voltage, as well as a 1" CdS cell to maximize the photocontrol's useful life.

- 180 or 360 Joule MOV surge protection
- Heavy-duty thermal bimetal switch
- 30-45 second time delay
- UL and CSA listed
- ANSI C136.10 compliant
- Fail mode is ON

**UL** US LISTED  
128F  
PHOTOCONTROL  
E66375

**CSA**  
Certified  
LR27428

#### Selection Information

#### ANSI Standard Cap Colors

120V	Gray/Clear
208/240/277V	Maroon
120/208/240/277V	Blue
480V	Yellow

Catalog Number	Rated Volts	Range (Volts)	Load Rating		Surge Protection (Joules)	Turn ON (Fc)	OFF/ON Ratio
			Tungsten (Watts)	Ballast (VA)			
M-120	120	105-130	1000	1800	180	1.5	5:1
M-208-277	208/240/277	185-305	1000	1800	180	1.5	5:1
M-480*	480	420-530	1000	1800	180	1.5	5:1
M-PV	120 or 208/240/277	105-305	1000	1800	180	1.5	5:1
M-347**	347	310-380	1000	1800	180	1.5	5:1
MH-120*	120	105-130	1000	1800	360	1.5	5:1
MH-208-277*	208/240/277	185-305	1000	1800	360	1.5	5:1
MH-PV*	120 or 208/240/277	105-305	1000	1800	360	1.5	5:1

\* Not UL or CSA Listed

\*\* CSA Listed Only

### Electronic Photocontrols



C\_LM1000

### LM 1000 Time Off Lighting Control

The Lightmaster II time off lighting control enables you to turn lights on when you need them and off when you don't. It does this, consistently and accurately, by combining the operational simplicity of a traditional solid-state photocontrol with the sophisticated switching capabilities of a programmable electronic time clock. The Lightmaster II lighting control's unique design turns lights on at dusk, then off again at a field-selectable time later in the evening, when lighting is no longer necessary. If desired, it can also be set to turn lights back on again at a field-selectable time before dawn.

- Programmable
- Resets automatically after power outages
- 360 Joule MOV surge protection
- 2-5 second ON and OFF time delay
- Rain-tight / dust-tight housing
- ANSI C136.10 compliant
- Fail mode is ON

#### Selection Information

Catalog Number	Rated Volts	Range (Volts)	Load Rating		Surge Protection (Joules)	Turn ON (Fc)	OFF/ON Ratio
			Tungsten (Watts)	Ballast (VA)			
LM-1000	120/208/240/277	105-305	1000	1800	360	5.0	1.5:1

## 2000 Series Electronic/Heavy Duty

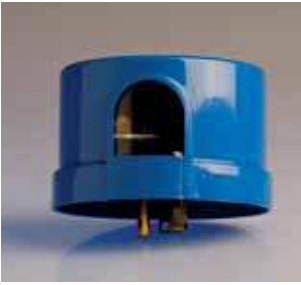

C\_2000

TE Connectivity's advanced technology 2000 Series provides a unique mix of low-cost, long-life and multi-volt operation for demanding Roadway Lighting applications. Like all of our Electronic controls, the 2000 Series utilizes our interlocking base/cap design for superior environmental protection. Its cost effective solid-state photoelectric control is designed for extra long life in demanding applications. The 2000 series control includes a non-drifting photo transistor and heavy duty relay, which ensures precise control for more than 8 years.

- Heavy duty utility grade electronic
- 30 Amp relay
- 180 or 360 Joule MOV surge protection
- 2-5 second ON and OFF time delay
- Non-drifting phototransistor
- Rain-tight / dust-tight housing
- ANSI C136.10 compliant
- Fail mode is ON
- 2100 series has inverse OFF/ON ratio

### Selection Information

Catalog Number	Rated Volts	Range (Volts)	Load Rating		Surge Protection (Joules)	Turn ON (Fc)	OFF/ON Ratio
			Tungsten (Watts)	Ballast (VA)			
2060-NPS	120	105-130	1000	1800	180	1.5 +/- 0.5	1.5:1
2060-VPS	120	105-130	1000	1800	360	1.5 +/- 0.5	1.5:1
2090-NPS	120/208/240/277	105-305	1000	1800	180	1.5 +/- 0.5	1.5:1

Note: Custom models can be configured based on chart below.

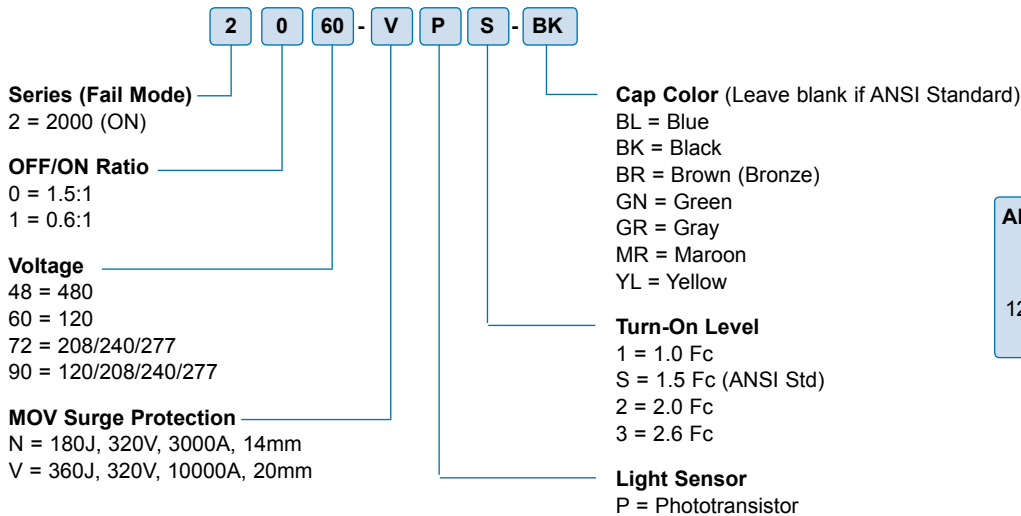



C\_3000

### 3000 Series Electronic/Heavy Duty/N.O. Contact

TE Connectivity's advanced technology 3000 Series provides a unique mix of long-life, multi-volt and fail OFF operation demanding roadway lighting applications. Like all of our electronic controls, the 3000 Series utilizes our interlocking base/cap design for superior environmental protection. The 3190 model utilizes a microprocessor in its design ensuring precise calibration for inverse ratio operation and allowing for user-defined factory programmable attributes including ON/OFF ratios, ON light levels and time delays.

- Heavy duty utility grade electronic
- 180 or 360 Joule MOV surge protection
- 2-5 second ON and OFF time delay
- Non-drifting phototransistor, optional IR filtered
- Rain-tight / dust-tight housing
- ANSI C136.10 compliant
- Fail mode is OFF
- 3100 series has inverse OFF/ON ratio

#### Selection Information

Catalog Number	Rated Volts	Range (Volts)	Load Rating		Surge Protection (Joules)	Turn ON (Fc)	OFF/ON Ratio
			Tungsten (Watts)	Ballast (VA)			
3090-NPS	120/208/240/277	105-305	1000	1800	180	1.5 +/- 0.5	1.5:1
3090-VFS	120/208/240/277	105-305	1000	1800	360	1.5 +/- 0.5	1.5:1

Note: Custom models can be configured based on chart below.

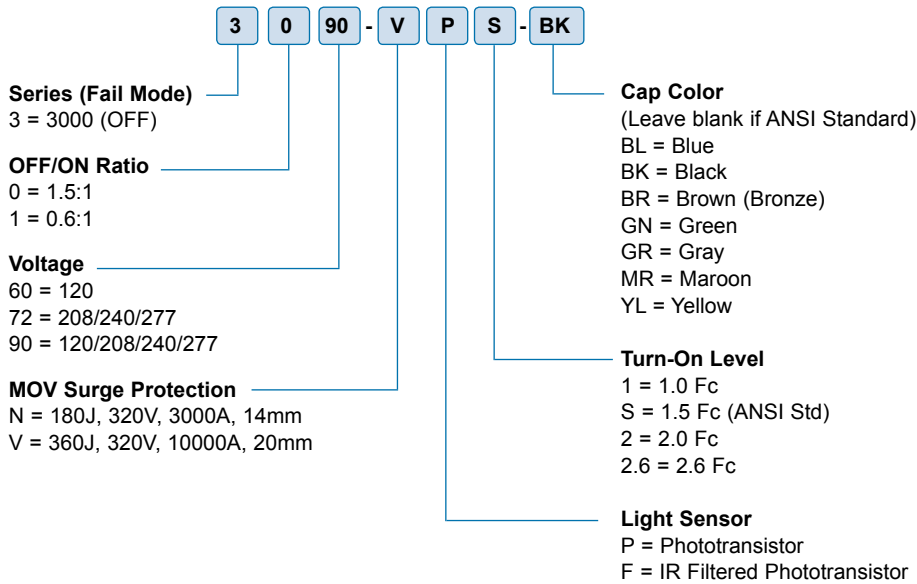

ANSI Standard Cap Colors	
120V	Gray/Clear
208/240/277V	Maroon
120/208/240/277V	Blue

## 6000 Series Electronic/Heavy Duty/Premium Grade



C\_6000

TE Connectivity's advanced technology 6000 Series provides a unique mix of low-cost, long-life and multi-volt operation for demanding Roadway Lighting applications. Like all of our Electronic controls, the 6000 Series utilizes our interlocking base/cap design for superior environmental protection and its expected life is far greater than 10 years. The newest member of the 6000 Series family, the 6190, utilizes a microprocessor in its design ensuring precise calibration for inverse ratio operation and allowing for user-defined factory programmable attributes.

- Long life, high reliability
- 30 Amp relay
- MOV surge protection
- Non-drifting phototransistor
- Instant ON / 2-5 second OFF time delay
- Rain-tight / dust-tight housing
- ANSI C136.10 compliant
- Fail mode is ON
- 6100 series has inverse OFF/ON ratio



### Selection Information

Catalog Number	Rated Volts	Range (Volts)	Load Rating		Surge Protection (Joules)	Turn ON (FC)	OFF/ON Ratio
			Tungsten (Watts)	Ballast (VA)			
6060-VPS	120	105-130	2000	1800	360	1.5	1.5:1
6090-VPS	120/208/240/277	105-305	2000	1800	360	1.5	1.5:1
6090-VPS-UL	120/208/240/277	105-305	1000	1800	545	1.5	1.5:1

Note: UL indicates a UL listed product

Note: Custom models can be configured based on chart below.

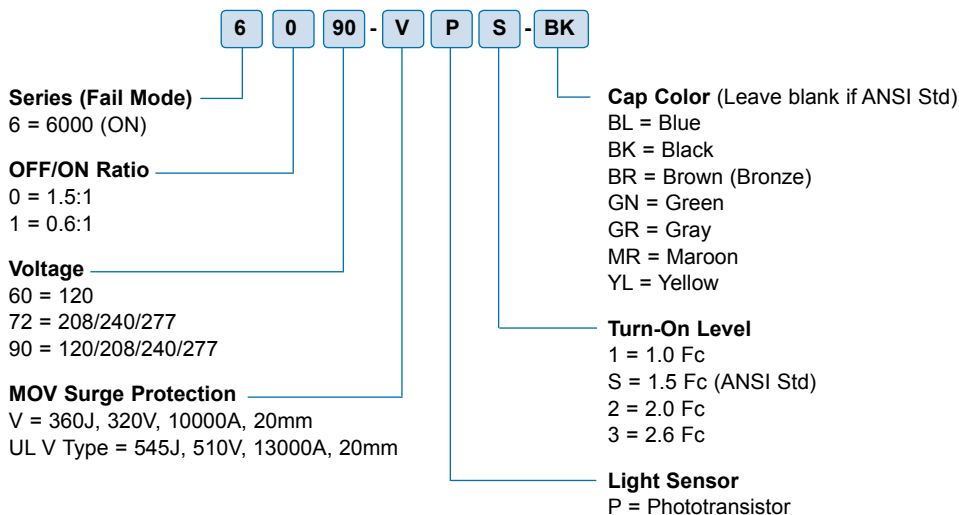

120V	Gray/Clear
208/240/277V	Maroon
120/208/240/277V	Blue





C\_7000

## 7000 Series Electronic/Heavy Duty/Utility Grade

TE Connectivity's advanced technology 7000 Series provides a unique mix of low-cost, long-life and multi-volt operation for demanding Roadway Lighting applications. Like all of our Electronic controls, the 7000 Series utilizes our interlocking base/cap design for superior environmental protection and its expected life is far greater than 10 years. Available as an option, the IR Filtered Phototransistor gives a human eye response along with long-term, drift-free light sensing.

- Long life, high reliability
- 30 Amp relay
- 480 Joule surge protection
- Non-drifting phototransistor, optional IR filtered
- Instant ON / 2-5 second OFF time delay
- Rain-tight / dust-tight housing
- ANSI C136.10 compliant
- Fail mode Is ON
- Standard pack 100 units that are in individual bags

### Selection Information

Catalog Number	Rated Volts	Range (Volts)	Load Rating		Surge Protection (Joules)	Turn ON (FC)	OFF/ON Ratio
			Tungsten (Watts)	Ballast (VA)			
7060-VPS	120	105-130	1000	1800	360	1.5+/-0.5	1.5:1
7090-VPS	120/208/240/277	105-305	1000	1800	360	1.5+/-0.5	1.5:1
7090-VPS-BK	120/208/240/277	105-305	1000	1800	360	1.5+/-0.5	1.5:1

Note: Custom models can be configured based on chart below.

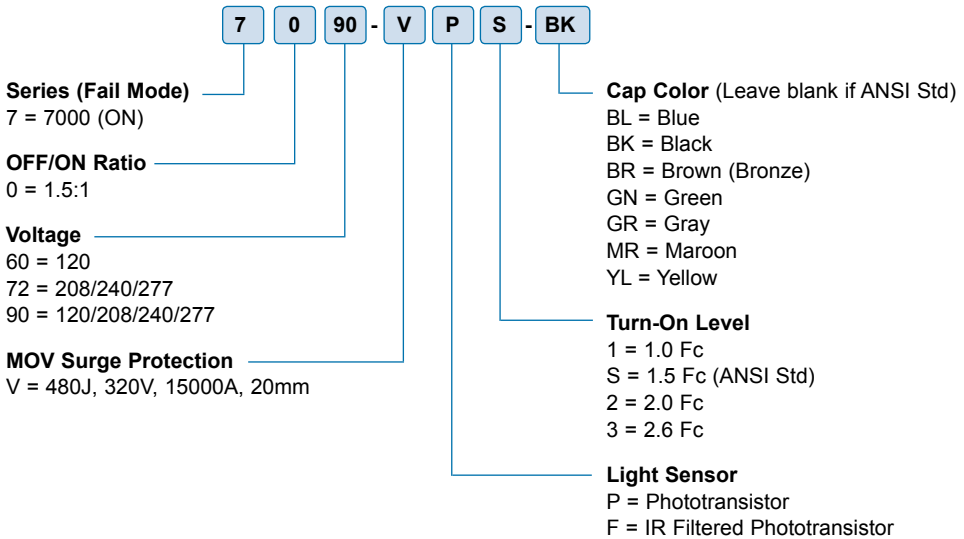

ANSI Standard Cap Colors	
120V	Gray/Clear
208/240/277V	Maroon
120/208/240/277V	Blue



C\_8000

## 8000 Series Electronic/Heavy Duty/Utility Grade

TE Connectivity's advanced technology 8000 Series provides a unique, durable, multi-volt control especially designed for twenty year operation. Like all of TE Connectivity's electronic controls, the 8000 Series utilizes our inter-locking base/cap design for superior environmental housing. High temperature base material, rated at a minimum 138°C, along with a UV stabilized, opaque housing ensure our control will last over 20 years without degradation.

TE uses a process of IR filtering a phototransistor which in turn gives a human eye response along with long-term, drift free light sensing for the life of the control.

- Multi-Volt Operation
- High-Temp Housing and Components
- 545 Joule MOV Standard
- Meets or exceeds ANSI C136.10

### Specifications

Physical:	Dimensions - approx. 3.26" (83mm) dia. x 1.77" (45mm) high (Not including contacts) Enclosure - designed to meet ANSI C136.10 Power consumption - less than 0.5 Watt at 120 VAC
Temperature:	Minus 40°C to plus 65°C at 96% RH
Control:	Exceeds 20,000 ON/OFF operations Solid State Switch Type
Relay Rating:	30 Amp
Load Rating:	1000 Watt Tungsten 1800 VA
Light Sensor:	Non-drifting phototransistor

### Selection Information

Catalog Number	Rated Volts (VA)	Range (Volts) (Joules)	Load Rating		Surge Protection	Turn ON	OFF/ON
			Tungsten (Watts) (FC)	Ballast Ratio			
8090-VFS	120/208/240/277	105-305	1000	1800	545	1.5	1.5:1

Note: Custom models can be configured based on chart below.

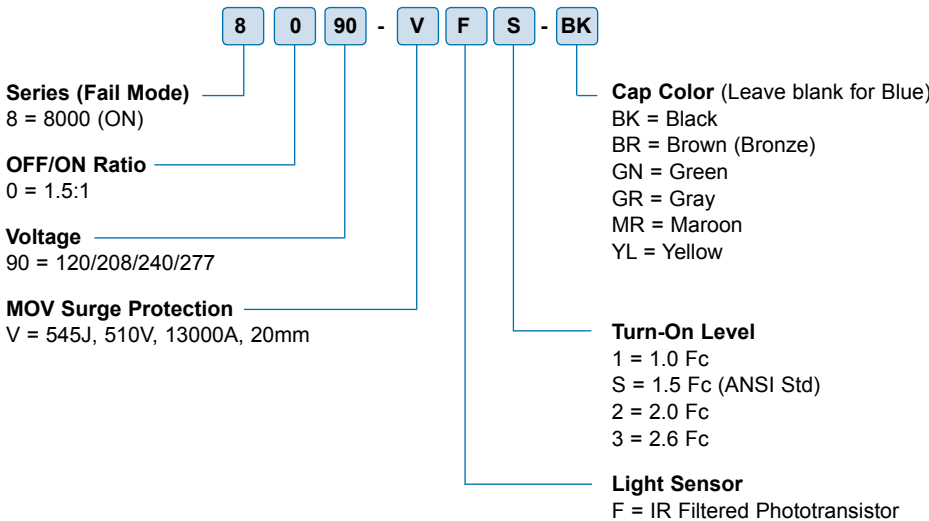



C\_SST

## SST Series Electronic/Heavy Duty with Time Delay

TE Connectivity's SST Series offers a low-cost and energy saving control for demanding lighting applications. The SST features a heavy-duty DC magnetic switch that provides high shock and vibration resistance, as well as a 20 - 40 second ON and OFF time delay which eliminates any chance of unwanted luminaire cycling caused by lightning, car headlights, or other sudden changes in ambient light. The SST's light sensor is a non-drifting phototransistor that ensures consistent and uniform switching over the life of the control.

- Energy saving inverse OFF/ON ratio
- 30 Amp relay / microprocessor controlled
- MOV surge protection
- Non-drifting phototransistor
- 20-40 second ON and OFF time delay
- Rain-tight / dust-tight housing
- ANSI C136.10 compliant
- Fail mode is ON



### Selection Information

Catalog Number	Rated Volts	Range (Volts)	Load Rating		Surge Protection (Joules)	Turn ON (Fc)	OFF/ON Ratio
			Tungsten (Watts)	Ballast (VA)			
SST-PV	120/208/240/277	105-305	1000	1800	180	1.5 +/- 0.5	0.6:1
SST-PV-IES	120/208/240/277	105-305	1000	1800	180	3.0 +/- 0.5	0.6:1
SST-PV-IES-UL	120/208/240/277	105-305	1000	1800	545	3.0 +/- 0.5	0.6:1
SST-FAA	120/208/240/277	105-305	1000	1800	180	35 +/- 0.5	1.5:1

Note: UL indicates a UL listed product

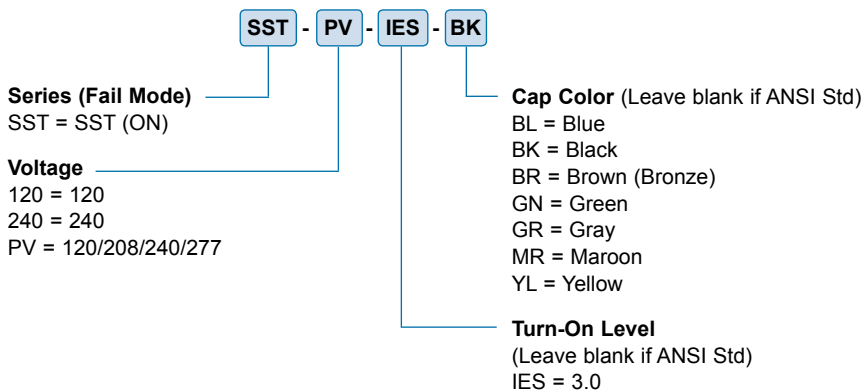

ANSI Standard Cap Colors	
120V	Gray/Clear
208/240/277V	Maroon
120/208/240/277V	Blue
480V	Yellow



C\_TimeClocks

## Time Clocks 24 Hour

The TC and PC series 24-hour time clocks offer a number of features and are the perfect choice for controlling HVAC systems, Pool/Spa Heaters and Filters, Fans/Motors/Pumps/ Blowers, Electric Fences, Conveyers or many other types of applications. The 24-hour dial accommodates 2 to 14 replaceable trippers for 1 to 7 on/off operations per day. The 24-hour clocks allow 1-1/2 hour minimum and 22-1/2 hour maximum ON or OFF time with a manual override lever to temporarily reverse switch operation without permanently disturbing the preset schedule. The time controls also feature a switch slide bar that assures positive switching, heavy-duty industrial type synchronous motors and heavy-duty terminals that accommodate #8 AWG wire. The optional skip-a-day feature (model TC-173) allows schedule to be omitted on any day or days of the week without permanently disturbing the preset schedule.

- Tamper proof enclosure
- All-steel mechanism
- 1-7 ON/OFF operations per day
- Manual override
- UL and CSA listed



E79611



### Selection Information

Catalog Number	Use	Volts (60 Hz)	Switch Rating Per Pole					Enclosure			
			Switch	Amps	Amps T	VA	HP	Type (NEMA)	Height (inches)	Width (inches)	Depth (inches)
TC-101	Indoor	120	SPST	40	40	690	1	1	7-27/32	4-9/64	2-15/16
TC-103	Indoor	120	DPST	40	40	690	1	1	7-27/32	4-9/64	2-15/16
TC-104	Indoor	208-277	DPST	40	40	690	1	1	7-27/32	5-9/64	2-15/16
TC-101R	Outdoor	120	SPST	40	40	690	1	3	9-5/8	5-3/8	3-11/16
TC-103R	Outdoor	120	DPST	40	40	690	1	3	9-5/8	5-3/8	3-11/16
TC-104R	Outdoor	208-277	DPST	40	40	690	1	3	9-5/8	5-3/8	3-11/16
PC-101R	Outdoor	120	SPST	40	40	690	1	3R	8-1/2	5-5/8	3-7/8
PC-103R	Outdoor	120	DPST	40	40	690	1	3R	8-1/2	5-5/8	3-7/8
PC-104R	Outdoor	208-277	DPST	40	40	690	1	3R	8-1/2	5-5/8	3-7/8

Note: Trippers Replacement Part X-2772



C\_Timers

## Interval Timers Spring Wound

Spring-wound interval timers are easily operated with a simple rotary knob and are available in three popular styles. These manually set time switches are interchangeable with standard toggle switches and turn circuits "OFF" at the end of a pre-set time period. Their simple 2-wire design also makes them easy to install in NEMA wall boxes. Typical applications include controlling electrical circuits for lighting, heating, ventilating and air-conditioning equipment, attic fans, heat lamps, whirlpools and saunas, as well as in conjunction with HVAC systems as a thermostat bypass.

- Easy to Install 2-Wire Design
- 20 Amp Rating at 120 VAC
- UL and CSA Listed
- SPST



E79611



### Selection Information

Catalog Number	Cycle Time	Style / Color	Wall Plate	NEMA Wall Box (Depth - inches)	Amps	Volts (AC)
FC-15M	15 min.	Brushed Aluminum	Included	3	10	250
FC-30M	30 min.	Brushed Aluminum	Included	3	10	277
FC-60M	60 min.	Brushed Aluminum	Included	3	7	125*

\* Tungsten



Photocontrols Sold Separately  
C\_AMR

## AMR Series

- Perfect for group control applications
- 30 Amp relay
- 3000 Watt rating per pole
- SPDT or DPST switching

### Selection Information

Model	Rated (Volts)	Range (Volts)	Ballast (VA)/Pole	Load Rating (Amps)	Switch	Switch Contacts
AMR3030.2-120V	120	105-130	3600	30	SPDT	1 NO/ 1 NC
AMR3030.2-240V	240	204-260	7200	30	SPDT	1 NO/ 1 NC
AMR3030.3-120V	120	105-130	3600	30	DPST	2 NO
AMR3030.3-240V	240	204-260	7200	30	DPST	2 NO

Note: 12" Lead wires



C\_Short\_Open\_Caps

## Shorting and Open Caps

SC, MC and NS caps provide a convenient and economical method to close or open the primary circuit with a NEMA locking type receptacle. Durable materials and gasket provide both long life and weatherproof protection. The MC-10 model also incorporates a 360-joule Metal Oxide Varistor (MOV) that protects the cap and the luminaries from transient line surges. Designating ANSI in the part number will provide you a unit with a stepped housing dictated in the latest ANSI C136.10 specification. This unique housing makes it easier for users to distinguish visually between a standard photocontrol and a shorting or open cap.

- Shorting and non-shorting models
- Optional surge protection



128F  
PHOTOCONTROL  
E66375

### Selection Information

Catalog Number	Circuit Type	Cap Color	Load Rating		Surge Protection (Joules)
			Tungsten (Watts)	Ballast (VA)	
SC-10A*	Shorting	Clear	1000	1800	-
SC-10ANSI**	Shorting	Black	1000	1800	-
MC-10	Shorting	Black	1000	1800	360
MC-10ANSI**	Shorting	Black	1000	1800	360
NS-10	Open	Maroon	1000	1800	-
NS-10ANSI**	Open	Red	1000	1800	-

\*UL Listed

\*\*ANSI C136.10-2006 Compliant



C\_AM

## AM Series

- Phosphor bronze contacts
- Thermal-set phenolic base
- UL Recognized component
- Voltage range: 120 - 480 VAC



E168962

### Selection Information

Catalog Number	Load Rating		Flange Diameter	Barrel Diameter	Receptacle Height (inches)	Overall Lead Length	Bracket (inches)		
	Ballast (VA)	Ballast (Amps)					Width	Depth	Height
AM-1-A	1800	15.0	2-9/16	1-3/8	1-1/2	9	2.0	3-1/2	5-1/2
AM-1-A-NB	1800	15.0	2-9/16	1-3/8	1-1/2	9	-	-	-
AM-2-A	1800	15.0	2-9/16	-	3-1/3	6	2.0	3-1/2	5-1/2
AM-2-A-NB	1800	15.0	2-9/16	-	3-1/4	6	-	-	-



C\_US30

## US-30 Starter

The US-30 starter is a universal starting aid designed to operate with most 3-wire HPS ballasts from 35 to 400 watts and with 55 or 100-volt arc tube lamps. This one starter does the job of dozens of different 3-wire starters. The US-30 starter is a state-of-the-art device that generates the spike required for lamp ignition, then discontinues the spike after lamp ignition to prevent damage to luminaries' components. The US-30's components are hermetically sealed to prevent damage from contaminants or adverse environmental conditions, and its wire leads are color coded for ease of installation and maintenance.

- Universal 3-wire design
- Hermetically sealed components
- Durable ABS housing
- Operates with 35 to 400 Watt HPS ballasts

### Selection Information

Catalog Number	Lead Connector	Lamp Voltage	Lamp Wattage
US-30	None	50 or 100	35-400



C\_OLC\_PL\_ACL

## OLC / PL / ACL Series

- Fast and simple to install
- For incandescent, CFL, LED, Halogen loads only
- Designed for outdoor and indoor use
- Fail Mode is ON

### Selection Information

Catalog Number	Rated Volts	Range (Volts)	Tungsten (Watts)	Load Rating CDs Cell (inch)
CPGI-ALR-PL-120S	120	105 - 130	150	1/8
CPGI-ALR-PL-120S-B	120	105 - 130	150	1/8
CPGI-ALR-OLC-5C	120	105 - 130	150	1/4
CPGI-ALR-ACL-11*	120	105 - 130	400	1/8

\* ACL controls are designed for incandescent loads only



# ASSET & WILDLIFE PROTECTION

## BUS Insulation & Wildlife Protection

HVBT High Voltage Busbar Insulating Tape (5-35 kV) . . . . .	238
BBIT/BPTM Insulating Busbar Tubing (5-35 kV) . . . . .	239
HVIS High Voltage Insulating Sheet (5-15 kV) . . . . .	240
RRBB Insulating Barrier Board . . . . .	241
HVBC Raysulate Electrical Insulator . . . . .	241

## Substations

BISG Bus Insulator Squirrel Guard . . . . .	242
BCAC Bushing Connection Animal Cover . . . . .	243
BCAC-IC Bushing Connection Inspection Cover . . . . .	244
BCIC Bus Connection Insulating Cover . . . . .	245
MVFT Medium Voltage Fusion Tape . . . . .	251
MVCC Medium Voltage Conductor Covers . . . . .	251

## Overhead

BCIC Raptor Protection Cover . . . . .	252
BCAC/BCIC Distribution Covers . . . . .	253
BCIC Recloser Insulating Covers . . . . .	254
BCIC-115-PH Transmission Flashover Protection . . . . .	255
MVLC Medium Voltage Line Cover (5-25 kV) . . . . .	255

## Contamination/Flashover Prevention

HVCE High Voltage Creepage Extenders . . . . .	257
HVCE-WA Wraparound High Voltage Creepage Extenders . . . . .	258
HVBS Booster Shed . . . . .	259
RRGS Guano Shield . . . . .	260



C\_HVBT

## HVBT High Voltage Busbar Insulating Tape (5-15 kV)\*

Raychem HVBT tape is an adhesive coated, high-voltage, heat-shrinkable, general-purpose tape for insulating straight and bent bars in retrofit applications where tubing cannot be used. In addition, HVBT easily insulates unusual connections and geometries in the factory or field.

HVBT tape is also ideal for protection against incidental/accidental bridging caused by birds and animals. HVBT may be suitable for higher voltage applications (see Ordering information #2 below). The HVBT adhesive layer fuses the tape layers but does not stick to bus or hardware, thus providing environmental sealing while allowing fast, easy removal.

HVBT tape may be used in applications up to 15 kV in accordance with ANSI/IEEE specifications and up to 36 kV in accordance with IEC specifications.

Rated to ANSI/IEEE C37.20-1987.

### HVBT tape dimensions

Catalog Number	Roll	
	W	L
HVBT-1-R-01 (B8)	1"	25 ft.
HVBT-2-R-01 (B4)	2"	25 ft.
HVBT-4-R-01 (B2)	4"	25 ft.

### Selection Information: dimensions in inches/feet (millimeters/meters)

Bus Width	Recommended Product	Bus Length Insulated per Roll
-----------	---------------------	-------------------------------



#### Rectangular busbar

1 (25)	HVBT-1-R-01 (B8)	2.5 (0.7)
2 (50)	HVBT-2-R-01 (B4)	3.3 (1.0)
3 (75)	HVBT-2-R-01 (B4)	2.2 (0.6)
4 (100)	HVBT-2-R-01 (B4)	1.6 (0.5)
6 (150)	HVBT-2-R-01 (B4)	1.0 (0.3)
8 (200)	HVBT-4-R-01 (B2)	1.6 (0.5)

Maximum thickness: 5/8 inch (15 mm)



#### Square busbar

1 x 1 (25)	HVBT-2-R-01 (B4)	4.0 (1.2)
2 x 2 (50)	HVBT-2-R-01 (B4)	2.0 (0.6)
3 x 3 (75)	HVBT-2-R-01 (B4)	1.3 (0.4)
4 x 4 (100)	HVBT-4-R-01 (B2)	2.0 (0.6)
6 x 6 (150)	HVBT-4-R-01 (B2)	1.3 (0.4)



#### Round busbar

0.5 (12)	HVBT-1-R-01 (B8)	5.0 (1.5)
1.0 (25)	HVBT-2-R-01 (B4)	5.0 (1.5)
2.0 (50)	HVBT-2-R-01 (B4)	2.5 (0.7)
3.0 (75)	HVBT-2-R-01 (B4)	1.5 (0.4)
4.0 (100)	HVBT-4-R-01 (B2)	2.5 (0.7)

### Ordering Information

- Select the appropriate catalog number for the application. Confirm selection with the following recommendations and HVBT tape dimensions:
  - HVBT-1-R is best for short lengths and small bus sizes.
  - HVBT-2-R is the most versatile width for general purpose use.
  - HVBT-4-R is useful for long lengths and larger bus sizes.
- HVBT may be suitable for applications with higher voltage than those listed. Please contact your TE Connectivity representative for more information.
- To environmentally seal the bus, order S-1251-50-300-1 or S-1251-25-300-4 sealant strips separately.
- Recommended application is to wrap the tape around the busbar using a two-thirds overlap.
- Bolted connections require two layers of tape.
- Standard package:
  - HVBT-1-R: 8 rolls/box
  - HVBT-2-R: 4 rolls/box
  - HVBT-4-R: 2 rolls/box
- Continuous operating temperature: 90°C
- Related test reports: UVR-8023, EDR-5154





C\_BBIT\_BPTM

## BBIT/BPTM Busbar Insulating Tubing (5-35 kV)\*

### Raychem BBIT (5-35 kV)

Heavy-wall tubing for use on straight or bent bars where maximum clearance reduction or 35 kV insulation is required.

### Raychem BPTM (5-25 kV)

Medium-wall tubing for use on straight or bent bars where some clearance reduction or 25 kV insulation is required. These heat-shrinkable tubes for straight and bent busbars are extremely flexible, allowing them to be easily positioned on busbars and quickly installed using a gas torch or oven. They have a high expansion ratio, so each size of tubing fits a range of busbar sizes. Both BBIT and BPTM tubing are ideal for original equipment assembly, and for retrofit applications where access to one end is available.

BBIT and BPTM tubings are also ideal for protection against accidental bridging caused by birds and animals.

### Selection Information: dimensions in inches (millimeters)

#### BBIT Tubing

Catalog Number	Busbar dimensions			Diameter as Supplied and Fully Recovered
	Rectangular Bar (bus width)	Square Bar (each side)	Round Bar (diameter min.-max.)	
<b>BBIT (5-35 kV)*</b>				
BBIT-25/10-A/U	0.5 (12)		0.50-0.70 (12-18)	0.98-0.39 (25-10)
BBIT-40/16-A/U	1.0 (25)		0.70-1.10 (18-28)	1.57-0.63 (40-16)
BBIT-65/25-A/U	2.0 (50)	1.0 (25)	1.10-1.55 (28-40)	2.56-0.98 (65-25)
BBIT-100/40-A/U	3.0 (75)	2.0 (50)	1.75-2.45 (44-62)	3.94-1.57 (100-40)
BBIT-150/60-A/U	4.0 (100)	3.0 (75)	2.60-3.60 (66-91)	5.91-2.36 (150-60)
BBIT-175/80-A/U	5.0-6.0 (125-150)	4.0 (100)	3.45-4.75 (88-121)	6.89-3.15 (175-80)

Catalog Number	Rectangular Bar		Square Bar		Round Bar		Diameter as Supplied and Fully Recovered
	5-15 kV	25 kV	5-15 kV	25 kV	5-15 kV	25 kV	
<b>BPTM (5-25 kV)*</b>							
BPTM-15/6-A/U	N/A	N/A	N/A	N/A	0.26-0.52 (7-13)	0.26-0.30 (7-8)	0.59-0.24 (15-6)
BPTM-30/12-A/U	.25-0.5 (12)		0.5 (12)	0.5 (12)	0.53-0.90 (14-23)	0.53-0.65 (14-16)	1.18-0.47 (30-12)
BPTM-50/20-A/U	1.0 (25)	1.0 (25)	1.0 (25)	N/A	0.90-1.35 (23-33)	0.90-1.10 (23-28)	1.97-0.79 (50-20)
BPTM-75/30-A/U	2.0 (50)	2.0 (50)	1.5 (38)	1.0 (25)	1.30-2.00 (33-51)	1.30-1.65 (33-42)	2.95-1.18 (75-30)
BPTM-100/40-A/U	3.0 (75)	3.0 (75)	2.0 (50)	1.5 (38)	1.75-2.75 (44-70)	1.75-2.30 (44-58)	3.94-1.57 (100-40)
BPTM-120/50-A/U	4.0-5.0 (100-127)	4.0 (100)	3.0 (75)	2.0 (50)	2.15-4.00 (55-102)	2.15-3.20 (55-81)	4.72-1.97 (120-50)
BPTM-175/70-A/U	6.0-7.0 (150-178)	5.0-6.0 (127-150)	4.0 (100)	3.0 (75)	3.20-5.50 (81-140)	3.20-4.40 (81-112)	6.88-2.75 (175-70)
BPTM-205/110-A/U	8.0 (200)	8.0 (200)	5.0 (127)	4.0 (100)	4.75-7.00 (120-178)	4.75-6.80 (120-174)	8.07-4.33 (205-110)
BPTM-235/130-A/U	12 (300)	10 (250)	6.0 (150)	6.0 (150)	5.70-8.45 (145-215)	5.70-8.07 (145-205)	9.25-5.12 (235-130)

#### Ordering/Application Information

- Select the appropriate catalog number. Confirm selection with bus dimensions.
- These products may be suitable for applications with higher voltages than those listed. Please contact your TE Connectivity representative for more information.
- Rectangular bus thickness range is 1/4 to 5/8 inch.
- Bolted connections require two layers of tubing or a fiber bolt pad.
- To environmentally seal the bus at each end of the BBIT tubing, order S-1251-50-300-1 or S-1251-25-300-4 sealant strip separately.
- Standard package:
 

BBIT-25/10-A/U: 65'/box	BBIT-150/60: 50'/box
BBIT-40/16-A/U: 60'/box	BBIT-175/80: 50'/box
BBIT-65/25 A/U: 50'/box	BPTM 235/132: 66'/box
BBIT-100/40: 50'/box	All other BPTM sizes: 50'/box

 BBIT and BPTM are also available in bulk spooled quantities.
- Related test reports:
  - BBIT-UVR-8136
  - UVR-8137
  - BPTM-UVR-8019
- Minimum continuous length is 15 feet (4.5 meters).

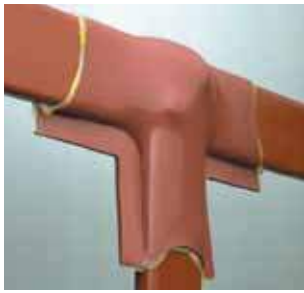

C\_HVIS

## HVIS High Voltage Busbar Insulating Sheet (5-15 kV)\*

Raychem HVIS is an adhesive coated, heat-shrinkable sheet that shrinks in two directions to tightly conform to complex shapes. It is ideal for insulating busbar tees, elbows, and other connections where tubing or tape cannot be used. HVIS may also be used in conjunction with Raysulate electrical insulating tapes and tubings or alone to help protect against accidental bridging caused by birds and animals.

Rated to ANSI/IEEE C37.20-1987.

### Selection Information: dimensions in inches/feet (millimeters/meters)

Catalog Number	Width	Length	Packaging
HVIS-05-(B3) NS	26 (660)	20 (508)	Sheet
HVIS-10-(B1) NS	26 (660)	33 ft (10 m)	Roll

Bus Width	Cut Size Needed	Number of Installations HVIS-05 Sheet	Per Sheet/Roll HVIS-10 Roll
-----------	-----------------	---------------------------------------	-----------------------------

#### T Connection

1 (25)	11 x 9 (275 x 225)	4	88
2 (50)	13 x 10 (325 x 250)	4	78
3 (75)	16 x 11 (400 x 275)	2	48
4 (100)	18 x 13 (450 x 325)	2	44
6 (150)	22 x 17 (550 x 425)	1	23

#### Elbow Connection

1 (25)	11 x 7 (275 x 175)	4	112
2 (50)	13 x 9 (325 x 225)	4	88
3 (75)	15 x 10 (375 x 250)	2	52
4 (100)	18 x 11 (450 x 275)	2	44
6 (150)	22 x 13 (550 x 325)	1	36

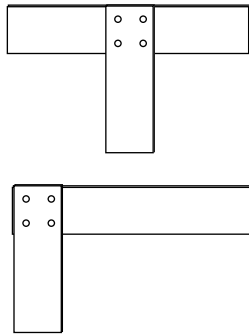

Catalog Number	Description	Std. Pack
----------------	-------------	-----------

#### Sheet (HVIS) Accessories

HVIS-Flat (B12)	36" flat bracket for clamping HVIS on straight runs	12 ea.
HVIS-Angle (B12)	Angle brackets for clamping HVIS at 90° angles	12 ea.
HVIS-Clamp (B25)	Spring clamps to hold brackets on HVIS.	25 ea.

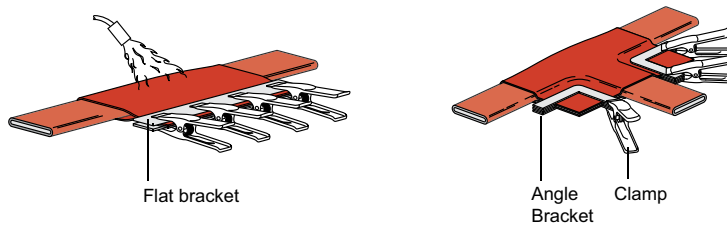

### Ordering/Application Information

- Select the appropriate catalog number. Confirm selection with dimensions.
- Busbars are assumed to be insulated to within 1 inch of the joint. Cut size should extend a minimum of 4 inches onto each leg of the joint before shrinking.
- The above table should be used as a guide only; experiment to confirm final cut size. Table is based on 5/8-inch bus thickness.
- To environmentally seal each leg of the bus, order S-1251-50-300-1 or S-1251-25-300-4 sealant strips separately.
- HVIS may be rated for applications up to 35 kV. Please contact your TE representative for more information.
- Standard package: HVIS-05: 3 sheets/box, HVIS-10: 1 roll/box
- Related test report: EDR-5175



C\_RRBB

## RRBB Interphase Insulating Barrier Board

Raychem RRBB board is a non-structural, interphase barrier for switchgear applications. The RRBB board is made from a homogeneous polymer and has excellent track resistance, especially following a power-arc. Easily fabricated into a shape, it produces less nuisance dust and less tooling wear than other boards.

### Applications

RRBB barriers protect switchgear cabinets against interphase flashovers that can be caused by contaminants, moisture and animals.

- Excellent tracking resistant properties provide longevity not found in typical polymers
- UV properties of the barrier boards are suitable for outdoor applications
- Extremely durable barrier boards resist damage from solvents, mechanical impact and general wear and tear
- Machining properties allow it to be cut and drilled for mounting without requiring special safety equipment
- Innovative cross-linking polymer withstands power-arcs without compromising its physical shape
- High temperature resistant material can be wiped clean after power-arc events resulting in no visible effects or surface damage

### Selection Information: dimensions in inches (millimeters)

Catalog Number	Width	Length	Thickness
RRBB-6-1.25Mx1.25M-(B3)	48 (1220)	48 (1220)	0.250 (6)
RRBB-2440/1220-6.2-BP	48 (1220)	96 (2440)	0.250 (6)

### Product Information

Related Test Report: EDR-5311



C\_HVBC

## HVBC Electrical Insulator Cable-to-Bus Connection Kit (5-15 kV)

The Raychem HVBC kit contains heat-shrinkable insulating tubing and sealant strips for insulating and environmentally sealing high-voltage in-line cable-to-busbar connections. For multiple cable connections, the kit also contains a heat-shrinkable sealing boot. The kit greatly simplifies field installation and eliminates the labor and skill needed for tape-and-putty methods.

When HVBC kits are used with TE Connectivity's high voltage terminations, the diameter build-up over the cable is minimal. This increases working space in cramped areas and allows up to four cable connections. HVBC may be used in applications up to 15 kV in accordance with ANSI/IEEE specifications, and up to 36 kV in accordance with IEC applications. Rated to ANSI/IEEE C37.20-1987.

### Selection Information: dimensions in inches (millimeters)

Catalog Number	Bus Width: 2-4 inches	Bus Width: 5-6 inches	Number of Cables	Cable Size Range (Min.-Max.)
HVBC-41		HVBC-61	1	#4-1000 kcmil
HVBC-42		HVBC-62	2	#4-1000 kcmil
HVBC-43		HVBC-63	3	#4-1000 kcmil
HVBC-44		HVBC-64	4	#4-1000 kcmil

### Accessory

Accessory	Description
BP-46	Bolt Pad

### Ordering/Application Information

1. Select the appropriate catalog number. Confirm selection with dimensions. One HVBC kit insulates one phase of an in-line cable-to-bus connection.
  - Maximum bolt length: 2 inches
  - Maximum busbar thickness: 5/8 inch
  - Maximum bare bus length: 9 inches
2. BBIT tubing, BPTM tubing, or HVBT tape, can be used to insulate the exposed busbar before installing the HVBC products.
3. Shielded cable must be terminated before installing HVBC products; use TE's HVT terminations.
4. Standard package: 3 kits/box
5. Related test report: EDR-5103

## Substation



C\_BISG

## BISG Bus Insulator Squirrel Guard

This isolation guard prevents animal-caused outages in electrical sub-station equipment.

### Reliable outage prevention

Raychem BISG discs have been successfully eliminating outages caused by squirrels, raccoons, opossums, cats, and other animals in substations for years. The guards are designed to allow for excellent visibility of switch blades and other components through the guard while providing mechanical resistance to power arcs and high winds.

### High performance material

Superior high voltage outdoor materials are used in the BISG guard design. The rugged, track resistant, UV-stable polymer ensures long-term performance even in the most extreme environmental conditions. Available in red or gray material.

### Faster, easier installation

The BISG-24 guard can be installed on energized equipment by one person. The new design incorporates a wedge device which makes hot-stick installations on vertical and horizontal mounted insulators quick and easy.

### Expanded size range

The BISG guard family fits insulator core diameters ranging from 1" (25 mm) through 5.0" (125 mm) from the factory. The "grill" type design allows easy field modifications for even larger diameters (see your local TE representative for details).

The BISG guard can also have its outside diameter reduced by trimming along the grill ribs. This will allow the guard to fit in tight phase-to-phase insulator applications.



BISG-60/115-03-HOT



BISG-24 energized install

### Selection Information: dimensions in inches (millimeters)

Catalog Number	Insulator Core Diameter Range	Overall Product Diameter	Color	Installation
BISG-60/115-02 (B10)	1.0-4.5 (25-115)	24	Red	De-energized
BISG-60/115-03-HOT (B10)	1.0-4.5 (25-115)	24	Red	Two stick (energized)
BISG-G-60/115-02 (B10)	1.0-4.5 (25-115)	24	Gray	De-energized
BISG-G-60/115-03-HOT (B10)	1.0-4.5 (25-115)	24	Gray	Two stick (energized)

### BISG-24

BISG-24-01 (B10)	2.5-5.0 (62-125)	24	Red	One stick (energized)
BISG-G-24-01 (B10)	2.5-5.0 (62-125)	24	Gray	One stick (energized)

*\*Overall product diameter can be trimmed down to 16" diameter*

### Ordering/Application Information

- Standard package: 10 BISG-60/115-02 | 10 BISG-24-01 assemblies per box.  
(One BISG will install on one insulator).
- Related test report: EDR-5310, EDR-5517-Bus Insulator Squirrel Guard (BISG-24-01).



**BCAC-5D/8**  
C\_BCAC

## BCAC Bushing Connection Animal Cover

These insulating covers are designed to prevent animal caused outages on bushings ranging from 15 to 35 kV. They fit a wide range of bushing sizes and are suitable for substation and distribution applications.

### Reliable Outage Protection

TE's Raychem insulating covers have been successfully eliminating outages from all types of animals for years. These covers have been designed to provide the same great protection with enhanced features.

### Fast and Versatile Installation

These BCACs are fast and easy to install. No trimming is required and they fit a wide range of bushing skirt diameters (see chart below). If needed, they can be installed on energized equipment as well. The feathered edges of these covers allow for conductor exits in both vertical and horizontal directions. These same edges act as thermal scan sites for true temperature evaluation of the covered hardware.

### High Performance Material

Superior high-voltage outdoor materials are used in the BCAC cover design. The rugged, non-tracking, UV-resistant polymer ensures long-term performance even in the most extreme environmental conditions.

### Selection Information: dimensions in inches (millimeters)

Catalog Number	Max. Shed Diameter	Cover Height	Color
BCAC-5D/8 (B12)	4.8 (122)	8.0 (203)	Red
BCAC-7D/10 (B6)	6.8 (172)	10.5 (266)	Red
BCAC-8D/14 (B6)	8.0 (203)	14.0 (355)	Red
BCAC-G-5D/8 (B12)	4.8 (122)	8.0 (203)	Gray
BCAC-G-7D/10 (B6)	6.8 (172)	10.5 (266)	Gray
BCAC-G-8D/14 (B6)	8.0 (203)	14.0 (355)	Gray



**BCAC-8D/14**



**BCAC-BYPASS**

### Ordering/Application Information

- Standard package: 12 or 6 units per box, depending on size of cover. (One BCAC will install on one insulator.)
- Related test reports: EDR-5339, UVR-8209

Catalog Number	Max. Shed Diameter	Cover Height	Color
BCAC-BYPASS-01 (B6)	6.8 (172)	10.6 (266)	Red
BCAC-BYPASS-02 (B6)	8.0 (203)	14.0 (355)	Red

The BCAC covers are also kitted for voltage regulator applications. The kit includes two bushing covers and a center arrester cover.



**BCAC-IC-8D/18**  
C\_BCAC\_IC

## Raychem BCAC-IC Bushing Connection Inspection Substation Cover

This insulating cover is designed to prevent animal caused outages on breaker and transformer bushings ranging from 15 to 35 kV.

### Fast and Versatile Installation

The cover is easily installed around bushings and connections by wrapping the double hinged design around the insulator's top skirt and snapping it in place with a robust latching mechanism. The cover allows conductors to exit from both the top and side interfaces without the need to trim the cover. The design allows for visible inspections of oil fill levels on transformer bushings as well.

### High Performance Material

Superior high voltage outdoor materials are used in the BCAC cover design. The rugged, non-tracking, UV resistant, high temperature polymer ensures long-term performance even in the most extreme environmental conditions.

#### Selection Information: dimensions in inches (millimeters)

Catalog Number	Std. Pack	Color	Insulator Core Range	Insulator Shed Range	Cover Size
BCAC-IC-7D/12 (B6)	6	Red	3.0-4.87 (76-124)	3.75-7.00 (95-178)	7.00 (178) dia, 12 (305) ht
BCAC-IC-8D/18 (B6)	6	Red	3.5-6.25 (90-160)	4.00-8.00 (100-200)	8.00 (200) dia, 18 (455) ht
BCAC-G-IC-7D/12 (B6)	6	Gray	3.0-4.87 (76-124)	3.75-7.00 (95-178)	7.00 (178) dia, 12 (305) ht
BCAC-G-IC-8D/18 (B6)	6	Gray	3.5-6.25 (90-160)	4.00-8.00 (100-200)	8.00 (200) dia, 18 (455) ht

#### Ordering/Application Information

1. Related test reports: EDR-5514, UVR-8209

The BCAC-IC covers are also kitted for voltage regulator applications. The kit includes two bushing covers and a center arrester cover.

#### Selection Information: dimensions in inches (millimeters)

Catalog Number	Max. Shed Diameter	Cover Height	Color
BCAC-IC-BYPASS-01 (B1)	7.0 (178)	12.00 (305)	Red



C\_BCIC

## BCIC Bus Connection Insulating Covers

Raychem BCIC covers are designed to protect energized conductors or busbars from flashovers due to contact from birds, squirrels and other wildlife. BCIC parts are made from a UV stable, track resistant, high performance TE's Raychem material to ensure years of reliable service.

A variety of different shapes and sizes are available to cover circuit breaker bushings, bus standoff insulators, capacitors, transformer bushings, voltage regulators, potential transformers and more.

Installation can be made quickly in the field by trimming the entry and exit holes to the required dimensions. The BCIC covers can be re-entered for other maintenance needs and then reused, thus lowering overall lifetime costs.

### Selection Information: dimensions in inches (millimeters)

#### Bushing Covers

#### Installed Product

#### Hardware Configuration



BCIC-4411 (B3)

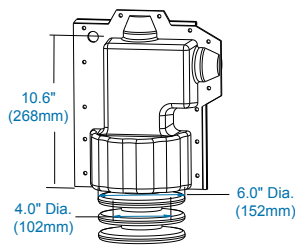

Note: 4" (100mm)  
Bottom Port Opening

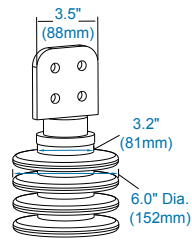

Uses 13 BCIC Latches



BCIC-SG-101-H2 (B3)

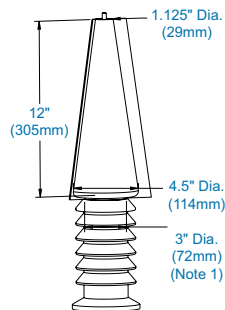

Note: Bottom and Top Opening Uses 5 BCIC Latches

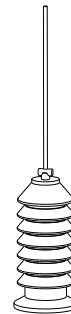

BCIC-9D/19-3 (B3)

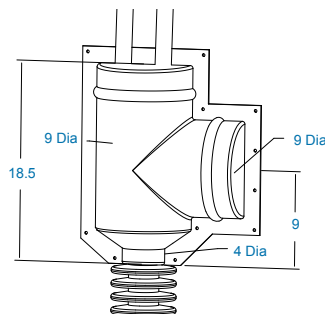

Uses 11 BCIC Latches

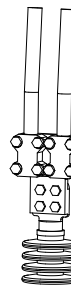

Bushing Covers

Installed Product

Hardware Configuration

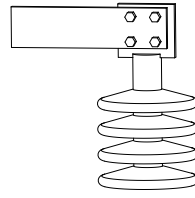
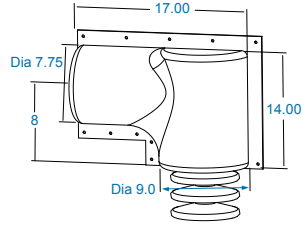

BCIC-10D/18-3 (B3)

Uses 11 BCIC Latches

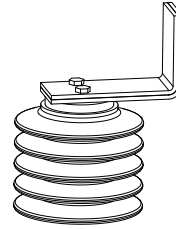
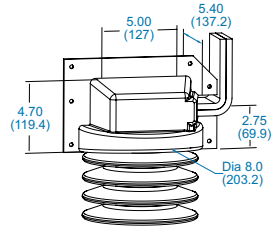

BCIC-8D/6-3 (B3)

Uses 6 BCIC Latches

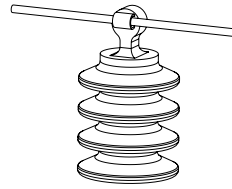
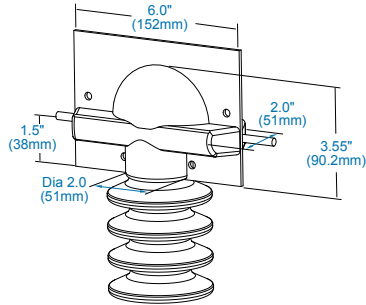
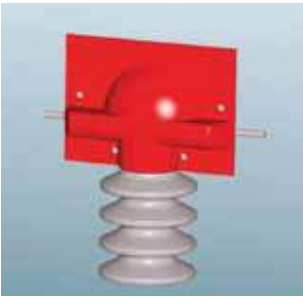

BCIC-3D/6-3 (B3)

Uses 4 BCIC Latches

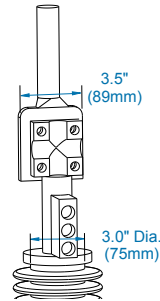
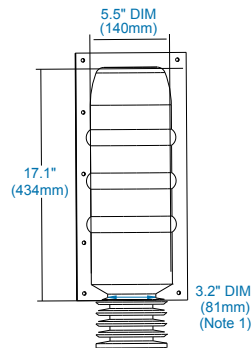

BCIC-5.5D/16 (B3)

Uses 7 BCIC Latches



Bushing Covers

Installed Product

Hardware Configuration

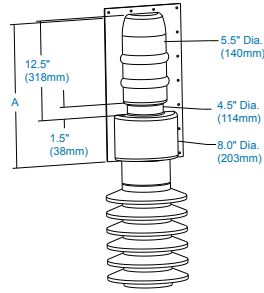

BCIC-8D/15H0 (B3)  
BCIC-8D/18-H0 (B3)

Dim. A = 16.2 (411)  
Dim. A = 19.2 (488)

Uses 10 BCIC Latches

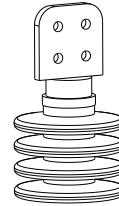
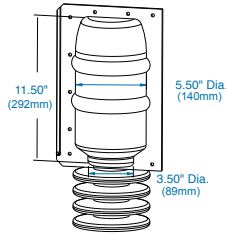

BCIC-5.5D/11 (B3)

Bushing Range Dia. 2-3.5  
Note: No Opening

Uses 9 BCIC Latches

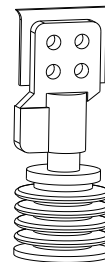
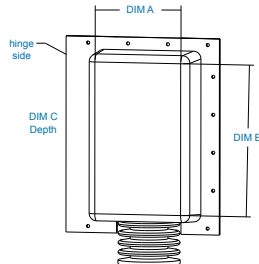

	Dim A	Dim B	Dim C	
BCIC-12/12/5-H (B3)	12 (305)	12 (305)	5 (127)	Uses 12 BCIC Latches
BCIC-14/19/6-U (B3)	14 (356)	19 (483)	6 (152)	Uses 16 BCIC Latches
BCIC-24/11/12-U (B3)	11 (279)	24 (610)	12 (304)	Uses 16 BCIC Latches
BCIC-4/12/4-H (B3)	4 (102)	12 (305)	4 (102)	Uses 12 BCIC Latches
BCIC-7/12/7-H (B3)	7 (178)	12 (305)	7 (178)	Uses 12 BCIC Latches
BCIC-4/16/4-H (B3)	4 (102)	16 (406)	4 (102)	Uses 12 BCIC Latches

Note: Must be field cut.

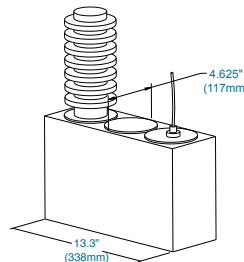
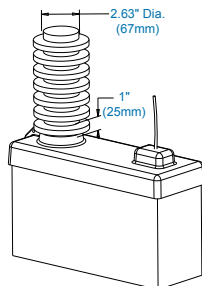
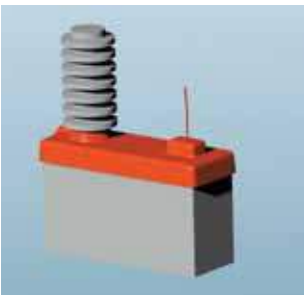

BCIC-0270-SCE (B3)

Note: Single Bushing  
Capacitor Cover

Uses 2 BCIC Latches

Bushing Covers

Installed Product

Hardware Configuration

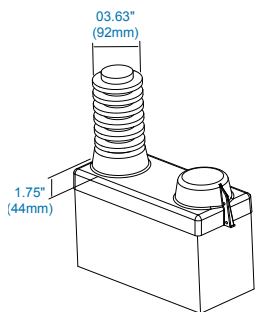

**BCIC-0370-SCE (B3)**

Note: Single Bushing Capacitor Cover

Uses 2 BCIC Latches

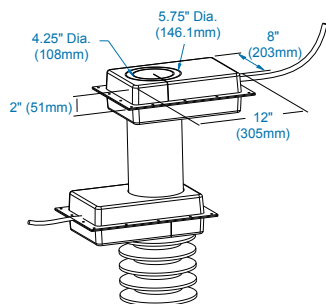

**BCIC-8/12/2 (B3)**

Note: Field trimmed part

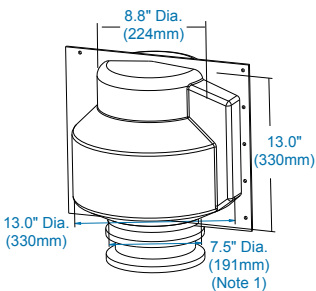

**BCIC-13D/13-H0 (B3)**

Note: No Opening Must Be Field Cut

Uses 10 BCIC Latches

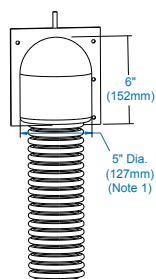

**BCIC-5D/6 (B3)**

Note: No Opening Must Be Field Cut

Uses 5 BCIC Latches

Bushing Covers

Installed Product

Hardware Configuration



BCIC-4D/4 (B3)

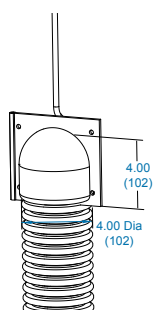

Uses 5 BCIC Latches

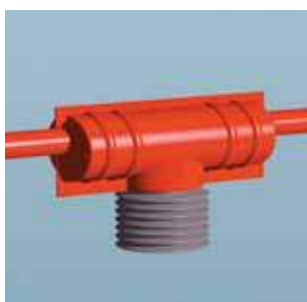

BCIC-7.5D/18-3 (B3)

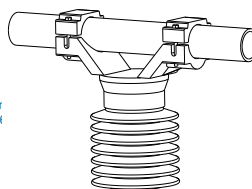
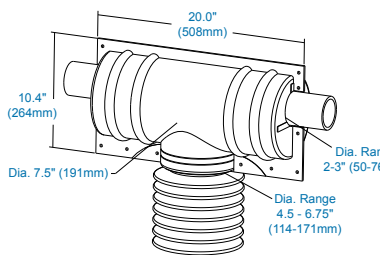

Bus Bar Dia. 2-3 (50-75)  
Angle Bus Double 3 (75)

Uses 8 BCIC Latches



BCIC-SG-201 (B3)

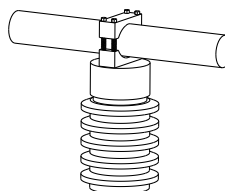
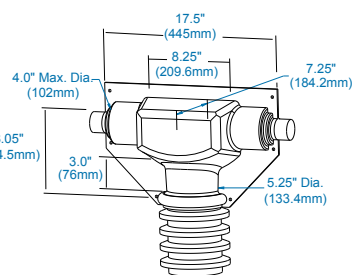

Max. Bus Bar Dia. 4 (100)

Uses 10 BCIC Latches

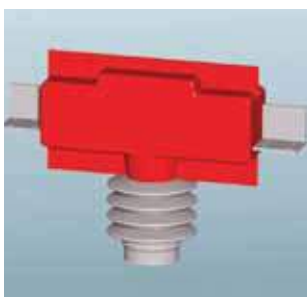

BCIC-TR205-L (B3)

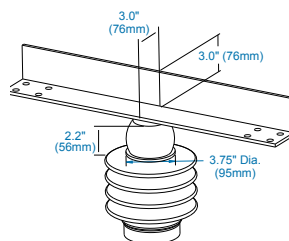
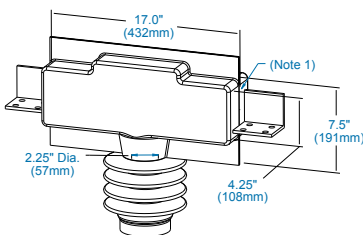

Note: No Opening  
Must Be Field Cut

Uses 10 BCIC Latches

Bushing Covers

Installed Product

Hardware Configuration

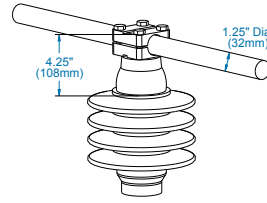
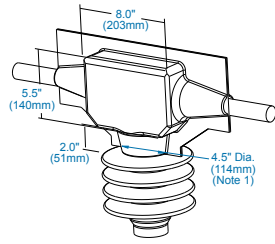

**BCIC-TR205-R (B3)**

Note: 4.5 (114) Dia.  
Bottom Port Opening

Uses 10 BCIC Latches

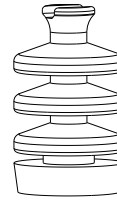
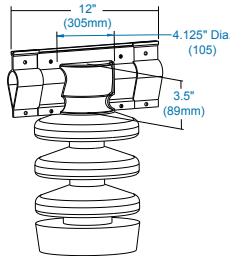

**BCIC-3212-01 (B3)**

Note: Bottom Port Has Opening Uses 8 BCIC Latches

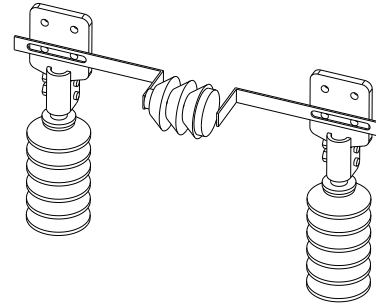
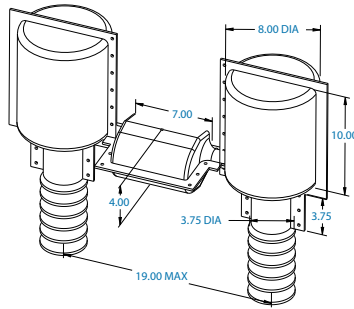
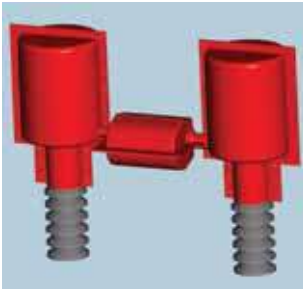

**BCIC-BYPASS (B1)**

Note: 3.75 (95) Dia.  
Bottom Port Opening

Uses 60-8" Long Tywraps

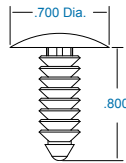

**BCIC-LATCH (B250)**

Std. Pack = 250 Latches or 1000 Latches



C\_MVFT

## MVFT Medium Voltage Fusion Tape

Raychem Medium Voltage Fusion Tape (MVFT) is a self amalgamating tape that provides insulation enhancement and protection against accidentally induced discharge. MVFT tape is designed to combine the integrity of a silicone polymer with the versatility of a wraparound product.

### Fast and Versatile Installation

MVFT tape is quick and easy to install. Upon application the tape amalgamates the over-lapped layers together, producing a complete seal. A single layer of MVFT tape, two-thirds overlapped, will provide AC voltage withstand (flashover protection) to at least 15 kV increasing to 35 kV if a second layer is applied. Although MVFT tape will stick to itself and other insulating materials, it will not adhere to metal or porcelain allowing easy removal for maintenance.

### Features

MVFT tape is compatible with all other products in the Raysulate MV Insulation Enhancement System. This fusion tape is suitable for both Indoor and outdoor use. MVFT tape exhibits non-tracking properties and possesses a continuous operating temperature up to 90°C.

### Applications

MVFT tape offers a simple and effective solution to the problems of retrofit insulation of busbars particularly where existing equipment cannot be dismantled. It can be used for indoor and outdoor applications and is easily installed over a wide variety of shapes including complex connections.

### Selection Information: dimensions in inches (millimeters) / yards (meters)

Catalog Number	Color	Supplied		Std. Pack
		Width	Length	
MVFT-G-2-12(B4)	Gray	2 (50)	12 (11)	4 Rolls

### Product Information

EDR-5465 Medium Voltage Fusion Tape Qualification Report



C\_MVCC

## MVCC Medium Voltage Conductor Covers for Outage Prevention

Raychem Medium Voltage Conductor Covers (MVCC) provide high quality electrical insulation for substation leads and jumpers. These covers are made from a non-tracking silicone material that is suitable for harsh medium voltage outdoor environments. MVCC covers are split for easy installation. The MVCC's flexibility allows installation on tight bends which makes it ideal for substation applications. These covers are designed to protect energized conductors from flashovers due to contact from birds and animals. The MVCC is suitable for applications up to 25 kV phase to ground. They are currently available in four sizes that will fit conductors with diameters ranging up to 1.75 inch.

### Selection Information: dimensions in inches (millimeters) / feet (meters)

Catalog Number	Conductor Diameter		Color	Supplied Length
	Use Range			
MVCC-10/.40 (B100)	up to .450 (11)		Red	2 pieces @ 50 (15.24)
MVCC-G-10/.40 (B100)	up to .450 (11)		Gray	2 pieces @ 50 (15.24)
MVCC-19/0.750 (B50)	.50-.75 (12-19)		Red	2 pieces @ 25 (7.6)
MVCC-G-19/0.750 (B50)	.50-.75 (12-19)		Gray	1 piece @ 25 (7.6)
MVCC-25/1.0 (B25)	.75-1.125 (19-28)		Red	1 piece @ 25 (7.6)
MVCC-G-25/1.0 (B25)	.75-1.125 (19-28)		Gray	6 pieces @ 4 (1.2)
MVCC-45/1.75 x 4 (B24)	1.125-1.75 (28-44)		Red	6 pieces @ 4 (1.2)
MVCC-G-45/1.75 x4 (B24)	1.125-1.75 (28-44)		Gray	6 pieces @ 4 (1.2)

### Product Information

Related Test Report: EDR-5461 Medium Voltage Conductor Cover Electrical Testing

**BCIC-G-HZ-795-01**

## BCIC Raptor Protection Cover Insulating Covers

These hot-stickable insulating covers are designed to prevent raptor caused outages on medium voltage distribution lines. This family of products fits a variety of polymeric and porcelain insulator configurations— including pin type insulators, horizontal post insulators and dead end insulators.

### Reliable Outage Protection

TE's Raychem insulating covers have been successfully eliminating outages from all types of animals for years. These covers have been designed to provide the same great protection with enhanced features.

### Fast and Versatile Installation

These BCIC Raptor protection covers use a patented bimaterial design to allow for hot-stick installations. The main covers and extension arms are built with rigid clips to provide a reliable mechanical hold. Up to 10 feet of coverage on conductor sizes ranging from #2 to 795 can be achieved when one cover and two arms are installed together. The arms are designed to nest over vibration dampers. The flexible covers allow conductors to exit at up to 30 degree angles from any axis.

### High Performance Material

Superior high voltage outdoor materials are used in the BCIC cover design. The rugged, track resistant, UV resistant polymer ensures long-term performance even in the most extreme environmental conditions.

**BCIC-G-PIN-795-01**

C\_BCIC\_Pro\_Cover

### Selection Information: dimensions in inches

Catalog Number	Conductor Application	Cover Range	Length	Std. Insulator Type/ ANSI	Pack
BCIC-G-PIN-556-01 (B6)	Porcelain PIN	#6-556	42	55-2, 55-3, 55-4, 55-5	6
BCIC-G-SMPIN-795-01 (B6)	Porcelain PIN	#6-795	42	55-2, 55-3, 55-4, 55-5	6
BCIC-G-PIN-795-01 (B6)	Porcelain PIN	#6-795	32	55-5, 55-6, 55-7, 56-1, 56-2, 56-3	6
BCIC-G-DPIN-795-01 (B6)	Double Porcelain PIN	#6-795	41	55-5, 55-6, 55-7, 56-1, 56-2, 56-3	6
BCIC-G-DPIN-556-01 (B6)	Double Porcelain PIN	#6-556	42	55-2, 55-3, 55-4, 55-5	6
BCIC-G-DSMPIN-795-01 (B6)	Double Porcelain PIN	#6-795	42	55-5, 55-6, 55-7, 56-1, 56-2, 56-3	6
BCIC-G-HZ-795-01 (B6)	Horizontal Post	#6-795	29	Polymeric	6
BCIC-G-HZ-795-XL (B6)	Horizontal Post	#6-795	41	Polymeric	6
BCIC-G-HZPOR/3.5D-795-01 (B6)	Horizontal Post	#6-795	29	Porcelain >35kV	6
BCIC-G-HZPOR/4.5D-795-01 (B6)	Horizontal Post	#6-795	29	Porcelain 25 to 35kV	6
BCIC-G-PIN-556/55-01 (B6)	Line Post	#6-556	55	Polymeric	6
BCIC-G-POR-228-795-01 (B6)	Line Post	#6-795	55	Porcelain 7-9 inch diameter	6
BCIC-G-DE/CL-01(B6)	Dead End	#6-795	27	Conductor	6
BCIC-G-ARM-48-01 (B12)	Extension ARM	#6-795	48	Conductor	12
BCIC-G-ARM-24-01 (B12)	Extension ARM	#6-795	24	Conductor	12

### Product Information

Related Test Report: EDR-5369 Raptor Protection Cover (BCIC-795) Mechanical/Electrical Evaluation  
EDR-5311 Rigid Red Barrier Board Qualification  
EDR-5314 EMMAQUA Testing of BCIS



**BCAC-G-5D/8-01**  
**BCAC-G-AR-5D-2**



**BCAC-G-4D/13-2**



**BCAC-G-CUTOUT-100-01**  
 C\_BCAC\_Dis\_Cover

## BCAC | BCIC

### Distribution Covers for Animal Protection

These Raychem insulating covers are designed to prevent raptor caused outages on distribution equipment ranging from 15 to 35 kV. Covers are available for terminations, reclosures, lightning arresters, and fuse cutouts.

#### Transformer Bushing

The BCAC-G-4D/13-2 covers a wide variety of termination sizes. The cover is easily installed on top of the first termination skirt. No trimming is required and the cover fits terminations ranging in size from #1 to 750 kcmil. Extensive testing has ensured that the cover will not damage or deteriorate the terminations.

#### Fast and Versatile Installation

These BCACs are fast and easy to install. No trimming is required and they fit a wide range of bushing skirt diameters. If needed, they can be installed on energized equipment as well. The feathered edges of these covers allow for conductor exits in both vertical and horizontal directions. These same edges act as thermal scan sites for true temperature evaluation of the covered hardware.

#### Lightning Arresters

Distribution surge arrester caps protect against unwanted animal and bird outages. The unique design covers the first skirt which improves the level of protection. The cap is easily installed and attaches to both the stud and the conductor so that it will stay secure even in high winds. Three different covers are available.

#### Fuse Cutouts

The BCAC-G-CUTOUT hot-stickable insulating cover is designed to protect fused cutout switch applications up to 25 kV. The unique omega shaped attachment area easily clips onto the cutout insulator between the first and second skirt. The insulated conductor is captured securely as well to ensure retention even in high winds. Two different covers are available for 100 and 200 amp applications.

#### High Performance Material

Superior high voltage outdoor materials are used in all of these BCIC cover designs. The rugged, track resistant, UV resistant polymer ensures long-term performance even in the most extreme environmental conditions.

#### Selection Information: dimensions in inches (millimeters)

Catalog Number	Hardware
BCAC-G-4D/13-2 (B18)	Terminations
BCAC-G-5D/8-01 (B12)	Transformer Bushing
BCAC-G-AR-5D-2 (B24)	Ohio Brass Arrester
BCAC-G-AR-4D-2 (B24)	TE Arrester
BCAC-G-AR-3.75D-2 (B24)	Cooper Arrester
BCAC-G-CUTOUT-100-01 (B12)	Fuse Cutout Switch (100 AMP) Porcelain Style
BCAC-G-CUTOUT-200 (B3)	Fuse Cutout Switch (200 AMP) Porcelain Style
BCAC-G-CUTOUT-100-P-B12	Fuse Cutout Switch (100 AMP) Polymeric Style



C\_BCIC\_Recloser

## BCIC Recloser Insulating Covers

Raychem insulating covers are designed to prevent animal electrocution and related outages on reclosers operating from 15 kV to 35 kV. There are numerous cover designs available to fit a wide variety of reclosers. TE Raychem also offers tubing and line hose to insulate leads as well as BCAC covers to protect lightning arresters on recloser units.

### Fast and Versatile Installation

The one piece hinged design is easily and quickly installed around the top skirts and secured using the supplied push pins to ensure years of reliable service. The cover can be re-entered for maintenance needs and then reused, thus lowering overall lifetime costs.

### Selection Information: dimensions in inches (millimeters)

Catalog Number	Height (A)	Max. Skirt (B)	Fits Recloser Type
BCIC-G-Reclosercover (B6)	12.4 (315)	7.8 (198)	Cooper
BCIC-G-Recloser-100 (B6)	15.4 (390)	6.75 (171)	ABB
BCIC-G-Recloser-200 (B6)	14.5 (368)	8.5 (216)	Siemens

Note: Specialty kits are also available that include BPTM and MVCC. Available in red or gray.

### Product Information

Related Test Report: EDR-5369 Raptor Protection Cover (BCIC-795) Mechanical/Electrical Evaluation  
 EDR-5311 Rigid Red Qualification  
 EDR-5314 EMMAQUA Testing of BCIS

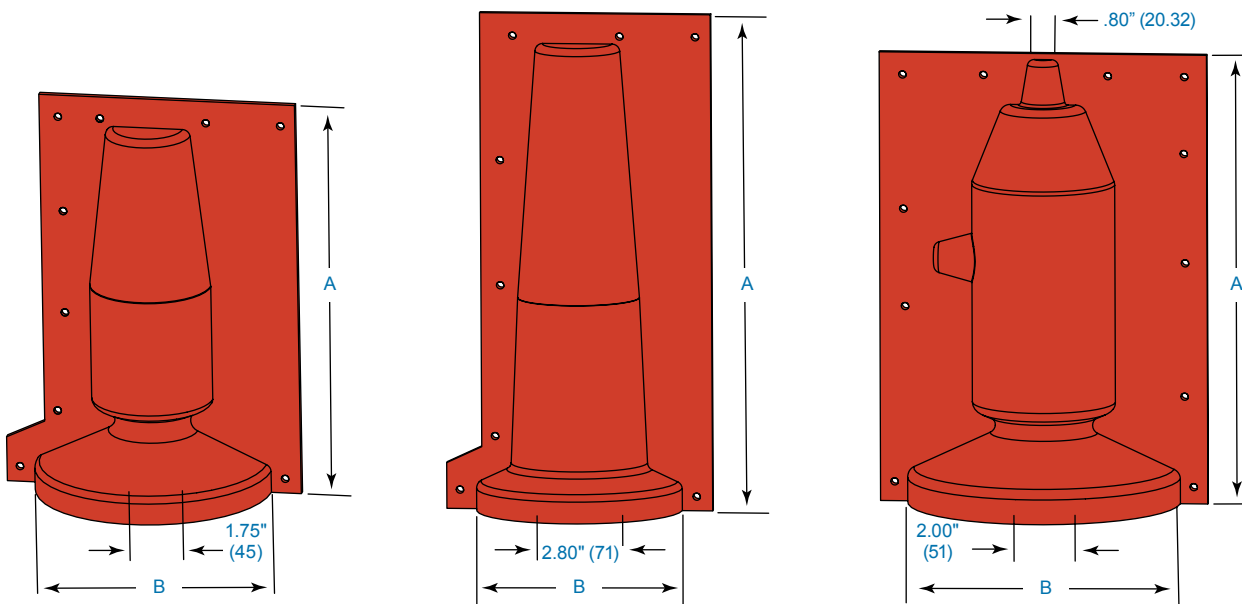

BCIC-RecloserCover (B6)  
 BCIC-G-RecloserCover (B6)

BCIC-Recloser-100 (B6)  
 BCIC-G-Recloser-100 (B6)

BCIC-G-Recloser-200 (B6)





C\_BCIC\_115

## BCIC-115-PH Transmission Flashover Protection Cover

The Raychem BCIC-115-PH insulating cover provides protection from raptor induced flashovers on 115 kV transmission lines. Cover is made out of the same thick BCIS material and can be used on both porcelain disc and polymeric insulator designs. The seven foot long body and bolt locking system can be used on energized or de-energized installations. Unique design allows the cover to rest on the lowest insulator for porcelain I string designs. In polymeric designs, the cover rests on a bolted collar on top of the lowest portion of the insulator string. The collar is made from robust BCIS material. The superior high-voltage material is made from a rugged, non-tracking, UV-resistant, high temperature polymer ensuring long-term performance even in the most extreme environmental conditions.

### Selection Information: dimensions in inches (millimeters)

Catalog Number	Part Number	Length	Height	Insulator Range	Applications
BCIC-115-PH (B1)	111371-000	74 (1879.6)	15 (381)	9-12 (229-305)	Main Cover
BCIC-Collar-50/280-5-BP	471716-000	—	—	—	Adapter collar for polymeric installations



C\_MVLC

## MVLC Medium Voltage Line Cover (5-25 kV)

The Raychem MVLC cover is a cold-applied wrap-around cover that provides retrofit insulation for overhead conductors to help prevent electrical outages caused by incidental contact from tree branches or wildlife. The MVLC cover may be applied selectively on problem spans to avoid costly conductor replacement. Installation is possible on energized lines utilizing the MVLC tool which attaches directly to the overhead conductor and remains stationary in a single location. The tool may be manually or automatically operated, using a gasoline powered drill. The tool forms, closes, and feeds the MVLC cover along the conductor with speed and consistency. The MVLC hand tool allows for quick installation on short lengths of conductors, especially in substations.

### Selection Information: dimensions in inches (millimeters)

Product Size	Conductor Size	Max. Conductor Dia.	Voltage Class
<b>Covers for overhead conductors</b>			
MVLC-14-A/U-C-100	#6-3/0kcmil	0.5 (12.7)	15 kV
MVLC-14-A/241-C-100	#6-3/0kcmil	0.5 (12.7)	25 kV
MVLC-18-A/U-C-75	#2-397kcmil	.75 (18)	15 kV
MVLC-18-A/241-C-75	#2-397kcmil	.75 (18)	25 kV (sealing mastic in receptacle)
MVLC-38-A/U-C-50	477-1590kcmil	1.5 (38)	15 kV
MVLC-38-A/241-C-50	477-1590kcmil	1.5 (38)	25 kV (sealing mastic in receptacle)

### Installation Tools for overhead conductors

MVLC-14-TOOL-100	for use with MVLC-14	15-25 kV
MVLC-18-TOOL-03-2006	for use with MVLC-18	15-25 kV
MVLC-38-TOOL-03-2006	for use with MVLC-38	15-25 kV
MVLC-Hydraul-Drill	non-impact hydraulic drill	

### Covers & Installation Tools for substation use

MVLC-14-1830/U (B18)	package of 18 six foot lengths for 15 kV use
MVLC-14-1830/241 (B18)	package of 18 six foot lengths for 25 kV use
MVLC-18-1830/U (B18)	package of 18 six foot lengths for 15 kV use
MVLC-18-A/241-1830 (B18)	package of 18 six foot lengths for 25 kV use
MVLC-38-A/U-1830 (B18)	package of 18 six foot lengths for 15 kV use
MVLC-38-A/241-1830 (B18)	package of 18 six foot lengths for 25 kV use
MVLC-HAND-TOOL-14	hand tool for installing MVLC-14
MVLC-HAND-TOOL-02	hand tool for installing MVLC-18 and 38

### Ordering/Application Information

- OLIC-C, MVLC-38-SPLICE-COVER, and S-1251 mastic can be used to cover splices.
- Overhead Conductors: standard package for MVLC-14 is 330 feet (100m) continuous on a spool. Standard package for MVLC-18 is 247 feet (75 m) continuous on a spool. Standard package for MVLC-38 is 165 feet (50 m) continuous on a spool.
- Please contact TE Connectivity for use on 35 kV and other sizes.
- Related Test Reports: EDR-5308, EDR-5309, EDR-5316
- MVLC TOOL contains the MVLC installation tool, MVLC cutters, drainage hole punch, hand crank, and a drive nut socket packaged in a protective bag.
- MVLC can be installed at temperatures above 0°C (32°F).

Overhead

Product Performance

Test	MVLC-A/U / MVLC-A/241 (Sealed)
AC withstand (dry)-1 minute	15 kV min. / 25 kV min.
AC withstand (wet)-1 minute	15 kV min. / 25 kV min.
AC long term withstand (dry)-4 hours	8.6 kV min. / 14.4 kV min.
30 day thermal loading (8 hr @ 130°C; 16 hr off)	No MVLC deformation
Conductor ampacity	82-89% of bare conductor ampacity

Material Properties Per pps 3010/42		Test Method	Requirement
Physical	Tensile Strength	ASTM D638	8 MPa min. 1150 psi min.
	Ultimate Elongation	ASTM D638	200% min.
	Abrasion Resistance	1000 cycles, 2068g	20% max. thickness loss
	Low Temperature Impact	ASTM D746	No cracking at -20°C
Electrical	Dielectric Strength	ASTM D149	217 kV/cm @ 1.27 mm 550 V/mil min @ 0.050"
	Tracking and Erosion Resistance	ASTM D2303 Step Voltage Method (Initiate @ 2.5 kV)	No tracking or erosion to top surface or flame failure after: 200 minutes



Installation Tool for Overhead Conductors



MVLC-HAND-TOOL-14



MVLC-HAND-TOOL-02

For Busbar Applications:

2"	use 1-MVLC-38 and 1-MVLC-18
2.5" L	use 2-MVLC-38
3"	use 2-MVLC-38
4"	use 2-MVLC-38 and 1-MVLC-18

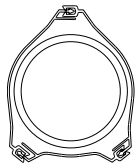

4" busbar with 2-MVLC-38  
1-MVLC-18

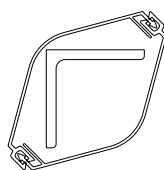

2.5" L busbar with 2-MVLC-38



2 Pieces: MVLC-38 on busbar  
with BCIC

Nominal Dimensions

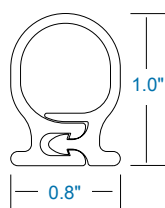

MVLC-14

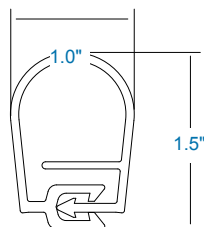

MVLC-18

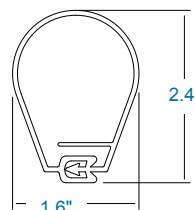

MVLC-38



C\_HVCE

## HVCE High Voltage Creepage Extenders

Raychem heat-shrinkable creepage extenders help to increase the flashover performance of insulators by reducing the surface electrical stress and leakage current and increasing the electric strength of the insulators. The extenders are designed to be resistant to conventional spray washing techniques and will withstand most normal handling, abuse, and extreme weather conditions.

### Selection Information: dimensions in inches (millimeters)

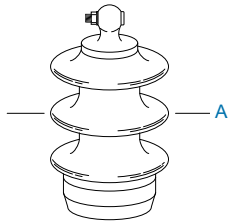

Catalog Number	Skirt Diameter of Insulator (Min.-Max.) A	Nominal Min. Internal Diameter of HVCE*	Creepage Extension Per Extender (in.)	Std. Pack (pcs/box)
HVCE 100/80-01 (B6)	3.20-3.90 (81-99)	4.50 (114)	4	6
HVCE 120/100-01 (B6)	3.90-4.70 (99-119)	5.30 (135)	4	6
HVCE 140/120-01 (B6)	4.70-5.50 (119-140)	6.10 (155)	4	6
HVCE 160/140-01 (B6)	5.50-6.30 (140-160)	7.00 (178)	4	6
HVCE 183/161-01 (B6)	6.30-7.20 (160-183)	8.00 (203)	4	6
HVCE 205/184-01 (B6)	7.20-8.10 (183-206)	9.00 (229)	4	6
HVCE 226/206-11 (B6)	8.10-8.90 (206-226)	9.40 (239)	4	3
HVCE 247/227-11 (B6)	8.90-9.70 (226-246)	10.30 (262)	4	3
HVCE 268/248-11 (B6)	9.70-10.50 (246-267)	11.10 (282)	4	3
HVCE 289/269-11 (B6)	10.50-11.40 (267-290)	11.90 (302)	4	3
HVCE 310/290-11 (B6)	11.40-12.20 (290-310)	12.70 (323)	4	3
HVCE 331/311-11 (B6)	12.20-13.00 (310-330)	13.60 (345)	4	3
HVCE 352/332-11 (B6)	13.00-13.90 (330-353)	14.40 (366)	4	3
HVCE 373/353-11 (B6)	13.90-14.70 (353-373)	15.20 (386)	4	3
HVCE 394/374-11 (B6)	14.70-15.50 (373-393)	16.10 (409)	4	3

\*As supplied

### Ordering/Application Information

1. Select the appropriate catalog number. Confirm selection with insulator skirt outer diameter (A).
2. Each HVCE extender adds a nominal 4 inches to the creepage length. As a general recommendation, TE advises a 20 percent increase in existing creepage distance. Use this formula to calculate the number of creepage extenders needed: Existing creepage distance in inches  $\times 0.2 \div 4 =$  Minimum number of HVCE creepage extenders recommended (i.e., 40 inches creepage  $\times 0.2 \div 4 = 2$  HVCEs needed). Always round up to a whole number (i.e., 1.33 to 2 HVCE's).
3. For applications that do not fall within the ranges above, contact your local TE representative.
4. HVCE does not upgrade the voltage class of the insulator.
5. Related test reports:  
 UVR-8138  
 UVR-8144  
 UVR-8037  
 EDR-5350



C\_HVCE\_WA

## HVCE-WA High Voltage Wraparound Creepage Extenders

Raychem High Voltage Wraparound Creepage Extenders (HVCE-WA) are designed for use in highly contaminated environments. In order to select the appropriate size of HVCE, an insulator or section of an insulator must be obtained. Then measure accurately the dimensions of the shed diameter and outside profile of the shed at its farthest point. This can be done by breaking a piece of porcelain off of the insulator or by using a profile gauge. The vital measurements needed to select a creepage extender are shown below. The illustration (Diagram B) shows an example of a typical cross section of an HVCE with the dimensions representing that of the insulator profile.

### Selection Information: dimensions in inches (millimeters)

Catalog Number	Shed Diameter of Insulator A	Std Pk
HVCE-WA-175-02-FT (B6)	6.90 (175)	6
HVCE-WA-206-01 (B6)	8.11 (206)	6
HVCE-WA-216-01 (B6)	8.50 (216)	6
HVCE-WA-221-01 (B6)	8.70 (221)	6
HVCE-WA-226-01 (B6)	8.90 (226)	6
HVCE-WA-227-01 (B6)	8.94 (227)	6
HVCE-WA-234-01 (B6)	9.21 (234)	6
HVCE-WA-244-01-FT (B6)	9.61 (244)	6
HVCE-WA-248-01 (B6)	9.76 (248)	6
HVCE-WA-251-01 (B6)	9.88 (251)	6
HVCE-WA-255-01 (B6)	10.04 (255)	6
HVCE-WA-267-01 (B6)	10.51 (267)	6
HVCE-WA-271-01 (B6)	10.67 (271)	6
HVCE-WA-280-01 (B6)	11.02 (280)	6
HVCE-WA-281-01 (B6)	11.06 (281)	6
HVCE-WA-287-01 (B6)	11.30 (287)	6
HVCE-WA-292-01 (B6)	11.50 (292)	6
HVCE-WA-303-01 (B6)	11.93 (303)	6
HVCE-WA-323-01 (B6)	12.72 (323)	6
HVCE-WA-326-01 (B6)	12.83 (326)	6
HVCE-WA-330-01 (B6)	13.00 (330)	3
HVCE-WA-336-01 (B6)	13.23 (336)	6
HVCE-WA-341-01 (B6)	13.39 (341)	6
HVCE-WA-348-01 (B6)	13.70 (348)	6
HVCE-WA-349-01 (B6)	13.74 (349)	6
HVCE-WA-356-01 (B6)	14.02 (356)	6
HVCE-WA-359-01 (B6)	14.13 (359)	3
HVCE-WA-364-01 (B6)	14.33 (364)	6
HVCE-WA-367-01 (B6)	14.45 (367)	6
HVCE-WA-372-01 (B6)	14.65 (372)	6
HVCE-WA-373-01 (B6)	14.68 (373)	6
HVCE-WA-377-01 (B6)	14.84 (377)	6
HVCE-WA-381-01 (B6)	15.00 (381)	6
HVCE-WA-392-01 (B6)	14.53 (392)	6
HVCE-WA-393-01 (B6)	15.47 (393)	6
HVCE-WA-406-01 (B6)	15.98 (406)	6
HVCE-WA-407-01 (B6)	15.98 (407)	6
HVCE-WA-413-01 (B6)	16.26 (413)	6
HVCE-WA-421-01 (B6)	16.54 (421)	6
HVCE-WA-426-01 (B6)	16.77 (426)	6
HVCE-WA-429-01 (B6)	16.89 (429)	6
HVCE-WA-440-01 (B6)	17.32 (440)	6
HVCE-WA-442-01 (B6)	17.40 (442)	6
HVCE-WA-452-01 (B6)	17.60 (452)	6
HVCE-WA-457-01 (B6)	18.00 (457)	6
HVCE-WA-463-01 (B6)	18.23 (463)	6
HVCE-WA-482-01 (B6)	16.98 (482)	3
HVCE-WA-488-01 (B6)	19.21 (488)	6
HVCE-WA-490-01 (B6)	19.29 (490)	6
HVCE-WA-501-01 (B6)	19.72 (501)	6
HVCE-WA-528-01 (B6)	20.79 (528)	3
HVCE-WA-551-01 (B6)	21.69 (551)	3
HVCE-WA-584-01 (B6)	22.99 (584)	3
HVCE-WA-611-01 (B6)	24.05 (611)	6

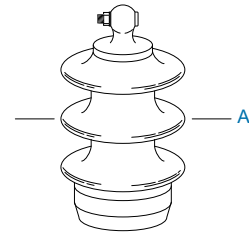
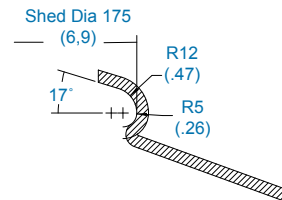

Diagram B



### Ordering/Application Information

1. Each HVCE-WA Extender adds nominal 6 inches to the creepage length. As a general recommendation, TE advises a 20 percent increase in existing creepage distance. Use this formula to calculate the number of creepage extenders needed: Existing creepage distance in inches x 0.2 ÷ 6 = Minimum number of HVCE creepage extenders recommended. (i.e., 60" x .2 ÷ 6 = 2 HVCE-WAs needed). Always round up to a whole number (i.e., 1.33 = 2 HVCE's needed).
2. For applications that do not fall within the ranges above, contact your TE representative.
3. HVCE does not upgrade the voltage class of the insulator.
4. Related test reports: UVR-8152, EDR-5350  
Related Installation Instructions: HVCE-WA
5. Installation Tool: HVCE-WA-TOOL



C\_HVBS

## HVBS High Voltage Booster Shed

The Raychem Booster Shed is a loose fitting collar made from Raysulate anti-tracking polymer which is spaced from the porcelain skirt by short pegs and from the insulator core by spacers. Booster sheds prevent “heavy wetting” flashover by breaking up the water cascades from skirt to skirt. Booster sheds have also been proven to prevent ice-cascade-induced flashovers.

### Feature and Benefits

- Wraparound installation speeds installation time since the connections don’t need to be disconnected
- Superior UV resistance
- Anti-tracking material

### Applications

- Circuit breaker bushings
- Bus support insulators
- Surge arresters
- Transformer bushings

### Selection Information: dimensions in inches (millimeters)

Catalog Number	Suitable Insulator Core	Medium Outside Insulator Skirt	Booster Shed Diameter Fully Installed
HVBS-770/310-01-M-BP	8.9-10.1 (227-257)	12.0 (304)	28.1 (713)
HVBS-740/280-01-M-BP	7.8-9.0 (199-229)	10.9 (276)	27.0 (685)
HVBS-710/250-01-M-BP	6.9-7.9 (175-201)	9.8 (249)	25.9 (657)
HVBS-685/225-01-M-BP	6.2-7.0 (158 -178)	9.3 (235)	25.0 (634)
HVBS-665/205-01-M-BP	5.5-6.3 (140-160)	8.5 (216)	24.3 (616)
HVBS-615/155-01-M-BP	3.7-4.5 (94-114)	6.3 (161)	22.4 (569)

### Product Information

Related Test Report: UVR-8107 Qualification report for Booster Sheds



C\_RRGS

## Raychem RRGS Polymeric and Porcelain Rigid Red Guano Shield

The rigid red guano shield protects against bird streamer caused outages. There are designs to fit both porcelain bells and polymeric insulators. This two piece shield attaches easily with plastic bolts and nuts around the top of the insulator and provides protection from fecal contaminates coming from above the insulator string. For porcelain applications there are 18 inch and 24 inch diameter shield designs. For polymeric applications the shield has an 18 inch diameter.

### Selection Information: dimensions in inches

Catalog Number	Insulator Type	Shield Diameter
RRGS-35/470-FT (B12)	Polymeric	18
RRGS-35/600-FT (B12)	Polymeric	24
RRGS-35/470-M (B12)	Porcelain	18
RRGS-35/600-M(B12)	Porcelain	24

*Also available in gray.*



Polymeric RRGS Shield



Porcelain RRGS Shield



## ACCESSORIES & TOOLS

### Splicing Accessories

HV-BRAID Ground Braid .....	262
HVS-MESH Shielding Mesh .....	262
JGK-MS Jacketed Cable Ground Kits (5-35 kV) .....	262
Cable Preparation Kit .....	263
HVS-GC Grounding Clamps .....	263
HVS-LR Lead Sheath Repair Kits .....	264

### Termination Accessories

BRKT-SS Cable Mounting Brackets .....	265
EAKT-1520 Mounting Kits .....	265

### Conduit/Cable Sealing

RDSS Sealing System .....	267
Blank Duct Plug .....	268

### Torches & Heat Guns

Torches .....	269
Torch Accessories .....	270
Torch Kits .....	270
Heat Guns .....	271

### Tools

Splicing Tools .....	272
Impact Wrench .....	272
Wire Cutters .....	272
Cable Cutters .....	273
Cable Vise .....	273
Stripping Tools .....	274
Tool Sets .....	274

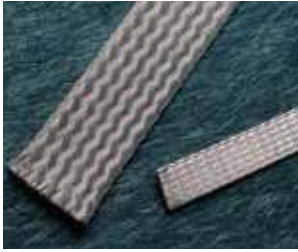

C\_HV\_Braid

## HV-BRAID Ground Braid

Raychem HV-Braid is tinned copper braid, solder-blocked for use with HVS and HVT kits.

### Selection Information: dimensions in inches (millimeters)

Catalog Number	Braid Size (AWG)	Length of Moisture-Blocked Braid	Std. Pack (pcs/box)
HV-BRAID-8-1520	#8	60 (1524)	3
HV-BRAID-6-1520	#6	60 (1524)	3
HV-BRAID-4-1520	#4	60 (1524)	3

### Ordering Information

Order shielding mesh based on braid size.



C\_HVS\_Mesh

## HVS-MESH Shielding Mesh

Raychem HVS-MESH is used in conjunction with high-voltage ground braids to provide shield continuity when splicing shielded power cables.

### Selection Information: dimensions inches/feet (millimeters/meters)

Catalog Number	Width	Length	Std. Pack (Rolls/Box)
HVS-MESH-2-5000	2 (51)	16 (4.8)	4

### Ordering Information

1. Order shielding mesh based on cable diameter and length of cable to be covered.
2. To apply shielding mesh, half-lap around cable.



C\_JGK\_MS

## JGK-MS

The Raychem JGK-MS kit addresses the RUS recommendation to externally ground the jacketed cable neutrals at least four times per mile to limit shield standing voltage, to avoid accidental shock, and to provide multiple parallel return paths for line-to-ground faults.

- Heat-shrinkable JGK-MS kits provide complete environmental sealing with a wraparound, adhesive-lined re-jacketing sleeve.
- Each kit contains a constant-force ground clamp, a solder-blocked ground braid for external grounding, and a sealant to encapsulate and seal the ground connector.
- Kits are RUS accepted and have been tested to meet the 10 kA/10 cycles or 15 kA/15 cycle fault current test requirements.
- Wraparound re-jacketing sleeve has been water-seal tested to the applicable sections of ANSI C 119.1.

### Selection Information: dimensions in inches (millimeters)

Catalog Number	Nominal Use Range (AWG/kcmil)			Fault Current
	15 kV	25 kV	35 kV	
JGK-MS-1	#4-4/0	#1-1/0		10 kA, 10 cycles
JGK-MS-2	250-1000	1/0-750	1/0-500	15 kA, 15 cycles
JGK-MS-3	1000-2000	750-1750	500-1500	15 kA, 15 cycles

### Ordering Information

1. Standard package: 3 kits/box
2. Related test report: EDR-5242





C\_P63

## Cable Preparation Kit

### P63

- Raychem P63 cable preparation kits can be used with all TE Connectivity cable accessories
- Use P63 kits to clean and abrade cable insulation

#### Selection Information

Catalog Number	Std. Pack (kits/box)
P63	12

#### Ordering Information

1. One kit contains six solvent wipes, six dry wipes and three strips of abrasive paper.
2. For splices, the number of prep kits vary depending upon size of cable and type of splice. For terminations, one prep kit will clean three phases (one 3/C termination or three 1/C terminations).
3. Solvent wipes contain PT Technologies type PF cleaner.



C\_HVS\_SG

## HVS-GC Grounding Clamps

Raychem HVS-GC are used for securing ground brades when splicing or terminating power cables.

#### Selection Information: dimensions in inches (millimeters)

Catalog Number	Use Range	Std. Pack (Pcs./Box)
HVS-GC-0.5	0.5-1.0 (13-25)	100
HVS-GC-1.0	1.0-2.0 (25-51)	100
HVS-GC-1.5	1.5-3.0 (38-76)	50
EPPA-034-A	0.5-0.8 (12-20)	
EPPA-034-E	0.7-1.1 (17-29)	
EPPA-034-F	1.2-1.5 (30-39)	
EPPA-034-G	1.6-2.4 (40-60)	
EPPA-034-H	2.0-3.0 (50-75)	
EPPA-034-L	2.3-3.3 (57-85)	

#### Ordering Information

1. Order ground clamps based on cable diameter.
2. Confirm size with use range.



C\_HVS\_LR

## HVS-LR

The Raychem HVS-LR series kit offers a simple method of repairing lead sheath damage on paper-insulated, lead-covered (PILC) cables.

- Combines the strength and durability of TE Connectivity's Raychem MBSM wraparound sleeve with an effective oil-resistant sealing mastic.
- Tested to and meet the following load-cycling and pressure test requirements indicated in the chart below

### Product Performance

Test	Result
Current cycling at 110°C conductor temperature for 90 cycles (5 hours on, 3 hours off)	Pass
Applied pressure	15 psi
Maximum continuous conductor temperature	110°C

### Selection Information: dimensions in inches (millimeters)

Catalog Number	Nominal Sleeve Length	Application use Range (Min.-Max.)
HVS-LR-75/15-600	24 (600)	0.65-2.65 (17-67)
HVS-LR-75/15-1200	48 (1200)	0.65-2.65 (17-67)
HVS-LR-160/42-600	24 (600)	1.80-5.70 (46-144)
HVS-LR-160/42-1200	48 (1200)	1.80-5.70 (46-144)
HVS-LR-200/50-600	24 (600)	2.15-7.10 (55-180)
HVS-LR-200/50-1200	48 (1200)	2.15-7.10 (55-180)

### Ordering Information

1. Be sure to look at both the cable jacket diameter and the lead sheath diameter when selecting the HVS-LR kit.
2. Standard package: 3 kits/box
3. Related test report: EDR-5243



C\_BRKT\_SS

## BRKT-SS Cable Mounting Brackets

Raychem BRKT-SS cable mounting brackets are versatile and may be used outdoors. The brackets are constructed of stainless steel and include all hardware.

- Suitable for use on all types of cables
- For use with terminations or other applications where cable mounts are needed
- Includes a mounting bracket and rubber pad

### Selection Information: dimensions in inches (millimeters)

Catalog Number	Cable Range O.D. Range
BRKT-1-SS	0.80-1.25 (20-32)
BRKT-2-SS	1.10-1.50 (28-38)
BRKT-3-SS	1.45-1.95 (37-50)
BRKT-4-SS	1.80-2.40 (46-61)

### Ordering Information

1. Standard package: 1 bracket/box
2. Order brackets based on cable diameter, confirm size with use range.
3. Related test report: NCTR-99-065

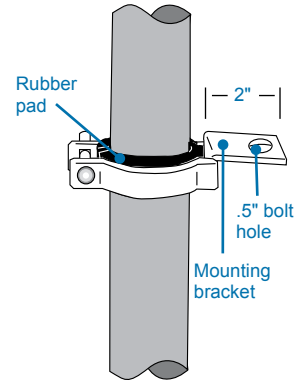

C\_EAKT-1520

## EAKT-1520 Mounting Kits

TE Connectivity Raychem offers a mounting bracket and support insulators for poletop mounting of TE high voltage terminations. The EAKT-1520 series mounting kits provide a galvanized steel bracket, three insulators for mounting outdoor terminations, and installation instructions.

The bracket is dip galvanized to meet outdoor requirements (BS 729). The insulators are lightweight and shatterproof. They combine a strong and flexible polymeric core with TE's proven high-voltage, nontracking material.

- Used with TE's Raychem high-voltage outdoor termination kits (15–35 kV).
- Includes a galvanized steel T-bracket, three insulators for poletop mounting, and installation instructions.

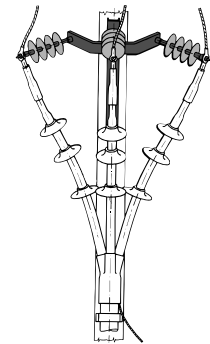
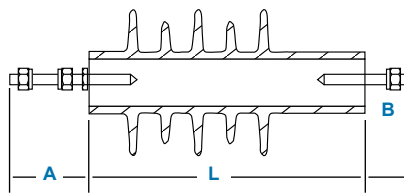
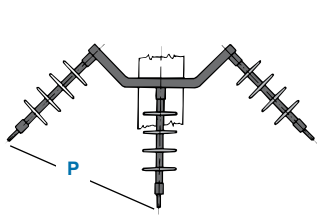

### Selection Information: dimensions in inches (millimeters)

Catalog Number	Voltage Class (kV)	Insulator Dimensions				No. of Skirts	Min. Creepage Length	Mechanical Capabilities Cantilever	Torque M12 (ft. lb)
		P	L	A	B				
EAKT 1521	15	12.5 (310)	7.6 (195)	2.6 (65)	1.4 (35)	5	15.4 (390)	184	37
EAKT 1523	25	17.0 (430)	12.0 (305)	2.6 (65)	1.4 (35)	9	26.0 (660)	184	37
EAKT 1524	35	22.0 (560)	15.0 (380)	2.6 (65)	1.4 (35)	11	43.3 (1100)	516	37

### Ordering Information

1. Standard package: 1 kit/box.
2. Related test reports: UVR-8150, UVR-8166





C\_RDSS

## RDSS Sealing System Duct Sealing System

TE'S Raychem RDSS duct sealing system has been designed for use in conjunction with plastic, concrete, or steel ducts to provide a watertight duct seal. The RDSS duct sealing system seals cable ducts and helps to prevent flooding in cable vaults, access manholes, substation basements, and customer feeds. It can be installed while the water is flowing—see photograph.

### Provides Watertight Seal

The RDSS sealing system consists of an inflatable, sealed bladder of flexible, metallic laminate material, which has pre-installed, high-temperature sealant strips on both sides. The bladder is first inflated to 45 psi (three-bar) internal pressure, and then presses the sealant against the duct wall and onto the substrate. The bag uses a self-sealing gel material to seal the filling hole when the filling tube is removed.

### Seals Multiple Cable Ducts

For applications with three or more cables, an RDSS-CLIP is inserted between the cables. The RDSS-CLIP is a high-temperature mastic mounted on an installation stick. It seals the area between the cables when used in conjunction with the RDSS inflatable bladder. Acceptable to use on medium voltage cables including unjacketed concentric neutral.

### Selection Information: dimensions in inches (millimeters)

Duct Inner Diameter	Number of Cables in Duct / Maximum Cable Bundle Diameter					
	0, 1, or 2 Cables		3 or 4 Cables		5, 6, or 7 Cables	
1.25 (32)	RDSS-45	0.5 (13)	RDSS-45, 1 RDSS-CLIP-45	0.3 (8)	RDSS-45, 2 RDSS-CLIP-45	0.1 (3)
1.50 (38)	RDSS-45	1.0 (25)	RDSS-45, 1 RDSS-CLIP-45	0.8 (20)	RDSS-45, 2 RDSS-CLIP-45	0.6 (15)
1.75 (45)	RDSS-45	1.3 (32)	RDSS-45, 1 RDSS-CLIP-45	1.05 (27)	RDSS-45, 2 RDSS-CLIP-45	0.9 (22)
2.00 (50)	RDSS-60	1.2 (30)	RDSS-60, 1 RDSS-CLIP-75	1.0 (25)	RDSS-60, 2 RDSS-CLIP-75	0.8 (20)
2.25 (57)	RDSS-60	1.6 (41)	RDSS-75, 1 RDSS-CLIP-75	1.4 (36)	RDSS-75, 2 RDSS-CLIP-75	1.2 (31)
2.50 (64)	RDSS-75	1.5 (38)	RDSS-75, 1 RDSS-CLIP-75	1.3 (33)	RDSS-75, 2 RDSS-CLIP-75	1.1 (28)
2.75 (70)	RDSS-75	1.8 (46)	RDSS-75, 1 RDSS-CLIP-75	1.6 (41)	RDSS-75, 2 RDSS-CLIP-75	1.4 (36)
3.00 (75)	RDSS-75	2.2 (56)	RDSS-75, 1 RDSS-CLIP-75	2.0 (50)	RDSS-75, 2 RDSS-CLIP-75	1.8 (46)
3.25 (83)	RDSS-100	2.2 (56)	RDSS-100, 1 RDSS-CLIP-100	2.0 (50)	RDSS-100, 2 RDSS-CLIP-100	1.8 (46)
3.50 (89)	RDSS-100	2.6 (66)	RDSS-100, 1 RDSS-CLIP-100	2.4 (61)	RDSS-100, 2 RDSS-CLIP-100	2.2 (56)
3.75 (95)	RDSS-100	2.9 (74)	RDSS-100, 1 RDSS-CLIP-100	2.7 (69)	RDSS-100, 2 RDSS-CLIP-100	2.5 (64)
4.00 (100)	RDSS-100	3.2 (80)	RDSS-100, 1 RDSS-CLIP-100	3.0 (75)	RDSS-100, 2 RDSS-CLIP-100	2.8 (70)
4.25 (108)	RDSS-100	3.5 (89)	RDSS-100, 1 RDSS-CLIP-100	3.3 (85)	RDSS-100, 2 RDSS-CLIP-100	3.1 (79)
4.50 (114)	RDSS-100	3.5 (89)	RDSS-100, 1 RDSS-CLIP-100	3.3 (85)	RDSS-100, 2 RDSS-CLIP-100	3.1 (79)
4.75 (121)	RDSS-125	3.8 (97)	RDSS-125, 1 RDSS-CLIP-125	3.6 (92)	RDSS-125, 2 RDSS-CLIP-125	3.4 (87)
5.00 (125)	RDSS-125	4.1 (104)	RDSS-125, 1 RDSS-CLIP-125	3.9 (98)	RDSS-125, 2 RDSS-CLIP-125	3.7 (93)
5.25 (133)	RDSS-150†	4.3 (109)	RDSS-150†, 1 RDSS-CLIP-150	4.1 (104)	RDSS-150†, 2 RDSS-CLIP-150	3.9 (98)
5.50 (140)	RDSS-150†	4.7 (120)	RDSS-150†, 1 RDSS-CLIP-150	4.5 (114)	RDSS-150†, 2 RDSS-CLIP-150	4.3 (109)
5.75 (146)	RDSS-150†	4.9 (124)	RDSS-150†, 1 RDSS-CLIP-150	4.7 (119)	RDSS-150†, 2 RDSS-CLIP-150	4.5 (114)
6.00 (150)	RDSS-150†	5.1 (129)	RDSS-150†, 1 RDSS-CLIP-150	4.9 (124)	RDSS-150†, 2 RDSS-CLIP-150	4.7 (120)
6.25 (159)	RDSS-150†	5.4 (138)	RDSS-150†, 1 RDSS-CLIP-150	5.2 (133)	RDSS-150†, 2 RDSS-CLIP-150	5.0 (125)

6.50-8.00 (165-210) Ducts in this range require the use of RDSS-AD-210 adapter. Contact your TE representative for application information.

†See Ordering information.

### Ordering Information

- In ducts where the cable/cable bundle is less than 2.4" (60mm) in diameter, an RDSS-AT/AP-150 device must be used in conjunction with the RDSS-150.
- Standard package: RDSS = 10 kits/box or 3 kits/box  
RDSS-CLIP = 5 clips/box  
RDSS-TOOLS = 1 each/box, CO2 cartridges = 10 each/box, RDSS-AT/AP-150 = 1 each/box
- Related test report: EDR-5253
- S-1278 sealant, used in RDSS-CLIPS, is available separately.
- For proper inflation do not exceed the maximum cable bundle diameter (MCBD). To determine MCBD, use a diameter tape or contact your TE representative for assistance.

### RDSS Sealing Clip

RDSS duct sealing clips are to be used if the duct is occupied by more than two cables. The maximum number of cables sealed with one RDSS-CLIP is four. If more cables are to be sealed, one extra clip is needed for every three additional cables. Check with your TE representative for applications with more than seven cables.

Catalog Number	Kit Used With
RDSS-CLIP-45	RDSS-45
RDSS-CLIP-75	RDSS-75 and RDSS-60
RDSS-CLIP-100	RDSS-100
RDSS-CLIP-125	RDSS-125
RDSS-CLIP-150	RDSS-150

**RDSS Installation Tools**

RDSS duct seals can be installed with a variety of inflation tools having the capability of inflating RDSS to 45±3 psi (3 bar) of pressure. The tools TE Connectivity offers are summarized in the table below. The tool will only accept 16-gr CO2 gas cylinders (listed below).

**RDSS-IT-16**



**RDSS-IG-SR-AS**

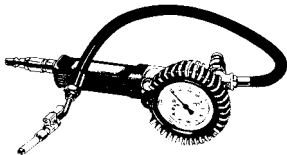

Catalog Number	Description	Std. Pack
RDSS-IT-16	Inflation tool designed with an ON/OFF switch and an automatic pressure-monitoring system. The required CO2 gas cylinders (E7512-0160) must be ordered separately.	1 tool/box
E7512-0160	16-gr CO2 gas cylinders for the RDSS-IT-16 tool. Each gas cylinder inflates approximately four RDSS-100 duct seals.	10 cylinders/box
RDSS-IG-SR-AS	Inflation tool designed for use with customer's own source of nitrogen or compressed air. Features a pressure gauge, automatic shutoff, VGF valve connection, and two alternate connections for plastic or rubber hoses.	1 tool/box
E7512-0220	Tube snap assembly. Spare part for RDSS-IT-16 inflation tool.	1 each/box
E7512-0240	Spare pressure gauge assembly for RDSS-IT-16 inflation tool.	1 each/box
E7512-0260	Spare delivery pipe for RDSS-IT-16 inflation tool.	1 each box
S-1278-3 x 61 x 7620	RDSS sealant roll.	1 25-ft roll/box
RDSS-AT/AP-150	For use with the RDSS-150 in duct 5.25" or larger with cable/cable bundles less than 2.4" (60 mm) in diameter.	1 each/box
RDSS-AD-210	Adapter for ducts 6.5 - 8.0" (165 - 210 mm) diameter	4 each/box
E4540-1250	RDSS-LUBE for installation of RDSS.	25 each/box



C\_BlankDuct

**Blank Duct Plug**  
Duct Plug | Sealing Ducts

TE's Raychem Blank Duct Plugs effectively seal empty conduits to reduce the cost of cable placement and maintenance in new underground construction projects and routine work. Plugs are removable and reusable providing a more economical sealing solution. These plugs prevent the flow of water and the costly sedimentation of duct banks and conduit systems while confining problems of dangerous vapors to their source.

Manufactured from high-impact plastic components, combined with durable elastic gaskets, blank plugs are corrosion proof and effective for long-term or temporary sealing.

Each blank plug is equipped with a rope tie mechanism that provides the benefit of securing a pull rope to plug's back compression plate and the allowance of storing excess slack rope behind the plug within the conduit system for future use.

- All plastic construction
- Corrosion proof
- Water and gas tight
- Easy Installation and removal
- Fully removable and reusable

**Selection Information: dimensions in inches (millimeters)**

Catalog Number	Plug Diameter	Duct ID	STD Pack
RBDP-BLA-10D104U	1.00	0.96-1.16 (24.4-29.5)	12
RBDP-BLA-12D148U	1.25	1.14-1.48 (29.0-37.6)	12
RBDP-BLA-15D183U	1.50	1.49-1.83 (37.8-46.5)	12
RBDP-BLA-20D236U	2.00	1.83-2.36 (46.5-59.9)	12
RBDP-BLA-30D346U	3.00	2.99-3.46 (75.9-87.9)	12
RBDP-BLA-40D402U	4.00	3.94-4.17 (100.0-105.9)	8
RBDP-BLA-50D535U	5.00	5.00-5.35 (127.0-135.9)	8
RBDP-BLA-60D637U	6.00	5.82-6.37 (147.8-161.8)	8
RBDP-BLA-80D816U	8.00	7.83-8.27 (198.9-210.1)	8

## Torches

*These clean-burning, efficient, heat-shrinking torches are recommended for shrinking high voltage products through low voltage products*

### Selection information

---

#### Primus-Sievert Siever-Matic Torch Materials



C\_Torches

#### FH-3366-97-PS-HANDLE

- Siever-Matic S auto ignite, auto shut-off torch handle
- Ergonomic design ensures comfortable operation
- Adjustable output
- Piezo ignition



#### FH-AD-3061-23-PS-REGULATOR

- Works with torch handle FH-3366-97-PS-HANDLE above
- Adjustable from 14-57psi
- Fitting POL, UNF 9/16 inch LH
- Requires torch hose AD-1432 or AD-1434



#### FH-AD-3347-91-PS-BURN-1

- Works with torch handle FH-3366-97-PS-HANDLE above
- Recommended especially for low voltage and general purpose products
- Tip diameter 1.0 inch 20,000BTU/hour



#### FH-AD-3341-91-PS-BURN1.5

- Works with torch handle FH-3366-97-PS-HANDLE above
- Recommended especially for low voltage products and high voltage terminations and splices
- Tip diameter 1.5 inch 40,000BTU/hour



#### FH-AD-3348-91-PS-BURN-2

- Works with torch handle FH-3366-97-PS-HANDLE above
- Recommended especially for Raysulate products
- Tip diameter 2.0 inch 90,000BTU/hour

#### Bullfinch Torch Materials



#### FH-2629-TORCH ASSY

- Built-in ignitor recommended for all products
- General purpose, heavy-duty propane torch with comfortable grip
- Provides a clean burning flame for shrinking high voltage products or thick-wall low voltage products.
- Output: Approximately 30,000 BTU/Hour

#### FH-2629-ELECTRODE

- Replacement ignitor for FH-2629 torch

C\_Torch\_Accessories

**AD-1358-LPG-REGW/GAGE**

- Propane tank regulator with gauge (0–30 psi)
- Can also be used with Primus-Sievert or BullFinch products

**AD-1432-ACD10FT-LPG-HOSE**

- 10-foot LPG hose

**AD-1434-ACD30FT-LPG-HOSE**

- 30-foot LPG hose

**AD-1460-ACD-HEAT-SHLDGPA**

- 12 x 40 pad woven of heat-resistant fabric with corner grommets
- Protects adjacent components from torch heat during installation of heat-shrinkable products in confined areas

**AD-1563-ADAPTER**

- Valve to standard hose
- For use with FH-2618A-1 propane torch if disposable cylinders are not used

**AD-3015-04**

- Adapts Siever-Matic S FH-2649-PS-KIT or FH2629 for use with disposable 14.1 oz propane cylinders
- Includes 4-foot hose and regulator preset at 28 psi

C\_Torch\_Kits

**FH-2618A-1**

- Light, portable propane torch for installing low voltage products and smaller, conductor-sized, high-voltage (up to 15 kV) accessories
- Includes hose, handle assembly, and regulator for disposable propane cylinder
- Operates from disposable 14.1 oz. propane cylinders
- Output: Approximately 20,000 BTU/hour
- Handle and torch head not available separately
- Regulator and hose assembly is product AD-3015-04

**FH-2629-Kit**

- Includes (AD-1432) 10 foot hose, (AD-1358) adjustable regulator, and (FH-2629-TORCH-ASSY) torch handle and tip

**FH-2640-PS-KIT**

- Primus-Sievert torch kit for use with disposable propane bottles
- Includes (FH-3366-97-PS-HANDLE, FH-AD-3341-91-PS-BURN1.5, & AD-3015-04)

**FH-2649-PS-KIT**

- Seiver-Matic S auto ignite, auto shut-off torch system
- Recommended especially for Raysulate products and can be used with all products
- Includes ergonomic handle, 30 foot hose, adjustable regulator, and large burner (3348-91); all in a canvas carrying bag
- Output: Approximately 90,000 BTU/hour
- Smaller burner and adapter for disposable bottles available. Includes: FH-3366-97-PS-HANDLE, FH-AD-3348-91-PS-BURN-2, FH-AD-3061-13-PS-REGULAT, AD-1434-ACD30FT-LPG-HOSE, and a carrying bag





C\_Heat\_Guns



CUS Listed  
Heat Gun 16C6

## Heat Guns

These hot-air heat guns are ideal for shrinking small low voltage products and identification marking sleeves. Heat guns are not recommended for shrinking high voltage products or thick-wall low voltage products.

### FH-PS-2001

Primus-Sievert model with increased air flow allows faster shrinking. 120V, 1750 watt, 80°F – 1100°F, Variable air flow: 21 cfm max., double insulated LED read out. This heat gun can be used for shrinking thick-wall low voltage products.

### HG-501A

115 Volts

462047

500°F – 750°F hot-air gun ideal for shrinking ShrinkMark or TMS marking products, and thin-wall tubing. Includes stand. Reflector must be ordered separately.

### HG-751A-C

120 Volts

926935

750°F – 1000°F hot-air gun for shrinking low voltage and marking products. Includes stand. Reflector must be ordered separately.

### Heat Gun Accessories

Catalog Number	Description
TG-12 Reflector	Use on tubing up to 3/4 inch in diameter.
TG-13 Reflector	Use on tubing up to 2 inches in diameter.
TG-23 Reflector	Use on tubing and cable breakouts up to 1 3/4 inches in diameter.
TG-24 Reflector	Use on tubing and cable breakouts up to 3 1/4 inches in diameter.

### Ordering Information

Standard package: 1 each/box.



C\_Glow\_Torch

## Glow Torch

- Lightweight, portable, and ergonomic design
- Provides a wide-flame torch output for instant controlled heating
- Automatic Piezo Electronics Ignition System
- Attaches directly to 1 lb or 2 lb disposable propane bottles
- Installs thin wall, dual wall and adhesive lined heat-shrink tubing and sleeves

### Selection Information:

Catalog Number	Description	Std. Pack
CPGI-GLOW-TORCH	Wide-Flame Torch	10

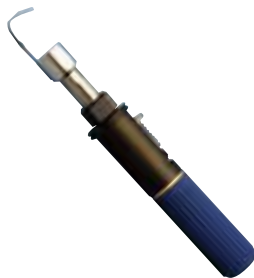

C\_Glow\_Gun

## Glow Gun

- Lightweight, portable, and ergonomic design
- Provides a wide-flame torch output for instant controlled heating
- Automatic Piezo Electronics Ignition System
- Attaches directly to 1 lb or 2 lb disposable propane bottles
- Installs thin wall, dual wall and adhesive lined heat-shrink tubing and sleeves

### Selection Information:

Catalog Number	Description	Std. Pack
CPGI-GLOW-GUN	Flameless heat gun	10



## Splicing Tools

### EXRM-1004-US - Insulation Removal Tool

- Description – hand tool for making ring cuts on cable jackets and EPR insulation.
- Length = 7.5 inches
- Ring cut range - .50-2.00 inches



C\_Splicing\_Tools

### EXRM-0607 - Cable Splice Knife

- Special purpose short blade
- Comfortable full-size handle
- Finest cuttery steel, tough and carefully tempered to hold its edge



## Impact Wrench

### IT-1000-033-US - Cordless Impact Wrench

- Easy and quick installation of mechanical ShearBolt connectors
- Powerful design, class leading torque - 1,460 in-lbs
- Includes battery charger two 12 volt NI-MHt batteries carrying case, sockets 1/2" hexagonal socket sizes 10, 13, 17, 19, 22, 27, 1/4" hexagonal adapter

### CA7478-000 - Battery for Cordless Impact Wrench

### CA7476-000 - Charger for Battery



## Wire Cutters

### 605744-1 - 350 MCM Cutter

- Suitable for copper and aluminum up to 350 MCM
- Steel handles
- Not for steel or ACSR cable



C\_WireCutters

### 605742-1 - 500 MCM Cutter

- Suitable for copper and aluminum up to 500 MCM
- 21 inches overall length
- Fiberglass handles
- Not for steel or ACSR cable



## Cable Cutters

### 1490489-1

- Suitable for copper or aluminum, solid or stranded to 350 MCM
- Ratchet mechanism keeps handle force low
- Handles lock together for safety/storage
- Compact design for easy fit into tight places
- Quick-release lever for easy take-up
- Ideal for cutting cable up to 2/0
- Also cuts coax cable up to RG-9



### 607453-2 1

- Great for copper and aluminum cable up to 1.5" diameter
- Light weight tubular steel handles with vinyl hand grips
- Fixed and moving blade made from high grade alloy steel
- Fast advance button to minimize required motion
- Combines light weight and ratcheted mechanical advantage in its circular cutting motion
- Weight 3.27 Lb [1.49 Kg]
- Not for steel or ACSR cable



### 169415-1

- Solid and stranded copper and aluminium cables
- Solid Cu 185 mm<sup>2</sup>
- Solid Al 240 mm<sup>2</sup>
- Stranded Cu / Al Ø25
- Hi Flex Cu Ø32

C\_CableCutters

### 734045-1

- Solid and stranded copper and aluminium cables
- Solid Cu 185 mm<sup>2</sup>
- Solid Al 185 mm<sup>2</sup>
- Stranded Cu / Al Ø52
- Hi Flex Cu Ø52

### 1-1579002-8

- Solid and stranded copper and aluminium cables (no ASCR)
- Solid Cu 480 mm<sup>2</sup>
- Solid Al 480 mm<sup>2</sup>
- Stranded Cu / Al Ø54



### KMS-K-INT

- Cable Sheath cutter



## Cable Vise

### IT 1000-002

The IT-1000-002 cable vise is for fast and easy installation of joints and the repair of cables. An adaptor is included which enables the cable vise to be used for the installation of terminations. Suitable for field installation and for workshop use. When fixed to a work bench, the upper part with the clamps can be used without the legs. Cable vise for the installation of joints and the repair of cables.

### Cable Vise Adaptor and Clamp (comes with Cable Vise)

Adaptor and clamp for the installation of terminations



C\_CableVise



## Tool Sets

### IT-1000-006 - Assortment of Tools

- 1x Pipe Wrench, size 9.84" (250 mm)
- 1x Side cutter, size 6.30" (160 mm)
- 1x Pincers, size 7.08" (180 mm)
- 1x Combination Pliers, size 7.08" (180 mm)
- 1x Scissors, size 7.87" (200 mm)



### IT-1000-019 - Installation tool for mechanical connectors

This tool avoids the cable cores being over bend during installation of mechanical connectors  
Application diameter range: .59"-2.36" (15-60 mm). Length of handle: 8.07" (205 mm)



### 734587-1 - Cable Tie Gun

- For cable ties 3.3-4.8 mm
- Thickness up to 1.6 mm
- Automatic cut-off
- Adjustable tension setting

C\_ToolSets



## Stripping Tools

### IT-1000-030-2 - Screen Removal Tool

- Screen Removal Tool IT-1000-030-2 for bonded screens on round conductors of MV Cables includes: 1 spare blade, silicone grease and allen key delivered in a robust polypropylene box.
- Suitable for one and three core cables.
- Application range over insulation .39"-1.97" (10-50 mm), Min screen cutback .39" (10mm), variable cutting thickness

### IT-1000-030-2-BLADE - SIML 0-711744-1

- Cable Jacket/lead removal tool



### SIMIL 0711744-1

Cable jacket / lead removal tool PG2, cable diameter .83"-1.37" (21-33 mm)

### SIML 0-711745-1

Cable Jacket / lead removal tool-PG3 Cable Diameter 1.02"-2.04" (26-52 mm)

### SIML 0-711746-1

Cable Jacket / lead removal tool-PG3 Cable Diameter 1.85"-2.95" (47-75 mm)



### SIML 0-0711748-1

Strip insulation of MV cables of diameter between .55"-1.57" (14-40 mm)

### SIML 0-0711749-1

Strip insulation of MV cables of diameter between 1.50"-2.36" (38-60 mm)



### LHM 1R 30/45 - 0-0716541-1

To strip non-bonded semiconductive screen of MV cables of diameter between .55"-1.57" (14-40 mm)

C\_StrippingTools



## APPLICATIONS & TECHNICAL SPECIFICATIONS

Applications by Cable Type .....	276
Low Voltage Tubing and Wraparound Sleeves .....	285
Splices .....	289
Terminations .....	294
Busbar/Wildlife Protection .....	299



	Application(s)	Product(s)	Heat-Shrink	Cold-Applied
	<ul style="list-style-type: none"> <li>Sealed in-line splices</li> <li>Terminal lug seals</li> <li>Insulation</li> <li>Jacket repair</li> </ul>	WCSM FCSM	● ●	
	<ul style="list-style-type: none"> <li>Sealed in-line splices</li> <li>Insulation</li> <li>Jacket repair</li> <li>Terminal lug seals</li> <li>UF underground feeder cable splice</li> </ul>	MWTM RNF-100 Gelwrap closure sleeve GILS closure RVS	● ●	● ●
	<ul style="list-style-type: none"> <li>Submersible secondary BUS connectors</li> </ul>	GelWrap UF closure sleeve GelPort connector		● ●
	<ul style="list-style-type: none"> <li>Sealed motor connections</li> <li>2- or 3-wire stub splices</li> </ul>	MCK MBSM GelCap SL splice cover GWRS	● ●	● ●
	<ul style="list-style-type: none"> <li>Insulation and jacket repair</li> <li>General wraparound sealing</li> </ul>	CRSM MBSM GelWrap splice cover GWRS	● ●	● ●
	<ul style="list-style-type: none"> <li>Wraparound, sealed cable</li> <li>Tap splices</li> </ul>	CRSM-CT GHFC MW GHFC GTAP	●	● ●
	<ul style="list-style-type: none"> <li>End seals for storage and pulling</li> <li>Sealing of live ends (up to 1000V)</li> </ul>	ESC RVC	●	●
	<ul style="list-style-type: none"> <li>Wire and cable marking</li> <li>Labels</li> <li>Hardware and Software</li> </ul>	Identification Solutions		
	<ul style="list-style-type: none"> <li>Installation of heat-shrink products</li> </ul>	Propane torches Heat guns		
	<ul style="list-style-type: none"> <li>Sealing of uncoated tubing</li> </ul>	Sealing mastics		
	<ul style="list-style-type: none"> <li>Duct sealing</li> </ul>	RDSS		
	<ul style="list-style-type: none"> <li>Airport lighting kit</li> </ul>	ALK	●	
	<ul style="list-style-type: none"> <li>Cable breakout boots</li> <li>Network protector sealing</li> </ul>	CBR CBR-NPB	● ●	
	<ul style="list-style-type: none"> <li>Cabinet feed through seals</li> </ul>	CFTS	●	
	<ul style="list-style-type: none"> <li>Cable prep kit</li> </ul>	P-63		●

1/C Nonshielded Power Cable (5 kV)



	Application(s)	Product(s)	Heat-Shrink	Cold-Applied
	<ul style="list-style-type: none"> <li>Indoor terminations (in enclosures)</li> <li>Outdoor (weather-exposed) terminations</li> </ul>	HVT-50	●	
	<ul style="list-style-type: none"> <li>In-line splices</li> </ul>	HVS-500	●	
	<ul style="list-style-type: none"> <li>Sealed motor connections</li> <li>2 wire pigtail splices</li> </ul>	MCK-5 GelCap 8-motor connection	●	●

3/C Nonshielded Power Cables (5 kV)



	Application(s)	Product(s)	Heat-Shrink	Cold-Applied
	<ul style="list-style-type: none"> <li>3/C indoor terminations (in enclosures)</li> <li>3/C outdoor (weather-exposed) terminations</li> </ul>	HVT-50 MOD-3-HVT	● ●	
	<ul style="list-style-type: none"> <li>Cold-applied</li> </ul>	MOD-3-TFT		●
	<ul style="list-style-type: none"> <li>3/C in-line splices—no armor</li> </ul>	HVS-3-500 HVS-3/C mod kits	● ●	
	<ul style="list-style-type: none"> <li>3/C in-line splices—armored</li> </ul>	HVSA-3-500 HVSA mod kits	● ●	
	<ul style="list-style-type: none"> <li>Sealed motor connections</li> <li>2 wire pigtail splices</li> </ul>	MCK-5 GelCap 8-motor connection	●	●

1/C Shielded Power Cable (5-69 kV)

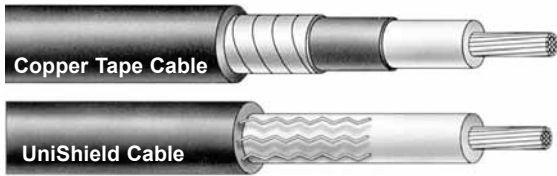

	Application(s)	Product(s)	Heat-Shrink	Cold-Applied		
	<ul style="list-style-type: none"> <li>Indoor heat-shrinkable terminations for copper tape, wire shield, and UniShield cable (in enclosures)</li> </ul>	HVT-80-G (5/8 kV) HVT-150-G (15 kV) HVT-250-G (25 kV) HVT-350-G (35 kV) EHVT-460-G (46 kV) EHVT-690-G (69 kV) GHVT-690-G (69 kV)	● ● ● ● ● ● ●			
	<ul style="list-style-type: none"> <li>Indoor heat-shrink terminations with built in stress control</li> </ul>	HVT-Z-80-G/SG (5/8 kV) HVT-Z-150-G (15 kV) HVT-Z-250/350-G (35 kV)	● ● ●			
	<ul style="list-style-type: none"> <li>Indoor cold-applied terminations (5–15 kV) for copper tape, wire shield and UniShield cable (in enclosures)</li> </ul>	TFT-150R-G (5/8 kV) TFT-E-G (5-15 kV) TFT-P-80R (5/8 kV)		● ● ●		
	<ul style="list-style-type: none"> <li>Indoor heat-shrinkable terminations LC-shield cable (in enclosures) (15–35 kV)</li> </ul>	HVT-150-LC (15 kV) HVT-250-LC (25 kV) HVT-350-LC (35 kV)	● ● ●			
	<ul style="list-style-type: none"> <li>Outdoor heat-shrinkable terminations for copper tape, wire shield, and UniShield cable (weather-exposed)</li> </ul>	HVT-80-G/SG (5/8 kV) HVT-150-SG (15 kV) HVT-250-SG (25 kV) HVT-350-SG (35 kV)	● ● ● ●			
	<ul style="list-style-type: none"> <li>Outdoor heat-shrink terminations with built in stress control, for copper tape, wire shield, and UniShield cable (weather exposed)</li> </ul>	HVT-Z-80-SG (5/8 kV) HVT-Z-150-SG (15 kV) HVT-Z-250/350-SG (25 kV) EHVT-460-SG (46 kV) EHVT-690-SG (69 kV) GHVT-690-SG (69 kV) GHVT-690-SSG	● ● ● ● ● ● ● ●			
	<ul style="list-style-type: none"> <li>Outdoor heat-shrinkable terminations for LC-shield cable (weather exposed) 15–35 kV</li> </ul>	HVT-150-SLC (15 kV) HVT-250-SLC (25 kV) HVT-350-SLC (35 kV)	● ● ●			
	<ul style="list-style-type: none"> <li>Outdoor cold-applied terminations, for copper tape, wire shield, and UniShield cable (weather exposed) (15–35 kV)</li> </ul>	TFT-150R-SG (15 kV) TFT-250R-SG (25 kV) TFT-350R-SG (35 kV) TFT-150E-SG (15 kV) TFT-250E-SG (15 kV) TFT-350E-SG (15 kV) TFT-150E-SLC (15 kV) TFT-250E-SLC (15 kV) TFT-350E-SLC (15 kV)		● ● ● ● ● ● ● ● ●		
		<ul style="list-style-type: none"> <li>In-line splices for copper tape, wire shield, and UniShield cable</li> </ul>	HVS-820S (5/8 kV) HVS-C-1520S (15 kV) HVS-1520S (15 kV) HVS-1550S (15 kV) HVS-2520S (25 kV) HVS-3520S (35 kV) EHVS-6920 (49/69 kV)	● ● ● ● ● ● ●		
		<ul style="list-style-type: none"> <li>In-line splices for LC shield cable (15–35 kV)</li> </ul>	HVS-1530-LC (15 kV) HVS-2530-LC (25 kV) HVS-3530-LC (35 kV)	● ● ●		
		<ul style="list-style-type: none"> <li>In-line splices for copper tape, wire shield, Unishield, flat strap and LC shielded cable (15-35kV)</li> </ul>	CSJA-152X (15 kV) CSJA-282X (25/28 kV) CSJA-352X (35 kV)		● ● ●	
		<ul style="list-style-type: none"> <li>Wye splice</li> <li>H-tap splice</li> </ul>	HVSY-1520S (15 kV only) HVSH-Mod (15 kV only)	● ●		
			<ul style="list-style-type: none"> <li>Sealing of live ends</li> </ul>	HVES-1520D (15 kV) HVES-2520D (25 kV)	● ●	
			<ul style="list-style-type: none"> <li>Sealed motor connections</li> <li>2 wire pigtail splices</li> </ul>	MCK-5 (5/8 kV) GelCap 8 motor connection	●	●



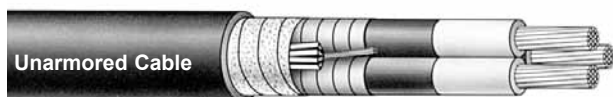

	Application(s)	Product(s)	Heat-Shrink	Cold-Applied
	<ul style="list-style-type: none"> <li>• 3/C indoor terminations (in enclosures)</li> </ul>	HVT-80-G (5/8 kV) HVT-150-G (15 kV) HVT-250-G (25 kV) HVT-350-G (35 kV) HVT-Z-80-G/SG HVT-Z-150-G HVT-Z-250/350-G in conjunction with MOD-3-HVT HVT-80-SG (5/8 kV)	● ● ● ● ● ● ● ●	
	<ul style="list-style-type: none"> <li>• 3/C outdoor terminations (weather-exposed)</li> </ul>	HVT-Z-80-G/SG HVT-150-SG (15 kV) HVT-Z-150-SG HVT-250-SG (25 kV) HVT-350-SG (35 kV) HVT-250/350-SG in conjunction with MOD-3-HVT HVS-3-820S (5/8 kV)	● ● ● ● ● ● ●	
	<ul style="list-style-type: none"> <li>• 3/C in-line splices—no armor</li> </ul>	HVS-3-1520S (15 kV) HVS-3-2520S (25 kV) HVS-3/C (5–35 kV) HVSA-3-820S (5/8 kV)	● ● ● ●	
	<ul style="list-style-type: none"> <li>• 3/C in-line splices—armored</li> </ul>	HVSA-3-1520S (15 kV) HVSA (5–35 kV) MCK-5 (5/8 kV)	● ● ●	
	<ul style="list-style-type: none"> <li>• Sealed motor connections</li> <li>• 2 wire pigtail splices</li> </ul>	CSJA-3-1520-ARMR CSJA-3-2820-ARMR CSJA-3-3520-ARMR GelCap 8 motor connection		● ● ● ●







## 1/C Unjacketed &amp; Jacketed URD Power Cable (15-35 kV)



	Application(s)	Product(s)	Heat-Shrink	Cold-Applied
	• Indoor heat-shrinkable unjacketed or jacketed terminations (in enclosures)	HVT-150-J (15 kV) HVT-250-J (25 kV)	• •	
	• Indoor cold-applied terminations (15-35 kV)	HVT-350-J (35 kV) TFT-150-E (15 kV) TFT-250-E (25 kV) TFT-350-E (35 kV)	•	• • •
	• Outdoor heat-shrinkable unjacketed or jacketed terminations (weather-exposed)	HVT-150-SJ (15 kV) HVT-250-SJ (25 kV) HVT-350-SJ (35 kV)	• • •	
	• Outdoor cold-applied terminations (15-35 kV)	TFT-150-E (15 kV) TFT-250-E (25 kV) TFT-350-E (35 kV)		• • •
	• Unjacketed in-line splices	HVS-1510S (15 kV) HVS-2510E (25 kV) HVS-3510S (35 kV)	• • •	
	• Jacketed in-line splices	HVS-1510S-J (15 kV) HVS-2510E-J (25 kV) HVS-3510S-J (35 kV) CSJG-151X (15 kV) CSJG-281X (25/28 kV) CSJG-351X (35 kV)	• • • •	• • •
	• Unjacketed repair splices	HVS-1510E-R (15 kV) HVS-2510E-R (25 kV) HVS-3510S-R (35 kV)	• • •	
	• Jacketed repair splices	HVS-3510S-R (35 kV) HVS-3510S-RJ (35 kV) HVS-1510E-RJ (15 kV) HVS-2510E-RJ (25 kV)	• • • •	
	• Sealing of live ends	HVES-1520D (15 kV) HVES-2520D (25 kV)	• •	
	• Jacket/elbow sealing	ESA RVS-SK GelWrap ES Splice Closure CES	•	• • •
	• Jacketed cable grounding kits	JGK-MS (15-35 kV)	•	







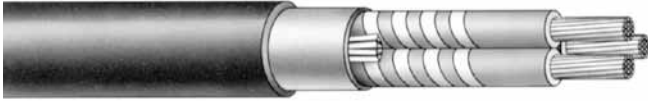

**Paper-Insulated, Lead-Covered (PILC) Cable/  
Varnished Cambric-Insulated, Lead-Covered (VCLC) Cable**

	Application(s)	Product(s)	Heat-Shrink	Cold-Applied
	<ul style="list-style-type: none"> <li>• 1/C PILC indoor/outdoor terminations</li> </ul>	HVT-1590-G/SG (15 kV)	•	
	<ul style="list-style-type: none"> <li>• 1/C PILC-to-PILC splices</li> <li>• 1/C PILC-to-poly transition splices</li> </ul>	HVS-1580D (15 kV) HVS-2580E (25 kV) HVS-3580D (35 kV)	• • •	
	<ul style="list-style-type: none"> <li>• 1/C PILC-to-poly transition “reducer” splices</li> </ul>	HVSR-1580 (15 kV) HVSR-2580E (25 kV)	• •	
	<ul style="list-style-type: none"> <li>• Wye splices (PILC-to-PILC splices or PILC-to-poly transition splices)</li> <li>• H-tap splices</li> </ul>	HVSY-1580D (15 kV only)  HVSH-1580 MOD (15 kV)	•  •	
	<ul style="list-style-type: none"> <li>• Sealing of live ends</li> </ul>	HVES-1520D (15 kV) HVES-2520D (25 kV)	• •	
	<ul style="list-style-type: none"> <li>• 1/C PILC elbow adapter</li> </ul>	HVE-1590 (15 kV) Adapter for 1/C PILC elbows	•	
	<ul style="list-style-type: none"> <li>• Lead repair kit for PILC cables</li> </ul>	HVS-LR	•	

## Cable Type



**Paper-Insulated, Lead-Covered (PILC) Cable/  
Varnished Cambric-Insulated Lead-Covered (VCLC) Cable**

	Application(s)	Product(s)	Heat-Shrink	Cold-Applied
	• 3/C PILC indoor/outdoor terminations	HVT-3-1590-G/SG (15 kV)	●	
	• 3/C PILC to 3/C PILC splices	HVS-3-1590S (shorty-15 kV) HVS-3-1590 (15 kV) HVS-3-2590 (25 kV)	● ● ●	
	• 3/C PILC to three 1/C poly trifurcating transition splices • 3/C PILC to 3/C poly • 3/C PILC to 3/C poly armor	HVS-T-1580S (15 kV) HVS-T-2580D (25 kV) HVS-T-3580S (25 kV) HVS-3-1580S (15 kV) HVSA-3-1580S (15 kV)	● ● ● ● ●	
	• 3/C PILC to three 1/C poly trifurcating transition "reducer" splices	HVSR-T-1580 (15 kV) HVSR-T-2580E (25 kV)	● ●	
	• 3/C PILC to three 1/C PILC trifurcating splices	HVS-T-1590S (15 kV)	●	
	• Sealing of live ends	HVES-3-1590 (15 kV) HVES-3-2590 (25 kV)	● ●	
	• Lead repair kit	HVS-LR	●	

Flexible Cable (Up to 2 kV)

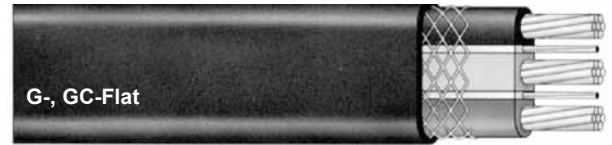

	Application(s)	Product(s)	Heat-Shrink	Cold-Applied
	<ul style="list-style-type: none"> <li>Sealed, in-line splices</li> <li>Multiconductor splices</li> </ul>	LV-MSK	●	
	<ul style="list-style-type: none"> <li>General wraparound sealing</li> </ul>	MRS	●	
	<ul style="list-style-type: none"> <li>Cable jacket repair</li> </ul>	CRPS		

Flexible Cable (5-25 kV)



	Application(s)	Product	Heat-Shrink	Cold-Applied
	<ul style="list-style-type: none"> <li>Indoor terminations (in enclosures)</li> <li>Outdoor (weather-exposed) terminations (5–25 kV)</li> </ul>	HVT-M	●	
	<ul style="list-style-type: none"> <li>Sealed, in-line 3/C splices (5–8 kV)</li> </ul>	HV-MSK	●	
	<ul style="list-style-type: none"> <li>Insulation (2 kV) and jacket repair</li> <li>General wraparound sealing</li> </ul>	MRS	●	
	<ul style="list-style-type: none"> <li>Cable jacket repair</li> </ul>	CRPS		

Bus Insulation Configuration

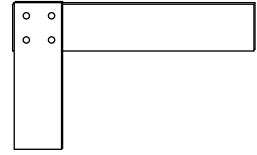
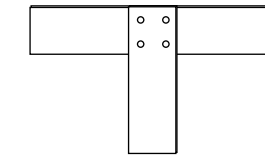
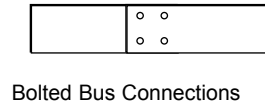
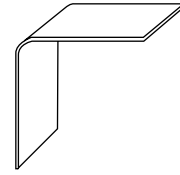
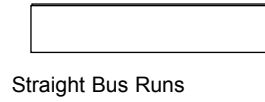
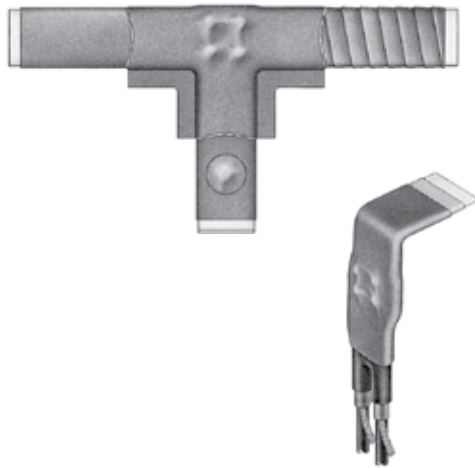

	Application(s)	Product(s)
	<ul style="list-style-type: none"> <li>Bus insulation—slide-on access required</li> </ul>	LVIT BPTM/BBIT
	<ul style="list-style-type: none"> <li>Bus insulation—slide-on access not required</li> </ul>	LVBT HVBT
	<ul style="list-style-type: none"> <li>Field-fabricated insulating covers</li> </ul>	HVIS

Cable-to-Bus Connection Configurations  
1-4 Cable(s) Phase

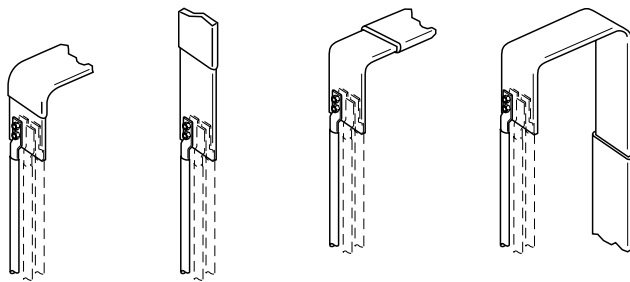

	Application(s)	Product
	<ul style="list-style-type: none"> <li>Switchgear in-line cable-to-bus connections</li> </ul>	HVBC

## Low-Voltage Tubing and Wraparound Sleeves

### General Purpose Cable Accessories (1000 V)

TE offers a complete line of Raychem brand general purpose heat-shrinkable and cold-applied power cable accessories that consistently provide outstanding mechanical protection, complete moisture sealing, and excellent electrical insulation for a broad range of low voltage applications.

### Heat-shrink Products

Raychem invented heat-shrinkable products in 1959 and the Raychem brand continues to be the world leader in heat-shrink technology and design. Our heat-shrink products continue to be upgraded and improved to provide the best performance and value possible.

### Rugged mechanical protection—every time

The tough, abrasion-resistant, cross-linked polyolefin construction of general-purpose products provides mechanical protection equal to the cable jacket. In addition, the one-piece solid protective layer cannot unravel or slip off.

### Watertight seals—every time

Most heat-shrinkable products are coated with a high-performance adhesive that melts and flows when heated, forming a durable bond that seals out water and dirt.

General purpose sealants are also available for use with uncoated tubings and other moisture sealing applications.

### Superior electrical insulation—every time

Heat-shrinkable products not only conform tightly to the connection, but they are also pre-engineered to shrink consistently to the required insulation thickness.

### Cold-applied Products

Cold-applied products offer superior sealing and electrical insulation. Our revolutionary PowerGel sealant provides the best and quickest cold-applied seal. By combining the properties of solids and liquids, PowerGel sealant conforms to intricate shapes to completely seal out water and contaminants.



**Material Properties**

Test Method	Test Method	WCSM Heavy Wall	FCSM Heavy Wall	MWTM Medium Wall	RNF-100 Thin Wall	CRSM Wrap-Around
<b>Physical</b>						
Tensile strength	ASTM D 412	1750 psi min.	1750 psi min.	2000 psi min.	1500 psi min.	2450 psi min.
Ultimate elongation	ASTM D 412	350% min.	350% min.	350% min.	200% min.	350% min.
Accelerated aging (168 hrs at 150°±2°C)	ASTM D 2671					
Tensile strength	ASTM D 412	1750 psi min.	1600 psi min.	2000 psi min.		2000 psi min.
Ultimate elongation	ASTM D 412	350% min.	200% min.	300% min.		300% min.
Low-temperature flexibility (4 hrs. at temp. indicated)	ASTM D 2671	No cracking (-55°C)	No cracking (-40°C)	No cracking (-40°C)	No cracking (-55°C)	No cracking (-40°C)
Flammability	ASTM D 2671		(60 sec max.)		Self-extinguishing	
<b>Electrical</b>						
Dielectric strength (at 0.04 inch)	ASTM D 149 (at 0.10 inch)	430 V/mil min. (at 0.04 inch)	330 V/mil min.	500 V/mil min. (at 0.04 inch)	500 V/mil min.	500 V/mil min.
Volume resistivity ohm-cm min.	ASTM D 257 ohm-cm min.	1 x 10 <sup>12</sup> ohm-cm min.	1 x 10 <sup>13</sup> ohm-cm min.	1 x 10 <sup>12</sup> ohm-cm min.	1 x 10 <sup>14</sup>	1 x 10 <sup>12</sup>
<b>Chemical</b>						
Resistance to liquids	ASTM D 543	●	●	●		●
Tensile strength	ASTM D 412	1450 psi min.	1600 psi min.	2000 psi min.	1000 psi min.	2000 psi min.
Ultimate elongation	ASTM D 412	300% min.	300% min.	300% min.		300% min.
Corrosive effect (16 hours at 150°±2°C)	ASTM D 2671	No corrosion			No corrosion at 175°C	
Fungus resistance	ASTM G 21	Pass rating 1	Pass rating 1	Pass rating 1	Pass rating 1	Pass rating 1
<b>Technical specifications</b>						
ANSI C119.1-1986		●	●			●
UL 486D-1986		●				
UL Standard 224					●	
CSA 22.2		●			●	
Western Underground Guide 2.5		●				
MIL-I-23053/15, Class 1 & 2					●	
Flame-retardant per IEEE 383, ICEA-S-19-81			●			

\*Flame-Retardant

Note: Blank space indicates that property was not measured during product qualification.



**Material Properties**

Physical	Test method	MCK	ESC	CBR
Tensile strength	ASTM D 412	1450 psi min.	1750 psi min.	1500 psi min.
Ultimate elongation	ASTM D 412	300% min.	200% min.	300% min.
Accelerated aging (168 hours at temperature indicated)	ASTM D 2671			
Tensile strength	ASTM D 412	1000 psi min. (175°±2°C)	1750 psi min. (150°±2°C)	1250 psi min. (150°±2°C)
Ultimate elongation	ASTM D 412	200% min. (175°±2°C)	200% min. (150°±2°C)	100% min. (150°±2°C)
Low-temperature flexibility (4 hours at -40°±3°C)	ASTM D 2671	No cracking	No cracking	No cracking
Flammability	ASTM D 635	Self-extinguish (120 sec. max.)		

**Electrical**

Dielectric strength (at .075 inch)	ASTM D 149	250 V/mil min.	200 V/mil min.	250 V/mil min.
Volume resistivity	ASTM D 257	1 x 10 <sup>12</sup> ohm-cm min.	1 x 10 <sup>12</sup> ohm-cm min.	1 x 10 <sup>12</sup> ohm-cm min.

**Chemical**

Resistance to liquids, transformer oil to VDE 0370 (168 hours at 23°±2°C)	ASTM D 543			
Tensile strength	ASTM D 412	1150 psi min.	1750 psi min.	1250 psi min.
Ultimate elongation	ASTM D 412	240% min.	200% min.	240% min.
Corrosive effect(16 hours at 175°±2°C)	ASTM D 2671	No corrosion		
Resistance to fungi	ASTM G 21	Pass rating 1	Pass rating 1	Pass rating 1

**Technical specifications**

ANSI C119.1-1986		•	•	
Flame-retardant per IEEE 383, ICEA-S-19-81		•		

Note: Blank space indicates that property was not measured during product qualification.

**Material Properties**

Physical	Test Method	S1052	S1085	S1171	S1174	S1251
Softening point	ASTM E 28	70°C min.		140°C min.	140°C min.	
Adhesive peel strength:						
Polyethylene		1 lb/in min.	5.5 lb/in min.		5 lb/in min.	6 lb/in min.
Steel		2 lb/in min.			5 lb/in min.	
Aluminum			4.4 lb/in min.			
Copper			4.4 lb/in min.			
Low-temperature flexibility (4 hours at temperature indicated)	ASTM D 2671	No cracking (-40°C±3°C)	No cracking (-30°C±2°C)		No cracking (-40°C±3°C)	No cracking (-40°C±3°C)

**Electrical**

Dielectric strength min. (0.04 inch)	ASTM D 149	300 V/mil min.	200 V/mil min.	200 V/mil min.	300 V/mil min.	300 V/mil
Volume resistivity	ASTM D 257	1 x 10 <sup>12</sup> ohm-cm min.	1 x 10 <sup>12</sup> ohm-cm min.	1 x 10 <sup>12</sup> ohm-cm min.	1 x 10 <sup>12</sup> ohm-cm min.	1 x 10 <sup>12</sup> ohm-cm min.
Tracking & erosion resistance	ASTM D 2303		No tracking or erosion to top surface or flame failure after: 1 hr at 2.00 kV 1 hr at 2.25 kV 1 hr at 2.50 kV			

**Chemical**

Corrosive effect (16 hours at 121°±2°C)	ASTM D 2671	No corrosion		No corrosion	No corrosion	
Fungus resistance	ASTM G 21	Pass rating 1			Pass rating 1	

Note: Blank space indicates that property was not measured during product specification.

**Material Properties**

<b>PowerGel Testing</b>	<b>Test Methods</b>	<b>S.I. Units</b>	<b>Imperial Units</b>
Dielectric strength (4 mm/016 inch wall thickness)	40 kV/cm min.	100 V/mil min.	
Volume Resistivity	1 x 10 <sup>12</sup> Ohm cm min.	1 x 10 <sup>12</sup> Ohm cm min.	
Resistance to Liquids Chemicals: 1 N na2SO4 0,1 N NaOH; 0, 1 N NaCl; water; Ethylene Glycol	ASTM D543 modified: 10.0 cm x 1.0 cm x 0.4 cm, test bar supported on wire mesh, 24 hours immersion, IPA rinse after immersion, 24 hr. drying	No visible cracking, max. 2% weight change, 80% retention of elongation and tensile strength	No visible cracking, max. 2% weight change, 80% retention of elongation and tensile strength
Corrosive Effect	ASTM D2671	No corrosion	No corrosion
Resistance to Fungi 4.5 cm diameter x 0.4 cm thickness petridish	ISO 846	Pass rating1 or less	Pass rating 1 or less
UV Resistance 10.0 cm x 1.0 cm x 0.4 cm est bar, UVB 313; 250 cycles (2000 hrs); 4 hours UV at 60°C then 4 hours at 50°C with condensation	ISO 4892/3	80% tensile strength retention, no visible cracking	80% tensile strength retention, no visible cracking



Polymeric wye and H-tap splices produce dependable water tight seals between the main and tap cable(s) with no taping.



Heat-shrink, high-voltage splice kits install quickly and uniformly.

**Superior Long-Term Performance**

Even in the harshest environments, TE's Raychem brand cable splices are ideal for the following direct-burial and manhole applications: copper tape, wire shield, UniShield, LC-shield, PILC, and jacketed/unjacketed URD cables. The splices not only match the requirements of cable test specifications but also meet or exceed the requirements of IEEE-404. Throughout the world, TE Raychem splices are meeting the needs of industrial, utility, and mining customers with outstanding performance and reliability.

**Positive Moisture Sealing and High Abrasion-Resistance**

Internal moisture seals protect the cable from water that may enter the cable through a damaged jacket outside of the splice area. In addition, the adhesive-lined re-jacketing sleeve provides a moisture-resistant seal that is field-tested and superior to interference fits. Underwater cyclic aging tests per ANSI C119.1-1986 and IEEE 404 specifications confirm this. In addition, the outer jacket is superior to tape in abrasion resistance and cannot unravel or fray.

**Fast, Consistent Installations**

Simple heat-shrinking techniques reduce installation time and training. Pre-engineered kits help to ensure consistent performance while minimizing potential installation errors.

**Unique Repair Splices**

Specially designed to speed URD cable repair, TE's Raychem brand URD repair splices reduce cable preparation and required excavation space, thus minimizing total repair costs. With our superior heat-shrink adhesive system, our splices reliably seal fault-deformed cables. In addition, one splice repair kit may replace two conventional splices for most repairs.

The typical TE Raychem brand splice—based on heat-shrink technology, specialized materials, and pre-engineered designs—delivers reliable performance.

A close look at one of our polymeric cable splices shows how each component draws on TE technical excellence and field experience to rebuild every function of the cable.

All cable splices must rebuild these critical cable functions:

- Electrical stress control
- Insulation and semiconductive layer
- Shielding and grounding
- Environmental and mechanical protection

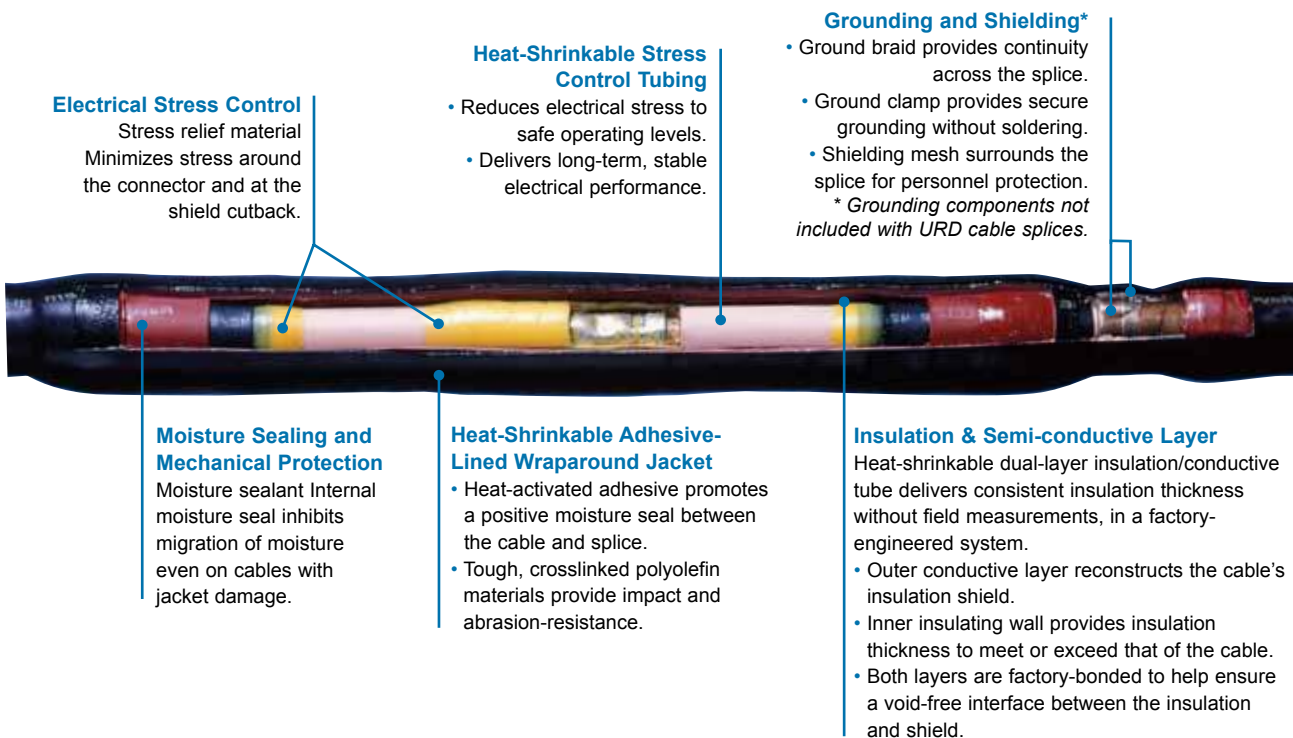

## Splices

**Positive, Consistent Oil Stop**

Unlike other oil stops, TE Connectivity unique system combines heat-shrinkable, high temperature oil barrier tubing and oil blocking stress relief material (SRM) to avoid splice failures due to oil leakage.

**Long-Term Reliability**

Both the component materials and the complete splices have undergone rigorous, long-term test programs, including pressurized load-cycling to maximum cable system overload temperatures.

**Elimination of Lead Sleeve Failures**

Moisture is the worst enemy of PILC cable systems. A major source of leakage problems is cracking of lead sleeves and wipes due to cable flexing or corrosion. TE's design replaces these components with heavy-duty, heat-shrinkable jacketing and adhesive seals, so moisture problems are minimized.

**Field-Tested Performance**

Since TE "converts" the PILC cable to a "polymeric equivalent," all TE's designs can then use the effective components found in our plastic cable splices. For more than a decade, these products have compiled an excellent service history in more than a million installations worldwide.

**Easy, Consistent Installations**

By "converting" the PILC cable to a "polymeric equivalent," these TE's Raychem brand kits eliminate compound-filling and difficult lead-wiping. Also, heat-shrinking means no time-consuming insulation, stepping or penciling, hand taping, and stress cone building.

**Reduced Installation and Training Time**

You get on and off the job site quicker. There's no lead-wiping, no compound pouring, and no waiting for "cool downs" and "top-ups." Time and cost are drastically reduced, with users reporting installation cost savings of up to 75 percent.

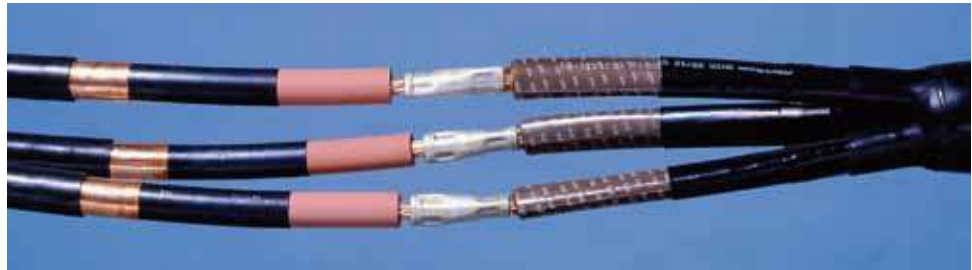

To produce a simple, field-tested oil stop system, TE's Raychem brand splices utilize high-temperature oil barrier tubing and oil-blocking stress relief material.

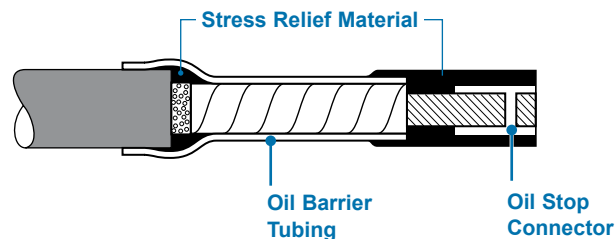
**Easy to Install Wye Splices**

PILC wye splices produce water-tight seals between the main and tap cable with no tedious, complex taping. The simple construction does not require lead wiping, so installation is fast and easy. These splices are versatile, accommodating both PILC-to-PILC and PILC-to-polymeric constructions.

**Breakout Seal**

Heat-activated sealants combine with heat-shrinkable components to produce a field-tested moisture resistant system for the critical branch breakout area.

**Intercable Insulation**

A soft (pliant) preformed profile conforms tightly to the cable surfaces upon shrinking. This provides insulation in the area between the main and branch (or tap) cable.

**Positive Oil Stop Systems for 3/C Cables**

TE provides a highly effective and easily installed oil stop system, using standard heat-shrinkable components:

- Adhesive-lined, conductive breakout
- Converts the 3/C cable into three 1/C cables
- Provides an oil- and pressure-resistant seal
- Grounds the conductive tubing to the lead sheath

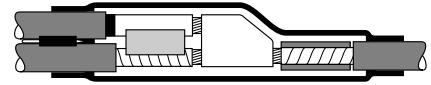

**Oil Blocking Stress Relief Material**

- During shrinking, the material softens and conforms around the individual conductors forming an oil-resistant seal
- Provides electrical stress relief between the insulated conductors on belted cable
- Conductive tubing
- Reshields the individual insulated conductors

**Oil Barrier Tubing**

- Locks the oil in the PILC cables, converting each conductor to a polymeric equivalent

**Elastomeric Technology**

The elastomeric splice component is supplied in an expanded form. In this form, the heat-shrinkable outer wall holds the insulating layer at a wide diameter. Application of heat causes the outer wall to shrink, allowing the insulating layer to contract at the same time and closely fit the splice. The rubber-like characteristics of the material enable the splice to follow the thermally induced dimensional changes of the cable insulation.

The elastic memory of the material helps to ensure that the correct insulation-wall thickness is obtained for the defined application range of the component.



**Cable Splice without Stress Control**

The figure below shows a computer-simulated plot of electrical stress in a splice without stress control. Areas of high stress exist near the edge of the semi-con and connector as shown by the concentrations of equipotential lines. These high stresses must be lowered to prevent premature insulation damage and splice failures.

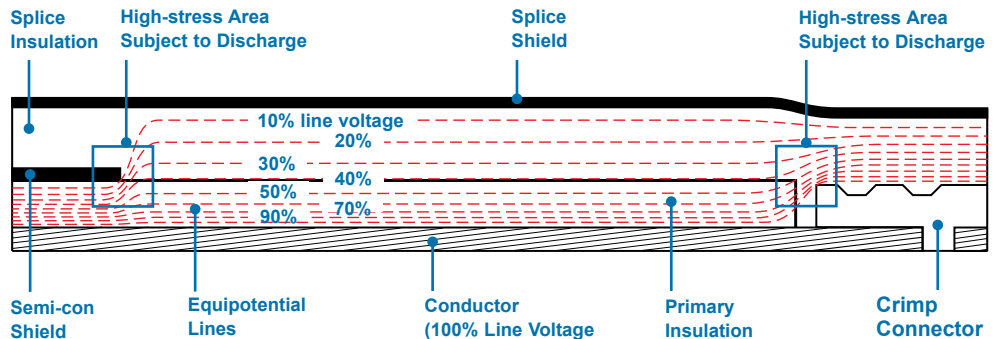

**Cable Splice with Stress Control System**

TE's stress control system controls the distribution of the electrical field in the splice. The equipotential lines are distributed uniformly, reducing the stresses within the splice to levels required for longer service life. This is achieved by the unique resistive and capacitive properties of the heat-shrinkable tubing and stress relief material (SRM).

The stress control materials reduce stress through their electrical properties rather than the geometry of the splice or correct positioning of a Faraday cage. Stress cone buildup is diminished, resulting in a slim, compact splice and significantly decreasing splice installation time.

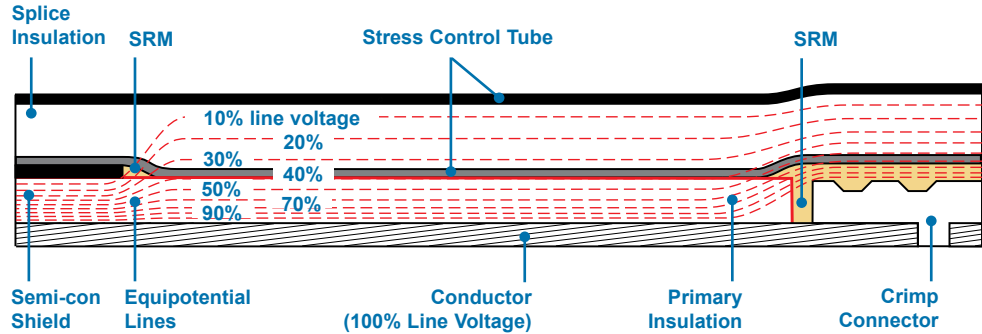

**Test and Performance Data for Polymeric and URD Splices**

To help provide long-term reliability and durability, TE's Raychem brand splices have been subjected to extensive testing in both the laboratory and actual field environments. Kits are factory-designed and tested to meet cable system requirements as summarized in

the table below. Test levels are drawn from relevant sections of existing industry standards, including the following: IEEE 404, IEEE 593, ANSI C119.1 and ANSI C119.4, IEEE 386, AEIC CS5, AEIC CS6

Test Description	HVS-8XX (5–8 kV)	HVS-15XX (15 kV)	HVS-25XX* (25 kV)	HVS-35XX (35 kV)	EHVS69XX (46/69 kV)
Partial discharge (min. kV) for 3 pC or less	7	13	22	30	60
AC withstand, 1 min (kV)	23	35	52	69	120 (15 min)
AC withstand, 5 min (kV)	21	39	65	90	N/A
AC withstand, 5 hr (kV)	16	31	50	71	100 (6 hr)
DC withstand, 15 min (kV)	45	75	105	140	240
Impulse withstand 1.2 x 50 μs (crest kV)	95	110	150	200	350
Water sealing properties**	Pass	Pass	Pass	Pass	

\* Also meets requirements of 25/28 kV systems.

\*\*Refer to EDR-5101, "A Survey of the Water Sealing Properties of Raychem brand Heat-Shrinkable Splices" for testing details. IEEE 404 requires testing without jacket installed for load cycling under water. All TE heat-shrink splices pass this new requirement.

**Recommended Guide Specification for Polymeric and URD Splices (5–35 kV)**

Please feel free to use the following in your design specification:

Power cable splices for nonshielded or shielded solid dielectric cable and unjacketed or jacketed URD (concentric neutral) cable shall be factory-engineered kits that rebuild the primary cable insulation, shielding and grounding systems, and outer jacket equivalent to that of the original cable.

When assembled on cable, the splice shall be capable of passing the electrical test requirements of IEEE-404 and the water immersion tests of ANSI C119.1.

Splices shall be of a uniform-cross-section, heat-shrinkable polymeric construction utilizing an impedance-layer stress control tube and high-dielectric-strength insulating layers.

The outer insulating layer shall be bonded to a conducting layer for shielding. The splice shall be re-jacketed with a heat-shrinkable adhesive-lined sleeve to provide a waterproof seal.

The splice shall accommodate a range of cable sizes and be completely independent of cable manufacturer's tolerances. Splices shall be capable of being properly installed on out-of-round cable per relevant ICEA and AEIC standards. Kits shall accommodate a range of commercially available connectors.

Splices for armored cables shall provide a means of reinstating the armor over the span of the installed splices. Wye splices shall include a sealant profile to seal the area between the branch and the main cable.

The splice manufacturer shall provide a test report demonstrating compliance with the above requirements. Splices shall be manufactured by TE or approved equivalent.

#### Test and Performance Data for PILC Splices

PILC splices are fully engineered to provide a long, trouble-free service life. They are factory-designed and tested to meet PILC cable system requirements, as summarized in the table below.

Test levels are drawn from relevant sections of existing industry standards, including those that follow:

- IEEE 404 (power cable splices)
- IEEE 48 (terminations)
- AEIC-1 (paper cable)
- AEIC-CS5 (XLPE cable)
- AEIC-CS6 (EPR cable)
- ANSI C119.1 (sealed insulated underground connection system)

#### Test and Performance Data for PILC Splices

Electrical	Voltage Class		
	15 kV	25 kV	35 kV
AC withstand test, 6 hours	35 kV	58 kV	80 kV
DC withstand test, 15 minutes	55 kV	75 kV	100 kV
Impulse withstand (BIL) 1.2 x 50 $\mu$ s	110 kV	150 kV	200 kV

#### Load Cycle/Pressure

Current load cycling <sup>1</sup> , 2 cycles of 5 hours heating, 3 hours cooling to conductor temperature of 110°C with applied overvoltage and maximum continuous internal oil pressure; no breakdown, oil leakage	Pass	Pass	Pass
Maximum continuous internal oil pressure	15 psig	15 psig	15 psig
Maximum continuous conductor temperature	90°C	90°C	90°C
Maximum overload conductor temperature	110°C	110°C	110°C

#### Sealing

Water immersion outer jacketing system	ANSI C119.1	ANSI C119.1	ANSI C119.1
Proof test on oil blocking system: TE test method—no oil diffusion	Pass	Pass	Pass

1. Not applicable to live end seals.
2. Maximum continuous/emergency conductor temperature for wye splices: 70°C.
3. Test methods discussed in IEEE paper 84 T&D 340-6, "The extension of heat-shrinkable components for use with 1/C transition and paper cable splices," by Mackevich, et al.

#### Recommended Guide Specification for PILC Splices (15–35 kV)

Please feel free to use the following in your design specification: Splices shall be factory-manufactured kits to suit the specific type and size of the cables to be spliced.

The electric field distribution in the splice shall be controlled by a heat-shrinkable tubing having a complex impedance when energized with an AC voltage. A dual-wall tubing with a co-extruded outer conductive layer to form a void-free interface between the insulation and shield shall be used.

Kits shall be factory-engineered to contain all necessary materials, except connector, and provide an oil block and oil seal, electrical stress control, insulation, shielding, and environmental sealing. The kit shall allow for external grounding. Major kit components shall be heat-shrinkable.

The splice insulation shall not require a lead sleeve, lead wipe, or any kind of filling.

The splice manufacturer shall provide a test report, upon request, demonstrating that the splice performance is equivalent to the cables per relevant sections of IEEE-404, AEIC-1. Splices shall be load cycled with 15 psig internal oil pressure at 2.5x rated line-to-ground voltage at 110°C emergency overload rating. Splices shall also be subjected to a voltage withstand test sequence per listed standards.

Wye splices on PILC cable shall be tested to the requirements of ANSI C119.1. The test shall demonstrate the mechanical integrity, water sealing, and electrical properties of the outer jacket system.

Splices shall be manufactured by TE Connectivity or approved equivalent.

## Terminations



TE proven oil-sealing technology has been used for more than 18 years in medium-voltage transition joints. This technology is now put to work in our PILC termination kits.

**Reliable, Field-Proven Performance**

Independent testing and field experience have repeatedly proven the long-term stability, durability, and reliability of the TE's Raychem HVT system, even in highly polluted environments. The nontracking, insulating outer jacket can withstand the rigors of long-term electrical stress and surface pollution without loss of performance. The nontracking material offers the additional benefit of being maintenance free, with no need for periodic cleaning. Extensive load cycle testing verifies the long-term thermomechanical compatibility between the termination system and the cable.

**Ease of Installation**

HVT kits can be installed on all cable types without special adapters or accessories. No special tooling or connectors are required since HVT kits accept all common compression or terminal lugs. The HVT installation method also provides generous cable cutback and component positioning tolerances, further reducing installation variability. Heat-shrinking allows the kits to be easily inspected, either visually or by simple touch, to help ensure proper installation.

**Always Ready for the Job—Even in Emergencies**

HVT kits have an unlimited shelf life. They remain ready to use on short notice, so you have no worries about scrapping aged inventory or being caught with useless products during an emergency or on a time-critical project.

**Flexible and Versatile**

An HVT system may be installed upright or inverted and can bend to the same bending radius as the cable. Slim and lightweight, the system can also be mounted directly to fuse cutouts or other devices, eliminating the cost of additional supporting brackets and cross arms.

**46 and 69 kV**

At voltages as high as 69 kV the need for proven stress control is even more important. The materials used in our 46 and 69 kV terminations (as with all lower voltages) are suitable for severely polluted areas—and for all installation conditions, including top feed installation.

The material is designed to be resistant to impact damage from transportation or vandalism, a typical problem for heavy, inflexible porcelain products. TE Connectivity Raychem brand 46/69 kV terminations also require no compound filling which can leak over time.

**Cold-Applied Termination System**

TFT terminations are designed for customers who want TE material technology in a cold-applied system. The cold-applied terminations also provide positive positioning of the stress control patch.

TE's Raychem brand HVT system features a nontracking, insulating surface that can withstand long-term electrical stress and surface pollution.





**HVT**

**Shielding and Solderless Grounding  
(included in polymeric cable kits except URD)**

**Moisture Sealing**

- Nontracking, high-voltage sealant:
- Provides a watertight connector seal when combined with heat-shrinkable material
  - Will not harden or crack

**Additional Creepage for Outdoor Applications**

- Heat-shrinkable skirts:
- Increase surface creepage distance
  - Easily adapt terminations for outdoor use
  - May be inverted for terminations facing downward

**Electrical Stress Control and Insulation  
(8 kV and up)**

- Heat-shrinkable stress control tubing:
- Reduces the electrical stress gradient at the end of the cable shield to safe operating levels
  - Shrinks to fit out-of-spec cable
  - Provides long-term electrical performance

**Nontracking, Heat-Shrinkable Outer Insulation Tubing**

- Provides excellent UV stability
- Withstands polluted environments
- Is proven to withstand severe application

**Stress relief material**

- Minimizes stress at the shield cutback
- Applies easily, smoothing the step at the cable semi-con edge and filling any voids
- Acts as a secondary moisture sea

**Ground Braid**

- Provides shield continuity

**Ground Clamp**

- Has a constant-force roll spring, which provides secure grounding without soldering

**Moisture Sealing**

- Nontracking, high-voltage sealant

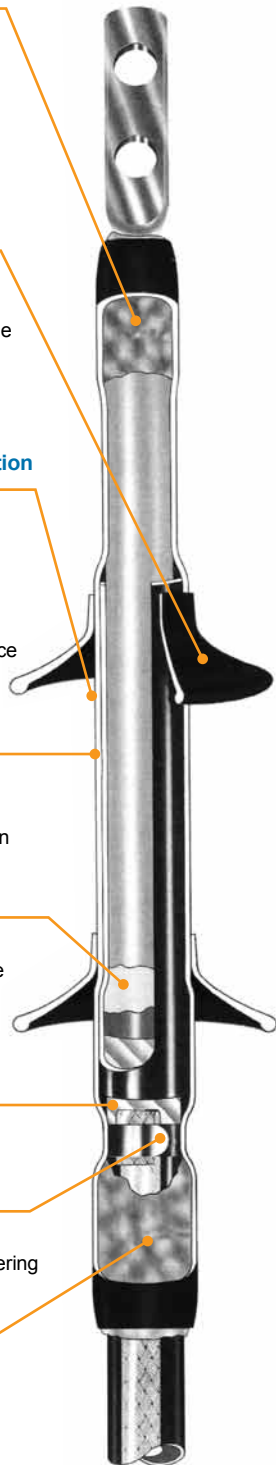

**TFT**

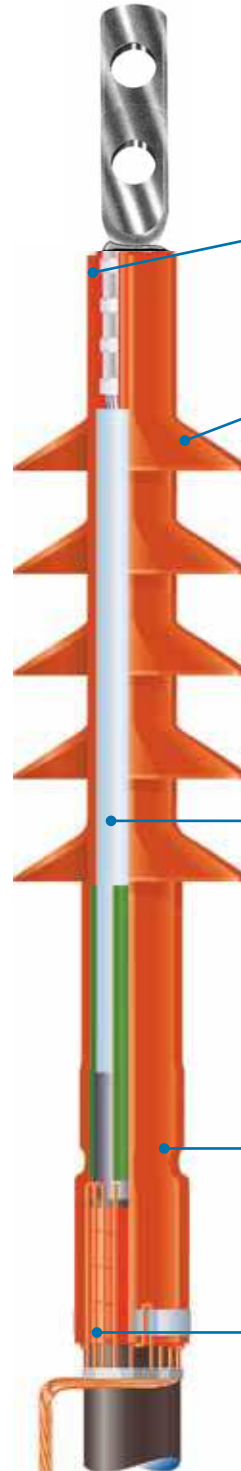

**Moisture Sealing**

- Nontracking, high-voltage sealant:
- Provides a watertight connector seal
  - Will not harden or crack

**Additional Creepage for Outdoor Applications**

- Molded skirts:
- Increase surface creepage distance

**Electrical Stress Control**

- Metal Oxide Matrix stress control patch:
- Reduces the electrical stress gradient at the end of the cable shield to safe operating levels
  - Conforms to fit out-of-spec cable
  - Provides long-term electrical performance

**Nontracking, Termination Body**

- Provides excellent UV stability
- Withstands polluted environments
- Is proven to withstand severe applications

**Moisture Sealing**

- Nontracking, high-voltage sealant spring clamp and solder-block ground braid available for metallic shielded cables

**HVT Testing Data**

TE's Raychem brand high-voltage terminations are fully qualified per IEEE-48 as Class I terminations to provide a long, trouble-free service life. Independent testing and field experience have repeatedly proven the long-term durability, reliability, and stability of the HVT system, even in highly polluted environments. TE's proven nontracking, insulating jacket can withstand the rigors of long-term electrical stress and surface pollution without loss of performance. The nontracking material is maintenance free and does not require periodic cleaning. Extensive load-cycle testing verifies the thermomechanical compatibility between the termination system and cable.

**Recommended Guide Specifications**

Please feel free to use one or all of the following in your design specifications:

**Medium-Voltage Terminations (through 69 kV)**

Shielded power cable termination kits shall be factory engineered for the application. The kits shall consist of high-permittivity, high-resistivity, heat-shrinkable stress control tubing, and outer insulation tubing and skirts (outdoor applications) made from UV-stable, nontracking (per ASTM D 2303) materials. Heat-activated sealant materials to help prevent moisture ingress and contamination should also be included. Termination kits shall meet or exceed all rating requirements of IEEE-48 for Class I terminations and the test sequence prescribed by IEEE-404, including 130°C load cycling and 130°C impulse withstand.

**Multi-Conductor Shielded Cable Terminations**

In addition to the phase terminations, multi-conductor termination kits shall provide a heat-shrinkable breakout boot, factory-coated with sealant for strain-relief and sealing purposes. Each kit shall include lengths of heat-shrinkable tubing to help prevent corrosion and shifting of the shielding layers between the boot and the phase-termination installation point.

When grounding and/or ground check conductors are included, the kit includes lengths of heat-shrinkable tubing and sealant material to seal each conductor from the boot to its connection point.

**Nonshielded Cable Terminations (2–5 kV)**

Termination kits for nonshielded power cables installed in contaminated indoor or outdoor environments are factory engineered to provide UV-stable, nontracking (per ASTM D 2303 and the Ontario Hydro accelerated tracking wheel test) exterior surfaces and complete environmental sealing for the termination area. Termination kits shall consist of heat-shrinkable tubing, skirts (outdoor applications), and sealing boots (for 3/C only) supplied with heat-activated sealant materials to help prevent moisture ingress and contamination.

**Product and Voltage Class 1**

Test Description	HVT-80 (5–8 kV)	HVT-150 (15 kV)	HVT-250 (25 kV)	HVT-350 (35 kV)	EHVT-460 (46 kV)	EHVT-690 (69 kV)
AC withstand, 1 minute, (kV)	35	50	65	90	120	175
DC withstand, 15 minutes, (kV)	65	75	105	140	170	245
Partial discharge (min. kV) for 5 pC or less	9	13	21.5	30	40	60
Impulse withstand 1.2 x 50 µs, crest kV (outdoor)	95	110	150	200	250	350
Impulse withstand 1.2 x 50 µs, crest kV (indoor)	80	95	125	150	250	350
Continuous current rating	Equal to cable ampacity					
Wet withstand, 10 seconds, kV rms	30	45	60	80	100	145
Dry withstand, 6 hours, kV rms	25	35	55	75	100	120

**Electrical Stress Control**

Shielded power cables require electrical stress control when terminated. When the insulation shield is removed from a cable, the electrical field is concentrated at the cutback point, causing high electrical stress. If the stress is great enough, it can cause the air to break down, resulting in corona. High-stress areas also cause internal discharges. Corona or internal discharges will ultimately destroy the cable insulation, causing premature failure.

**Cable Termination Without Stress Control**

The diagram below shows an energized cable termination without stress control. The electric field intensity is greatest where the equipotential lines (line of constant voltage) are concentrated. Note the concentration near the edge of the semi-con shield. Stress control is required here to reduce the electrical stress below levels at which the air would break down or discharges would occur in the insulation.

**Cable Termination with TE's Unique Stress Control System**

With TE's stress control tube installed, the equipotential lines are spread out, distributing the electrical field and reducing the electrical stress to the cable insulation's operating level, as shown in the diagram below. This is achieved by the unique resistive and capacitive properties of the heat-shrinkable material. Note that no diameter buildup is required as in a conventional stress cone that utilizes its geometry to reduce stress.

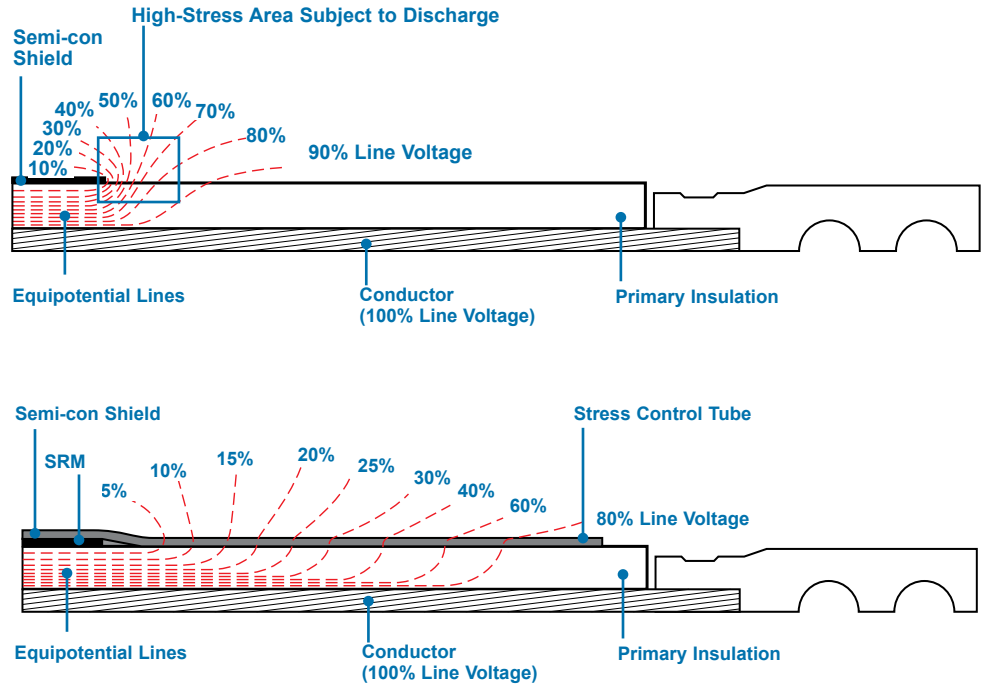

**Recommended Air Clearance (Heat-Shrink and Cold-Applied Products) Phase/Phase and Phase/Ground**

The stress control system provides a linear voltage distribution from the lug at high voltage to the shield termination at ground potential. If the termination is installed too close to another phase termination or grounded metal, the electric stress in the air gap will rise to a level where discharge or flashover may occur. The table and diagrams below indicate the minimum clearances needed between various termination configurations. These clearances are based on IEEE Basic Impulse Levels (BIL).

**Minimum Clearance<sup>1</sup> (inches/millimeters)**

BIL (kV)	A	B	C <sup>2</sup>	D
95 (5-8 kV)	6.5 (160)	3.5 (90)	1.2 (30)	0.8 (20)
110 (15 kV)	7.0 (175)	4.0 (100)	1.4 (35)	0.9 (23)
150 (25 kV)	9.0 (225)	6.0 (150)	1.6 (40)	1.0 (25)
200 (35 kV)	13.0 (325)	9.0 (225)	2.0 (50)	1.4 (35)

<sup>1</sup> Values are based on normal operating conditions. Humid or poorly ventilated environments may require additional air clearance.

<sup>2</sup> For skirted, outdoor terminations, the value for "C" is equal to the distance from the edge of one skirt to another or from a skirt to ground.

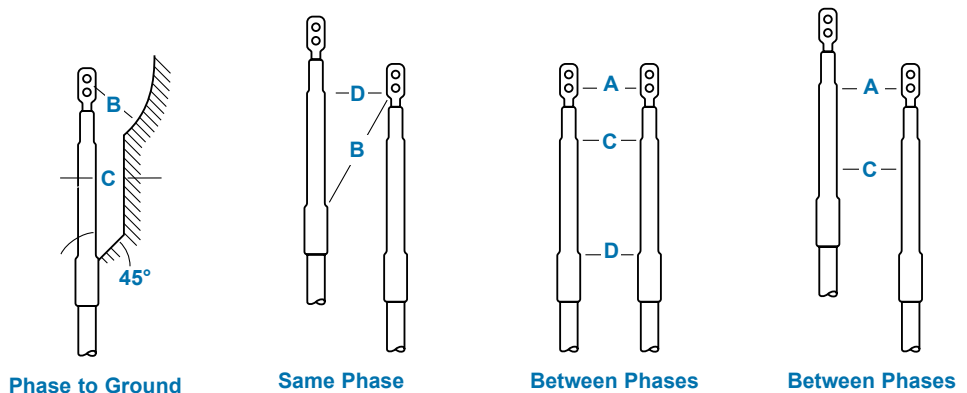

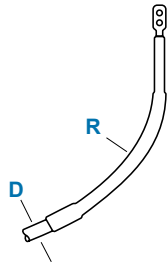

Bending Radius

Recommended cable bending radius TE Connectivity Raychem brand terminations are as flexible as the original cable. A cable end should not be bent to a radius less than that recommended by the manufacturer.

**D** = Cable jacket O.D.

**R** = 10 x D—Minimum bending radius (consult cable manufacturer’s values and check them against TE Connectivity. Select the higher of the two values. Preheat cable to approximately 80°C before bending.)

**TFT Testing Data**

These terminations are fully qualified per IEEE-48 as Class 1 terminations to provide a long, trouble-free service life. These terminations incorporate TE material technology in a cold-applied system. These terminations have an elastomeric tubing that is formulated for long-term performance in typical extreme termination environments. The non-tracking material is maintenance-free and does not require periodic cleaning.

This series of products features the latest in advanced stress control systems using Metal Oxide Matrix technology to provide superior electrical performance.

**Voltage class**

Test description	(5-8 kV)	(15 kV)*	(25 kV)	(35 kV)
AC withstand, 1 minute, (kV)	35	50	65	90
DC withstand, 15 minutes, (kV)	65	75	105	140
Partial discharge (min. kV) for 5 pC or less	9	13	21.5	30
Impulse withstand 1.2 x 50 μs, crest kV (outdoor)	95	110	150	200
Wet withstand, 10 seconds, kV rms	30	45	60	80
Dry withstand, 6 hours, kV rms	25	35	55	75

\*With or without sheds



The Raychem Raysulate electrical insulation family of products offers easy-to-install busbar insulation systems for both the field engineer and the manufacturer. Raysulate electrical insulation products provide flashover protection against the accidental bridging of conductors commonly caused by birds and animals.

The system is ideal for both enclosed and exposed bus work and for connections in switchgear lineups, substations, and other electrical apparatus. It also permits clearance reduction in many applications.

**Excellent Electrical and Thermal Performance**

Raysulate electrical insulation products are manufactured from high dielectric strength, radiation-crosslinked, heat-shrinkable materials. The high-voltage materials are specially formulated to provide high resistance to arcing and tracking. All high-voltage and low-voltage materials provide high-thermal endurance throughout the range of switchgear operating temperatures. They offer field-proven reliability and long service life in harsh environments. In addition, these heat-shrink tubing, tape, and sheet products can be preformed and preshrunk in the customer's shop, allowing easy, quick installation in the field.

**Compatibility with Other Insulating Materials**

All Raysulate heat-shrinkable electrical insulation products are compatible with other solid switchgear insulating materials. Raysulate electrical insulating materials are not subject to stress crazing or embrittlement and are not adversely affected by common plasticizers used in conventional switchgear insulating materials.

**Flame-retardant Materials**

Most Raysulate heat-shrinkable electrical insulating materials pass the ANSI C37.20 switchgear insulation flammability tests.

**Reduced Corrosive and Toxic Fumes**

Raysulate electrical insulation materials contain no chlorine compounds. This minimizes noxious and corrosive effects in case of equipment fault or fire.

**For Protection, Repair, and Maintenance**

Raysulate heat-shrinkable electrical insulating tubes, tapes, and sheets provide a complete system for electrical repair and maintenance of enclosed or exposed buswork and for connections in switchgear and electrical equipment. They offer:

- Fast, easy installation and removal
- A flexible system to cover most conductor shapes and sizes
- Consistent, reliable installation
- Consistent electrical and thermal performance
- Proven corrosion protection
- Compatibility with conventional solid insulating materials
- Protection against flashovers



HVBC Bus Connection Kit

**For the Electrical Equipment Manufacturers**

The Raysulate system of insulation-enhancement components addresses the needs of electrical equipment manufacturers. The superior material properties and versatility of these components enhance the quality and reliability of the final product. Raysulate electrical insulating materials feature:

- Low-hazard formulation
- Flexibility
- Track resistance
- Rugged, easy installation
- Excellent electrical and thermal performance
- Unlimited shelf life
- Corrosion protection of conductor
- TE Connectivity assistance and support for testing and applications

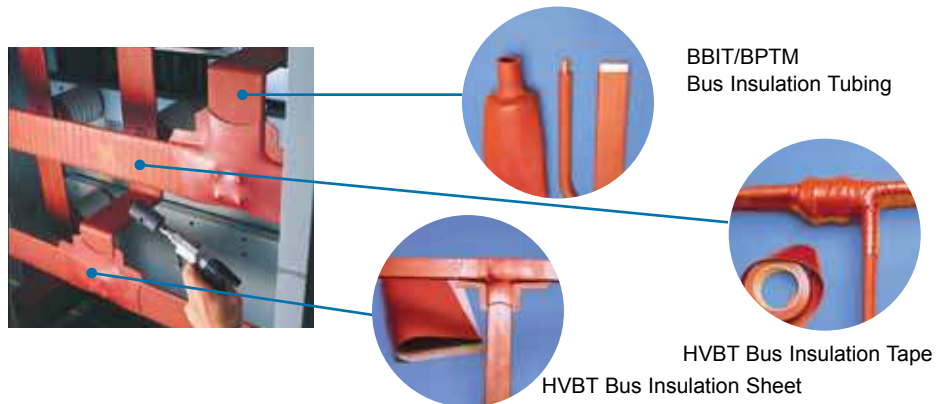

BBIT/BPTM Bus Insulation Tubing

HVBT Bus Insulation Tape  
HVBT Bus Insulation Sheet

**For Outdoor Equipment**

TE's Raychem Raysulate electrical insulation products provide a complete system of insulation enhancement for high-voltage busbars and related equipment in outdoor substations and overhead lines. The system offers:

- Easy installation in the field
- Insulation for many different shapes, including busbars, joints, tees, insulators/bushing connections
- Flashover protection against accidental bridging
- Protection of wildlife and from wildlife-induced outages
- Excellent UV and weathering resistance
- Protection against corrosion
- Protection against incidental tree branch contact



MVLC-18-A/U Overhead Line Cover



MVCC



HVCE



BCAC-IC-8D/18 Bushing Cover



BCAC-G-AR-5D/2 Lighting Arrester Cover



BISG-24

## Medium-Voltage Products\*

### Test and Performance Data

Material Properties	Test Method	Requirements	BBIT BPTM	BCIC HVIS	BCAC, HVCE-WA, HVBT, OLIT	HVCE	MVLC	BISG RRBB
<b>Electrical</b>								
Volume resistivity	ASTM D-257, IEC 93	ohm-cm min.	1.0x10 <sup>13</sup>	1.0x10 <sup>13</sup>	1.0x10 <sup>13</sup>	1.0x10 <sup>13</sup>	1x10 <sup>13</sup>	1x10 <sup>13</sup>
Dielectric constant	ASTM D-150, IEC 250	maximum	5.0	5.0	5.0	5.0	5.0	5.0
Dielectric strength	ASTM D-149, IEC 243	V/mil at 1.3mm min. V/mil at 1.5mm min. V/mil at 2mm min. V/mil at 2.5mm min. V/mil at 3mm min.	500 450 400 350	330	330	250	550	380
<b>Thermal</b>								
Thermal endurance	IEEE 1-1969, IEC 216	minimum	105°C	105°C	105°C**	110°C	105°C	
Accelerated aging for 168 hours	ISO 188	Tensile strength Ultimate elongation Aging Temp.	1450 psi 300% 120°C	1450 psi 300% 120°C	1450 psi. 300% 120°C	1100 psi 300% 120°C	1450 psi 100% 150°C	2450 psi 25% 120°C
<b>Chemical</b>								
Flammability	ANSI C37.20	Pass	Pass	Pass	Pass			
Water absorption	ISO/R 62, procedure A	1% max. after 14 days at 23°C	Pass	Pass	Pass	Pass	Pass	Pass
Low-temperature flexibility	ASTM D-2671, procedure C	No cracking after 4 hr	Pass -40°C	Pass -40°C	Pass -40°C	Pass -40°C	Pass -20°C	Pass -40°C
Corrosion	Copper Mirror, ASTM D-2671, procedure B	Passed visual inspection after 16 hr		Pass 150°C	Pass 150°C		Pass 135°C	
<b>Physical</b>								
Tensile strength	ASTM D-638, ISO 37	psi. (min.)	1450<4 mm, 1150>4 mm	1450	1450	1150	1450	2450
Ultimate elongation	ASTM D-638, ISO 37	% minimum	300	300	300	300	200	25

Note: Blank spaces indicate that property was not measured during product qualification.

\*Each product's voltage rating will be displayed with its selection information.

\*\*Properties measured on backing material only. HVBT and OLIT have a 90°C maximum continuous operating temperature limit.

## Busbar Insulation Technical Data

This table indicates clearance differences for rectangular busbars without and with various Raysulate electrical insulation products. These spacings are derived from BIL, AC-withstand, DC-withstand, and discharge-extinction tests on a limited number of busbar configurations insulated with Raysulate electrical insulation products.

Due to the wide range of possible busbar geometries, these spacings should not be adopted without actual testing by the user. Sharp electrodes and unusual geometries will require wider spacings.

*Note: Phase-to-phase distances are reduced more than phase-to-ground distances because it is assumed that each phase is insulated.*

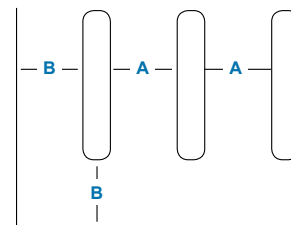

### Selection Information: dimensions in inches (millimeters)

System Voltage kV	BIL kV	Uninsulated Clearance (Indoor)		BBIT Clearance (Indoor)		BPTM, HVBT, and HVIS Clearance (Indoor)	
		A*	B**	A*	B**	A*	B**
15	95	7.5 (190)	5.0 (125)	2.2 (55)	2.6 (65)	3.4 (85)	4.2 (105)
25	125	10.5 (265)	7.5 (190)	2.8 (70)	4.0 (100)	4.5 (115)	6.0 (150)
35	150	12.5 (320)	9.5 (240)	5.6 (140)	7.5 (190)	6.5 (165)	8.0 (200)

\* Phase-to-phase  
\*\* Phase-to-ground

### Recommended Guide Specification

Please feel free to use the following in your design specification:

Insulation for energized bus components and connections shall consist of tubing, tape, and sheets that are factory-engineered to meet applicable switchgear performance requirements.

All insulation components shall be fabricated from flexible, crosslinked, heat-shrinkable polymeric materials formulated to provide high dielectric strength, adequate thermal endurance at bus operating temperatures, and tracking and erosion resistance.

The insulation materials shall contain no halogen compounds and be compatible with other commercial, factory-installed bus insulation materials.

Materials shall be installable at temperatures as low as -40°F. Adhesive coatings on tape and sheet products shall not adhere to metal surfaces, thus permitting easy re-entry to the connections.

The insulation supplier shall furnish technical data to document design and performance to these requirements and functional testing of the complete insulation system in accordance with ANSI/IEEE C37.20.



69437.....	21	602380.....	10, 11	1-275187-1.....	33, 34
69611.....	21	602502.....	14	1-275187-2.....	33
69612.....	21	602585.....	14	1-275187-2.....	33, 34
69684.....	23	602586.....	14	1-275187-3.....	33, 34
69816.....	26	1-1099898-0.....	5	1-275187-4.....	33, 34
69847.....	23	1-1099898-1.....	5	1-275187-5.....	33, 34
69947.....	23	1-1099898-2.....	5	1-275187-6.....	33, 34
306814.....	23	1-1099898-3.....	5	1-275187-7.....	33, 34
600403.....	10, 11	1-1099898-4.....	5	1-275187-8.....	33, 34
600411.....	10, 11	1-1099898-5.....	5	1-276337-0.....	33, 34
600446.....	10, 11	1-1099899-0.....	5	1-276337-1.....	33, 34
600447.....	10, 11	1-1099899-1.....	5	1-276337-2.....	33, 34
600448.....	10, 11	1-1099899-2.....	5	1-276337-3.....	33, 34
600455.....	10, 11	1-1099899-3.....	5	1-276337-4.....	33, 34
600456.....	10, 11	1-1099899-4.....	5	1-276337-7.....	33, 34
600458.....	10, 11	1-1099899-5.....	5	1-276337-8.....	33
600459.....	10, 11	1-1099899-6.....	5	1-276337-9.....	33, 34
600463.....	14	1-1099899-7.....	5	1-602031-0.....	10, 11
600465.....	10, 11	1-1099899-8.....	5	1-602031-2.....	10, 12
600466.....	10, 11	1-1099899-9.....	5	1-602031-3.....	10, 12, 15
600468.....	14	1-1099939-0.....	5	1-602031-4.....	10, 12
600469.....	14	1-1099939-1.....	5	1-602031-5.....	10, 12, 15
600474.....	14	1-1099939-2.....	5	1-602031-6.....	10, 12
602000.....	10, 11	1-1099939-3.....	5	1-602031-7.....	10, 12, 15
602001.....	10, 11	1-1099939-4.....	5	1-602031-8.....	10, 12
602002.....	10, 11	1-1099939-5.....	5	1-602031-9.....	10, 12
602003.....	10, 11	1-1443402-0.....	7	1-602121-0.....	10, 12
602004.....	10, 11	1-1443402-1.....	7	1-602121-1.....	10, 12
602006.....	10, 11	1-1443402-2.....	7	1-602121-2.....	10, 12
602007.....	10, 11	1-1443402-3.....	7	1-602121-3.....	10, 12
602013.....	10, 11	1-1443402-4.....	7	1-602121-4.....	10, 12
602014.....	10, 11	1-1443402-5.....	7	1-602180-0.....	10, 12
602047.....	14	1-1443402-6.....	7	1-602180-1.....	10, 12
602080.....	20	1-1443402-7.....	7	1-602180-2.....	10, 12
602089.....	19	1-1443403-0.....	7	1-602180-3.....	10, 12
602091.....	19	1-1443403-1.....	7	1-602180-4.....	10, 12
602093.....	19	1-1443403-2.....	7	1-602180-5.....	10, 12
602097.....	19	1-1443403-3.....	7	1-602180-6.....	10, 12
602099.....	19	1-1443403-4.....	7	1-602300-0.....	10, 12
602104.....	14	1-1443403-5.....	7	1-602300-1.....	10, 12
602107.....	20	1-1443403-6.....	7	1-602300-2.....	10, 12
602115.....	14	1-1443403-7.....	7	1-602300-3.....	10, 12
602121.....	10, 12	1-1579002-8.....	273	1-602300-4.....	10, 12
602136.....	14	1-1710802-0.....	24	1-602300-5.....	10, 12
602142.....	14	1-1710802-1.....	24	1-602300-6.....	10, 12
602143.....	14	1-1710802-2.....	24	1-602300-7.....	10, 12
602162.....	14	1-1710802-3.....	24	1-76337-8.....	34
602163.....	14	1-1710802-4.....	24	1-81723-0.....	33
602173.....	14	1-1710802-5.....	24	1-81723-1.....	33
602174.....	14	1-1710814-0.....	25	1-81723-2.....	33
602178.....	20	1-1710814-1.....	25	1-81723-3.....	33
602179.....	20	1-1710889-0.....	25	1-83592-0.....	28
602180.....	10, 12	1-1710889-1.....	25	1-83592-0.....	28, 30
602201.....	14	1-1710889-2.....	25	1-83592-1.....	28, 30
602237.....	14	1-1710889-3.....	25	1-83592-2.....	28, 30
602247.....	14	1-1710889-4.....	25	1-83592-3.....	28, 30
602248.....	14	1-1710889-5.....	25	1-83623-0.....	29, 30
602283.....	10, 11	1-1710889-6.....	25	1-83623-1.....	29, 30
602284.....	20	1-1710889-7.....	25	1-83623-2.....	29, 30
602285.....	19	1-1710889-8.....	25	1-83623-3.....	29, 30
602286.....	19	1-1710905-0.....	25	1-83623-4.....	29, 30
602287.....	19	1-275187-0.....	33	1-83623-5.....	29, 30
602300.....	10, 12	1-275187-0.....	34	1-83623-6.....	29, 30

## Index

1-83623-7	29, 30	1443403-3	7	1710889-7	25
1-83623-8	29, 30	1443403-4	7	1710889-8	25
1-83623-9	29, 30	1443403-5	7	1710889-9	25
1-83630-0	29, 30	1443403-6	7	1710905-1	25
1-83631-1	29, 30	1443403-7	7	1710905-2	25
1-83631-2	29, 30	1443403-8	7	1710905-3	25
1-83631-3	29, 30	1443403-9	7	1710905-5	25
1-83631-4	29, 30	1443413-2	22	1710905-6	25
1-83631-5	29, 30	1443442-1	22	1710905-7	25
1-83631-6	29, 30	1443448-1	22	1710905-8	25
1-83631-7	29, 30	1443470-1	22	1710905-9	25
1-83631-8	29, 30	1443514-1	22	2-1710802-0	24
1-83631-9	29, 30	1490489-1	273	2-1710802-1	24
1-83843-0	18	169415-1	273	2-1710802-2	24
1-83843-1	18	1710500-1	20	2-1710802-3	24
109423-1	13	1710501-1	20	2-1710802-4	24
109424-1	13	1710523-1	20	2-1710802-5	24
109433-1	13	1710705-1	24	2-1710802-6	24
109703-1	13	1710705-2	24	2-1710802-7	24
1099898-1	5	1710705-3	24	2-1710802-8	24
1099898-2	5	1710705-5	24	2-1710802-9	24
1099898-3	5	1710705-6	24	2-1710889-0	25
1099898-4	5	1710705-7	24	2-1710889-1	25
1099898-5	5	1710705-8	24	2-1710889-2	25
1099898-6	5	1710705-9	24	2-1710889-3	25
1099898-7	5	1710802-1	24	2-1710889-4	25
1099898-8	5	1710802-2	24	2-1710889-5	25
1099898-9	5	1710802-3	24	2-1710889-6	25
1099899-1	5	1710802-4	24	2-1710889-8	25
1099899-2	5	1710802-5	24	2-1710889-9	25
1099899-3	5	1710802-6	24	2-226337-1	33
1099899-4	5	1710802-7	24	2-275187-8	33, 34
1099899-5	5	1710802-8	24	2-276337-0	33, 34
1099899-6	5	1710802-9	24	2-276337-1	33, 34
1099899-7	5	1710813-1	25	2-276337-2	33, 34
1099899-8	5	1710813-2	25	2-276337-3	33, 34
1099899-9	5	1710813-3	25	2-276337-4	33, 34
1099939-1	5	1710813-4	25	2-276337-5	33, 34
1099939-2	5	1710813-5	25	2-276337-8	33, 34
1099939-3	5	1710813-6	25	2-276337-9	33, 34
1099939-4	5	1710813-7	25	2-602031-0	10, 12
1099939-5	5	1710813-8	25	2-602031-1	10, 12
1099939-6	5	1710814-1	25	2-602031-2	10, 12
1099939-7	5	1710814-2	25	2-83623-0	29, 30
1099939-8	5	1710814-3	25	2060-NPS	228
1099939-9	5	1710814-4	25	2060-VPS	228
1443208-1	13	1710814-5	25	2090-NPS	228
1443209-1	13	1710814-6	25	2182075-1	23
1443259-1	13	1710814-7	25	2182076-1	23
1443268-1	13	1710814-8	25	273337-6	33
1443312-1	14	1710814-9	25	275187-1	33, 34
1443316-2	13	1710837-1	23	275187-2	33, 34
1443402-1	7	1710837-2	23	275187-3	33, 34
1443402-2	7	1710837-3	23	275187-4	33, 34
1443402-3	7	1710839-1	23	275187-5	33, 34
1443402-4	7	1710839-2	23	275187-6	33, 34
1443402-5	7	1710839-3	23	275187-7	33, 34
1443402-6	7	1710889-1	25	275187-8	33, 34
1443402-7	7	1710889-2	25	275187-9	33, 34
1443402-8	7	1710889-3	25	275435-1	14
1443402-9	7	1710889-4	25	275436-1	14
1443403-1	7	1710889-5	25	276300-1	13
1443403-2	7	1710889-6	25	276337-1	33, 34

## Index

276337-2	33, 34	4-1710889-9	25	602121-4	10, 12
276337-3	33, 34	4-275187-0	33, 34	602121-5	10, 12, 15
276337-4	33, 34	4-276337-1	33, 34	602121-6	10, 12
276337-5	33, 34	4-276337-2	33, 34	602121-7	10, 12
276337-6	34	4-276337-3	33, 34	602121-8	10, 12
276337-7	33, 34	4-276337-4	33, 34	602121-9	10, 12
276337-8	33, 34	4-276337-5	33, 34	602180-1	10, 12
276337-9	33, 34	4-276337-6	33, 34	602180-2	10, 12
276478-1	14	4-276337-7	33, 34	602180-3	10, 12
276548-1	13	4-276337-8	33, 34	602180-4	10, 12
276762-1	35	4-276337-9	33, 34	602180-5	10, 12
276915-1	13	444031-1	41	602180-6	10, 12
277060-1	33, 34	444033-1	41	602180-7	10, 12
277060-2	33, 34	444385-1	41	602180-8	10, 12
277060-2	33	47667-8	21	602180-9	10, 12
277060-3	33, 34	5-1710889-0	25	602283-1	10, 11
277060-4	33, 34	5-1710889-1	25	602283-2	10, 11
3-1710802-0	24	5-1710889-2	25	602283-3	10, 11
3-1710889-0	25	5-1710889-3	25	602283-4	10, 11
3-1710889-1	25	5-1710889-4	25	602283-5	10, 11
3-1710889-2	25	5-1710889-5	25	602283-6	10, 11
3-1710889-3	25	5-1710889-6	25	602283-7	10, 11
3-1710889-4	25	5-1710889-7	25	602283-8	10, 11
3-1710889-5	25	5-1710889-8	25	602300-1	10, 12
3-1710889-6	25	5-1710889-9	25	602300-2	10, 12
3-1710889-7	25	5-276337-1	33, 34	602300-3	10, 12
3-1710889-8	25	5-276337-3	33, 34	602300-4	10, 12
3-1710889-9	25	5-276337-4	33, 34	602300-5	10, 12
3-275187-0	33, 34	5-276337-5	33, 34	602300-6	10, 12
3-275187-1	33, 34	5-276337-6	33, 34	602300-7	10, 12
3-275187-3	33, 34	5-276337-7	33, 34	602300-8	10, 12
3-275187-4	33, 34	5-276337-8	33, 34	602300-9	10, 12
3-275187-6	33, 34	5-276337-9	33, 34	602380-1	10, 11
3-275187-7	33, 34	5-304668-3	21	602380-2	10, 11
3-275187-9	33, 34	561118-1	22	602380-3	10, 11
3-276337-0	33, 34	569398-1	19	602380-4	10, 11
3-276337-1	33, 34	6-1710889-0	25	602380-5	10, 11
3-276337-2	33, 34	6-1710889-1	25	602380-6	10, 11
3-276337-3	33, 34	6-1710889-2	25	602380-7	10, 11
3-276337-4	33, 34	6-1710889-3	25	602880-0	13
3-276337-5	33, 34	6-1710889-4	25	602880-1	13
3-276337-6	33, 34	6-1710889-5	25	605742-1	272
3-276337-7	33, 34	6-1710889-6	25	605744-1	272
3-276337-9	33, 34	6-1710889-7	25	6060-VPS	230
306347-1	26	6-1710889-8	25	607453-2 1	273
306348-1	26	6-1710889-9	25	607501-1	23
306349-1	26	6-276337-0	33, 34	608338-1	23
306349-2	26	6-276337-2	33, 34	608877-1	23
306350-2	26	6-276337-4	33, 34	6090-VPS	230
308967-1	21	6-276337-5	33, 34	6090-VPS-UL	230
3090-NPS	229	602031-8	10, 11	688652-1	41
3090-VFS	229	602031-9	10, 11	688653-1	41
314196-1	21	602046-1	10, 11	688654-1	41
314199-1	23	602046-2	10, 11	688655-1	41
4-1710889-0	25	602046-3	10, 11	688656-1	41
4-1710889-1	25	602046-4	10, 11	688657-1	41
4-1710889-2	25	602046-5	10, 11	69338-1	22
4-1710889-3	25	602046-6	10, 11	69338-2	22
4-1710889-4	25	602046-7	10, 11	69338-4	22
4-1710889-5	25	602046-9	10, 11	69338-5	22
4-1710889-6	25	602121-1	10, 12	69610-2	22
4-1710889-7	25	602121-2	10, 12	69633-2	21
4-1710889-8	25	602121-3	10, 12	69685-1	23





CSJA-1523M2	149	CSJA-JCN/EG-1511M4	151	CSJG-3514M2	153
CSJA-1523M8	149	CSJA-JCN/EG-1511M5	151	CSJG-3514M8	153
CSJA-1524	149	CSJA-JCN/EG-1512	151	CSJG-3514M9	153
CSJA-1524M9	149	CSJA-JCN/EG-1512M1	151	CSJG-3515	153
CSJA-2822	149	CSJA-JCN/EG-1512M2	151	CSJG-3515M10	153
CSJA-2822M1	149	CSJA-JCN/EG-1512M6	151		
CSJA-2822M5	149	CSJA-JCN/EG-1512M7	151		
CSJA-2822M6	149	CSJA-JCN/EG-1513	151		
CSJA-2823	149	CSJA-JCN/EG-1513M2	151		
CSJA-2823M2	149	CSJA-JCN/EG-1513M8	151		
CSJA-2823M8	149	CSJA-JCN/EG-1514	151		
CSJA-2824	149	CSJA-JCN/EG-1514M9	151		
CSJA-2824M2	149	CSJA-JCN/EG-2812	151		
CSJA-2824M8	149	CSJA-JCN/EG-2812M1	151		
CSJA-2824M9	149	CSJA-JCN/EG-2812M5	151		
CSJA-3-1521-ARMR	155	CSJA-JCN/EG-2812M6	151		
CSJA-3-1521-TECK	156	CSJA-JCN/EG-2813	151		
CSJA-3-1521M1-ARMR	155	CSJA-JCN/EG-2813M2	151		
CSJA-3-1521M1-TECK	156	CSJA-JCN/EG-2813M8	151		
CSJA-3-1521M4-ARMR	155	CSJA-JCN/EG-2814	151		
CSJA-3-1521M4-TECK	156	CSJA-JCN/EG-2814M2	151		
CSJA-3-1521M5-ARMR	155	CSJA-JCN/EG-2814M8	151		
CSJA-3-1521M5-TECK	156	CSJA-JCN/EG-2814M9	151		
CSJA-3-1522-ARMR	155	CSJA-JCN/EG-3513	151		
CSJA-3-1522-TECK	156	CSJA-JCN/EG-3513M1	151		
CSJA-3-1522M1-ARMR	155	CSJA-JCN/EG-3513M5	151		
CSJA-3-1522M1-TECK	156	CSJA-JCN/EG-3514	151		
CSJA-3-1522M2-ARMR	155	CSJA-JCN/EG-3514M2	151		
CSJA-3-1522M2-TECK	156	CSJA-JCN/EG-3514M8	151		
CSJA-3-1522M6-ARMR	155	CSJA-JCN/EG-3514M9	151		
CSJA-3-1522M6-TECK	156	CSJA-JCN/EG-3515	151		
CSJA-3-1522M7-ARMR	155	CSJA-JCN/EG-3515M10	151		
CSJA-3-1522M7-TECK	156	CSJA-JCN/EG-3515M9	151		
CSJA-3-1523-ARMR	155	CSJG-1511	153		
CSJA-3-1523-TECK	156	CSJG-1511M1	153		
CSJA-3-1523M3-ARMR	155	CSJG-1511M4	153		
CSJA-3-1523M3-TECK	156	CSJG-1511M5	153		
CSJA-3-1523M8-ARMR	155	CSJG-1512	153		
CSJA-3-1523M8-TECK	156	CSJG-1512M1	153		
CSJA-3-2822-ARMR	155	CSJG-1512M2	153		
CSJA-3-2822M1-ARMR	155	CSJG-1512M6	153		
CSJA-3-2822M5-ARMR	155	CSJG-1512M7	153		
CSJA-3-2822M6-ARMR	155	CSJG-1513	153		
CSJA-3-2823-ARMR	155	CSJG-1513M2	153		
CSJA-3-2823M2-ARMR	155	CSJG-1513M8	153		
CSJA-3-2823M8-ARMR	155	CSJG-1514	153		
CSJA-3-3523-ARMR	155	CSJG-1514M9	153		
CSJA-3-3523M1-ARMR	155	CSJG-2812	153		
CSJA-3-3523M5-ARMR	155	CSJG-2812M1	153		
CSJA-3-3524-ARMR	155	CSJG-2812M5	153		
CSJA-3-3524M2-ARMR	155	CSJG-2812M6	153		
CSJA-3-3524M8-ARMR	155	CSJG-2813	153		
CSJA-3523	149	CSJG-2813M2	153		
CSJA-3523M1	149	CSJG-2813M8	153		
CSJA-3523M5	149	CSJG-2814	153		
CSJA-3524	149	CSJG-2814M2	153		
CSJA-3524M2	149	CSJG-2814M8	153		
CSJA-3524M8	149	CSJG-2814M9	153		
CSJA-3524M9	149	CSJG-3513	153		
CSJA-3525	149	CSJG-3513M1	153		
CSJA-3525M10	149	CSJG-3513M5	153		
CSJA-JCN/EG-1511	151	CSJG-3514	153		
CSJA-JCN/EG-1511M1	151				

## E

E4540-1250	268
E7512-0160	268
E7512-0220	268
E7512-0240	268
E7512-0260	268
EAKT 1521	265
EAKT 1523	265
EAKT 1524	265
EHVS-6920-W-CXXX	192
EHVS-6921-W-CXXX	192
EHVS-S	195
EHVS-T	194
EHVT-462-G	193
EHVT-462-SG	193
EHVT-463-G	193
EHVT-463-SG	193
EHVT-464-G	193
EHVT-464-SG	193
EHVT-465-G	193
EHVT-465-SG	193
EHVT-691-G	193
EHVT-691-SG	193
EHVT-692-G	193
EHVT-692-SG	193
EHVT-693-G	193
EHVT-693-SG	193
EHVT-BP	198
EHVT-BRKT-2.00IN	198
EHVT-BRKT-2.25IN	198
EHVT-BRKT-2.50IN	198
EHVT-BRKT-2.75IN	198
EHVT-BRKT-3.00IN	198
EHVT-BRKT-3.50IN	198
EHVT-BRKT-3.75IN	198
EHVT-BRKT-4.00IN	198
EHVT-BRKT-4.25IN	198
ELB-15/28-600	173
ELB-15/28-600-CP-AL	177
ELB-15/28-600-CP-CU	177
ELB-15/28-600-IC	176
ELB-15/28-600-J2-AL	179
ELB-15/28-600-J2-AL-ADJ	179
ELB-15/28-600-J2-AL-STD	179
ELB-15/28-600-J3-AL	179
ELB-15/28-600-J3-AL-ADJ	179
ELB-15/28-600-J3-AL-STD	179
ELB-15/28-600-J4-AL	179
ELB-15/28-600-J4-AL-ADJ	179
ELB-15/28-600-J4-AL-STD	179
ELB-15/28-600-SP	175
ELB-15/28-600-T1WAY	180
ELB-15/28-600-T2WAY	180
ELB-15/28-600-T3WAY	180
ELB-15/28-600-T4WAY	180
ELB-15/28-610-T1WAY	180

ELB-15/28-610-T2WAY .....	180	EPPA-054-X/Y-A .....	190	ETP-8080-0-38-20-B .....	217
ELB-15/28-610-T3WAY .....	180	EPPA-055-0/1 .....	197	EVHS-6922-W-CXXX .....	192
ELB-15/28-610-T4WAY .....	180	EPPA-055-0/3 .....	197	EVHS-6923-W-CXXX .....	192
ELB-15/28-900-J2-CU .....	179	EPPA-055-3/1 .....	197	EXRM-0607 .....	272
ELB-15/28-900-J2-CU-ADJ .....	179	EPPA-055-3/3 .....	197	EXRM-1004-US .....	272
ELB-15/28-900-J2-CU-STD .....	179	EPPA-055-6/1 .....	197		
ELB-15/28-900-J3-CU .....	179	EPPA-055-6/3 .....	197	<b>F</b>	
ELB-15/28-900-J3-CU-ADJ .....	179	EPPA-061-X/Y .....	190	FC-15M .....	234
ELB-15/28-900-J3-CU-STD .....	179	EPPA-063-X1/Y1-X2/Y2-L .....	190	FC-30M .....	234
ELB-15/28-900-J4-CU .....	179	EPPA-071-x/y .....	190	FC-60M .....	234
ELB-15/28-900-J4-CU-ADJ .....	179	EPPA-072-x/y .....	190	FCSM-120/40-1200-S .....	109, 212
ELB-15/28-900-J4-CU-STD .....	179	EPPA-076-X/Y .....	190	FCSM-120/40-1500/U .....	109, 212
ELB-35-600 .....	174	ESA-1 .....	183	FCSM-177/63 600-S .....	109, 212
ELB-35-600 ARSTR-27 .....	181	ESA-2 .....	183	FCSM-177/63-1200-S .....	109, 212
ELB-35-600 ARSTR-30 .....	181	ESC-1/A .....	213	FCSM-177/63-1500/U .....	109, 212
ELB-35-600 ARSTR-33 .....	181	ESC-2/A .....	213	FCSM-19/6-1200-S .....	109, 212
ELB-35-600 ARSTR-36 .....	181	ESC-3/A .....	213	FCSM-19/6-150-S .....	109, 212
ELB-35-600-CP-AL .....	177	ESC-4/A .....	213	FCSM-19/6-A/U .....	109, 212
ELB-35-600-CP-CU .....	177	ESC-5/A .....	213	FCSM-28/9-1200-S .....	109, 212
ELB-35-600-J2-AL .....	179	ESC-6/A .....	213	FCSM-28/9-225-S .....	109, 212
ELB-35-600-J2-AL-ADJ .....	179	ESC-7/A .....	213	FCSM-28/9-A/U .....	109, 212
ELB-35-600-J2-AL-STD .....	179	ETP-1818-0-19-20-B .....	217	FCSM-38/12-1200-S .....	109, 212
ELB-35-600-J3-AL .....	179	ETP-1818-1-19-20-B .....	217	FCSM-38/12-300-S .....	109, 212
ELB-35-600-J3-AL-ADJ .....	179	ETP-1818-3-19-20-B .....	217	FCSM-38/12-A/U .....	109, 212
ELB-35-600-J3-AL-STD .....	179	ETP-1818-4-19-20-B .....	217	FCSM-51/16-1200-S .....	109, 212
ELB-35-600-J4-AL .....	179	ETP-1818-5-19-20-B .....	217	FCSM-51/16-300-S .....	109, 212
ELB-35-600-J4-AL-ADJ .....	179	ETP-1818-6-19-20-B .....	217	FCSM-51/16-A/U .....	109, 212
ELB-35-600-J4-AL-STD .....	179	ETP-1818-7-19-20-B .....	217	FCSM-68/22-1200-S .....	109, 212
ELB-35-600-SP .....	175	ETP-1818-8-19-20-B .....	217	FCSM-68/22-A/U .....	109, 212
ELB-35-600-T1WAY .....	180	ETP-1818-9-19-20-B .....	217	FCSM-9/3-1200-S .....	109
ELB-35-600-T2WAY .....	180	ETP-2020-0-19-33-B .....	217	FCSM-9/3-1200-S #14 .....	212
ELB-35-600-T3WAY .....	180	ETP-2020-0-25-33-B .....	217	FCSM-9/3-A/U .....	109, 212
ELB-35-600-T4WAY .....	180	ETP-2020-0-38-33-B .....	217	FCSM-90/30-1200-S .....	109, 212
ELB-35-610-T1WAY .....	180	ETP-2020-0-51-33-B .....	217	FCSM-90/30-1500/U .....	109, 212
ELB-35-610-T2WAY .....	180	ETP-3030-0-19-20-A .....	217	FH-2618A-1 .....	270
ELB-35-610-T3WAY .....	180	ETP-3030-0-19-20-P-A .....	217	FH-2629-ELECTRODE .....	269
ELB-35-610-T4WAY .....	180	ETP-4040-0-19-20-B .....	217	FH-2629-Kit .....	270
ELB-35-900-J2-CU .....	179	ETP-4040-0-25-20-B .....	217	FH-2629-TORCH ASSY .....	269
ELB-35-900-J2-CU-ADJ .....	179	ETP-4040-0-38-20-A .....	217	FH-2640-PS-KIT .....	270
ELB-35-900-J2-CU-STD .....	179	ETP-4040-0-38-20-B .....	217	FH-2649-PS-KIT .....	270
ELB-35-900-J3-CU .....	179	ETP-4040-0-51-20-B .....	217	FH-3366-97-PS-HANDLE .....	269
ELB-35-900-J3-CU-ADJ .....	179	ETP-5050-0-19-20-B .....	217	FH-AD-3061-23-PS-REGULATOR .....	269
ELB-35-900-J3-CU-STD .....	179	ETP-7070-1-13-06-A .....	217	FH-AD-3341-91-PS-BURN1.5 .....	269
ELB-35-900-J4-CU .....	179	ETP-7070-1-19-20-P-A .....	217	FH-AD-3347-91-PS-BURN-1 .....	269
ELB-35-900-J4-CU-ADJ .....	179	ETP-7070-2-13-06-B .....	217	FH-AD-3348-91-PS-BURN-2 .....	269
ELB-35-900-J4-CU-STD .....	179	ETP-7070-3-13-06-B .....	217	FH-PS-2001 .....	271
ELB-600-CES-1 .....	182	ETP-7070-3-19-20-P-A .....	217	FSTW-2-1-6 .....	219
ELB-600-CES-1 .....	182	ETP-7070-4-13-06-B .....	217		
ELB-600-CES-2 .....	182	ETP-7070-4-19-20-P-A .....	217	<b>G</b>	
ELB-600-CES-2 .....	182	ETP-7070-5-13-06-A .....	217	GelCap 1 .....	115
ELB-600-CES-3 .....	182	ETP-7070-5-19-20-P-A .....	217	GelCap 2 .....	115
ELB-600-CES-3 .....	182	ETP-7070-6-13-06-B .....	217	GelCap 3 .....	115
EPPA-034-A .....	263	ETP-7070-6-19-20-P-A .....	217	GelCap 4 .....	115
EPPA-034-E .....	263	ETP-7070-7-13-06-A .....	217	GELCAP-8-GRD-1 .....	171
EPPA-034-F .....	263	ETP-7070-7-19-20-P-A .....	217	GELCAP-8-GRD-2 .....	171
EPPA-034-G .....	263	ETP-7070-8-13-06-B .....	217	GELCAP-8-NS-1V .....	171
EPPA-034-H .....	263	ETP-7070-8-19-20-P-A .....	217	GELCAP-8-NS-1VEX .....	171
EPPA-034-L .....	263	ETP-7070-9-13-06-B .....	217	GELCAP-8-NS-2V .....	171
EPPA-047-X/Y-L .....	190	ETP-7070-9-19-20-P-A .....	217	GELCAP-8-S-1V .....	171
EPPA-047-X1/Y1-X2/Y2-L .....	190	ETP-8080-0-19-20-A .....	217	GELCAP-8-S-1VEX .....	171
EPPA-050-X/Y .....	190	ETP-8080-0-19-20-P-A .....	217	GELCAP-8-S-2V .....	171
EPPA-053-X/Y .....	190	ETP-8080-0-25-20-A .....	217	GelCap-SL-2/0-3 Hole .....	119
EPPA-054-X/Y .....	190	ETP-8080-0-25-20-B .....	217		

GelCap-SL-2/0-3 Hole-B100 .....	119
GelWrap Pad 2x8 .....	222
GelWrap-18/4 -200 .....	104
GelWrap-18/4-100 .....	104
GelWrap-18/4-150 .....	104
GelWrap-18/4-150UL .....	104
GelWrap-18/4-200UL .....	104
GelWrap-18/4-250 .....	104
GelWrap-18/4-250UL .....	104
GelWrap-18/4-300 .....	104
GelWrap-18/4-300UL .....	104
GelWrap-18/4-350UL .....	104
GelWrap-18/4-400UL .....	104
GelWrap-18/4-450UL .....	104
GelWrap-18/4-500UL .....	104
GelWrap-18/4-550UL .....	104
GelWrap-18/4-600UL .....	104
GelWrap-33/10-150 .....	104
GelWrap-33/10-200 .....	104
GelWrap-33/10-250 .....	104
GelWrap-33/10-250-I350M4 .....	104
GelWrap-33/10-300 .....	104
GelWrap-33/10-350 .....	104
GelWrap-50/20-200 .....	104
GelWrap-50/20-250 .....	104
GelWrap-50/20-300 .....	104
GelWrap-50/20-350 .....	104
GelWrap-50/20-400 .....	104
GelWrap-ES-65/250150 .....	184
GelWrap-MS-GRD-1 .....	187
GelWrap-MS-GRD-1 .....	187
GelWrap-MS-GRD-2 .....	187
GelWrap-MS-GRD-2 .....	187
GelWrap-MS-GRD-3 .....	187
GelWrap-MS-GRD-3 .....	187
GelWrap-MS-GRD-CT-2 .....	187
GelWrap-UF-200 .....	104
GelWrap-UF-250UL .....	104
GHFC-1-90 .....	120
GHFC-2-90 .....	120
GHFC-2.5-90 .....	120
GHFC-3-90 .....	120
GHFC-MW .....	31
GILS-350 .....	105
GILS-4/0 .....	105
GMRS-100/40-1050 .....	202
GMRS-100/40-1200 .....	202
GMRS-100/40-750 .....	202
GMRS-100/40-850 .....	202
GMRS-75/25-1050 .....	202
GMRS-75/25-1200 .....	202
GMRS-75/25-650 .....	202
GMRS-75/25-750 .....	202
GMRS-75/25-850 .....	202
GPRT-350-3P .....	121
GPRT-350-4P .....	121
GPRT-350-5P .....	121
GPRT-350-6P .....	121
GPRT-350-8P .....	121
GPRT-350/4P-500/1P .....	121
GPRT-350/6P-500/2P .....	121
GTAP-1 .....	118
GTAP-2 .....	118

## H

HG-501A .....	271
HG-751A-C .....	271
HV-BRAID-4-1520 .....	262
HV-BRAID-6-1520 .....	262
HV-BRAID-8-1520 .....	262
HV-MSK-3/C-581 .....	147
HV-MSK-3/C-582 .....	147
HV-MSK-3/C-584 .....	147
HVBC-41 .....	241
HVBC-42 .....	241
HVBC-43 .....	241
HVBC-44 .....	241
HVBS-615/155-01-M-BP .....	259
HVBS-665/205-01-M-BP .....	259
HVBS-685/225-01-M-BP .....	259
HVBS-710/250-01-M-BP .....	259
HVBS-740/280-01-M-BP .....	259
HVBS-770/310-01-M-BP .....	259
HVBT-1-R-01 (B8) .....	221
HVBT-1-R-01 (B8) .....	238
HVBT-2-R-01 (B4) .....	238
HVBT-2-R-01 (B4) .....	221
HVBT-4-R-01 (B2) .....	238
HVBT-4-R-01 (B2) .....	221
HVCE 100/80-01 (B6) .....	257
HVCE 120/100-01 (B6) .....	257
HVCE 140/120-01 (B6) .....	257
HVCE 160/140-01 (B6) .....	257
HVCE 183/161-01 (B6) .....	257
HVCE 205/184-01 (B6) .....	257
HVCE 226/206-11 (B6) .....	257
HVCE 247/227-11 (B6) .....	257
HVCE 268/248-11 (B6) .....	257
HVCE 289/269-11 (B6) .....	257
HVCE 310/290-11 (B6) .....	257
HVCE 331/311-11 (B6) .....	257
HVCE 352/332-11 (B6) .....	257
HVCE 373/353-11 (B6) .....	257
HVCE 394/374-11 (B6) .....	257
HVCE-WA-175-02-FT (B6) .....	258
HVCE-WA-206-01 (B6) .....	258
HVCE-WA-216-01 (B6) .....	258
HVCE-WA-221-01 (B6) .....	258
HVCE-WA-226-01 (B6) .....	258
HVCE-WA-227-01 (B6) .....	258
HVCE-WA-234-01 (B6) .....	258
HVCE-WA-244-01-FT (B6) .....	258
HVCE-WA-248-01 (B6) .....	258
HVCE-WA-251-01 (B6) .....	258
HVCE-WA-255-01 (B6) .....	258
HVCE-WA-267-01 (B6) .....	258
HVCE-WA-271-01 (B6) .....	258
HVCE-WA-280-01 (B6) .....	258
HVCE-WA-281-01 (B6) .....	258
HVCE-WA-287-01 (B6) .....	258
HVCE-WA-292-01 (B6) .....	258
HVCE-WA-303-01 (B6) .....	258
HVCE-WA-323-01 (B6) .....	258
HVCE-WA-326-01 (B6) .....	258
HVCE-WA-330-01 (B6) .....	258
HVCE-WA-336-01 (B6) .....	258
HVCE-WA-341-01 (B6) .....	258
HVCE-WA-348-01 (B6) .....	258
HVCE-WA-349-01 (B6) .....	258
HVCE-WA-356-01 (B6) .....	258
HVCE-WA-359-01 (B6) .....	258
HVCE-WA-364-01 (B6) .....	258
HVCE-WA-367-01 (B6) .....	258
HVCE-WA-372-01 (B6) .....	258
HVCE-WA-373-01 (B6) .....	258
HVCE-WA-377-01 (B6) .....	258
HVCE-WA-381-01 (B6) .....	258
HVCE-WA-392-01 (B6) .....	258
HVCE-WA-393-01 (B6) .....	258
HVCE-WA-406-01 (B6) .....	258
HVCE-WA-407-01 (B6) .....	258
HVCE-WA-413-01 (B6) .....	258
HVCE-WA-421-01 (B6) .....	258
HVCE-WA-426-01 (B6) .....	258
HVCE-WA-429-01 (B6) .....	258
HVCE-WA-440-01 (B6) .....	258
HVCE-WA-442-01 (B6) .....	258
HVCE-WA-452-01 (B6) .....	258
HVCE-WA-457-01 (B6) .....	258
HVCE-WA-463-01 (B6) .....	258
HVCE-WA-482-01 (B6) .....	258
HVCE-WA-488-01 (B6) .....	258
HVCE-WA-490-01 (B6) .....	258
HVCE-WA-501-01 (B6) .....	258
HVCE-WA-528-01 (B6) .....	258
HVCE-WA-551-01 (B6) .....	258
HVCE-WA-584-01 (B6) .....	258
HVCE-WA-611-01 (B6) .....	258
HVE-1591 .....	188
HVE-1592 .....	188
HVE-1593 .....	188
HVE-1594 .....	188
HVES-1521D .....	146
HVES-1522D .....	146
HVES-1523D .....	146
HVES-1524D .....	146
HVES-2521D .....	146
HVES-2522D .....	146
HVES-2523D .....	146
HVES-3-1591 .....	146
HVES-3-1592 .....	146
HVES-3-1593 .....	146
HVES-3-1594 .....	146
HVES-3-2591E .....	146
HVES-3-2592E .....	146
HVES-3-2593E .....	146
HVIA-CABLE-HEATING-BLANKET .....	199
HVIA-SLIDE-RAIL-1580 .....	199
HVIA-Stripper 35/90-US .....	198
HVIA-Stripper 75/150-US .....	198
HVIS-05-(B3) NS .....	240
HVIS-10-(B1) NS .....	240
HVIS-Angle (B12) .....	240
HVIS-Clamp (B25) .....	240
HVIS-Flat (B12) .....	240
HVS-1521S .....	130, 137, 138
HVS-1521S-W .....	130
HVS-1522S .....	130, 137, 138
HVS-1522S-W .....	130
HVS-1523S .....	130, 137, 138



HVS-1523S-W	130	HVS-3583D	139	HVS-S-1512S-J-M5	125
HVS-1524S	130, 137, 138	HVS-3584D	139	HVS-S-1513S-J-M6	125
HVS-1524S-W	130	HVS-501	124, 137, 138	HVS-S-1514S-J-M8	125
HVS-1525S	130	HVS-502	124, 137, 138	HVS-S-1514S-J-M9	125
HVS-1525S-W	130	HVS-503	124, 137, 138	HVS-S-1522S-M4	129
HVS-1581D	139	HVS-821S	130, 137, 138	HVS-S-1522S-M5	129
HVS-1582D	139	HVS-822S	130, 137, 138	HVS-S-1523S-M6	129
HVS-1583D	139	HVS-823S	130, 137, 138	HVS-S-1524S-M8	129
HVS-1584D	139	HVS-824S	130, 137, 138	HVS-S-1524S-M9	129
HVS-2511E-J	126	HVS-825S	130, 137, 138	HVS-S-1532S-M4	131
HVS-2512E-J	126	HVS-C-1511S-J	125	HVS-S-1532S-M5	131
HVS-2513E-J	126	HVS-C-1512S-J	125	HVS-S-1533S-M6	131
HVS-2521S	130, 137, 138	HVS-C-1512S-J-M1	125	HVS-S-1534S-M8	131
HVS-2522S	130, 137, 138	HVS-C-1512S-RJ-M4	127	HVS-S-1534S-M9	131
HVS-2523S	130, 137, 138	HVS-C-1512S-RJ-M5	127	HVS-SHIM-1	134
HVS-2531-LC	132	HVS-C-1513S-J	125	HVS-SHIM-2	134
HVS-2532-LC	132	HVS-C-1513S-J-M2	125	HVS-SHIM-3	134
HVS-2533-LC	132	HVS-C-1513S-RJ-M7	127	HVS-SHIM-4	134
HVS-2582E	139	HVS-C-1514S-J	125	HVS-SHIM-5	134
HVS-2583E	139	HVS-C-1514S-RJ-M8	127	HVS-SHIM-6	134
HVS-2584E	139	HVS-C-1514S-RJ-M9	127	HVS-T-1581E-S	141
HVS-3-1521S	135	HVS-C-1521S	128	HVS-T-1581S	141
HVS-3-1522S	135	HVS-C-1522S	128	HVS-T-1582E-S	141
HVS-3-1523S	135	HVS-C-1522S-M1	128	HVS-T-1582S	141
HVS-3-1524S	135	HVS-C-1522S-RJ-M4	127	HVS-T-1583E-S	141
HVS-3-1581S	143	HVS-C-1522S-RJ-M5	127	HVS-T-1583S	141
HVS-3-1582S	143	HVS-C-1523S	128	HVS-T-1584S	141
HVS-3-1583S	143	HVS-C-1523S-M2	128	HVS-T-1591S	142
HVS-3-1584S	143	HVS-C-1523S-RJ-M7	127	HVS-T-1592S	142
HVS-3-1591	140	HVS-C-1524S	128	HVS-T-1593S	142
HVS-3-1591S	140	HVS-C-1524S-RJ-M8	127	HVS-T-2582E	141
HVS-3-1592	140	HVS-C-1524S-RJ-M9	127	HVS-T-2583E	141
HVS-3-1592S	140	HVS-C-1531S	131	HVS-T-2584E	141
HVS-3-1593	140	HVS-C-1532S	131	HVS-T-3582S	141
HVS-3-1593S	140	HVS-C-1532S-M1	131	HVS-T-3583S	141
HVS-3-1594	140	HVS-C-1533S	131	HVSA-1	138
HVS-3-2521S	135	HVS-C-1533S-M2	131	HVSA-2	138
HVS-3-2522S	135	HVS-C-1534S	131	HVSA-3	138
HVS-3-2523S	135	HVS-C-2511S-RJ-M4	127	HVSA-3-1521S	136
HVS-3-2591E	140	HVS-C-2512S-RJ-M5	127	HVSA-3-1521S-TECK	133
HVS-3-2592E	140	HVS-C-2513S-RJ-M8	127	HVSA-3-1522S	136
HVS-3-501	124	HVS-C-2514S-RJ-M9	127	HVSA-3-1522S-TECK	133
HVS-3-502	124	HVS-C-2521S-RJ-M4	127	HVSA-3-1523S	136
HVS-3-503	124	HVS-C-2522S-RJ-M5	127	HVSA-3-1523S-TECK	133
HVS-3-821S	135	HVS-C-2523S-RJ-M8	127	HVSA-3-1524S	136
HVS-3-822S	135	HVS-C-2524S-RJ-M9	127	HVSA-3-1524S-TECK	133
HVS-3-823S	135	HVS-EG-1	129	HVSA-3-1581S	143
HVS-3-824S	135	HVS-EG-2	129	HVSA-3-1582S	143
HVS-3-825S	135	HVS-EG-3	129	HVSA-3-1583S	143
HVS-3/C-1	137	HVS-EG-3-1	129	HVSA-3-1584S	143
HVS-3/C-2	137	HVS-EG-3-2	129	HVSA-3-501	124
HVS-3/C-3	137	HVS-EG-3-3	129	HVSA-3-502	124
HVS-3/C-4	137	HVS-GC-0.5	263	HVSA-3-503	124
HVS-3511S-J	126	HVS-GC-1.0	263	HVSA-3-821S	136
HVS-3512S-J	126	HVS-GC-1.5	263	HVSA-3-822S	136
HVS-3513S-J	126	HVS-LR-160/42-1200	204, 264	HVSA-3-823S	136
HVS-3521S	130, 137, 138	HVS-LR-160/42-600	204, 264	HVSA-3-824S	136
HVS-3522S	130, 137, 138	HVS-LR-200/50-1200	204, 264	HVSA-3-825S	136
HVS-3523S	130, 137, 138	HVS-LR-200/50-600	204, 264	HVSA-4	138
HVS-3531-LC	132	HVS-LR-75/15-1200	204, 264	HVSH-1522-MOD	145
HVS-3532-LC	132	HVS-LR-75/15-600	204, 264	HVSH-1523-MOD	145
HVS-3533-LC	132	HVS-MESH-2-5000	262	HVSH-1582D-MOD	145
HVS-3582D	139	HVS-S-1512S-J-M4	125	HVSH-1583D-MOD	145



IDP-SB200225WE1-T200	95
IDP-SB200225WE2.5	95
IDP-SB200375WE1-T200	95
IDP-SB200375WE2.5	95
IDP-SB200743WE0.5-T200	95
IDP-SB200743WE1	95
IDP-SST141-316	94
IDP-SST71-316	94
IDP-T200-RIBBON-1966	101
IDP-T200-SPINDLE	102
IDP-T208M-C-PRINTER	101
IDP-T208M-PRINTER	101
IDP-T208M-Ribbon	101
IDP-T312M-PRINTER	101
IDP-T312S-C-PRINTER	101
IDP-TE3112-PRINTER	100, 101
IDP-TMS-RJS-RIBN-4RPSCE	101
IDP-TTPA100WE-10	97
IDP-TTPA100YW-10	97
IDP-TTPA200MP-10	97
IDP-TTPA200WE-10	97
IDP-TTPA300MP-10	97
IDP-TTPA300WE-10	97
IDP-TTPA400MP-10	97
IDP-TTPA400WE-10	97
IDP-WINTOTAL-SWARE	101
IDP-WINTOTAL-SWARE-DGLUS	101
IDP-WP-040040-25-9	96
IDP-WP-064064-25-9	96
IDP-WP-080080-10-9	96
IDP-WP-101165-0.85-9	96
IDP-WP-101635-2.5-9	96
IDP-WP-114040-25-9	96
IDP-WP-127111-10-9	96
IDP-WP-165051-25-9	96
IDP-WP-165102-10-9	96
IDP-WP-178095-10-9	96
IDP-WP-191064-10-9	96
IDP-WP-203127-10-9	96
IDP-WP-229364-10-9	96
IDP-WP-254097-10-9	96
IDP-WP-254127-10-9	96
IDP-WP-254254-10-9	96
IDP-WP-318064-10-9	96
IDP-WP-381020-10-9	96
IDP-WP-381064-10-9	96
IDP-WP-381190-5-9	96
IDP-WP-508064-10-9	96
IDP-WP-508127-10-9	96
IDP-WP-508254-5-9	96
IDP-WP-508318-2.5-9	96
IDP-WP-523841-1.5-9	96
IDP-WP-700254-5-9	96
IDP-WP-762381-2.5-9	96
IDP-WP-762508-2.5-9	96
IDP-WP-950950-10-9	96
IT 1000-002	273
IT-1000-006	274
IT-1000-019	274
IT-1000-023-US	272
IT-1000-030-2	274
IT-1000-030-2-BLADE	274

**J**

JGK-MS-1	186, 262
JGK-MS-2	186, 262
JGK-MS-3	186, 262
JGK-MS-HC-2	186
JGK-MS-HC-3	186

**K**

KMS-K-INT	273
-----------	-----

**L**

LC-120	226
LC-208-277	226
LHM 1R 30/45	274
Lifting Device	198
LM-1-1/4-SL	99
LM-1-SL	99
LM-1-TAPE-BK	99
LM-1-TAPE-CR	99
LM-1-TAPE-WE	99
LM-1-TAPE-YW	99
LM-1-VINYL-CR	99
LM-1-VINYL-RD	99
LM-1-VINYL-SR	99
LM-1-VINYL-WE	99
LM-1-VINYL-YW	99
LM-1/2-SL	99
LM-1/2-TAPE-BK	99
LM-1/2-TAPE-CR	99
LM-1/2-TAPE-WE	99
LM-1/2-TAPE-YW	99
LM-1/2-TUBE-WE	99
LM-1/2-TUBE-YW	99
LM-1/2-VINYL-CR	99
LM-1/2-VINYL-RD	99
LM-1/2-VINYL-WE	99
LM-1/2-VINYL-YW	99
LM-1/4-TUBE-WE	99
LM-1/4-TUBE-YW	99
LM-1/8-TUBE-WE	99
LM-1/8-TUBE-YW	99
LM-1000	227
LM-2-1/2-SL	99
LM-3/16-TUBE-WE	99
LM-3/16-TUBE-YW	99
LM-3/4-SL	99
LM-4-SL	99
LM-CASE	99
LM2020PLUS-2500MAH-NICAD	99
LM2020PLUS-PRINTER-KIT	99
LV-MSK-045	114
LV-MSK-046	114
LV-MSK-047	114
LV-MSK-058	114
LVBT-1-R	220
LVBT-2-R	220
LVBT-4-R	220
LVIT-150/50-A/U	213
LVIT-30/10-A/U	213
LVIT-75/25-A/U	162
LVIT-75/25-A/U	162
LVIT-75/25-A/U	213

LVSA-3-1	113
LVSA-3-2	113
LVSA-3-3	113
LVSA-3-4	113

**M**

M-120	227
M-208-277	227
M-347	227
M-480	227
M-PV	227
MBSM-125/30-1200	203
MBSM-160/42-1200	203
MBSM-200/50-1200	203
MBSM-43/8-1200	203
MBSM-75/15-1200	203
MC-10	235
MC-10ANSI	235
MCK-1L	117
MCK-1V	117
MCK-2L	117
MCK-2V	117
MCK-3V	117
MCK-4V	117
MCK-5-1L	172
MCK-5-1V	172
MCK-5-2L	172
MCK-5-2V	172
MCK-5-3V	172
MH-120	227
MH-208-277	227
MH-PV	227
MOD-3A-HVT	161
MOD-3B-HVT	161
MOD-3D-TFT	170
MOD-3X-HVT	161
MOD-3Y-HVT	161
MOD-3Z-TFT	170
MOD-S1-314-Skirts	266
MOD-S2-325-Skirts	266
MOD-S3-336-Skirts	266
MOD-S4-346-Skirts	266
MOD-S5-357-Skirts	266
MRS-12-10	112, 206
MRS-12-24	112, 206
MRS-34-24	112, 206
MRS-34-30	112, 206
MRS-56-30	112, 206
MVCC-10/40 (B100)	251
MVCC-19/0.750 (B50)	251
MVCC-25/1.0 (B25)	251
MVCC-45/1.75 x 4 (B24)	251
MVCC-G-10/40 (B100)	251
MVCC-G-19/0.750 (B50)	251
MVCC-G-25/1.0 (B25)	251
MVCC-G-45/1.75 x4 (B24)	251
MVFT-G-2-12(B4)	219, 251
MVLC 38-A/241-1830 (B18)	255
MVLC-14-1830/241 (B18)	255
MVLC-14-1830/U (B18)	255
MVLC-14-A/241-C-100	255
MVLC-14-A/U-C-100	255
MVLC-14-TOOL-100	255

MVLC-18-1830/U (B18) .....	255
MVLC-18-A/241-1830 (B18) .....	255
MVLC-18-A/241-C-75 .....	255
MVLC-18-A/U-C-75 .....	255
MVLC-18-TOOL-03-2006 .....	255
MVLC-38-A/241-C-50 .....	255
MVLC-38-A/U-1830 (B18) .....	255
MVLC-38-A/U-C-50 .....	255
MVLC-38-TOOL-03-2006 .....	255
MVLC-HAND-TOOL-02 .....	255
MVLC-HAND-TOOL-14 .....	255
MVLC-Hydraul-Drill .....	255
MWTM-10/3-1200-S .....	106, 209
MWTM-10/3-A/U .....	106, 209
MWTM-115/34-1200-S .....	106, 209
MWTM-115/34-1500/U .....	106, 209
MWTM-140/42-1200-S .....	106, 209
MWTM-140/42-1500/U .....	106, 209
MWTM-16/5-1200-S .....	106, 209
MWTM-16/5-1200/U .....	162
MWTM-16/5-1500/U .....	162
MWTM-16/5-A/U .....	162, 209
MWTM-25/8-1200-S .....	106, 209
MWTM-25/8-A/U .....	106, 209
MWTM-35/12-1200-S .....	106, 209
MWTM-35/12-1200/U .....	162
MWTM-35/12-A/U .....	106, 162, 209
MWTM-50/16-1200-S .....	106, 209
MWTM-50/16-A/U .....	106, 209
MWTM-85/25-1200-S .....	106, 209
MWTM-85/25-1500/U .....	106, 162, 209

**N**

NS-10 .....	235
NS-10ANSI .....	235

**O**

OHVT .....	196
OHVT-D .....	196

**P**

P63 .....	263
PC-101R .....	234
PC-103R .....	234
PC-104R .....	234
PHVS/PHVT .....	197
PT-15 .....	224
PT-168 .....	224
PT-20 .....	224
PT-347 .....	224

**R**

RBDP-BLA-10D104U .....	268
RBDP-BLA-12D148U .....	268
RBDP-BLA-15D183U .....	268
RBDP-BLA-20D236U .....	268
RBDP-BLA-30D346U .....	268
RBDP-BLA-40D402U .....	268
RBDP-BLA-50D535U .....	268

RBDP-BLA-60D637U .....	268
RBDP-BLA-80D816U .....	268
RDSS-100 .....	267
RDSS-125 .....	267
RDSS-150 .....	267
RDSS-45 .....	267
RDSS-60 .....	267
RDSS-75 .....	267
RDSS-AD-210 .....	268
RDSS-AT/AP-150 .....	268
RDSS-CLIP-100 .....	267
RDSS-CLIP-125 .....	267
RDSS-CLIP-150 .....	267
RDSS-CLIP-45 .....	267
RDSS-CLIP-75 .....	267
RDSS-IG-SR-AS .....	268
RDSS-IT-16 .....	268
RNF-100-1 1/2-25-(color) .....	208
RNF-100-1-25-(color) .....	208
RNF-100-1/16-25-(color) .....	208
RNF-100-1/2-150-(color) .....	208
RNF-100-1/2-25-(color) .....	208
RNF-100-1/4-25-(color) .....	208
RNF-100-1/4-250-(color) .....	208
RNF-100-1/8-25-(color) .....	208
RNF-100-1/8-500-(color) .....	208
RNF-100-2-25-(color) .....	208
RNF-100-3/16-25-(color) .....	208
RNF-100-3/32-25-(color) .....	208
RNF-100-3/4-25-(color) .....	208
RNF-100-3/8-200-(color) .....	208
RNF-100-3/8-25-(color) .....	208
RRBB-2440/1220-6.2-BP .....	241
RRBB-6-1.25Mx1.25M-(B3) .....	241
RRGS-35/470-FT (B12) .....	259
RRGS-35/470-M (B12) .....	260
RRGS-35/600-FT (B12) .....	260
RRGS-35/600-M(B12) .....	260
RVC-1V .....	116
RVC-2V .....	116
RVC-3V .....	116
RVC-4V .....	116
RVS-11 .....	105
RVS-12 .....	105
RVS-13 .....	105
RVS-13-SK .....	185
RVS-14 .....	105
RVS-14-SK .....	185
RVS-15 -SK .....	185

**S**

S-1052-3-3000 .....	222
S-1171-4-300 .....	222
S-1174-2-300 .....	222
S-1174-4-460 .....	222
S-1189-3-600 .....	222
S-1251-25-300-4 .....	222
S-1251-50-300-1 .....	222
S-1278-3 x 61 x 7620 .....	222, 268
S1085-3-380 .....	162
SC-10A .....	235
SC-10ANSI .....	235

Screw Clamps .....	199
ShrinkMark-10-2-9 .....	92
ShrinkMark-10-2-S1-9 .....	92
ShrinkMark-1000-2-9 .....	92
ShrinkMark-1000-2-S1-9 .....	92
ShrinkMark-12-2-9 .....	92
ShrinkMark-12-2-S1-9 .....	92
ShrinkMark-18-2-9 .....	92
ShrinkMark-18-2-S1-9 .....	92
ShrinkMark-2-2-9 .....	92
ShrinkMark-2-2-S1-9 .....	92
ShrinkMark-250-2-9 .....	92
ShrinkMark-250-2-S1-9 .....	92
SIMIL 0711744-1 .....	274
SIML 0-0711748-1 .....	274
SIML 0-0711749-1 .....	274
SIML 0-711745-1 .....	274
SIML 0-711746-1 .....	274
SIML-1-708052-1 .....	8
SIML-1727742-1 .....	8
SL-250-120V-F-01 (B1) .....	122
SL-250-120V-NF-FT (B1) .....	122
SL-350-120V-F-01 (B1) .....	122
SL-350-120V-NF-FT (B1) .....	122
SL-4/0-120V-F-01 (B1) .....	122
SL-4/0-120V-NF-FT (B1) .....	122
SL-500-120V-F-01 (B1) .....	122
SL-500-120V-NF-FT (B1) .....	122
SL-750-120V-F-01 (B1) .....	122
SL-750-120V-NF-FT (B1) .....	122
SPI-0.8P-1050 .....	200
SPI-0.95P-900 .....	200
SPI-0.9P-1470 .....	200
SPI-0.9P-1550 .....	200
SPI-1.17P-1470 .....	200
SPI-1.25P-1050 .....	200
SPI-1.2P-2050 .....	200
SPI-1.2P-2250 .....	200
SPI-1.2P-750 .....	200
SPI-1.45P-1300 .....	200
SPI-1.45P-900 .....	200
SPI-1.4P-1800 .....	200
SPI-1.4P-2400 .....	200
SPI-1.4P-2550 .....	200
SPI-1.4P-650 .....	200
SPI-1.6P-2050 .....	200
SPI-1.6P-2250 .....	200
SPI-1.75P-1470 .....	200
SPI-1.7P-1550 .....	200
SPI-1.7P-550 .....	200
SPI-1.85P-750 .....	200
SPI-1P-1300 .....	200
SPI-1P-2400 .....	200
SPI-1P-2550 .....	200
SPI-2.2P-2050 .....	200
SPI-2.2P-2250 .....	200
SPI-2.2P-650 .....	200
SPI-2.2P-900 .....	200
SPI-2.3P-1050 .....	200
SPI-2.4P-1550 .....	200
SPI-2.6P-550 .....	200
SPI-2.8P-1800 .....	200
SPI-2P-1300 .....	200

SPI-2P-1800	200
SPI-2P-2400	200
SPI-2P-2550	200
SPI-3.7P-750	200
SPI-3P-900	200
SPI-4.4P-650	200
SPI-5.2P-550	200
SPT-15	224
SPT-168	224
SPT-19	224
SPT-347	224
SST-FAA	233
SST-PV	233
SST-PV-IES	233
SST-PV-IES-UL	233
STD03W-x	94
STD06W-x	94
STD09W-x	94
STD12W-x	94
STD15MO	94
STD15W-x	94
STD17MO	94
STD17W-x	94
STD21MO	94
STD21W-x	94
STD24MO	94
STD24W-x	94

## T

T208M Printer	100
T312M Printer	100
TC-101	234
TC-101R	234
TC-103	234
TC-103R	234
TC-104	234
TC-104R	234
TEC K-11	133
TECK-41	133
TECK-10	133
TECK-12	133
TECK-13	133
TECK-14	133
TECK-42	133
TECK-43	133
TECK-44	133
TECK-531	133
TECK-532	133
TFT-150R-G	167, 170
TFT-151E	169
TFT-151E / SG/SLC	168
TFT-151E-G	169
TFT-151E-SG	169
TFT-151E-SLC	169
TFT-151R-G	167, 170
TFT-151R-SG	167, 170
TFT-152E	169
TFT-152E/SG/SLC	168
TFT-152E-G	169
TFT-152E-SLC	169
TFT-152R-G	167, 170
TFT-152R-SG	167, 170

TFT-153E	169
TFT-153E/SG/SLC	168
TFT-153E-G	169
TFT-153E-SG	169
TFT-153E-SLC	169
TFT-153R-G	167, 170
TFT-153R-SG	167, 170
TFT-154E	169
TFT-154E/SG/SLC	168
TFT-154E-SG	169
TFT-154E-SLC	169
TFT-154R-SG	167, 170
TFT-251E	169
TFT-251E/SG/SLC	168
TFT-251E-SG	169
TFT-251E-SLC	169
TFT-251R-SG	167, 170
TFT-252E	169
TFT-252E/SG/SLC	168
TFT-252E-SG	169
TFT-252E-SLC	169
TFT-252R-SG	167, 170
TFT-253E	169
TFT-253E/SG/SLC	168
TFT-253E-SG	169
TFT-253E-SLC	169
TFT-253R-SG	167, 170
TFT-254E	169
TFT-254E/SG/SLC	168
TFT-254E-SG	169
TFT-254E-SLC	169
TFT-254R-SG	167, 170
TFT-352E	169
TFT-352E/SG/SLC	168
TFT-352E-SG	169
TFT-352E-SLC	169
TFT-352R-SG	167, 170
TFT-353E	169
TFT-353E/SG/SLC	168
TFT-353E-SG	169
TFT-353E-SLC	169
TFT-353E-T5	168
TFT-353R-SG	167, 170
TFT-354E	169
TFT-354E/SG/SLC	168
TFT-354E-SG	169
TFT-354E-SLC	169
TFT-354E-T8	168
TFT-354E-T9	168
TFT-354R-SG	167, 170
TFT-50R	167, 170
TFT-51R	167, 170
TFT-52R	167, 170
TFT-53R	167, 170
TFT-P-80R	167
TG-12 Reflector	271
TG-13 Reflector	271
TG-23 Reflector	271
TG-24 Reflector	271
TL-115	225
TL-1168	225
Tool Box	199

## U

US-30	236
-------	-----

## W

WCSM-105/30-1200-S	107
WCSM-105/30-1200-S3	210
WCSM-105/30-300-S	107
WCSM-105/30-300-S3	210
WCSM-13/4-1200-S	107, 210
WCSM-13/4-150-S	107, 210
WCSM-13/4-A/U	108, 211
WCSM-130/36-1200-S	107
WCSM-130/36-1200-S3	210
WCSM-130/36-1500/U	108, 211
WCSM-130/36-300-S	107
WCSM-130/36-300-S3	210
WCSM-130/36-450-S	107
WCSM-130/36-450-S3	210
WCSM-20/6-1200-S	107, 210
WCSM-20/6-150-S	107, 162, 210
WCSM-20/6-225-S	107, 210
WCSM-20/6-300-S	107, 210
WCSM-20/6-A/U	108, 211
WCSM-33/8-1200-S	107, 210
WCSM-33/8-150-S	107, 210
WCSM-33/8-225-S	107, 210
WCSM-33/8-300-S	107, 210
WCSM-33/8-A/U	108, 211
WCSM-43/12-1200-S	107, 210
WCSM-43/12-150-S	107, 210
WCSM-43/12-225-S	107, 210
WCSM-43/12-300-S	107, 210
WCSM-43/12-A/U	108, 211
WCSM-51/16-100-S	107
WCSM-51/16-100-S3	210
WCSM-51/16-1200-S	107, 210
WCSM-51/16-225-S	107, 210
WCSM-51/16-300-S	107, 210
WCSM-51/16-A/U	108, 211
WCSM-70/21-1200-S	107, 162, 210
WCSM-70/21-150-S	162
WCSM-70/21-300-S	107, 210
WCSM-70/21-450-S	107, 210
WCSM-70/21-600-S	107, 210
WCSM-70/21-A/U	108, 211
WCSM-9/3-1200-S	107, 210
WCSM-9/3-150-S	107
WCSM-9/3-300-S	107, 210
WCSM-9/3-A/U	108, 211
WCSM-90/30-1500/U	108, 211

