

# SMD 2.45GHz Dielectric Band Pass Filter

ADFC18-2450.00-A-T

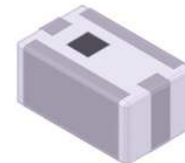

**RoHS**  
Compliant



1.6 x 0.8 x 0.60 mm

## FEATURES:

- Small and low profile enables high density mounting
- Low insertion loss & attenuation
- Internally shielded for enhanced performance
- Excellent solderability

## APPLICATIONS:

- Mobile communication system
- Bluetooth, Wireless LAN, WIFI, GPS, etc.

## STANDARD SPECIFICATIONS:

Parameters	Minimum	Typical	Maximum	Units	Notes
Center Frequency ( $f_0$ )		2450.00		MHz	
Passband width	2400.00		2500.00	MHz	
Insertion Loss (2400 ~ 2500MHz)			1.6	dB	@+25°C
			1.8	dB	@ -40 ~ +85°C
Amplitude Ripple (2400 ~ 2500MHz)			0.5	dB	
V.S.W.R (2400 ~ 2500MHz)			1.5		
Relative Attenuation (Reference level: 0dB)	24			dB	800 ~ 960MHz
	20				1710 ~ 1990MHz
	25				4800 ~ 5000MHz
	25				7200 ~ 7500MHz
Characteristic Impedance		50		$\Omega$	
Operation Temperature Range	-40		+85	°C	
Storage Temperature Range	-10		+40	°C	RH 70% Max

## CHARACTERISTIC CURVE:

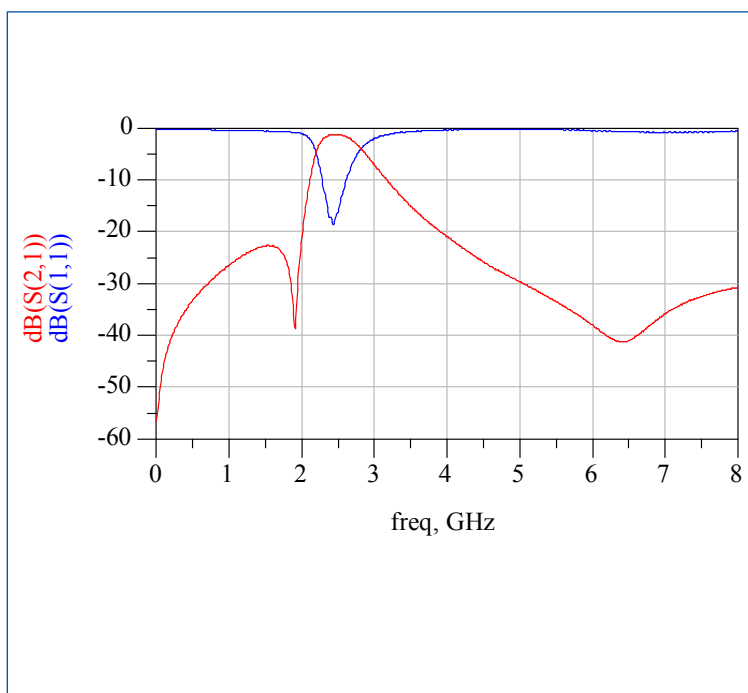

## REFLOW PROFILE:

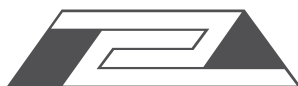
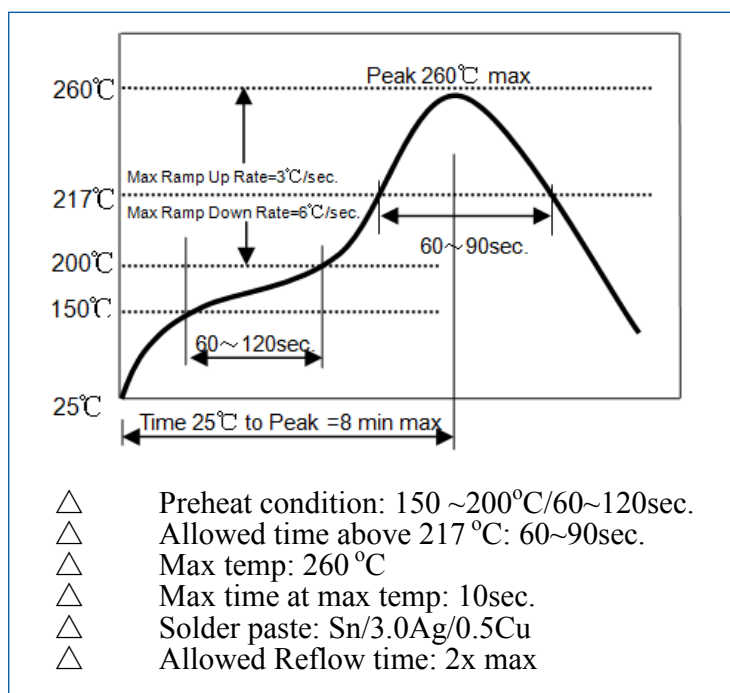

# SMD 2.45GHz Dielectric Band Pass Filter

ADFC18-2450.00-A-T



RoHS  
Compliant

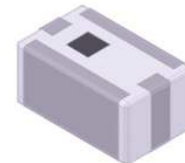

1.6 x 0.8 x 0.60 mm

## OUTLINE DRAWING:

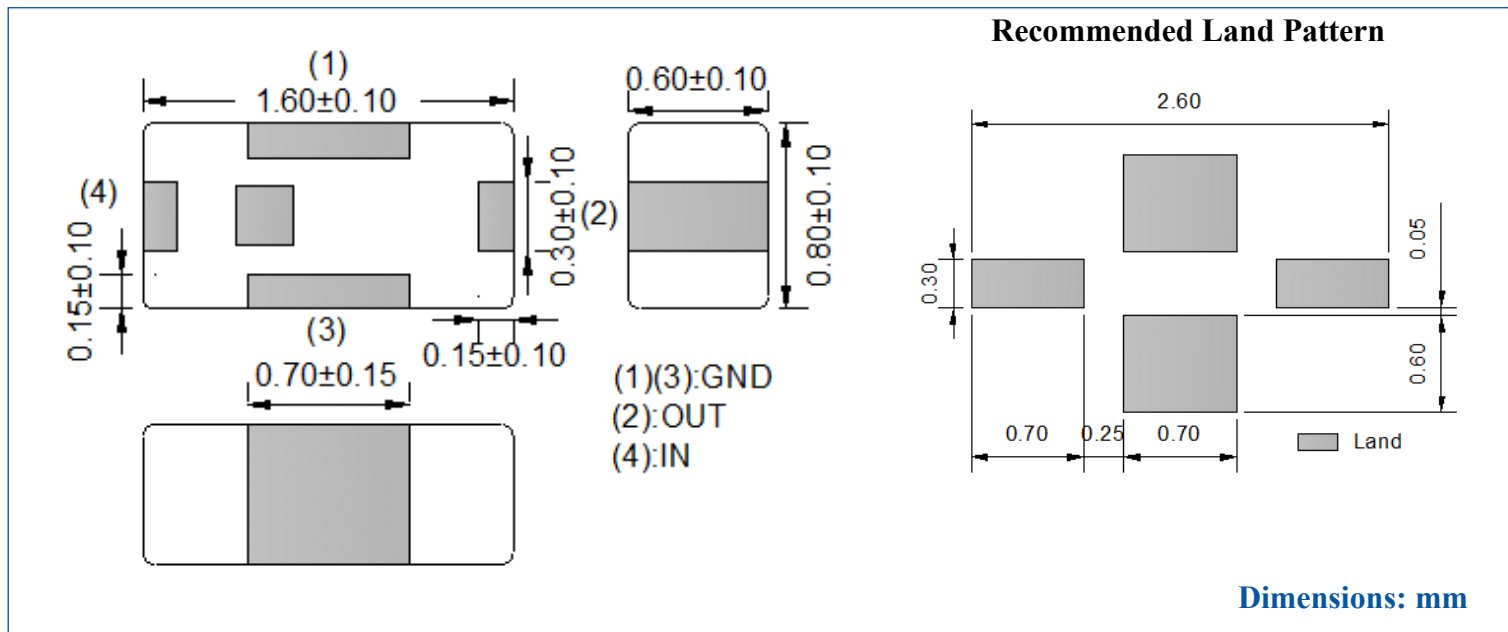

## TAPE & REEL:

Packaging: 4,000pcs/reel

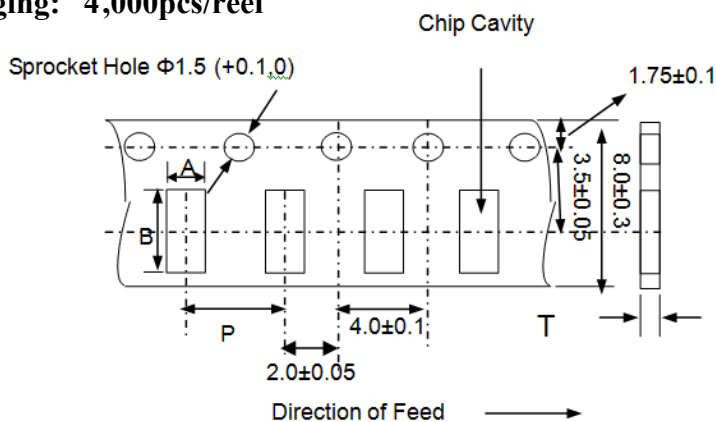

A	B	P	T max
1.00±0.10	1.80±0.10	4.0±0.10	0.75

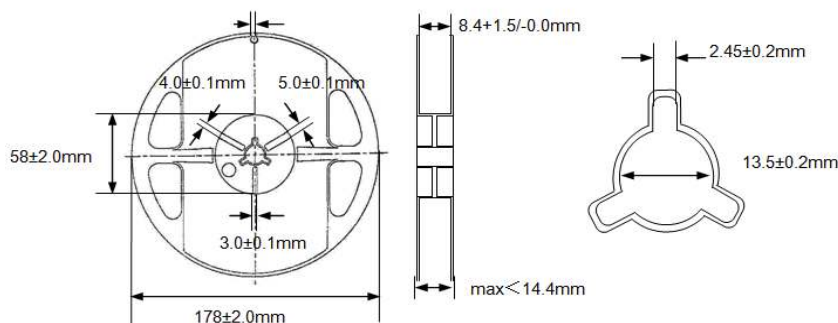

Dimensions: mm

**ATTENTION:** Abracon Corporation's products are COTS – Commercial-Off-The-Shelf products; suitable for Commercial, Industrial and, where designated, Automotive Applications. Abracon's products are not specifically designed for Military, Aviation, Aerospace, Life-dependant Medical applications or any application requiring high reliability where component failure could result in loss of life and/or property. For applications requiring high reliability and/or presenting an extreme operating environment, written consent and authorization from Abracon Corporation is required. Please contact Abracon Corporation for more information.

ABRACON IS  
ISO 9001:2008  
CERTIFIED



**ABRACON**  
CORPORATION

Visit [www.abracon.com](http://www.abracon.com) for Terms & Conditions of Sale  
30332 Esperanza, Rancho Santa Margarita, California 92688  
tel 949-546-8000 | fax 949-546-8001 | [www.abracon.com](http://www.abracon.com)

Revised: 12.03.12