

Messrs. Digi-Key

Issue No. : PC-02-064

Date of issue : November 15, 2002

Classification :  New  Change  Renewal

## Delivery Specification

Product Description : Balun

Product Part Number : EHF2BE0920

Classification of Spec : Individual Product Specification

Applications : Cellular phone

For other applications, contact the undersigned in advance.

Term of Validity : November 14, 2007 from the date of issue.

CUSTOMER USE ONLY	Receipt Record#:
This was certainly received by us. 1(one) copy is being returned to you.	Date of receipt:
	Received by:
	Title:
	Dept.:

Matsushita Electronic Components Co., Ltd.  
Network Device Company  
Module Strategic Business Unit  
Engineering Group HFD Team  
992-1 Aiba Ohno-cho Ibi-gun Gifu 501-0598 JAPAN  
Tel: +81-0585-36-2322  
Fax: +81-0585-36-2344

Prepared by	: H. Ito
Checked by	: M. Mizuno
Authorized by	: M. Mizuno
Title	: Manager of Engineering

[Shape, appearance, dimension] Unit: mm

<Top view>

<Bottom and side view>

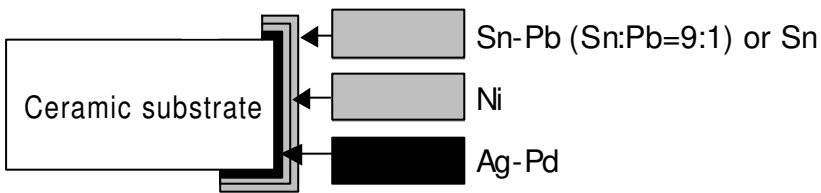
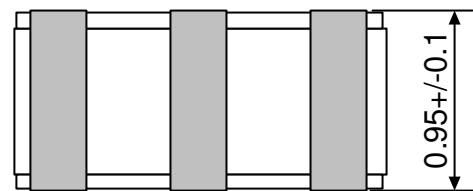
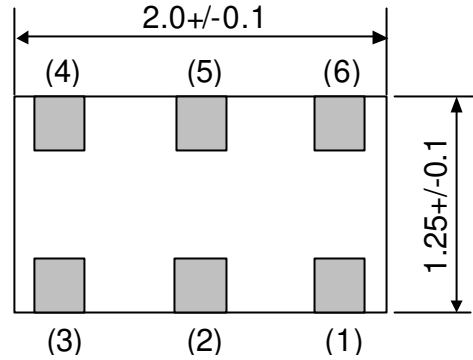
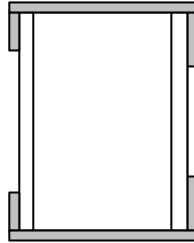
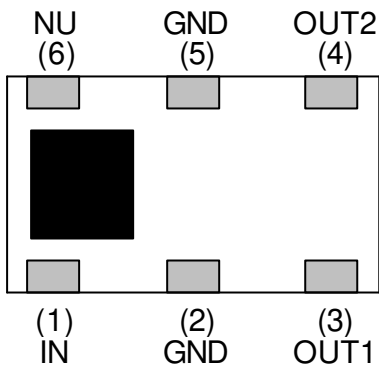

Note 1) "typ" is used where no dimensional tolerance applies.

Item	Description
Appearance/ construction	Product surface shall be covered with a protective film, which does not easily separate nor present noticeable unevenness, scratches, pinholes, color changes etc.
	Terminals shall ensure practically acceptable quality.
	Substrate shall be as shown in the drawing with no excessive chippings, scratches, burrs, or cracks.
Marking	Shall be legible in black (with printing paste).
Remarks	■ marked side for pin 1.

Balun		Delivery Specification			EHF2BE0920 Appearance	
Enact. Date November 15, 2002	P.S.M	Approval	Check	Plan	Drawing No. 151-EHF-2BE0920 9-1	
Enfo. Date November 15, 2002	-----	M. Mizuno	M. Mizuno	H. Ito		

[Absolute maximum ratings]

No.	Item	Symbol	Rating	Unit	Remarks
1	Maximum input power	Pmax	100	mW	DC voltage is 0V.
2	Operating temperature	Topr	-30...+85	degC	
3	Storage temperature	Tstg	-40...+85	degC	

Note: This component cannot apply a DC Bias.

[Electrical characteristics]

T=-30...+85degC

No.	Item	Test Circuit	Specification			Unit
			Min.	Typ.	Max.	
1	Frequency	-	880	-	960	MHz
2	Insertion loss (Back to back)	Fig-2	-	-	1.0	dB
3	Unbalance impedance	-	-	50	-	ohm
4	Balance impedance	-	-	100	-	ohm
5	Unbalance port VSWR	Fig-1	-	-	2.0	-
6	Amplitude balance	Fig-1	-1.5	-	1.5	dB
7	Phase balance	Fig-1	165	180	195	deg

[Internal circuitry]

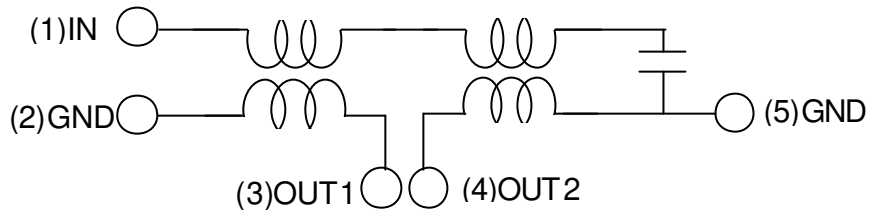

[Measuring circuit]

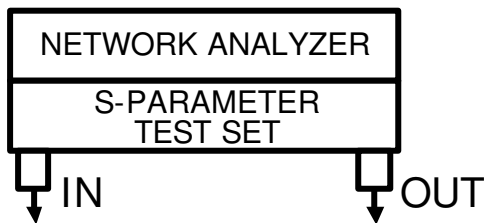
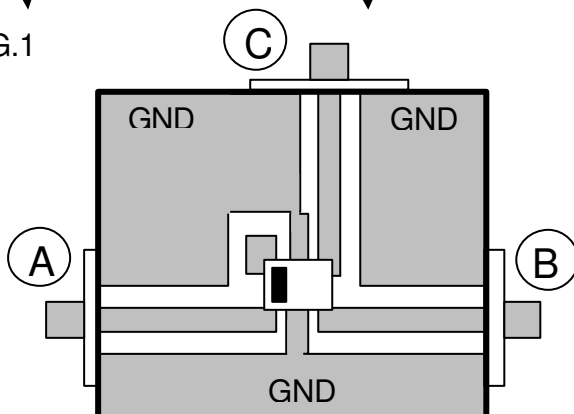

FIG.1



< Phase balance measurement >

- Phase1  
A=IN, B=OUT, C=Terminal resistor (50 ohm)
- Phase2  
A=IN, C=OUT, B=Terminal resistor (50 ohm)
- Phase balance  
Phase balance=Phase1-Phase2

< Insertion loss measurement >

Assuming the loss as "Loss" when D=IN, E=OUT  
Insertion loss for a device is "Loss"/2

FIG.2

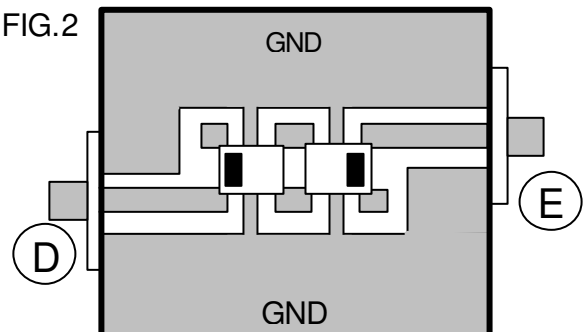

Balun		Delivery Specification			EHF2BE0920 Specification and measurement
Enact. Date November 15, 2002	P.S.M	Approval	Check	Plan	
Enfo. Date November 15, 2002	-----	M. Mizuno	M. Mizuno	H. Ito	Drawing No. 151-EHF-2BE0920 9-2

[Terminal dimensions] Unit: mm

<Bottom>

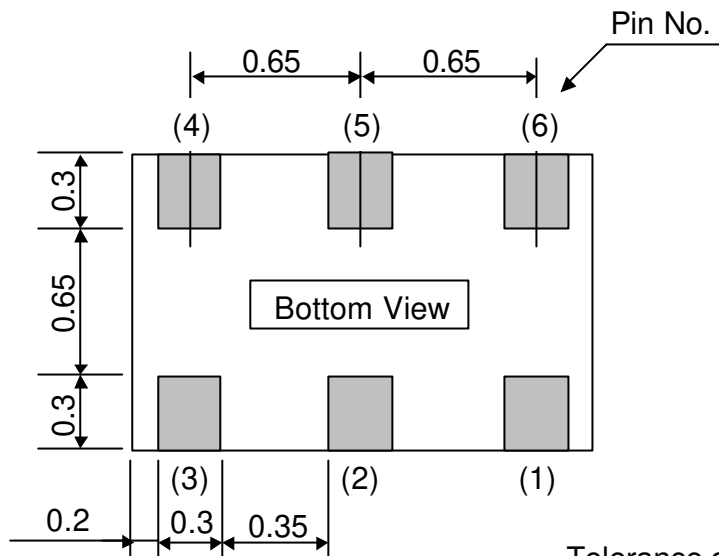

Tolerance of Terminal dimensions : +/-0.15

[Recommended PCB pad dimensions] Unit: mm

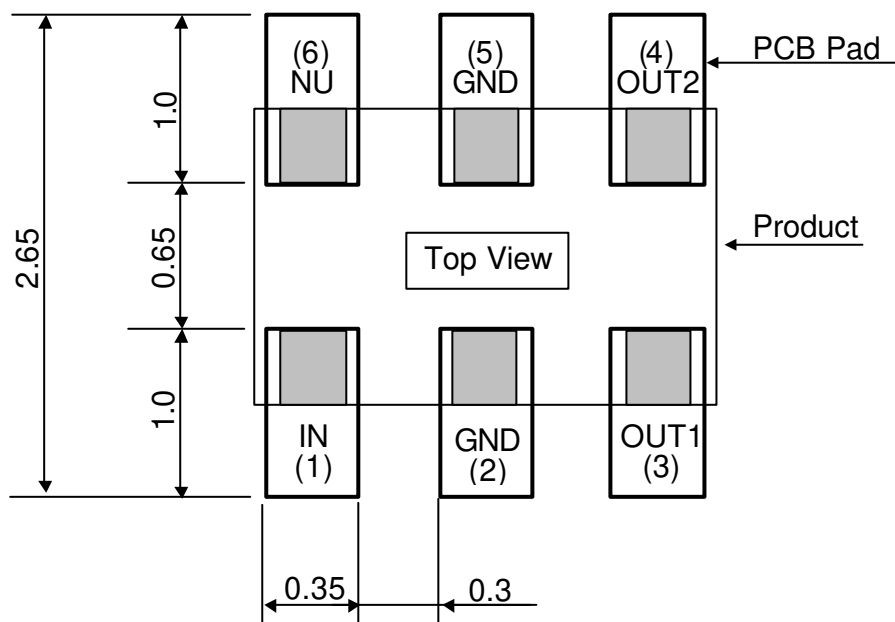

Balun		Delivery Specification			EHF2BE0920	
Enact. Date November 15, 2002		P.S.M	Approval	Check	Plan	Terminals/Recommended lands
Enfo. Date November 15, 2002		-----	M. Mizuno	M. Mizuno	H. Ito	Drawing No.
						151-EHF-2BE0920 9-3

[Quality characteristics]

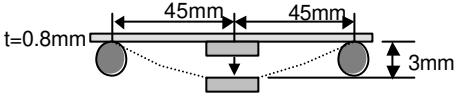
Test item	Test condition	Judgment criteria
High temperature	+85degC, 1000h	No abnormality shall be observed in appearance or electrical characteristics.
Low temperature	-40degC, 1000h	
High-temperature high-humidity storage	+60degC, 90%RH, 1000h	
Pressure Pot	+121degC, 99%RH, 2.026x10 <sup>5</sup> Pa, 100h	
Temperature cycling	-40...+85degC, Each 30 min., 200cy	
Vibration	10...500Hz, 10G, in each direction of XYZ, 2h30min.	
Impact	100G, 6mS, Half sinusoidal wave, in each direction of XYZ, 3 times	
Shock (Drop)	1.8m, 6 facesx6cy(36 times with 100g Dummy Load)	
Electro static discharge	200pF, 0 ohm, +/-200V, Each 5 times	
Soldering heat resistance	Manual hot gas: 260+/-10degC, 30 sec., 2 times	Over 90% of the terminal surface shall be covered with solder.
	Soldering iron: 260+/-10degC, 3 sec., 2 times	
	Reflow: 260degC peak, 2 times	
Solder ability	Solder bath: 235+/-5degC, 2 sec.	Over 95% of the terminal surface shall be covered with solder.
	Reflow: 230degC	
Board warping	Assemble this component on a PC board with 0.8mm thickness using the recommended soldering condition shown below, and apply a bending force of 3mm warping at a rate of 1mm/sec. 5 seconds and 5 times. 	There should not be any cracks in the component or solder joints, no abnormality in electrical characteristics.
Terminal removal	Solder a component on a PC board using the recommended condition shown below and then press the component sideways at 1mm/sec. Destruction limit 9.8N or greater.	
Seating plane co-planarity	Within 0.1mm	

< Recommended soldering condition >

Diagram1 Shown below is a recommended reflow soldering condition.

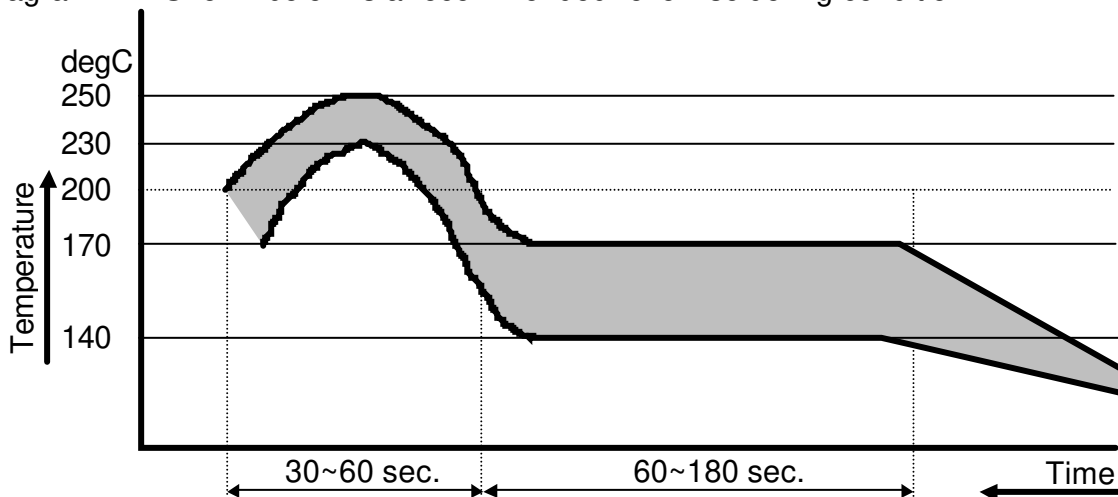

Balun		Delivery Specification			EHF2BE0920 Quality Characteristics
Enact. Date November 15, 2002	P.S.M	Approval	Check	Plan	
Enfo. Date November 15, 2002	----	M. Mizuno	M. Mizuno	H. Ito	Drawing No. 151-EHF-2BE0920 9-4

[Cautions for use]

- (1) Operating a product over the maximum rating for even a moment may result in a product failure or breakage. Never use a product in such a condition that it may cause a safety problem.
- (2) Opening or short-circuiting the product terminals or inserting a product in the reverse orientation while power is being supplied may cause a breakage. Always avoid such circumstances.
- (3) Operations in a corrosive gas atmosphere or improper environments such as high-temperature, high-humidity or dewy conditions may lead to product performance deterioration, a breakage, a change in appearance etc. Please avoid such conditions, as they are unsafe.
- (4) Always ground the soldering iron or soldering bath used for assembly operation to avoid any excessive voltage applied to a product.
- (5) After soldering with solder bridges, incomplete soldering or in the reverse orientation, supplying power may result in a product breakage. Please confirm the soldered condition before supplying power to the product.
- (6) Excessive stress on the terminals may cause a contact failure or performance deterioration. Please use caution.
- (7) Please provide a fail-safe provision in the product you design by taking any failure of our product into consideration.
- (8) This product does not include a DC-cutting device. Application of a DC voltage between the Balance port and the Unbalance port may cause product deterioration or breakage.

\* If any question arises about the safety of this product, please contact us immediately with a request for an engineering examination.

[Remarks]



- \*1: All of the materials used in this product are those listed as the existing chemical substances based on the "Law for examination and regulation of manufacture of chemical substances".
- \*2: The production process of this product does not use any ozone-depleting chemicals (OZC) regulated by the Montreal Protocol.
- \*3: Validity of this specification is 5 years from the date of issue, but the validity is considered on going unless any changes are made.

Balun		Delivery Specification			EHF2BE0920 Cautions
Enact. Date November 15, 2002	P.S.M	Approval	Check	Plan	
Enfo. Date November 15, 2002	-----	M. Mizuno	M. Mizuno	H. Ito	Drawing No. 151-EHF-2BE0920 9-5

[Packaging materials]

1. Materials
- 1) Embossed carrier tape (Refer to the attachment)
  - 2) Top tape: Anti-static
  - 3) Packaging box (Refer to the attachment)
  - 4) Packaging tape, carrier-securing adhesive tape

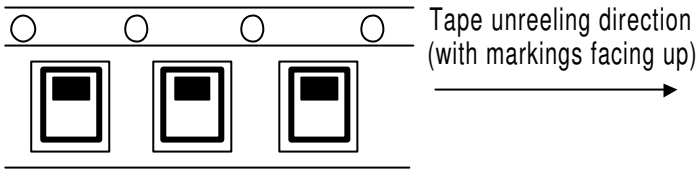
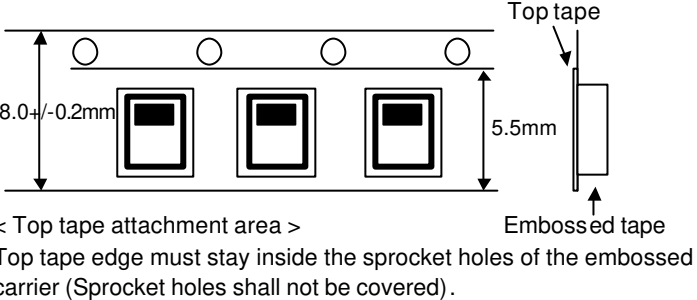
2. Specification

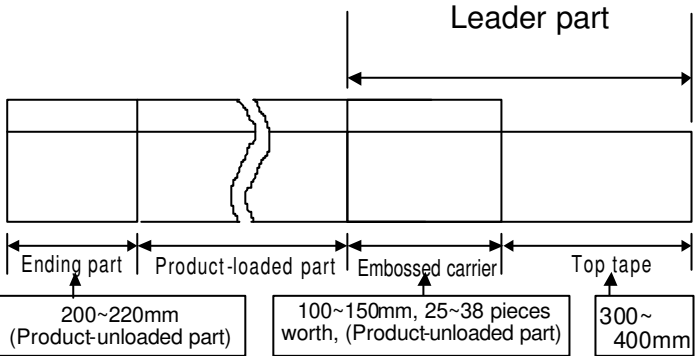
No.	Item	Condition	Remarks
1	Reel outer diameter	Refer to the attachment.	
2	Reel inner diameter	Refer to the attachment.	
3	Reel inner width	Refer to the attachment.	
4	Quantity in a reel	4000 pieces/reel	
5	Taping direction		
6	Top tape attachment position		Tape breaks force. Min. 10N Top cover tape strength. Min. 10N Tape peel force. 0.1...1.0N Tape peel angle. 165...180degree Reel weight. Max 1500g
7	Label attachment position		Indicated Item Pat No., Lot No. Quantity, Maker Country of Origin
8	Tape leader part and tape ending part		
9	Missing products	No missing products shall be allowed.	
10	Packaged quantity in a box	21 reels/box (Max)	84000 pieces/box(Max)

Balun					Delivery Specification		EHF2BE0920	
Enact. Date November 15, 2002			P.S.M	Approval	Check	Plan	Packaging specification 1	
Enfo. Date November 15, 2002			-----	M. Mizuno	M. Mizuno	H. Ito	Drawing No.	
							151-EHF-2BE0920 9-6	

1. Method

- 1) Load products in each cavity of an embossed carrier tape, in the correct orientation, by leaving the product-unloaded part shown in Item No. 8(P9-6) of the packaging specification.
- 2) Heat-seal a top tape in good alignment on the carrier tape.
- 3) After 4000 pieces are loaded and reeled, provide a product-unloaded part at the tape-leader portion. Secure the tip of the carrier tape with a piece of adhesive tape.
- 4) Stack the reels (21 reels max.) and enclose them in a packaging box. Close the flaps with a piece of adhesive tape.
- 5) Provide markings on the packaging box.

< Items to be indicated >

1. Part No.
2. Quantity
3. Lot No.
4. Manufacturer name
5. Country of origin

Marking on the packaging box

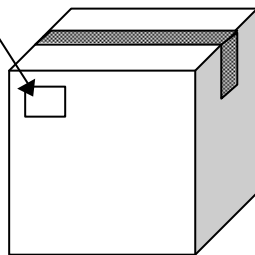

Packaging box shape varies with the number of reels enclosed.

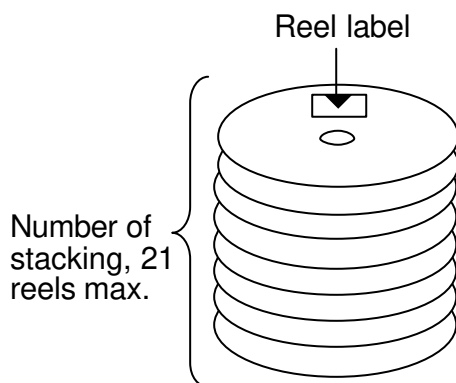
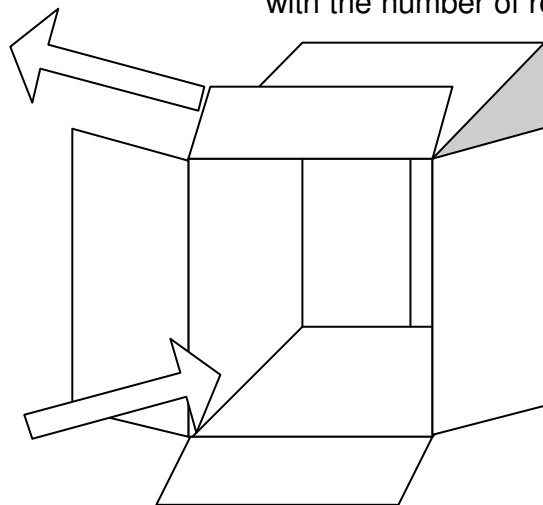

\* Insert cushion material in the empty spaces to secure reels.

Balun		Delivery Specification			EHF2BE0920 Packaging specification 2
Enact. Date November 15, 2002	P.S.M	Approval	Check	Plan	
Enfo. Date November 15, 2002	-----	M. Mizuno	M. Mizuno	H. Ito	Drawing No. 151-EHF-2BE0920 9-7



[Embossed tape dimensions] Unit: mm

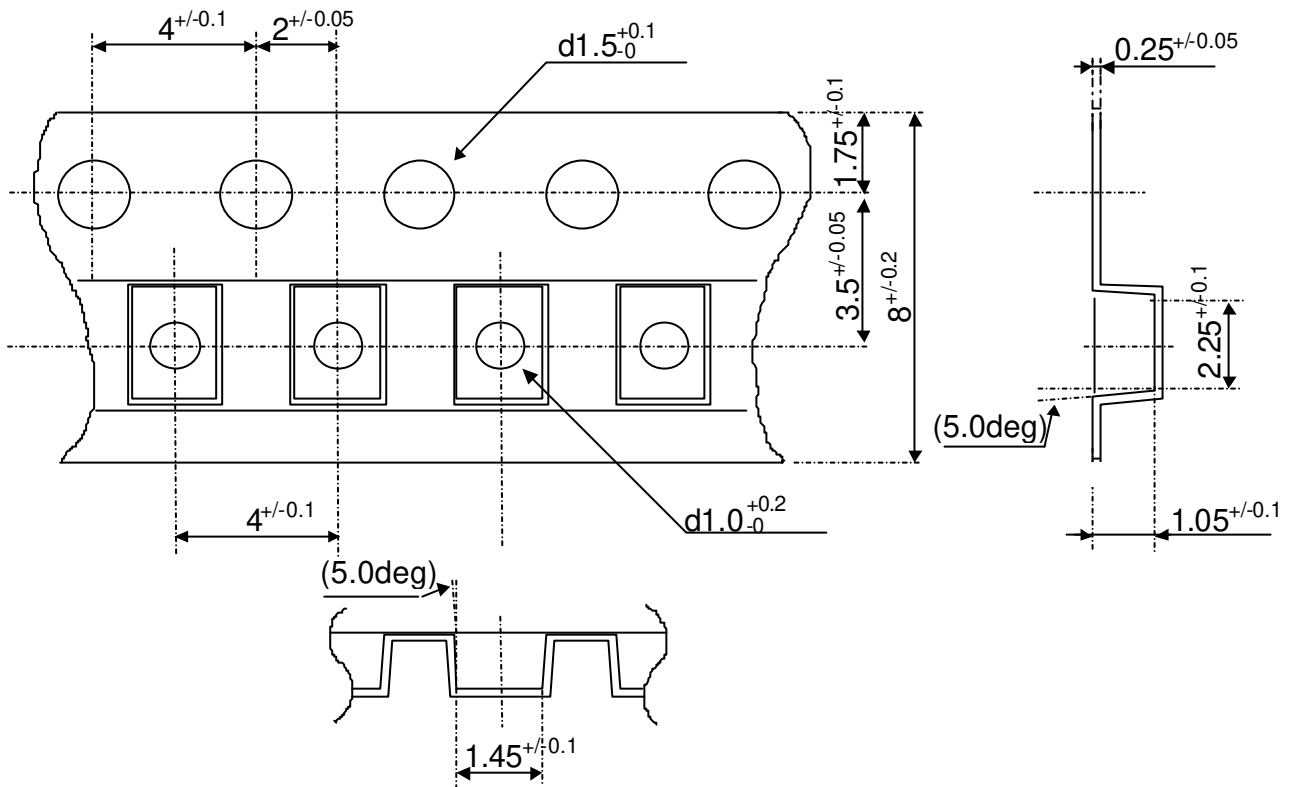

<Remarks>

- (1) Unspecified corner radius shall be 0.3mm max.
- (2) Cumulative pitch error of sprocket holes shall be  $+/-0.2$ mm for 10 pitches.

Balun		Delivery Specification			EHF2BE0920 Packaging specification 3
Enact. Date November 15, 2002	P.S.M	Approval	Check	Plan	
Enfo. Date November 15, 2002	----	M. Mizuno	M. Mizuno	H. Ito	Drawing No. 151-EHF-2BE0920 9-8

[Reel dimensions] Unit: mm

(1) This reel conforms to EIAJ-RRM-08B based on EIAJ standard.

(2) Material: PS (Polystyrene)

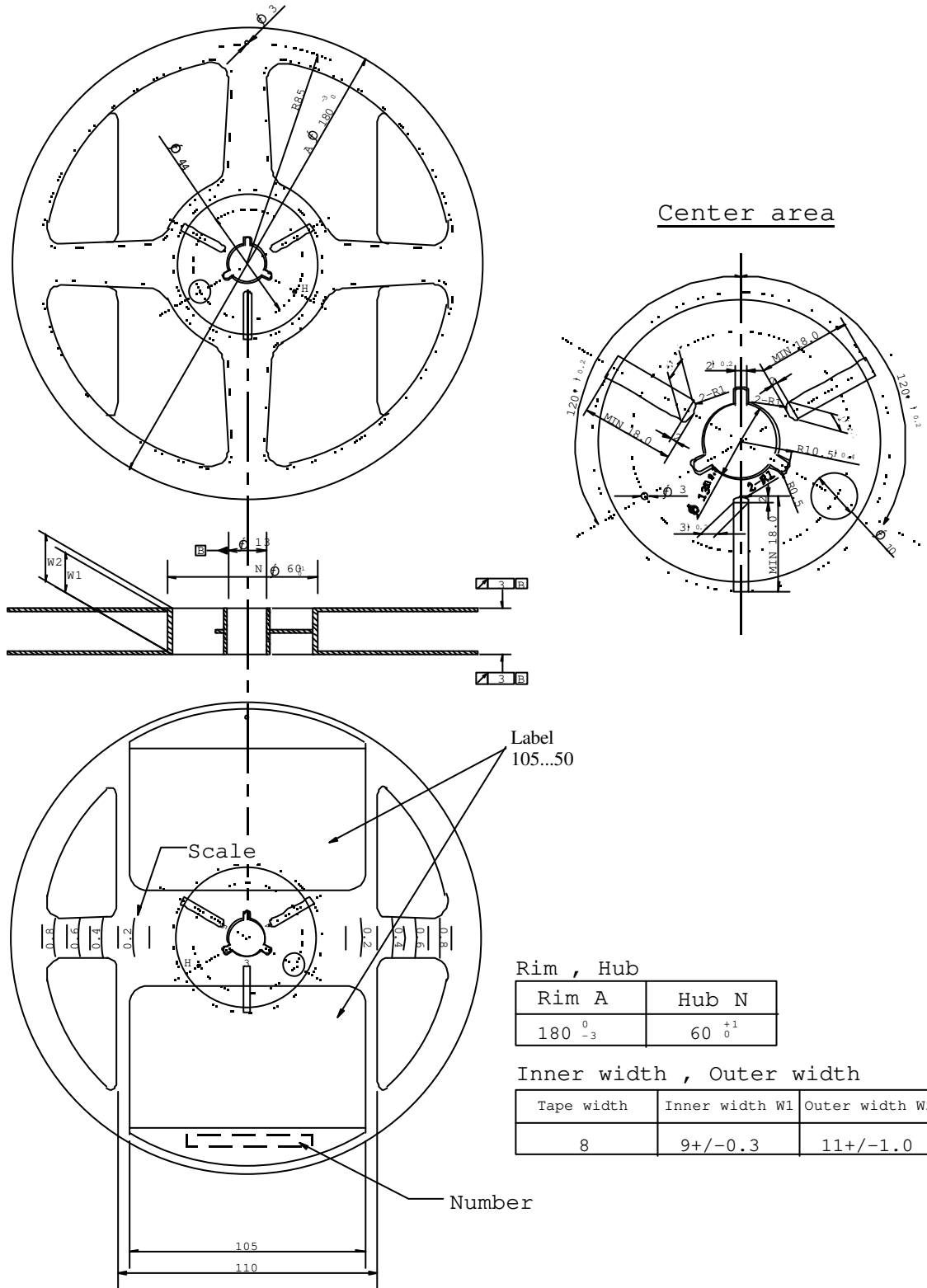

Rim , Hub

Rim A	Hub N
180 <sup>0</sup> <sub>-3</sub>	60 <sup>+1</sup> <sub>0</sub>

Inner width , Outer width

Tape width	Inner width W1	Outer width W2
8	9+/-0.3	11+/-1.0

Balun		Delivery Specification			EHF2BE0920	
Enact. Date November 15, 2002	P.S.M	Approval	Check	Plan	Packaging specification 4	
Enfo. Date November 15, 2002	----	M. Mizuno	M. Mizuno	H. Ito	Drawing No. 151-EHF-2BE0920 9-9	