

# SPDT Reflective Switch

## 1 - 5 GHz



MASW-011184

Rev. V1

### Features

- 0.35 dB TX Insertion Loss
- 0.5 dB RX Insertion Loss
- 41 dBm Input P0.1dB on TX Path
- 18 dB Typical Return Loss at Each RF Port
- Compatible with 1.8V CMOS Logic
- 3 mm 16-Lead PQFN Package
- RoHS\* Compliant

### Applications

- ISM
- Multi Market

### Description

The MASW-011184 is a single pole double throw (SPDT) switch with 0.35 dB of insertion loss in the TX path and 0.5 dB insertion loss in the RX path. The TX path is capable of handling 10 W input power. The input and output return losses in the thru path are typically 18 dB. The logic levels are standard 1.8 V CMOS. Only a single positive supply of +5 V is required.

The MASW-011184 is designed for transmit/receive applications between 1 and 5 GHz. The 3 mm PQFN package is lead free and RoHS compliant.

### Ordering Information<sup>1,2</sup>

Part Number	Package
MASW-011184-TR1000	1000 piece reel
MASW-011184-TR3000	3000 piece reel
MASW-011184-SMB	Sample Board

1. Reference Application Note M513 for reel size information.
2. All sample boards include 5 loose parts.

### Functional Schematic

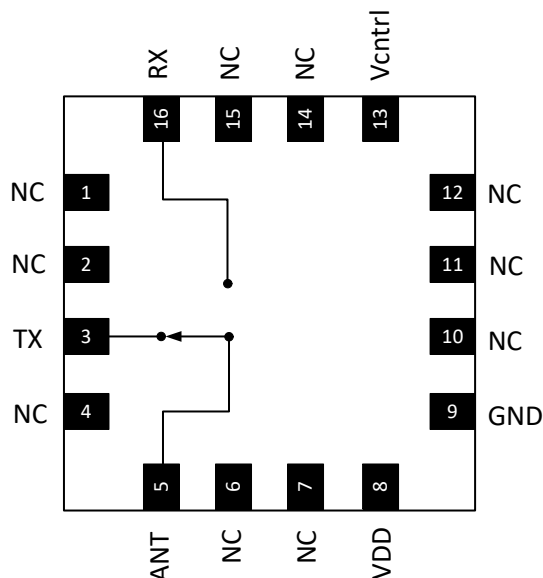

### Pin Configuration<sup>3</sup>

Pin #	Pin Name	Description
1,2,4,6,7,10,11,12,14,15	NC <sup>4</sup>	No Connection
3	TX <sup>5</sup>	TX Input/Output
5	ANT <sup>5</sup>	Common Port
8	VDD	+5V
9	GND	Ground
13	Vcntrl	Control Input
16	RX <sup>6</sup>	RX Input/Output

3. The exposed pad centered on the package bottom must be connected to RF, DC and thermal ground.
4. MACOM recommends connecting No Connection (N/C) pins to ground.
5. There are internal DC blocking capacitors at ANT and TX ports.
6. External DC blocking capacitor is required at RX port.

\* Restrictions on Hazardous Substances, compliant to current RoHS EU directive.

# SPDT Reflective Switch

## 1 - 5 GHz



MASW-011184

Rev. V1

**Electrical Specifications:  $V_{DD} = +5.0\text{ V}$ ,  $T_{BASE} = +25^{\circ}\text{C}$ ,  $Z_0 = 50\ \Omega$**

Parameter	Test Conditions	Units	Min.	Typ.	Max.
Insertion Loss, ANT to TX	1.0 GHz	dB	—	0.38	—
	2.5 GHz			0.30	0.9
	5.0 GHz			0.38	1.0
Insertion Loss, ANT to RX	1.0 GHz	dB	—	0.57	—
	2.5 GHz			0.34	1.0
	5.0 GHz			0.65	1.3
Isolation, ANT to RX in TX Mode	1.0 GHz	dB	—	39	—
	2.5 GHz		32	38	
	5.0 GHz		24	29	
Isolation, TX to RX in TX Mode	1.0 GHz	dB	—	39	—
	2.5 GHz			35	—
	5.0 GHz			27	—
Isolation, ANT to TX in RX Mode	1.0 GHz	dB	—	36	—
	2.5 GHz		23	27	
	5.0 GHz		17	21	
Isolation, TX to RX in RX Mode	1.0 GHz	dB	—	39	—
	2.5 GHz			34	—
	5.0 GHz			27	—
ANT Port Return Loss	1.0 - 5.0 GHz	dB	—	18	—
TX Port Return Loss in TX Mode	1.0 - 5.0 GHz	dB	—	18	—
RX Port Return Loss in RX Mode	1.0 - 5.0 GHz	dB	—	18	—
TX Input P0.1dB	1.0 - 5.0 GHz	dBm	—	41	—
RX Input P0.1dB	1.0 - 5.0 GHz	dBm	—	30.5	—
TX Input IP3	+20 dBm per tone, 10 MHz spacing	dBm	—	54.5	—
RX Input IP3	+15 dBm per tone, 10 MHz spacing	dBm	—	49	—
	1.0 GHz			55	—
	2.5 GHz			51	—

# SPDT Reflective Switch

## 1 - 5 GHz



MASW-011184

Rev. V1

**Electrical Specifications:  $V_{DD} = +5.0\text{ V}$ ,  $T_{BASE} = +25^{\circ}\text{C}$ ,  $Z_0 = 50\ \Omega$**

Parameter	Test Conditions	Units	Min.	Typ.	Max.
Switching Speed, TX Mode $T_{ON}$ $T_{OFF}$ $T_{RISE}$ $T_{FALL}$	50% control to 90% Voltage 50% control to 10% Voltage 10% to 90% Voltage 90% to 10% Voltage	ns	—	410 135 140 45	—
Switching Speed, RX Mode $T_{ON}$ $T_{OFF}$ $T_{RISE}$ $T_{FALL}$	50% control to 90% Voltage 50% control to 10% Voltage 10% to 90% Voltage 90% to 10% Voltage	ns	—	190 80 40 26	—
Supply Voltage, VDD	—	V	+4.75	+5.0	+5.25
VDD Quiescent Current	TX Mode RX Mode	mA	—	1.4 6.0	—
Vcntrl Control Voltage	Logic High, $V_{IH}$ Logic Low, $V_{IL}$	V	+1.17 0	+1.8 0	+1.8 0.63
T/R Logic Input Current	Logic High, $V_{IH}$ Logic Low, $V_{IL}$	$\mu\text{A}$	—	40 +/-0.03	—

### Maximum Operating Ratings

Parameter	Maximum
Input Power, TX Path <sup>7</sup>	40 dBm
Input Power, RX Path <sup>7</sup>	29 dBm
VDD	-0.25 to +5.25 V
Vcntrl	0 to 1.8 V
Junction Temperature <sup>8</sup>	+125°C
Operating Temperature	-40°C to +105°C

7. Based on testing with input power applied for 30 seconds.

8. Guarantees  $10^6$  hour lifetime.

### Absolute Maximum Ratings<sup>9,10</sup>

Parameter	Absolute Maximum
Input Power, TX Path	41 dBm
Input Power, RX Path	30 dBm
VDD	-0.5 to +5.5 V
Vcntrl	-0.5 to +2.75 V
Storage Temperature	-55°C to +125°C

9. Exceeding any one or combination of these limits may cause permanent damage to this device.

10. MACOM does not recommend sustained operation near these survivability limits.

### Truth Table

Control Input	T/R Path	
	RX	TX
$V_{IH}$	On	Off
$V_{IL}$	Off	On

### Handling Procedures

Please observe the following precautions to avoid damage:

### Static Sensitivity

These electronic devices are sensitive to electrostatic discharge (ESD) and can be damaged by static electricity. Proper ESD control techniques should be used when handling these HBM Class 1 B devices.

# SPDT Reflective Switch 1 - 5 GHz



MASW-011184

Rev. V1

## PCB Layout

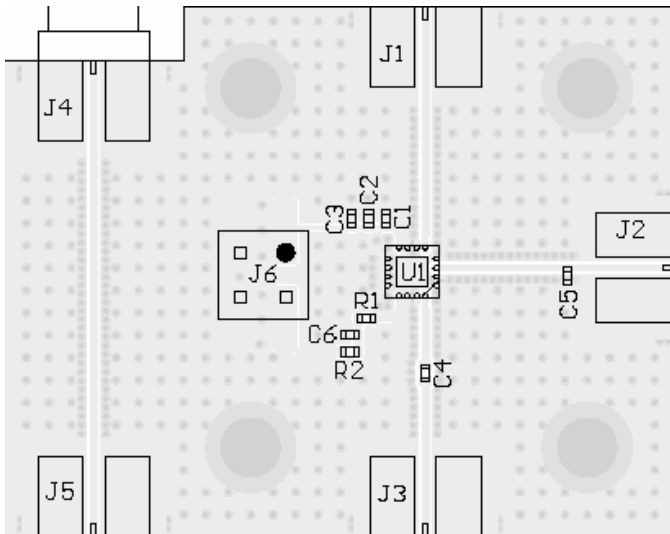

## Parts List

Part	Value	Case Style
C1	10 pF	0402
C2	1000 pF	0402
C3	1 $\mu$ F	0402
C4	8.2 pF	0402
C5	0.2 pF	0402 (100 V)
C6	5 pF	0402
R1,R2	0 $\Omega$	0402
J1 - J5	142-0761-841	SMA, End Launch

## Application Schematic

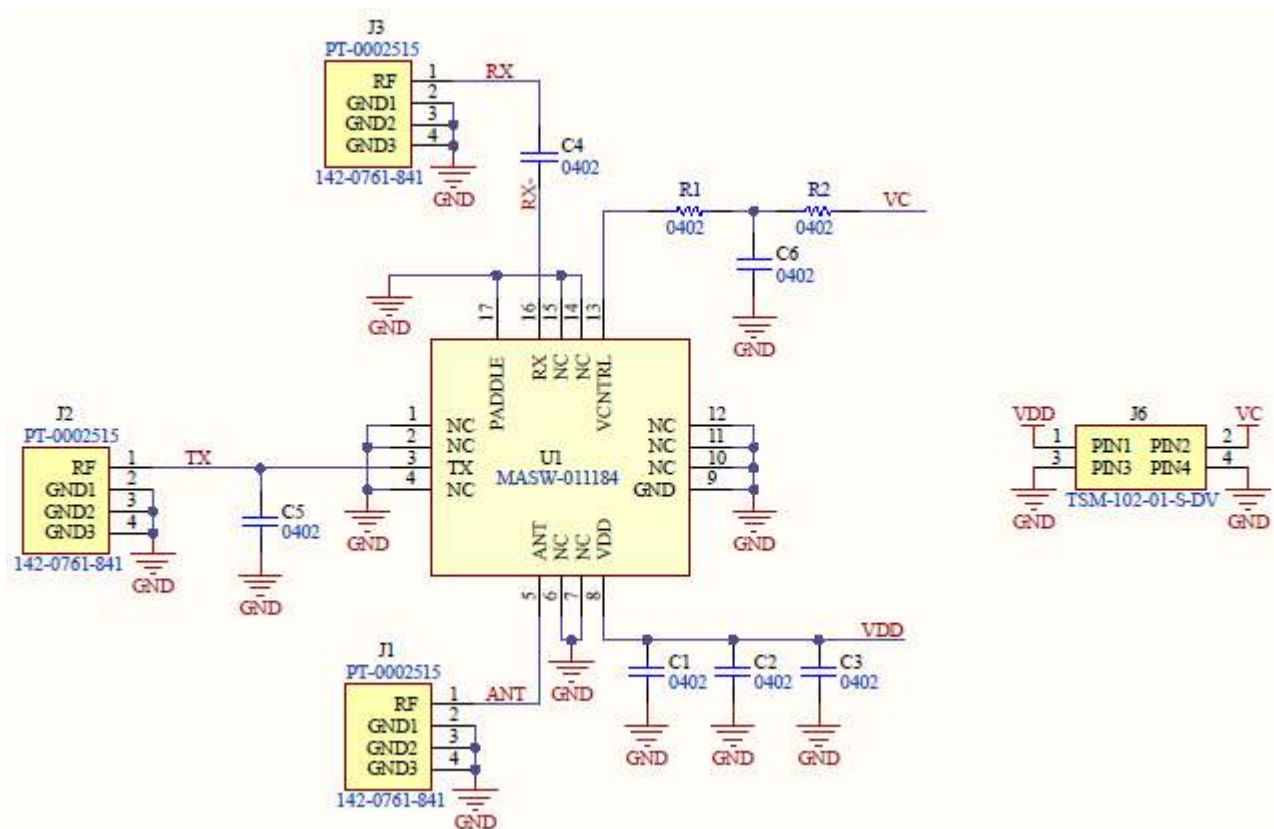

# SPDT Reflective Switch 1 - 5 GHz



MASW-011184

Rev. V1

## Typical Performance Curves

**Insertion Loss, ANT to TX**

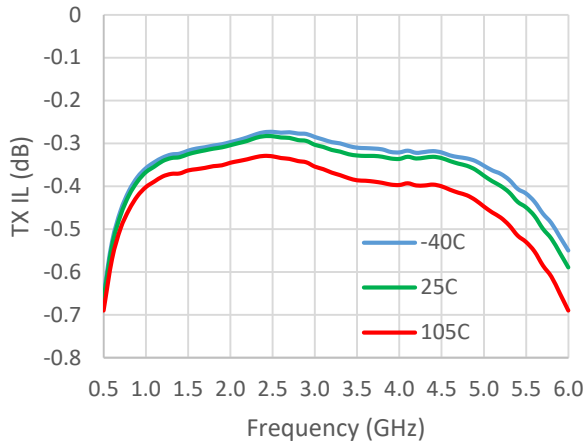

**Insertion Loss, ANT to RX**

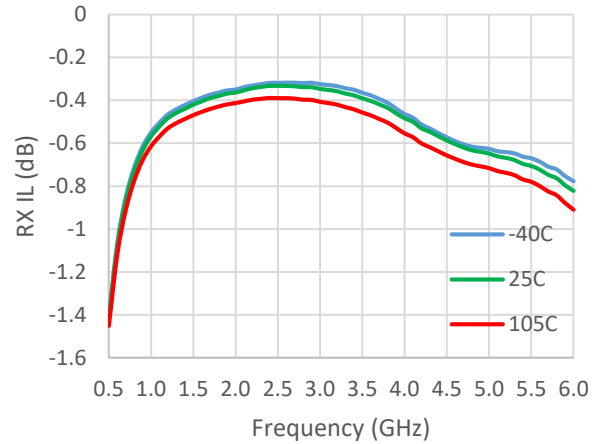

**Isolation, ANT to RX in TX Mode**

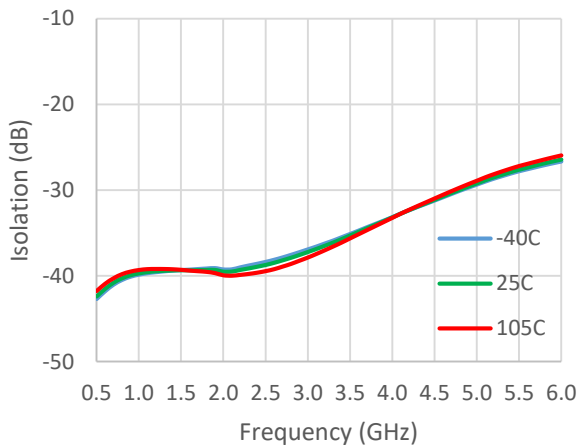

**Isolation, ANT to TX in RX Mode**

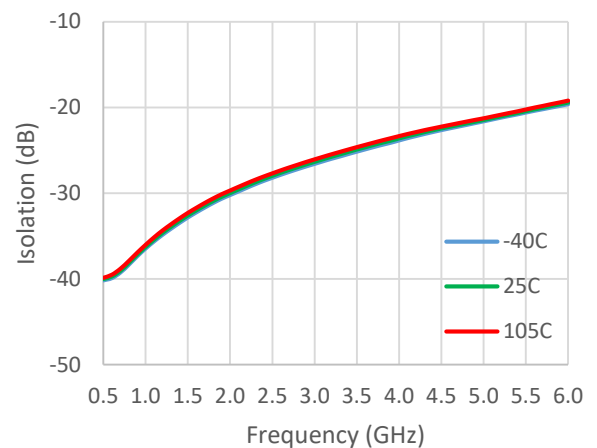

**Isolation, TX to RX in TX Mode**

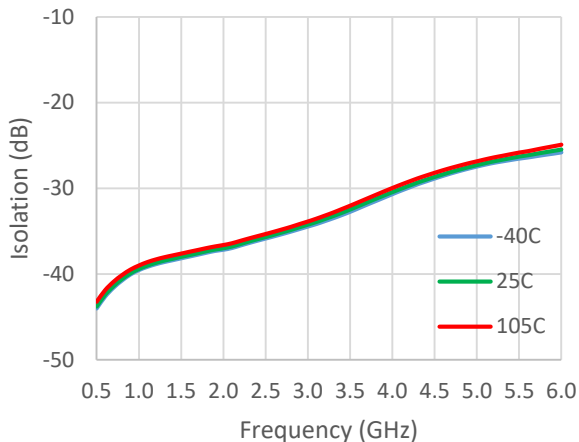

**Isolation, TX to RX in RX Mode**

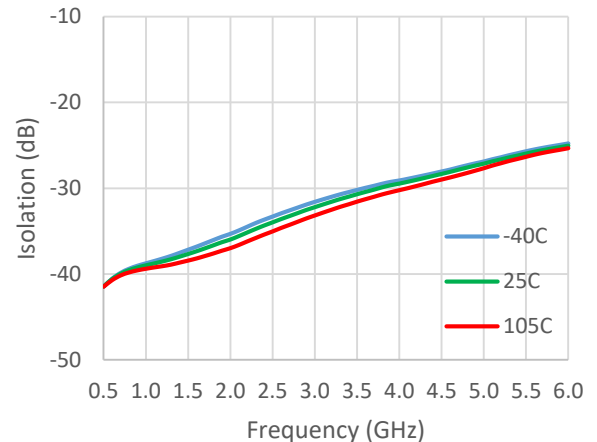

# SPDT Reflective Switch 1 - 5 GHz



MASW-011184

Rev. V1

## Typical Performance Curves

**ANT RL in TX Mode**

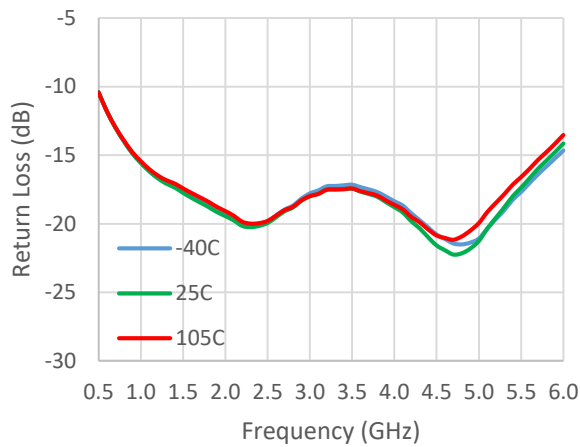

**ANT RL in RX Mode**

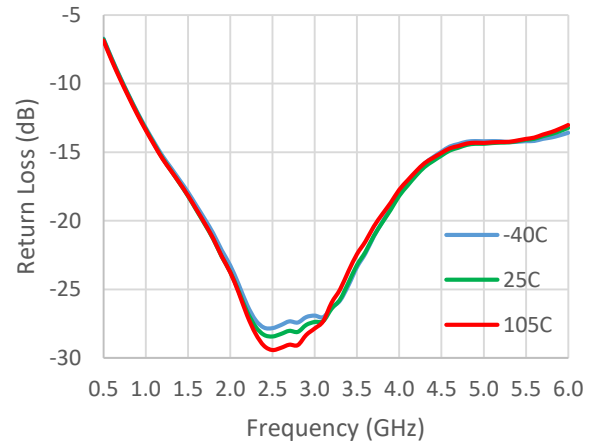

**TX RL**

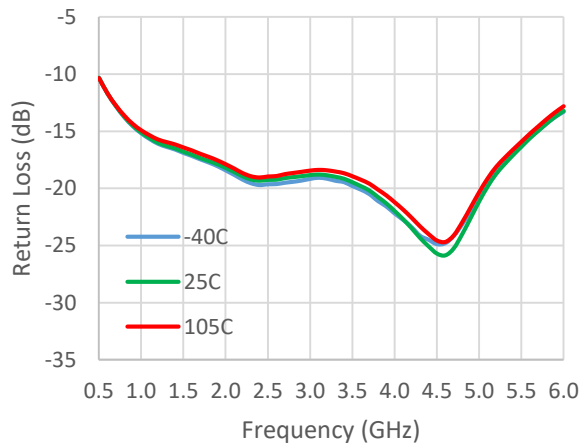

**RX RL**

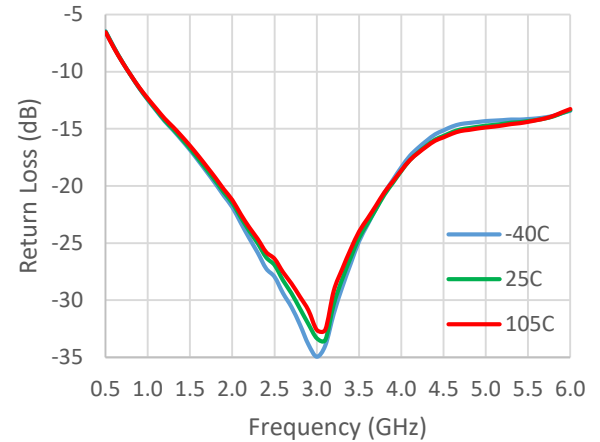

# SPDT Reflective Switch 1 - 5 GHz



MASW-011184

Rev. V1

## Lead-Free 3 mm 12-Lead PQFN†

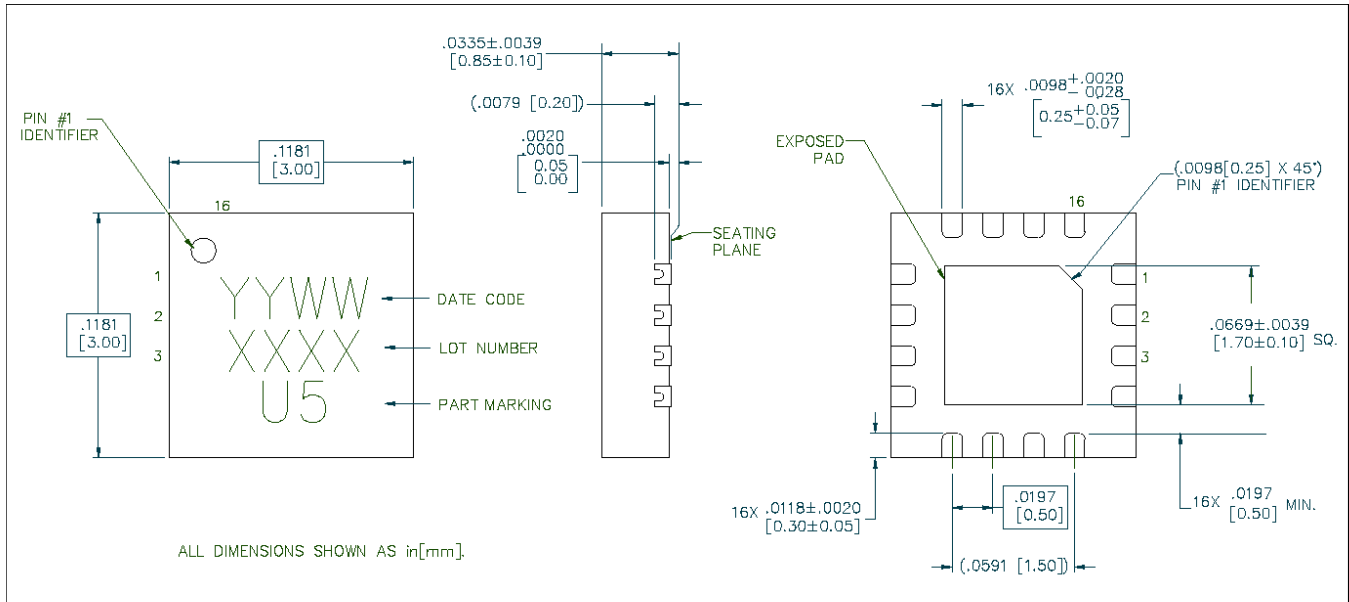

† Reference Application Note S2083 for lead-free solder reflow recommendations.  
Meets JEDEC moisture sensitivity level (MSL) 1 requirements.  
Plating is 100% matte tin over copper.

# SPDT Reflective Switch

## 1 - 5 GHz



MASW-011184

Rev. V1

MACOM Technology Solutions Inc. ("MACOM"). All rights reserved.

These materials are provided in connection with MACOM's products as a service to its customers and may be used for informational purposes only. Except as provided in its Terms and Conditions of Sale or any separate agreement, MACOM assumes no liability or responsibility whatsoever, including for (i) errors or omissions in these materials; (ii) failure to update these materials; or (iii) conflicts or incompatibilities arising from future changes to specifications and product descriptions, which MACOM may make at any time, without notice. These materials grant no license, express or implied, to any intellectual property rights.

THESE MATERIALS ARE PROVIDED "AS IS" WITH NO WARRANTY OR LIABILITY, EXPRESS OR IMPLIED, RELATING TO SALE AND/OR USE OF MACOM PRODUCTS INCLUDING FITNESS FOR A PARTICULAR PURPOSE, MERCHANTABILITY, INFRINGEMENT OF INTELLECTUAL PROPERTY RIGHT, ACCURACY OR COMPLETENESS, OR SPECIAL, INDIRECT, INCIDENTAL, OR CONSEQUENTIAL DAMAGES WHICH MAY RESULT FROM USE OF THESE MATERIALS.

MACOM products are not intended for use in medical, lifesaving or life sustaining applications. MACOM customers using or selling MACOM products for use in such applications do so at their own risk and agree to fully indemnify MACOM for any damages resulting from such improper use or sale.