

Annular RH Series Thermoelectric Cooler

The RH14-32-06-L1-W4.5 is an annular thermoelectric cooler that is round in shape. The hot and cold side ceramics have a circular hole in the center to accommodate light protrusion for optics, mechanical fastening or temperature probe. It has a maximum Qc of 12.4 Watts when $\Delta T = 0$ and a maximum ΔT of 70.5 °C at Qc = 0.

Features

- Center Hole
- Precise Temperature Control
- No sound or vibration
- Reliable solid-state
- DC Operation
- RoHS-compliant

Applications

- Thermoelectric Coolers for Reagent Storage
- Thermoelectric Coolers for Handheld Cosmetic Lasers
- Cooling for Centrifuges
- Heads-Up Displays, Imaging Sensors
- Peltier Cooling for Machine Vision

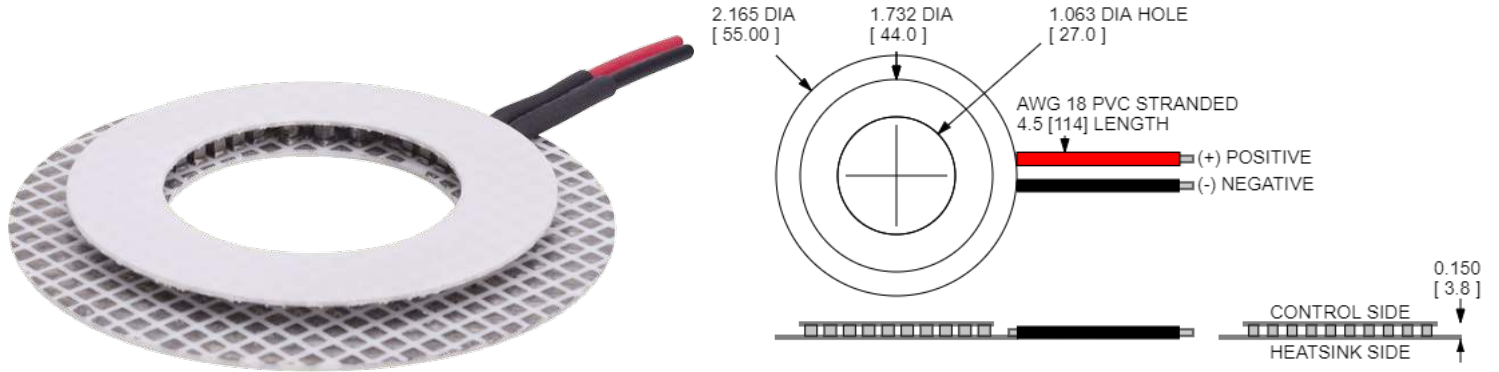

CERAMIC MATERIAL: Al₂O₃
 SOLDER CONSTRUCTION: 138°C, BiSn

INCHES [MM]

ELECTRICAL AND THERMAL PERFORMANCE

For maximum performance, be sure to orient the CONTROL side of the TEC against the application to be managed and the HEATSINK side against the heat sink or other heat rejection method. The CONTROL side is always opposite the side with lead attachments. Lead attachment is a passive heat loss and less impactful if located on the side that attaches to the heat exchanger.

Heat Pumped at Cold Side
 Thot = 27 °C

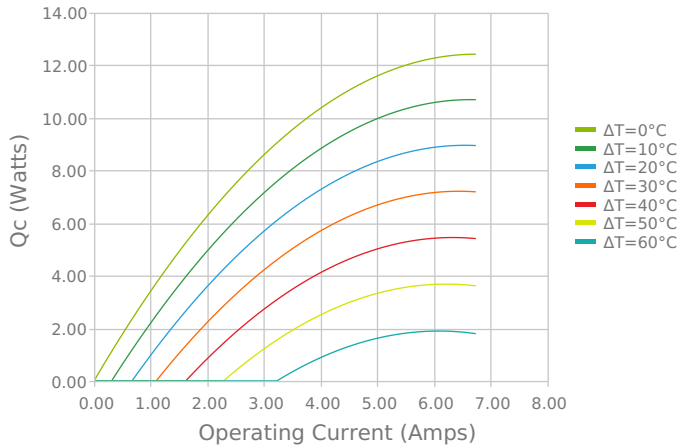

Heat Pumped at Cold Side
 Thot = 27 °C

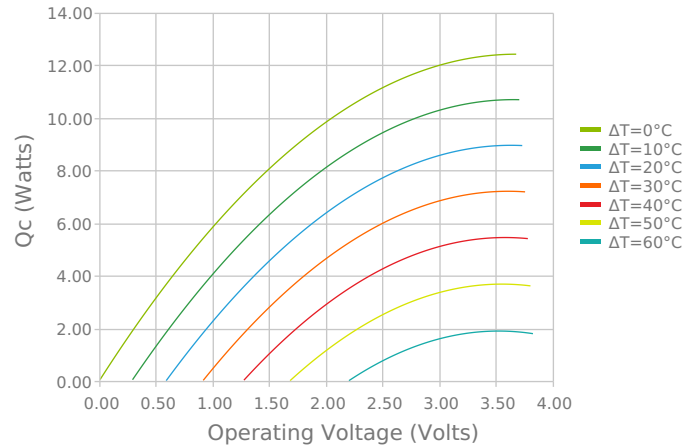

Current vs Voltage (I vs V)
 Thot = 27 °C

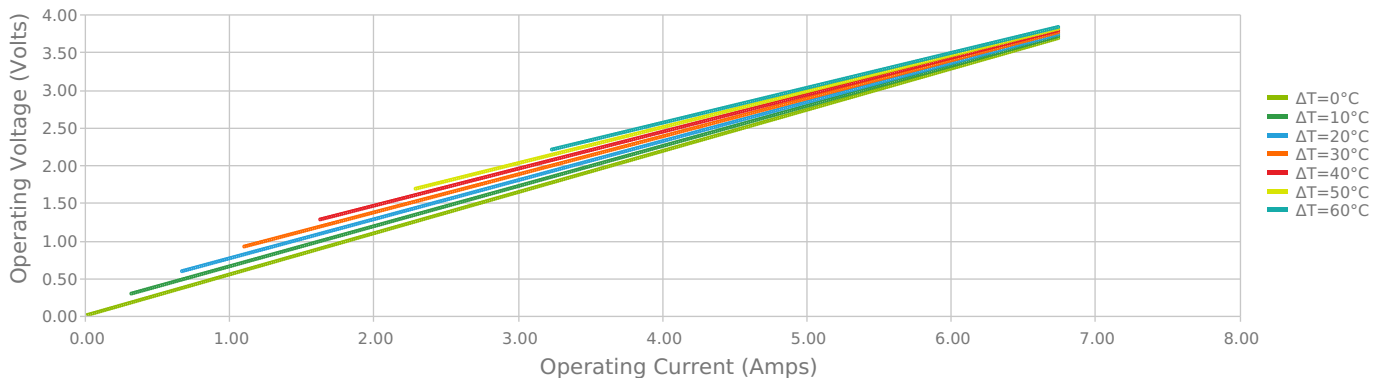

Coefficient of Performance (COP = Qc/Pin)
 Thot = 27 °C

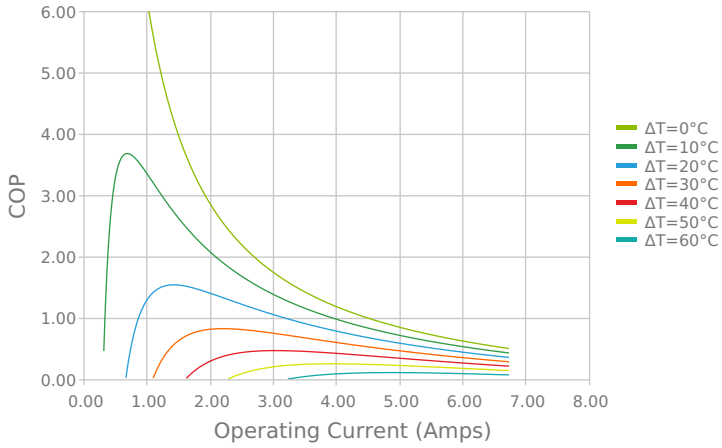

Coefficient of Performance (COP = Qc/Pin)
 Thot = 27 °C

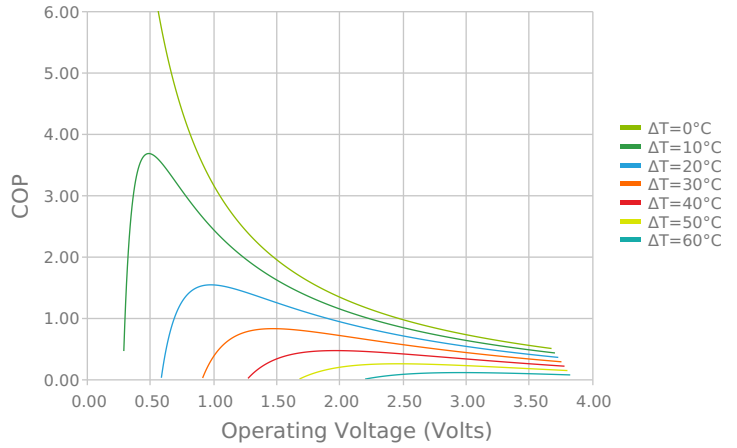

Total Heat Dissipated at Hot Side (Qh=Qc+Pin)
 Thot = 27 °C

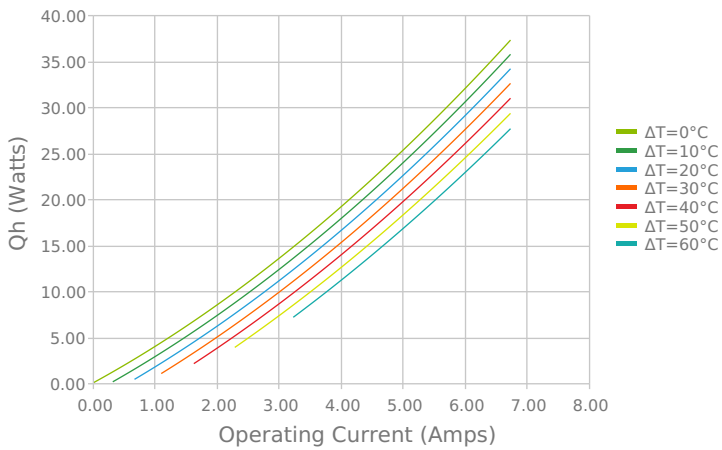

Total Heat Dissipated at Hot Side (Qh=Qc+Pin)
 Thot = 27 °C

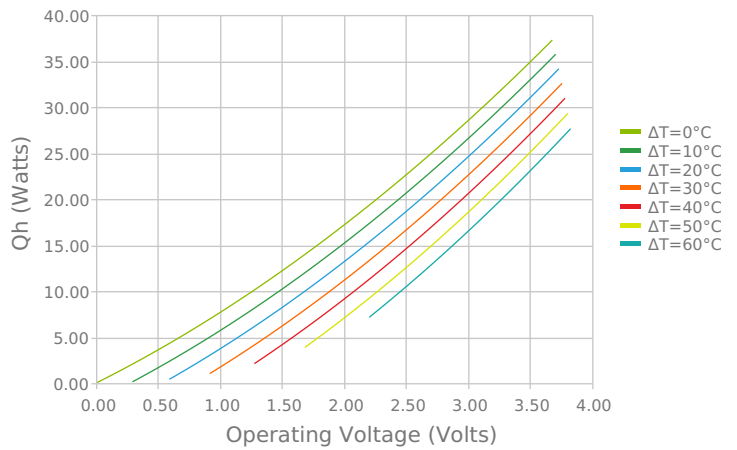

Heat Pumped at Cold Side (Qc)
 Thot = 27 °C | Current = 5.1 Amps

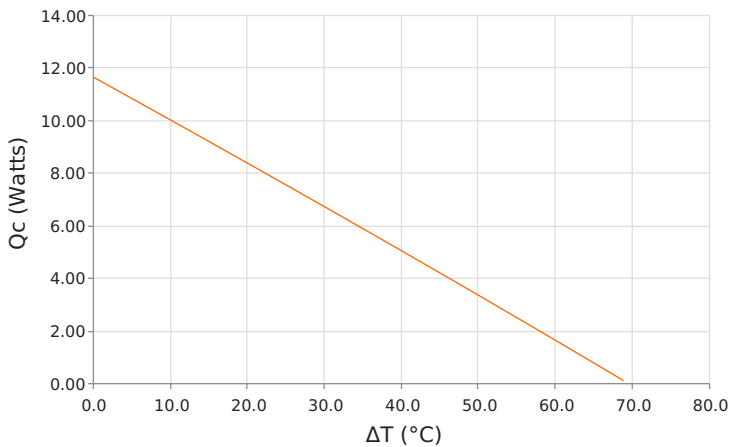

Coefficient of Performance (COP = Qc/Pin)
 Thot = 27 °C | Current = 5.1 Amps

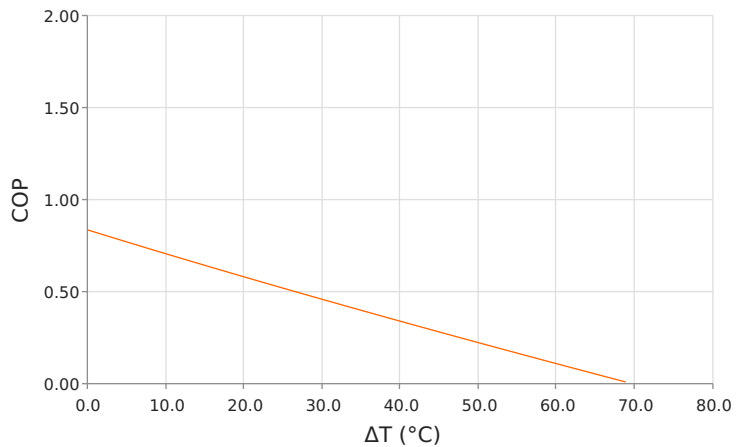

SPECIFICATIONS*

Hot Side Temperature	27.0 °C	35.0 °C	50.0 °C
Qcmax ($\Delta T = 0$)	12.4 Watts	12.8 Watts	13.5 Watts
ΔT_{max} ($Q_c = 0$)	70.5°C	73.5°C	78.8°C
I_{max} (I @ ΔT_{max})	6.0 Amps	5.9 Amps	5.9 Amps
V_{max} (V @ ΔT_{max})	3.5 Volts	3.6 Volts	3.9 Volts
Module Resistance	0.55 Ohms	0.57 Ohms	0.61 Ohms
Max Operating Temperature	80 °C		
Weight	20.0 gram(s)		

* Specifications reflect thermoelectric coefficients updated March 2020

FINISHING OPTIONS

Suffix	Thickness	Flatness / Parallelism	Hot Face	Cold Face	Lead Length
L1	3.810 ±0.025 mm 0.150 ± 0.0010 in	0.025 mm / 0.025 mm 0.001 in / 0.001 in	Lapped	Lapped	114.3 mm 4.50 in

SEALING OPTIONS

Suffix	Sealant	Color	Temp Range	Description
	None			No sealing specified

NOTES

1. Max operating temperature: 80°C
2. Do not exceed I_{max} or V_{max} when operating module
3. Reference assembly guidelines for recommended installation
4. Solder tinning also available on metallized ceramics

Any information furnished by Laird and its agents, whether in specifications, data sheets, product catalogues or otherwise, is believed to be (but is not warranted as being) accurate and reliable, is provided for information only and does not form part of any contract with Laird. All specifications are subject to change without notice. Laird assumes no responsibility and disclaims all liability for losses or damages resulting from use of or reliance on this information. All Laird products are sold subject to the Laird Terms and Conditions of sale (including Laird's limited warranty) in effect from time to time, a copy of which will be furnished upon request.

© Copyright 2019-2022 Laird Thermal Systems, Inc. All rights reserved. Laird™, the Laird Ring Logo, and Laird Thermal Systems™ are trademarks or registered trademarks of Laird Limited or its subsidiaries.

Revision: 00 Date: 06-01-2022

Print Date: 06-13-2022