

**S10F1C-P04MFG0-4000**  
**series\_f, type\_s1**

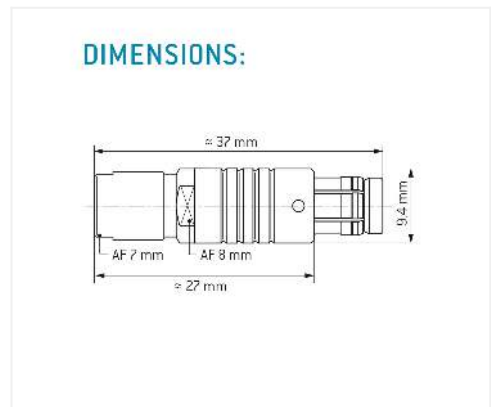

**General information**

<b>Part number</b>	S10F1C-P04MFG0-4000
<b>Termination</b>	solder
<b>Size</b>	0
<b>Locking principle</b>	push
<b>Coding</b>	1_halfshell
<b>Cable Diameter</b>	cable_mini_40
<b>Cable outlet</b>	standard

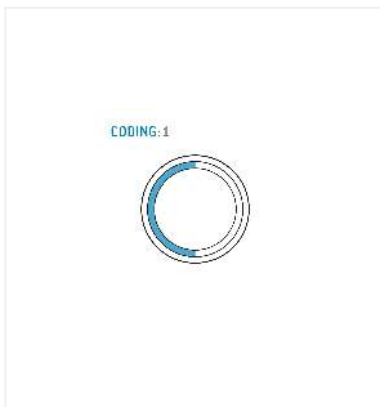

**Contact insert description**

<b>Number of contacts</b>	4
<b>Contact type</b>	pins
<b>Contact diameter</b>	07mm
<b>Insulator material</b>	peek
<b>Wire cross section</b>	22_awg
<b>Termination</b>	solder
<b>Termination diameter</b>	085mm

reverse\_gender\_on\_request

**Technical information**

<b>Max. creepage and air clearance distance</b>	06_mm	07_mm
<b>Nominal current single contact</b>	075_a	iec_60512_5_2
<b>Nominal current insert</b>	7,5 A	vde_0298_4
<b>Test voltage</b>	09_kv_ac	sae_13441

safety\_text

## Mechanical and environmental data

Degree of protection*	ip50
-----------------------	------

Operating temperature	40_120_c
-----------------------	----------

Mating cycles	5000
---------------	------

mated\_unmated

## Material and surface treatments

Housing	m_chrome
---------	----------

Contact	cu_alloy_gold
---------	---------------

safety\_text\_2

ul\_text

illustrative\_text