

Balun transformers
Wound SMD
ATB series



ATB3225 type



FEATURES

- The ATB3225 case size is L3.2×W2.5×H2.3mm.
- The case size is smaller than conventional Baluns.
- The frequency band width for ATB3225-75011CT is 5 to 200MHz, for ATB3225-75032CT is 5 to 100MHz, for ATB3225-75034CT is 1 to 100MHz, and for ATB3225-50011CT is 1 to 100MHz.
- Low insertion loss and good balance parameters.

APPLICATION

- Cable modem

PART NUMBER CONSTRUCTION

| | | | | | | | | |
|-------------|--------------------------------------|---|-------------------------|----------------------------------|-----------------|---|-----------------|---------------|
| ATB | 3225 | - | 750 | 11 | CT | - | T | 001 |
| Series name | LxWxH dimensions (mm) 3.2x2.5x2.3 | | Impedance (Ω) at 100MHz | Impedance ratio | Type | | Packaging style | Internal code |
| | | | 750 75 500 50 | 11 1:1 32 3:2 34 3:4 | CT Center tap | | T ø180mm reel | |

CHARACTERISTICS SPECIFICATION TABLE

| DC resistance (Ω)max. | Impedance ratio | Frequency range (MHz) | Insertion loss (dB)max. | Return loss (dB)min. | Amplitude unbalance (dB)max. | Phase difference (deg.) | Part No. |
|-----------------------|-----------------|-----------------------|-------------------------|----------------------|------------------------------|-------------------------|--------------------------------------|
| 0.7 | 1:1 (75Ω:75Ω) | 5 to 65 5 to 200 | 0.8 1.5 | 15 10 | 0.1 0.5 | 180±2 180±5 | ATB3225-75011CT-T001 |
| 0.7 | 3:2 (75Ω:50Ω) | 5 to 100 | 2 | 5 | 1 | 180±10 | ATB3225-75032CT-T001 |
| 0.7 | 3:4 (75Ω:100Ω) | 1 to 100 | 2 | 5 | 0.1 | 180±10 | ATB3225-75034CT-T000 |
| 0.7 | 1:1(50Ω: 50Ω) | 1 100 | 0.8 1.5 | 15 10 | 0.1 0.5 | 180±2 180±5 | ATB3225-50011CT-T000 |

* Temperature derating was considered for the rated current.

Measurement equipment

| Measurement item | Product No. | Manufacturer |
|---------------------|-------------|-----------------------|
| Insertion loss | E5071B | Keysight Technologies |
| Return loss | E5071B | Keysight Technologies |
| Amplitude unbalance | E5071B | Keysight Technologies |
| Phase difference | E5071B | Keysight Technologies |

* Equivalent measurement equipment may be used.



ATB3225 type

FREQUENCY CHARACTERISTICS

ATB3225-75011CT-T001

INSERTION LOSS

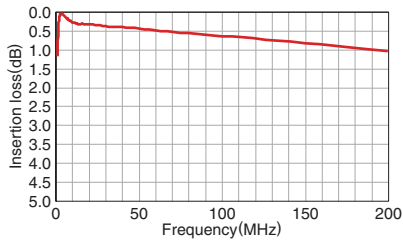

RETURN LOSS

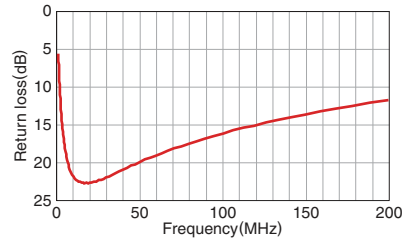

AMPLITUDE UNBALANCE

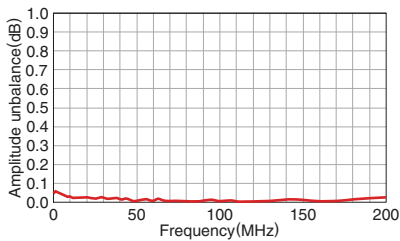

PHASE UNBALANCE

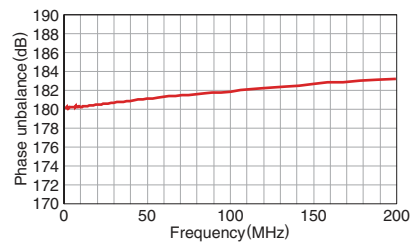

ATB3225-75032CT-T001

INSERTION LOSS

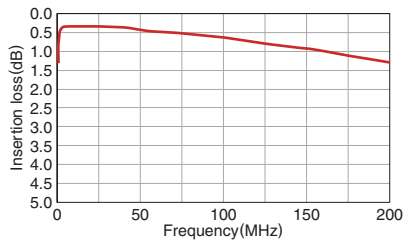

RETURN LOSS

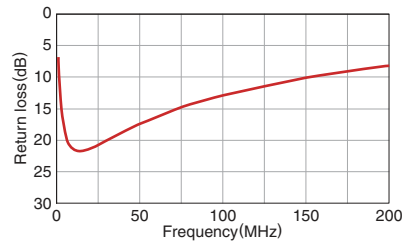

AMPLITUDE BALANCE

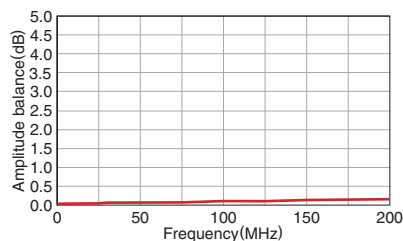

PHASE BALANCE

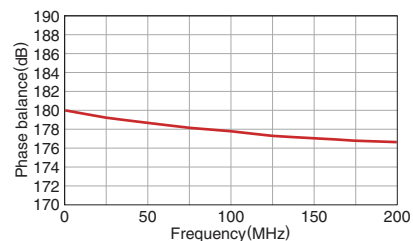

ATB3225 type

FREQUENCY CHARACTERISTICS

ATB3225-75034CT-T000

INSERTION LOSS

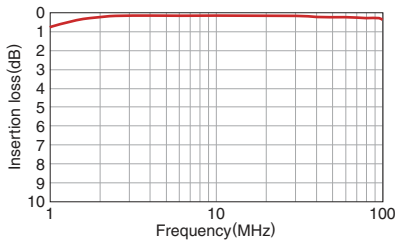

RETURN LOSS

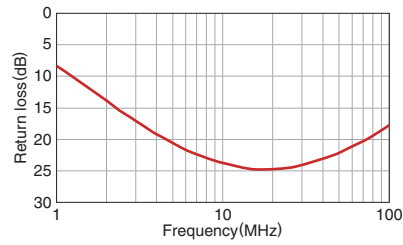

AMPLITUDE IMBALANCE

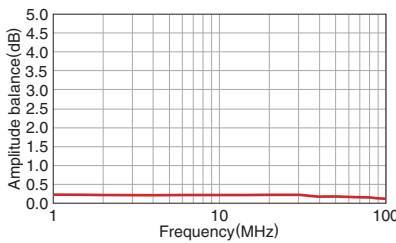

PHASE BALANCE

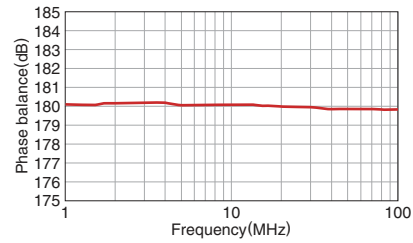

ATB3225-50011CT-T000

INSERTION LOSS

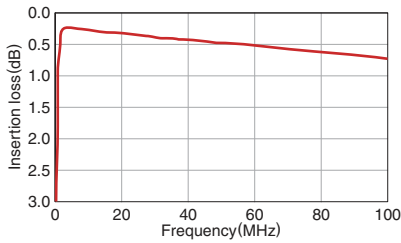

RETURN LOSS

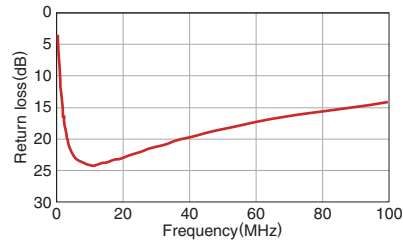

AMPLITUDE IMBALANCE

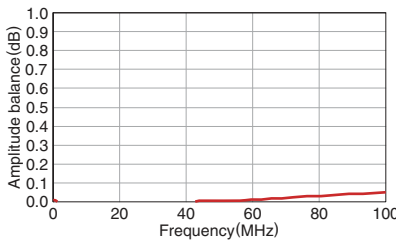

PHASE BALANCE

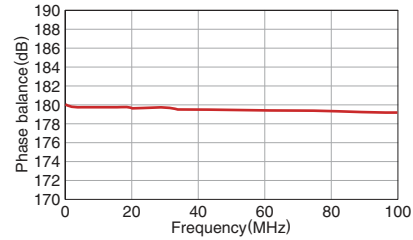

ATB3225 type

SHAPE & DIMENSIONS

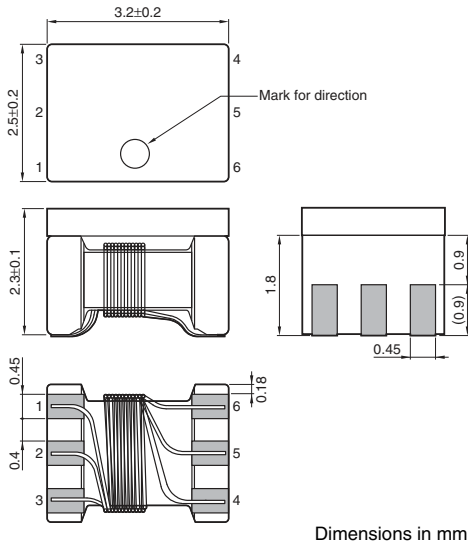

RECOMMENDED LAND PATTERN

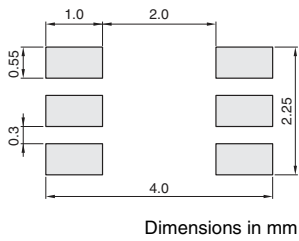

CIRCUIT DIAGRAM

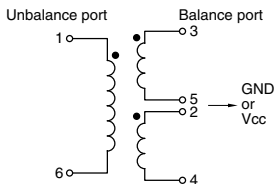

RECOMMENDED REFLOW PROFILE

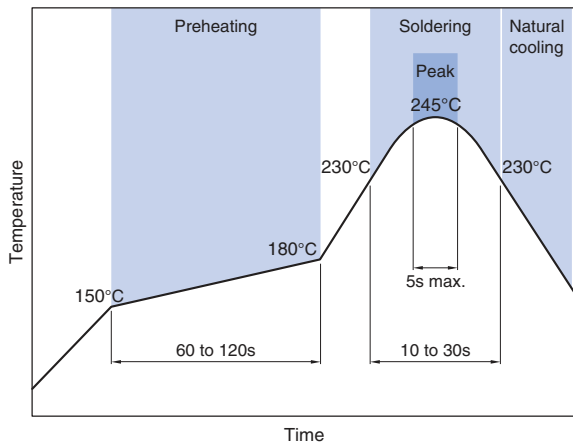

PACKAGING STYLE

REEL DIMENSIONS

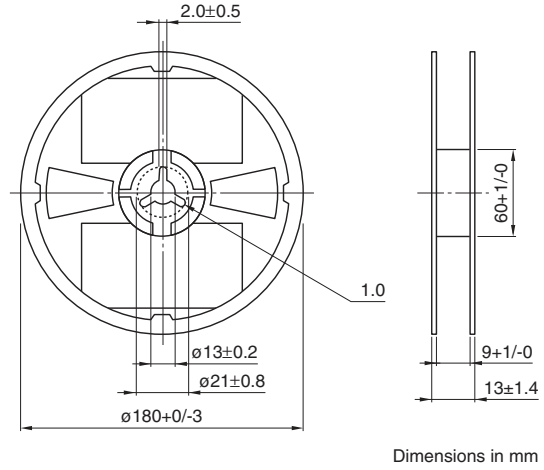

TAPE DIMENSIONS

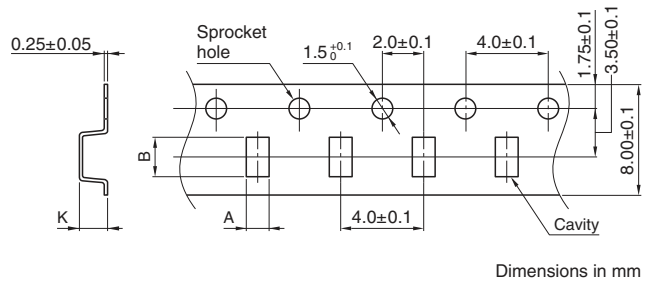

| Type | A | B | K |
|---------|----------|----------|----------|
| ATB3225 | 2.90±0.1 | 3.60±0.1 | 2.5±0.05 |

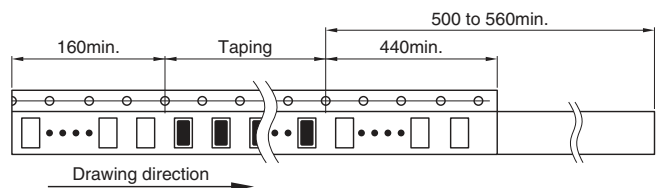

PACKAGE QUANTITY

| | |
|------------------|---------------|
| Package quantity | 1000 pcs/reel |
|------------------|---------------|

TEMPERATURE RANGE, INDIVIDUAL WEIGHT

| Operating temperature range | Storage temperature range* | Individual weight |
|-----------------------------|----------------------------|-------------------|
| -40 to +85°C | -40 to +85°C | 75 mg |

* The storage temperature range is for after the assembly.

REMINDERS FOR USING THESE PRODUCTS

Before using these products, be sure to request the delivery specifications.

SAFETY REMINDERS

Please pay sufficient attention to the warnings for safe designing when using this products.

REMINDERS

- The storage period is within 6 months. Be sure to follow the storage conditions (temperature: 5 to 40°C, humidity: 10 to 75% RH or less).
If the storage period elapses, the soldering of the terminal electrodes may deteriorate.
- Do not use or store in locations where there are conditions such as gas corrosion (salt, acid, alkali, etc.).
- Before soldering, be sure to preheat components.
The preheating temperature should be set so that the temperature difference between the solder temperature and chip temperature does not exceed 150°C.
- Soldering corrections after mounting should be within the range of the conditions determined in the specifications.
If overheated, a short circuit, performance deterioration, or lifespan shortening may occur.
- When embedding a printed circuit board where a chip is mounted to a set, be sure that residual stress is not given to the chip due to the overall distortion of the printed circuit board and partial distortion such as at screw tightening portions.
- Self heating (temperature increase) occurs when the power is turned ON, so the tolerance should be sufficient for the set thermal design.
- Carefully lay out the coil for the circuit board design of the non-magnetic shield type.
A malfunction may occur due to magnetic interference.
- Use a wrist band to discharge static electricity in your body through the grounding wire.
- Do not expose the products to magnets or magnetic fields.
- Do not use for a purpose outside of the contents regulated in the delivery specifications.
- The products listed on this catalog are intended for use in general electronic equipment (AV equipment, telecommunications equipment, home appliances, amusement equipment, computer equipment, personal equipment, office equipment, measurement equipment, industrial robots) under a normal operation and use condition.
The products are not designed or warranted to meet the requirements of the applications listed below, whose performance and/or quality require a more stringent level of safety or reliability, or whose failure, malfunction or trouble could cause serious damage to society, person or property.
If you intend to use the products in the applications listed below or if you have special requirements exceeding the range or conditions set forth in the each catalog, please contact us.

- (1) Aerospace/aviation equipment
- (2) Transportation equipment (cars, electric trains, ships, etc.)
- (3) Medical equipment
- (4) Power-generation control equipment
- (5) Atomic energy-related equipment
- (6) Seabed equipment
- (7) Transportation control equipment

- (8) Public information-processing equipment
- (9) Military equipment
- (10) Electric heating apparatus, burning equipment
- (11) Disaster prevention/crime prevention equipment
- (12) Safety equipment
- (13) Other applications that are not considered general-purpose applications

When designing your equipment even for general-purpose applications, you are kindly requested to take into consideration securing protection circuit/device or providing backup circuits in your equipment.