



10W Wall Mount Adapter - UK



Features

- Fixed Blade AC Input
- Ecodesign/ErP Lot 7 (EU) 2019/1782 Compliance
- CoC Version 5 Tier 2 Compliance
- Limited Power Source
- Class B EMI
- AA10K-050A(M)-R charging scheme: Data Lines (Pins 2 and 3) Shorted

Applications

- MPEG Players
- Personal Electronics
- PDAs
- Digital Cameras



AA10K Specifications¹

Model		AA10K-050A-R	AA10K-050A(M)-R ⁴
Output	DC Output Voltage	5.0V	
	Max Current	2.0A	
	Output Power	10.0W	
	Regulation	± 1% Line	
	Ripple & Noise P-P(max) ²	200mV	
Input	AC Input Voltage Range	90 to 264VAC	
	AC Input Frequency	47 to 63Hz	
	Input Current	0.3A(RMS) max @115VAC/60Hz	
	No Load Power Consumption at 115VAC Input	0.0386W	
	No Load Power Consumption at 230VAC Input	0.059W	
	115VAC Average Efficiency ³	81.70%	
	230VAC Average Efficiency ³	81.10%	
	230VAC 10% Load Efficiency ³	78.5%	
Protection	Leakage Current	20uA max @254VAC/50Hz	
	Over-Voltage	9.0V max	
	Short Circuit	The output can be shorted without damage	
Environmental	Over-Current	2.2A max	
	Operating Temperature	0°C to +40°C	
	Non-Operating Temperature	-20° to +85°C	
Safety Approvals and EMC	Operating Humidity	85% Relative Humidity	
	Dielectric Withstand (HI-POT)	Primary to Secondary: 3000VAC for 1min, 10mA	
	Insulation Resistance	Primary to Secondary: 10M ohm for 500VDC	
	Standards	IEC 62368-1	
	EMI Emissions	EN 55032/CISPR 32 Class B Conducted and Radiated	
	Harmonic Current Emissions	IEC 61000-3-2	
	Voltage Fluctuations & Flicker	IEC 61000-3-3	
Mechanical	Immunity	EN 55024/CISPR 24, EN 55035/CISPR 35: IEC 61000-4-2 (+/- 8kV air, +/- 4kV contact), IEC 61000-4-3, IEC 61000-4-4, IEC 61000-4-5 (+/- 1kV), IEC 61000-4-6, IEC 61000-4-8, IEC 61000-4-11	
	Dimensions (L x W x H)	71.2mm (2.80in) x 49.1mm (1.93in) x 77.9mm (3.07in)	
	Weight	75.5g	
	Cable Length	1500mm	
	DC Cable Type	22 AWG	
Notes	DC Output Connector	2.1mm x 5.5mm x 9.5mm	USB Micro-B
	<ol style="list-style-type: none"> The specifications defined are at ambient temperature of 25°C, unless otherwise specified. 20MHz bandwidth frequency oscilloscope, add a 0.1µF multilayer Cap. and Low ESR Electrolytic Cap. (10µF) at output connector terminals (nominal line voltage, full load). Efficiency is measured after 30 minutes burn-in. The charging scheme: Data Lines (Pins 2 and 3) Shorted 		



AA10K-050A-R Outline Drawing

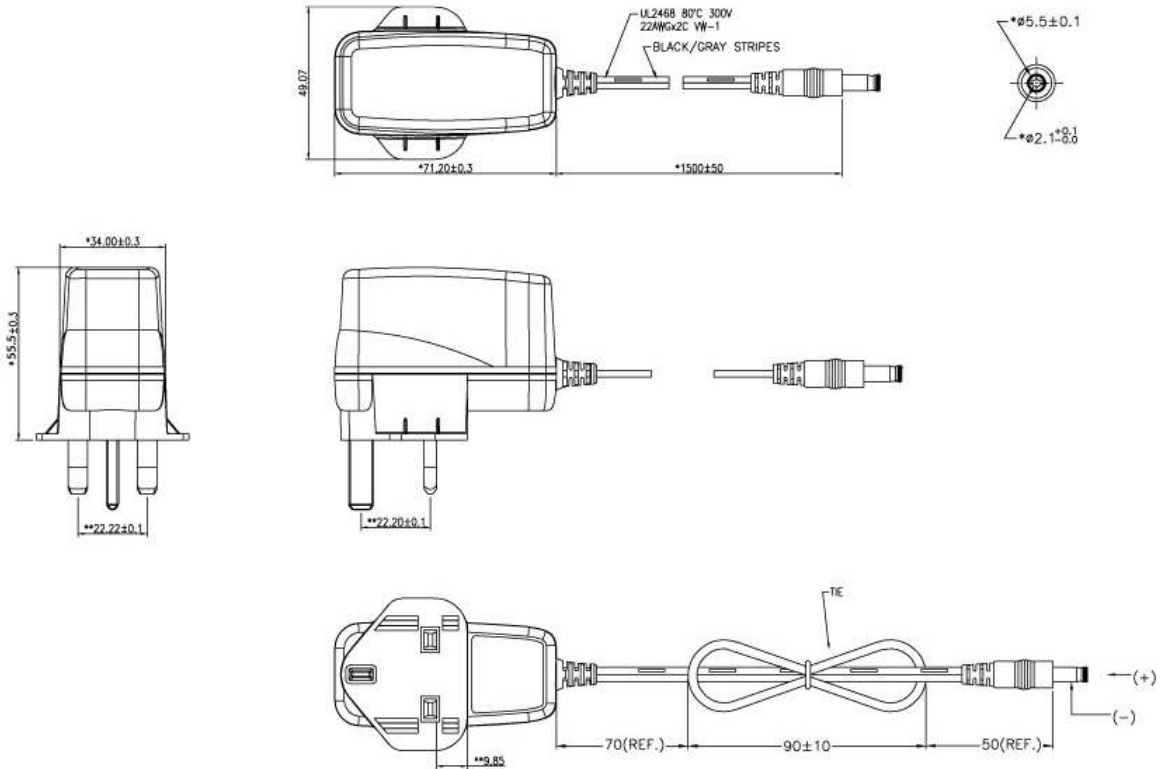



AA10K-050A(M)-R Outline Drawing

