

# QSB363 / QSB363GR / QSB363YR / QSB363ZR

## Subminiature Plastic Silicon Infrared Phototransistor

### Features

- NPN Silicon Phototransistor
- T-3/4 (2 mm) Surface Mount Package
- Medium Wide Beam Angle: 24°
- Black Plastic Package
- Matched Emitters: QEB363 or QEB373
- Daylight Filter
- Tape & Reel Option (see Tape & Reel Specifications)
- Lead Form Options: Gull-wing, Yoke, Z-Bend

### Description

The QSB363 is a silicon phototransistor encapsulated in a black infrared transparent T-3/4 package.

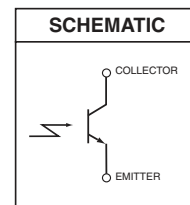
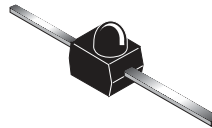

### Ordering Information

Part Number	Operating Temperature	Package	Packing Method
QSB363	-40 to +85°C	T-3/4	Bulk
QSB363GR		T-3/4 Gull-wing	Tape and Reel
QSB363YR		T-3/4 Yoke	Tape and Reel
QSB363ZR		T-3/4 Z-Bend	Tape and Reel

## Absolute Maximum Ratings

Stresses exceeding the absolute maximum ratings may damage the device. The device may not function or be operable above the recommended operating conditions and stressing the parts to these levels is not recommended. In addition, extended exposure to stresses above the recommended operating conditions may affect device reliability. The absolute maximum ratings are stress ratings only. Values are at  $T_A = 25^\circ\text{C}$  unless otherwise specified.

Symbol	Parameter	Min.	Unit
$T_{\text{OPR}}$	Operating Temperature	-40 to +85	°C
$T_{\text{STG}}$	Storage Temperature	-40 to +85	
$T_{\text{SOL-I}}$	Soldering Temperature (Iron) <sup>(1,2)</sup>	260	
$T_{\text{SOL-F}}$	Soldering Temperature (Flow) <sup>(1,2)</sup>	260	
$V_{\text{CEO}}$	Collector Emitter Voltage	30	
$V_{\text{ECO}}$	Emitter Collector Voltage	5	V
$P_C$	Power Dissipation <sup>(3)</sup>	75	mW

### Notes:

1. RMA flux is recommended.
2. Methanol or isopropyl alcohols are recommended as cleaning agents.
3. Derate power dissipation linearly 1.08 mW/°C above 25°C.

## Electrical / Optical Characteristics

Values are at  $T_A = 25^\circ\text{C}$  unless specified otherwise.

Symbol	Parameter	Test Conditions	Min.	Typ.	Max.	Units
$\lambda_p$	Peak Sensitivity Wavelength			940		nm
$\Theta$	Reception Angle			$\pm 12$		°
$I_{\text{CEO}}$	Collector Dark Current	$V_{\text{CE}} = 20 \text{ V}$ , $E_e = 0 \text{ mW/cm}^2$			100	nA
$BV_{\text{CEO}}$	Collector-Emitter Breakdown Voltage	$I_C = 100 \mu\text{A}$ , $E_e = 0 \text{ mW/cm}^2$	30			V
$BV_{\text{ECO}}$	Emitter-Collector Breakdown Voltage	$I_E = 100 \mu\text{A}$ , $E_e = 0 \text{ mW/cm}^2$	5			V
$I_{\text{C(ON)}}$	On-State Collector Current	$V_{\text{CE}} = 5 \text{ V}$ , $E_e = 1 \text{ mW/cm}^2$ , $\lambda = 940 \text{ nm GaAs}$	1.0	1.5		mA
$V_{\text{CE(SAT)}}$	Collector-Emitter Saturation Voltage	$I_C = 2 \text{ mA}$ , $E_e = 1 \text{ mW/cm}^2$ , $\lambda = 940 \text{ nm GaAs}$			0.4	V
$t_r$	Rise Time	$V_{\text{CE}} = 5 \text{ V}$ , $I_C = 1 \text{ mA}$ , $R_L = 1000 \Omega$		15		$\mu\text{s}$
$t_f$	Fall Time			15		$\mu\text{s}$

## Typical Performance Characteristics

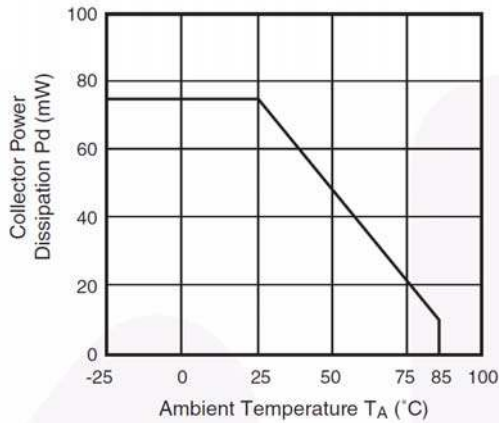

Figure 1. Collector Power Dissipation vs. Ambient Temperature

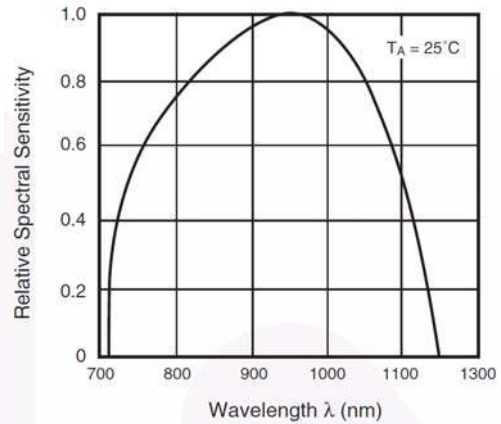

Figure 2. Spectral Sensitivity

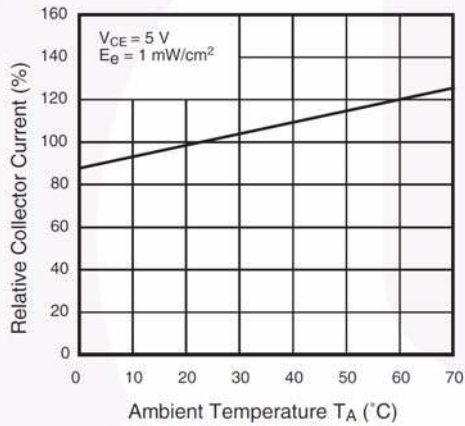

Figure 3. Relative Collector Current vs. Ambient Temperature

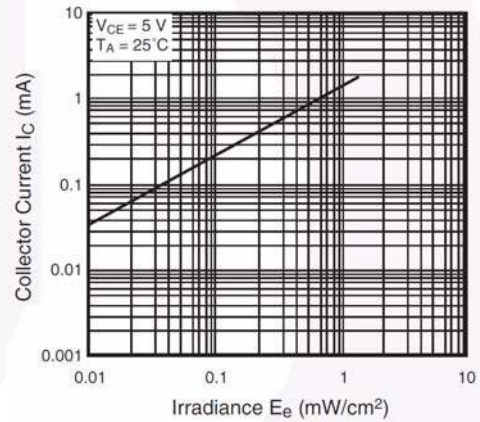

Figure 4. Collector Current vs. Irradiance

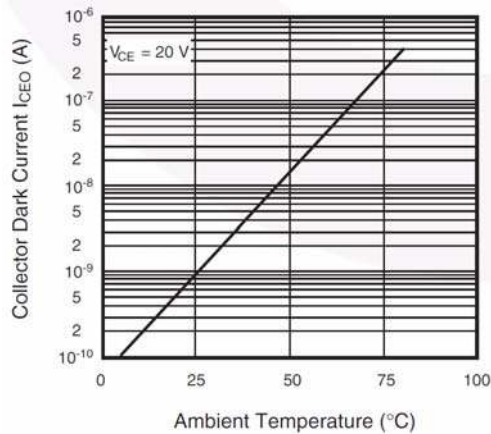

Figure 5. Collector Dark Current vs. Ambient Temperature

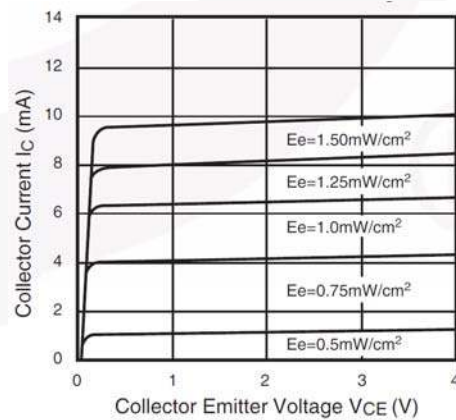
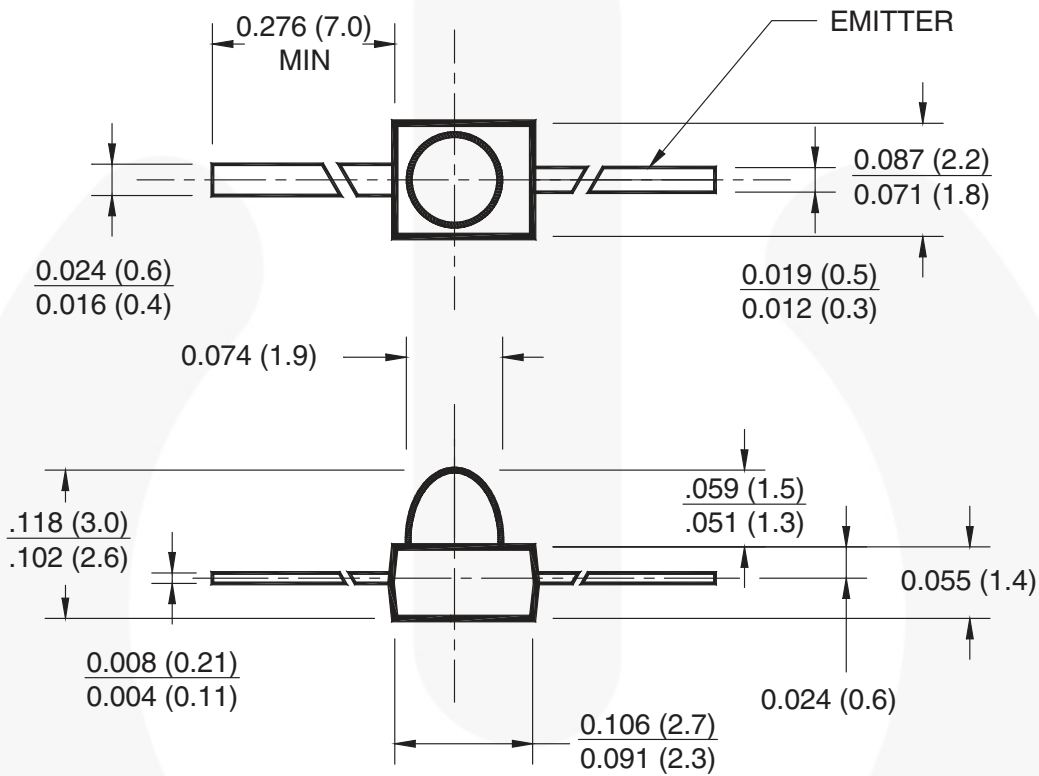

Figure 6. Collector Current vs. Collector Emitter Voltage

## Physical Dimensions

### T-3/4



**Notes:**

1. Dimensions for all drawings are in inches (mm).
2. Tolerance of  $\pm 0.010$  (0.25) on all non-nominal dimensions unless otherwise specified.

**Figure 7. T-3/4 ,2 MM DETECTOR (ACTIVE)**

Package drawings are provided as a service to customers considering Fairchild components. Drawings may change in any manner without notice. Please note the revision and/or date on the drawing and contact a Fairchild Semiconductor representative to verify or obtain the most recent revision. Package specifications do not expand the terms of Fairchild's worldwide terms and conditions, specifically the warranty therein, which covers Fairchild products.

Always visit Fairchild Semiconductor's online packaging area for the most recent package drawings:

<http://www.fairchildsemi.com/packaging/>

## Physical Dimensions (continued)

### Features

- Three lead forming options: Gull-wing, Yoke and Z-Bend
- Compatible with automatic placement equipment
- Supplied on tape and reel or in bulk packaging
- Compatible with vapor phase reflow solder processes

### Gull-wing Lead Configuration

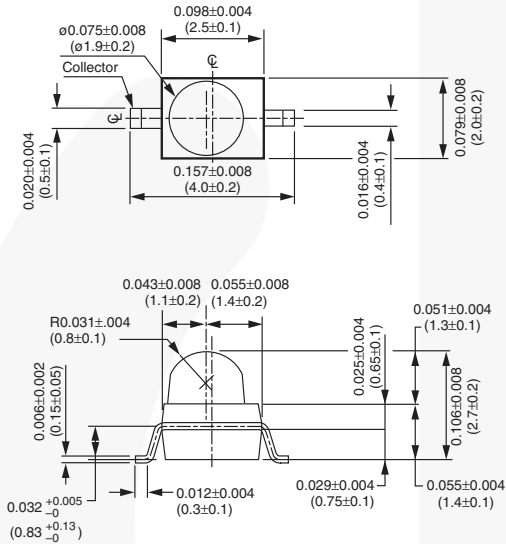

### Z-Bend Lead Configuration

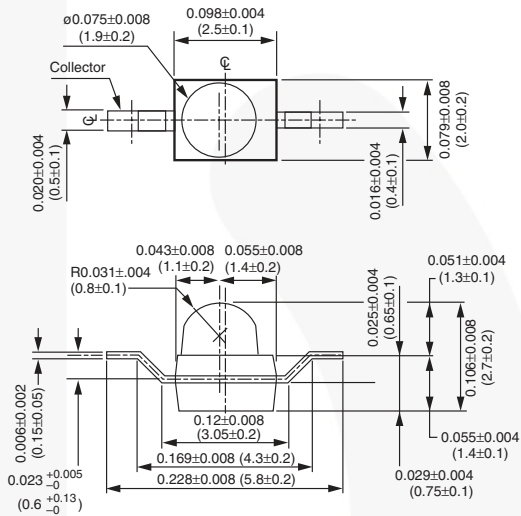



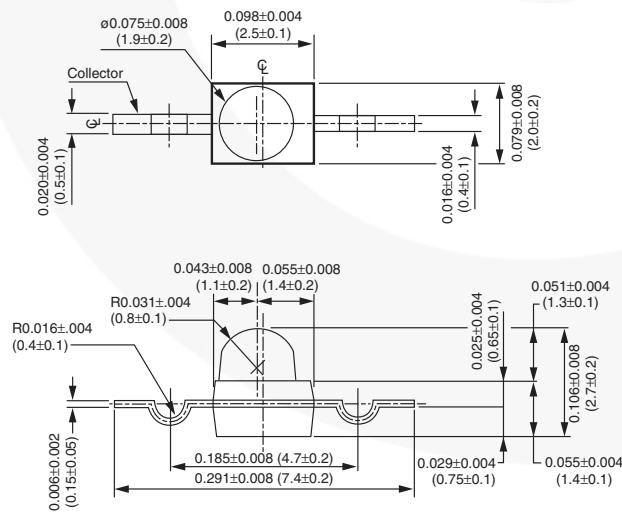

### Yoke Lead Configuration





**TRADEMARKS**

The following includes registered and unregistered trademarks and service marks, owned by Fairchild Semiconductor and/or its global subsidiaries, and is not intended to be an exhaustive list of all such trademarks.

2Cool™	FPS™		Sync-Lock™
AccuPower™	F-PFS™	PowerTrench®	
AX-CAP®*	FRFET®	PowerXS™	TinyBoost™
BitSiC™	Global Power Resource <sup>SM</sup>	Programmable Active Droop™	TinyBuck™
Build it Now™	GreenBridge™	QFET®	TinyCalc™
CorePLUS™	Green FPS™	QS™	TinyLogic®
CorePOWER™	Green FPS™ e-Series™	Quiet Series™	TINYOPTO™
CROSSVOLT™	Gmax™	RapidConfigure™	TinyPower™
CTL™	GTO™		TinyPWM™
Current Transfer Logic™	IntelliMAX™	Saving our world, 1mW/W/kW at a time™	TinyWire™
DEUXPEED®	ISOPLANAR™	SignalWise™	TranSiC™
Dual Cool™	Making Small Speakers Sound Louder and Better™	SmartMax™	TriFault Detect™
EcoSPARK®	MegaBuck™	SMART START™	TRUECURRENT®*
EfficientMax™	MICROCOUPLER™	Solutions for Your Success™	μSerDes™
ESBC™	MicroFET™	SPM®	
	MicroPak™	STEALTH™	UHC®
Fairchild®	MicroPak2™	SuperFET®	Ultra FRFET™
Fairchild Semiconductor®	MillerDrive™	SuperSOT™-3	UniFET™
FACT Quiet Series™	MotionMax™	SuperSOT™-6	VXC™
FACT®	mWSaver™	SuperSOT™-8	VisualMax™
FAST®	OptoHi™	SupreMOS®	VoltagePlus™
FastvCore™	OPTOLOGIC®	SyncFET™	XS™
FETBench™	OPTOPLANAR®		

\* Trademarks of System General Corporation, used under license by Fairchild Semiconductor.

**DISCLAIMER**

FAIRCHILD SEMICONDUCTOR RESERVES THE RIGHT TO MAKE CHANGES WITHOUT FURTHER NOTICE TO ANY PRODUCTS HEREIN TO IMPROVE RELIABILITY, FUNCTION, OR DESIGN. FAIRCHILD DOES NOT ASSUME ANY LIABILITY ARISING OUT OF THE APPLICATION OR USE OF ANY PRODUCT OR CIRCUIT DESCRIBED HEREIN; NEITHER DOES IT CONVEY ANY LICENSE UNDER ITS PATENT RIGHTS, NOR THE RIGHTS OF OTHERS. THESE SPECIFICATIONS DO NOT EXPAND THE TERMS OF FAIRCHILD'S WORLDWIDE TERMS AND CONDITIONS, SPECIFICALLY THE WARRANTY THEREIN, WHICH COVERS THESE PRODUCTS.

**LIFE SUPPORT POLICY**

FAIRCHILD'S PRODUCTS ARE NOT AUTHORIZED FOR USE AS CRITICAL COMPONENTS IN LIFE SUPPORT DEVICES OR SYSTEMS WITHOUT THE EXPRESS WRITTEN APPROVAL OF FAIRCHILD SEMICONDUCTOR CORPORATION.

As used herein:

1. Life support devices or systems are devices or systems which, (a) are intended for surgical implant into the body or (b) support or sustain life, and (c) whose failure to perform when properly used in accordance with instructions for use provided in the labeling, can be reasonably expected to result in a significant injury of the user.
2. A critical component in any component of a life support, device, or system whose failure to perform can be reasonably expected to cause the failure of the life support device or system, or to affect its safety or effectiveness.

**ANTI-COUNTERFEITING POLICY**

Fairchild Semiconductor Corporation's Anti-Counterfeiting Policy. Fairchild's Anti-Counterfeiting Policy is also stated on our external website, [www.fairchildsemi.com](http://www.fairchildsemi.com), under Sales Support.

Counterfeiting of semiconductor parts is a growing problem in the industry. All manufacturers of semiconductor products are experiencing counterfeiting of their parts. Customers who inadvertently purchase counterfeit parts experience many problems such as loss of brand reputation, substandard performance, failed applications, and increased cost of production and manufacturing delays. Fairchild is taking strong measures to protect ourselves and our customers from the proliferation of counterfeit parts. Fairchild strongly encourages customers to purchase Fairchild parts either directly from Fairchild or from Authorized Fairchild Distributors who are listed by country on our web page cited above. Products customers buy either from Fairchild directly or from Authorized Fairchild Distributors are genuine parts, have full traceability, meet Fairchild's quality standards for handling and storage and provide access to Fairchild's full range of up-to-date technical and product information. Fairchild and our Authorized Distributors will stand behind all warranties and will appropriately address any warranty issues that may arise. Fairchild will not provide any warranty coverage or other assistance for parts bought from Unauthorized Sources. Fairchild is committed to combat this global problem and encourage our customers to do their part in stopping this practice by buying direct or from authorized distributors.

**PRODUCT STATUS DEFINITIONS**

**Definition of Terms**

Datasheet Identification	Product Status	Definition
Advance Information	Formative / In Design	Datasheet contains the design specifications for product development. Specifications may change in any manner without notice.
Preliminary	First Production	Datasheet contains preliminary data; supplementary data will be published at a later date. Fairchild Semiconductor reserves the right to make changes at any time without notice to improve design.
No Identification Needed	Full Production	Datasheet contains final specifications. Fairchild Semiconductor reserves the right to make changes at any time without notice to improve the design.
Obsolete	Not In Production	Datasheet contains specifications on a product that is discontinued by Fairchild Semiconductor. The datasheet is for reference information only.