

# ON Semiconductor

## Is Now

# onsemi™

To learn more about onsemi™, please visit our website at  
[www.onsemi.com](http://www.onsemi.com)

---

**onsemi** and **onsemi** and other names, marks, and brands are registered and/or common law trademarks of Semiconductor Components Industries, LLC dba "**onsemi**" or its affiliates and/or subsidiaries in the United States and/or other countries. **onsemi** owns the rights to a number of patents, trademarks, copyrights, trade secrets, and other intellectual property. A listing of **onsemi** product/patent coverage may be accessed at [www.onsemi.com/site/pdf/Patent-Marking.pdf](http://www.onsemi.com/site/pdf/Patent-Marking.pdf). **onsemi** reserves the right to make changes at any time to any products or information herein, without notice. The information herein is provided "as-is" and **onsemi** makes no warranty, representation or guarantee regarding the accuracy of the information, product features, availability, functionality, or suitability of its products for any particular purpose, nor does **onsemi** assume any liability arising out of the application or use of any product or circuit, and specifically disclaims any and all liability, including without limitation special, consequential or incidental damages. Buyer is responsible for its products and applications using **onsemi** products, including compliance with all laws, regulations and safety requirements or standards, regardless of any support or applications information provided by **onsemi**. "Typical" parameters which may be provided in **onsemi** data sheets and/or specifications can and do vary in different applications and actual performance may vary over time. All operating parameters, including "Typicals" must be validated for each customer application by customer's technical experts. **onsemi** does not convey any license under any of its intellectual property rights nor the rights of others. **onsemi** products are not designed, intended, or authorized for use as a critical component in life support systems or any FDA Class 3 medical devices or medical devices with a same or similar classification in a foreign jurisdiction or any devices intended for implantation in the human body. Should Buyer purchase or use **onsemi** products for any such unintended or unauthorized application, Buyer shall indemnify and hold **onsemi** and its officers, employees, subsidiaries, affiliates, and distributors harmless against all claims, costs, damages, and expenses, and reasonable attorney fees arising out of, directly or indirectly, any claim of personal injury or death associated with such unintended or unauthorized use, even if such claim alleges that **onsemi** was negligent regarding the design or manufacture of the part. **onsemi** is an Equal Opportunity/Affirmative Action Employer. This literature is subject to all applicable copyright laws and is not for resale in any manner. Other names and brands may be claimed as the property of others.

# NCP4686

## 400 mA, High Accuracy, Low Input Voltage, Low Dropout Regulator

The NCP4686 is CMOS Linear voltage regulators with 400 mA output current capability. The device has very high output voltage accuracy, low supply current and low ON-resistance transistor. The NCP4686 is easy to use and includes output current fold-back protection and a fully integrated constant slope circuit as a soft-start circuit. Due to its inrush current is minimized and no output voltage overshoots are there. A Chip Enable function is included to save power by lowering supply current.

### Features

- Operating Input Voltage Range: 1.0 V to 3.6 V
- Output Voltage Range: 0.7 V to 1.8 V (available in 0.1 V steps)
- Output Voltage Accuracy:  $\pm 0.8\%$  ( $V_{OUT} \geq 1.0$  V,  $T_A = 25^\circ\text{C}$ )
- Supply Current: 48  $\mu\text{A}$
- Dropout Voltage: 0.22 V ( $V_{OUT} = 1.5$  V)
- Line Regulation: 0.1%/V Typ.
- Ripple Rejection: Typ. 60 dB ( $f = 10$  kHz)
- Stable with Ceramic Capacitors: 1  $\mu\text{F}$  or more
- Current Fold Back Protection
- Build-in Constant Slope Circuit
- Available in XDFN6 1.2 x 1.2 mm, SC-70, SOT23 Packages
- These are Pb-Free Devices

### Typical Applications

- Battery-powered Equipment
- Networking and Communication Equipment
- Cameras, DVRs, STB and Camcorders
- Home Appliances

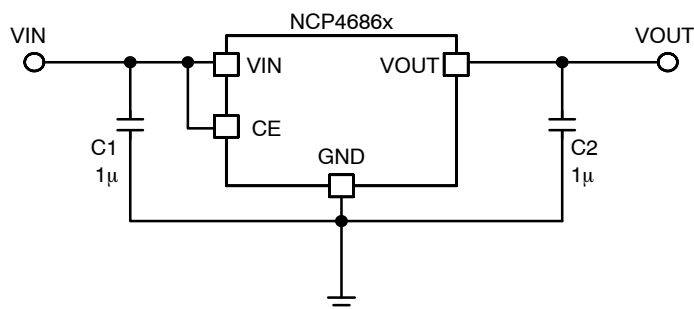

Figure 1. Typical Application Schematics



ON Semiconductor™

<http://onsemi.com>

### MARKING DIAGRAMS

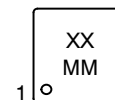
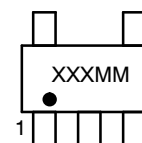
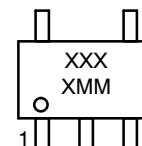

XX, XXX, XXXX = Specific Device Code  
M, MM = Date Code  
A = Assembly Location  
Y = Year  
W = Work Week  
▪ = Pb-Free Package

(\*Note: Microdot may be in either location)

### ORDERING INFORMATION

See detailed ordering and shipping information in the package dimensions section on page 14 of this data sheet.

# NCP4686

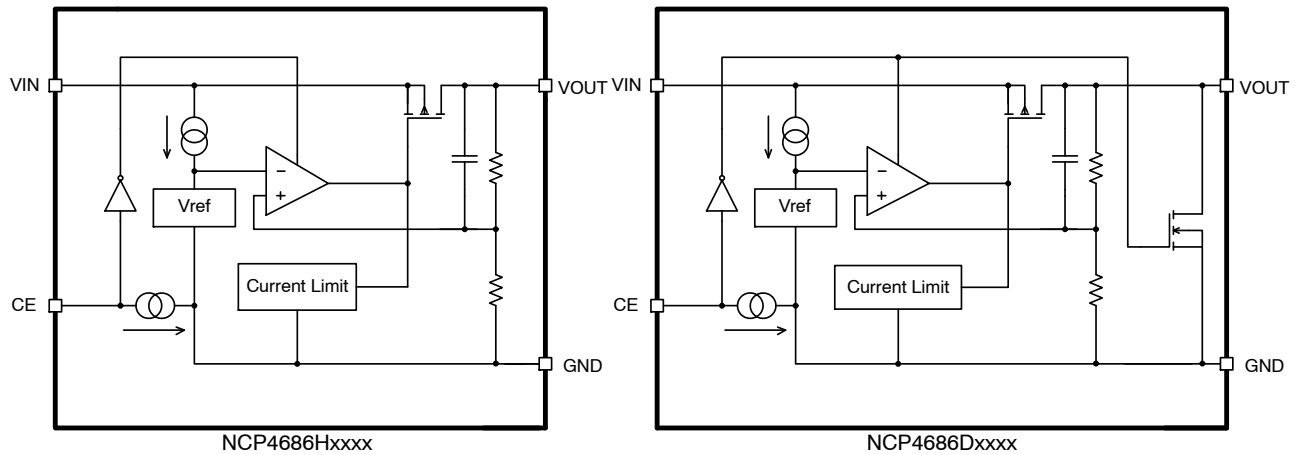

Figure 2. Simplified Schematic Block Diagram

## PIN FUNCTION DESCRIPTION

Pin No. XDFN6	Pin No. SC-70	Pin No. SOT23	Pin Name	Description
6	4	5	V <sub>OUT</sub>	Output pin
2	3	2	GND	Ground
3	1	3	CE	Chip enable pin (Active "H")
4	5	1	V <sub>IN</sub>	Input pin
1	2	4	NC	No connection
5	-	-	NC	No connection

\*Please refer to package dimensions section on Page 15 on this data sheet for pin numbers associated with different package.

## ABSOLUTE MAXIMUM RATINGS

Rating	Symbol	Value	Unit
Input Voltage (Note 1)	V <sub>IN</sub>	4.0	V
Output Voltage	V <sub>OUT</sub>	-0.3 to V <sub>IN</sub> + 0.3	V
Chip Enable Input	V <sub>CE</sub>	-0.3 to 4.0	V
Output Current	I <sub>OUT</sub>	500	mA
Power Dissipation XDFN1212	P <sub>D</sub>	400	mW
Power Dissipation SC-70		380	
Power Dissipation SOT23		420	
Junction Temperature	T <sub>J</sub>	-40 to 150	°C
Storage Temperature	T <sub>STG</sub>	-55 to 125	°C
Operating Ambient Temperature Range	T <sub>A</sub>	-40 to +85	°C
ESD Capability, Human Body Model (Note 2)	ESD <sub>HBM</sub>	2000	V
ESD Capability, Machine Model (Note 2)	ESD <sub>MM</sub>	200	V

Stresses exceeding Maximum Ratings may damage the device. Maximum Ratings are stress ratings only. Functional operation above the Recommended Operating Conditions is not implied. Extended exposure to stresses above the Recommended Operating Conditions may affect device reliability.

1. Refer to ELECTRICAL CHARACTERISTICS and APPLICATION INFORMATION for Safe Operating Area.
2. This device series incorporates ESD protection and is tested by the following methods:  
 ESD Human Body Model tested per AEC-Q100-002 (EIA/JESD22-A114)  
 ESD Machine Model tested per AEC-Q100-003 (EIA/JESD22-A115)  
 Latchup Current Maximum Rating tested per JEDEC standard: JESD78.

# NCP4686

## THERMAL CHARACTERISTICS

Rating	Symbol	Value	Unit
Thermal Characteristics, XDFN6 1.2 x 1.2 mm Thermal Resistance, Junction-to-Air	$R_{\theta JA}$	250	$^{\circ}\text{C}/\text{W}$
Thermal Characteristics, SOT23 Thermal Resistance, Junction-to-Air	$R_{\theta JA}$	238	$^{\circ}\text{C}/\text{W}$
Thermal Characteristics, SC-70 Thermal Resistance, Junction-to-Air	$R_{\theta JA}$	263	$^{\circ}\text{C}/\text{W}$

## ELECTRICAL CHARACTERISTICS

$-40^{\circ}\text{C} \leq T_A \leq 85^{\circ}\text{C}$ ;  $V_{IN} = V_{OUT(NOM)} + 1\text{ V}$ , whichever is greater;  $I_{OUT} = 1\text{ mA}$ ,  $C_{IN} = C_{OUT} = 0.1\text{ }\mu\text{F}$ , unless otherwise noted. Typical values are at  $T_A = +25^{\circ}\text{C}$ .

Parameter	Test Conditions	Symbol	Min	Typ	Max	Unit	
Operating Input Voltage		$V_{IN}$	1.0		3.6	V	
Output Voltage	$T_A = +25^{\circ}\text{C}$	$V_{OUT} \geq 1.0\text{ V}$	$\times 0.992$		$\times 1.008$	V	
		$V_{OUT} < 1.0\text{ V}$	-8		8	mV	
	$-40^{\circ}\text{C} \leq T_A \leq 85^{\circ}\text{C}$	$V_{OUT} \geq 1.0\text{ V}$	$\times 0.983$		$\times 1.017$	V	
		$V_{OUT} < 1.0\text{ V}$	-17		17	mV	
Output Voltage Temp. Coefficient	$-40^{\circ}\text{C} \leq T_A \leq 85^{\circ}\text{C}$	$\Delta V_{OUT} / \Delta T_A$		$\pm 60$		ppm/ $^{\circ}\text{C}$	
Line Regulation	$V_{OUT(NOM)} + 0.5\text{ V} \leq V_{IN} \leq 3.6\text{ V}$ , $V_{IN} \geq 1.3\text{ V}$	LineReg		0.10	0.25	%/V	
Load Regulation	$I_{OUT} = 1\text{ mA to } 400\text{ mA}$	LoadReg		25	45	mV	
Dropout Voltage	$I_{OUT} = 400\text{ mA}$	$0.7\text{ V} \leq V_{OUT} < 0.8\text{ V}$	$V_{DO}$		0.48	0.62	V
		$0.8\text{ V} \leq V_{OUT} < 0.9\text{ V}$			0.40	0.54	
		$0.9\text{ V} \leq V_{OUT} < 1.0\text{ V}$			0.36	0.47	
		$1.0\text{ V} \leq V_{OUT} < 1.2\text{ V}$			0.32	0.45	
		$1.2\text{ V} \leq V_{OUT} < 1.5\text{ V}$			0.28	0.38	
		$1.5\text{ V} \leq V_{OUT}$			0.22	0.31	
Output Current		$I_{OUT}$	400			mA	
Short Current Limit	$V_{OUT} = 0\text{ V}$	$I_{SC}$		110		mA	
Quiescent Current		$I_Q$		48	75	$\mu\text{A}$	
Standby Current	$V_{CE} = 0\text{ V}$ , $T_A = 25^{\circ}\text{C}$	$I_{STB}$		0.1	8.0	$\mu\text{A}$	
CE Pin Threshold Voltage	CE Input Voltage "H"	$V_{CEH}$	0.9			V	
	CE Input Voltage "L"	$V_{CEL}$			0.4		
Power Supply Rejection Ratio	$V_{IN} = V_{OUT} + 1.0\text{ V}$ , $\Delta V_{IN} = 0.2\text{ V}_{pk-pk}$ , $I_{OUT} = 30\text{ mA}$ , $f = 10\text{ kHz}$	PSRR		60		dB	
Output Noise Voltage	$f = 10\text{ Hz to } 100\text{ kHz}$ , $V_{OUT} = 0.7\text{ V}$ , $I_{OUT} = 30\text{ mA}$	$V_N$		30		$\mu\text{V}_{rms}$	
Low Output N-channel Tr. On Resistance	$V_{IN} = 2\text{ V}$ , $V_{CE} = 0\text{ V}$ , NCP4686D only	$R_{LOW}$		43		$\Omega$	

TYPICAL CHARACTERISTICS

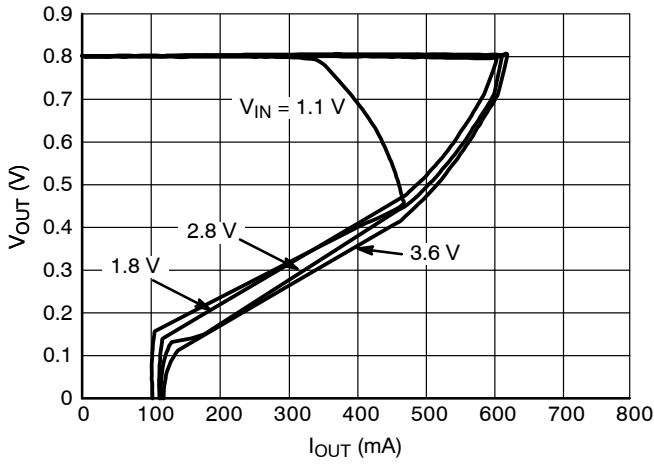

Figure 3. Output Voltage vs. Output Current  
0.8 V Version ( $T_J = 25^\circ\text{C}$ )

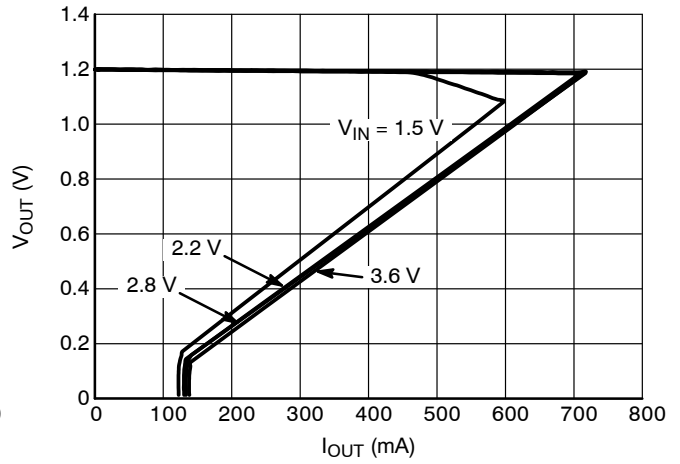

Figure 4. Output Voltage vs. Output Current  
1.2 V Version ( $T_J = 25^\circ\text{C}$ )

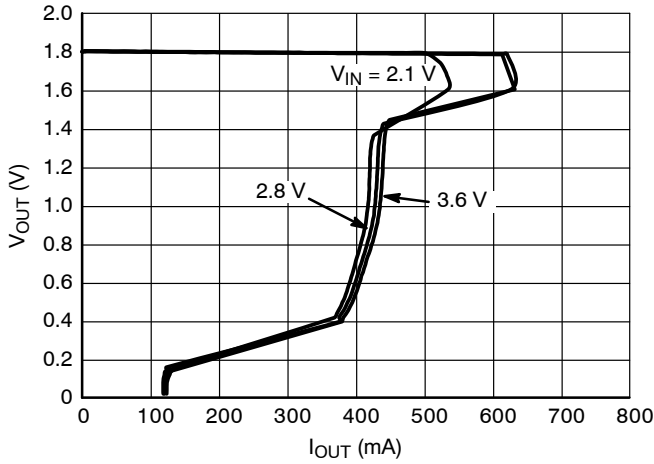

Figure 5. Output Voltage vs. Output Current  
1.8 V Version ( $T_J = 25^\circ\text{C}$ )

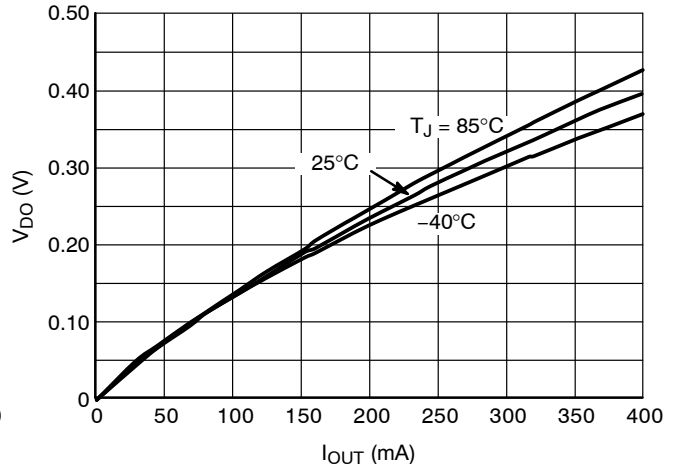

Figure 6. Dropout Voltage vs. Output Current  
0.8 V Version

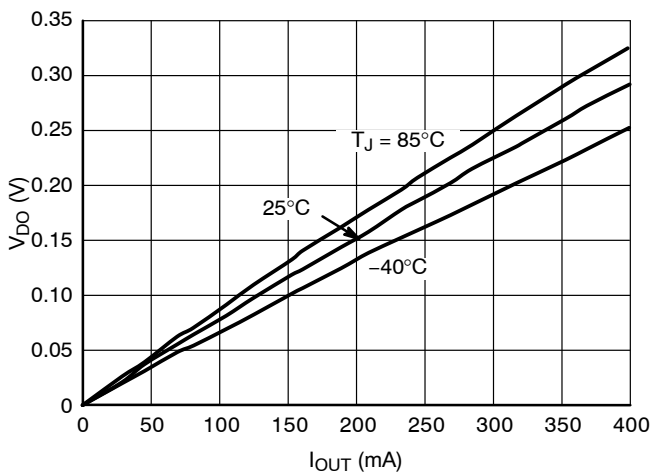

Figure 7. Dropout Voltage vs. Output Current  
1.2 V Version

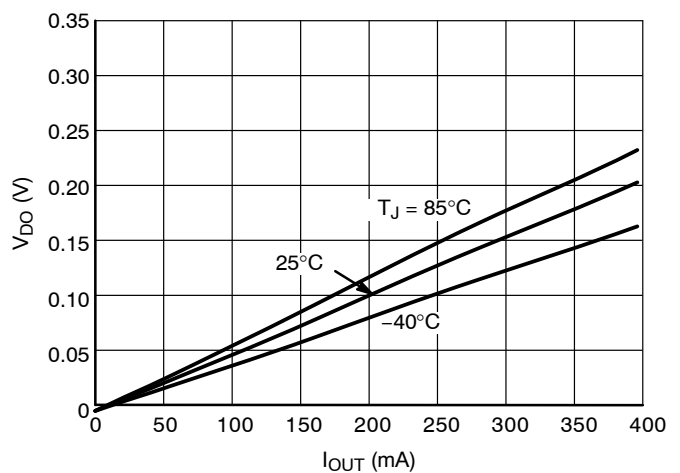

Figure 8. Dropout Voltage vs. Output Current  
1.8 V Version

TYPICAL CHARACTERISTICS

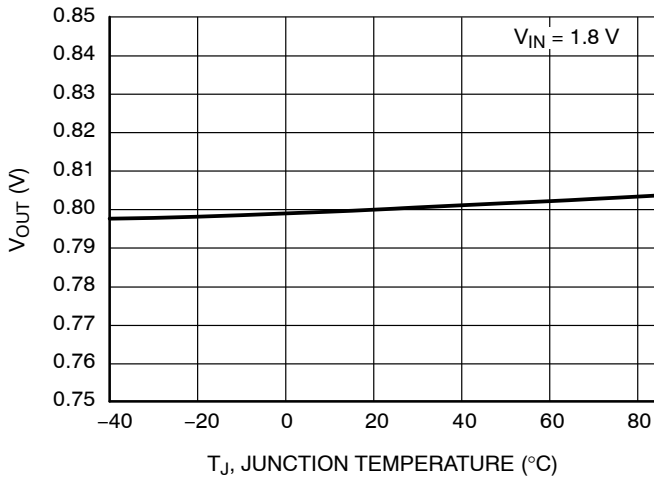

Figure 9. Output Voltage vs. Temperature, 0.8 V Version

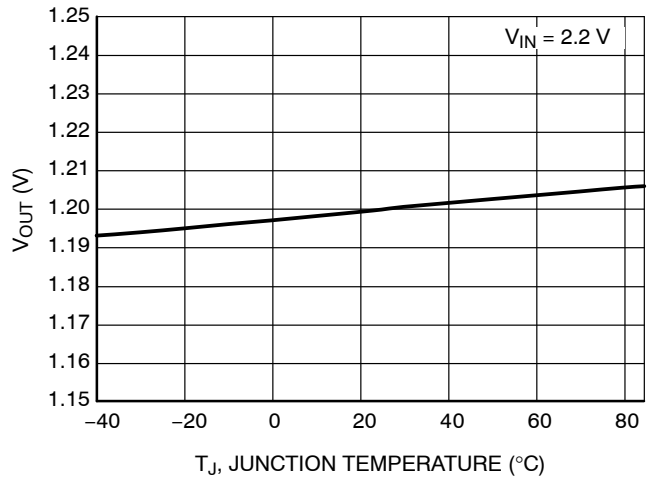

Figure 10. Output Voltage vs. Temperature, 1.2 V Version

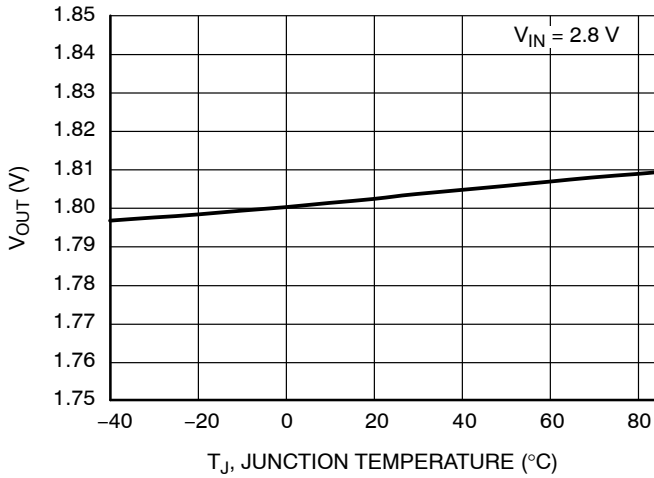

Figure 11. Output Voltage vs. Temperature, 2.8 V Version

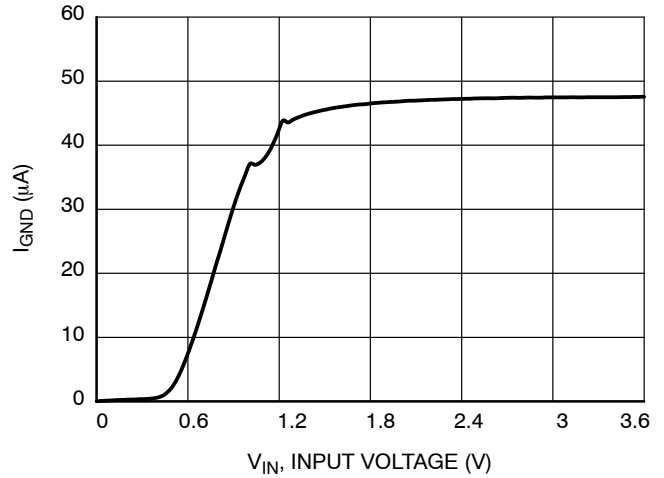

Figure 12. Supply Current vs. Input Voltage, 0.8 V Version

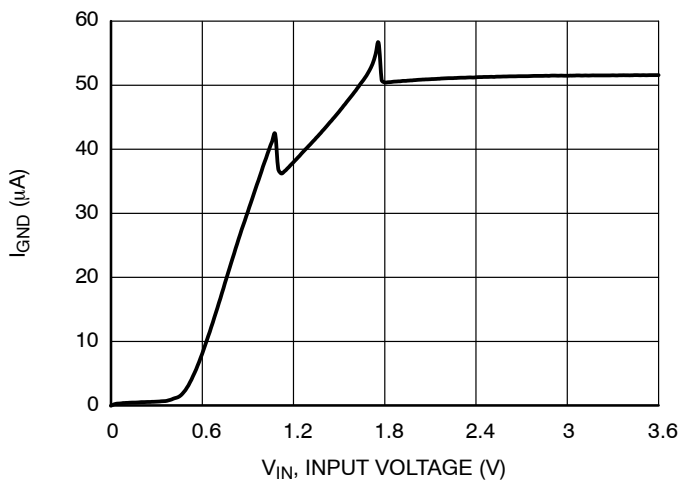

Figure 13. Supply Current vs. Input Voltage, 1.2 V Version

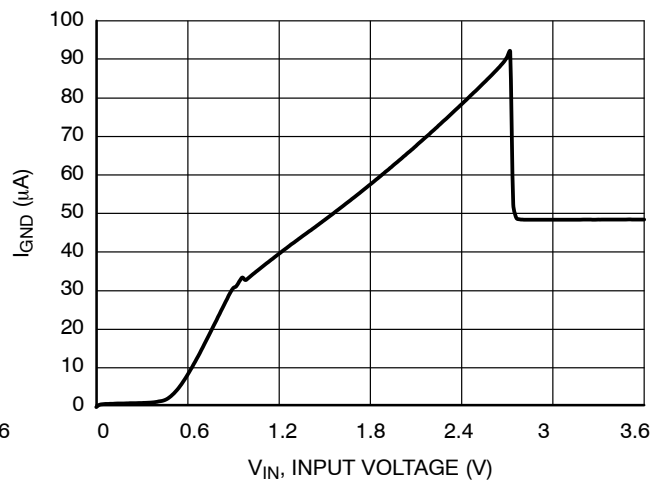
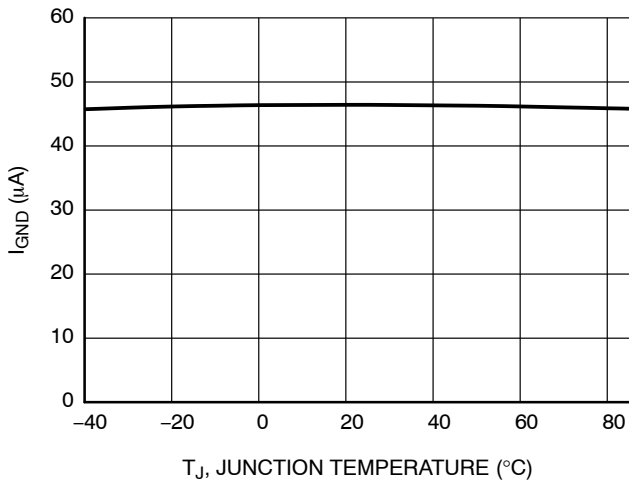

Figure 14. Supply Current vs. Input Voltage, 1.8 V Version

# NCP4686

## TYPICAL CHARACTERISTICS



**Figure 15. Supply Current vs. Temperature, 0.8 V Version**

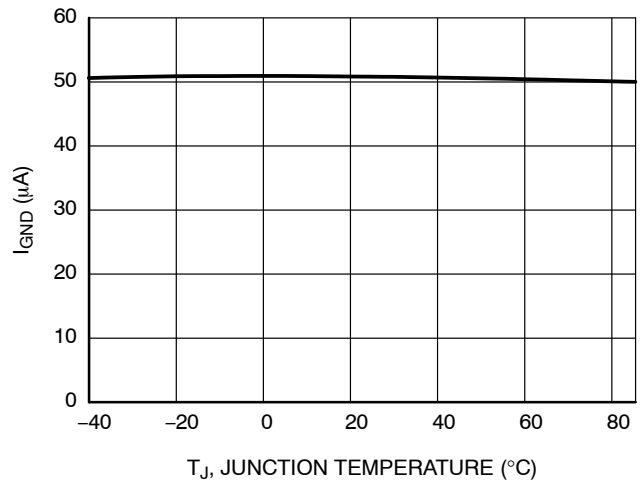

**Figure 16. Supply Current vs. Temperature, 1.2 V Version**

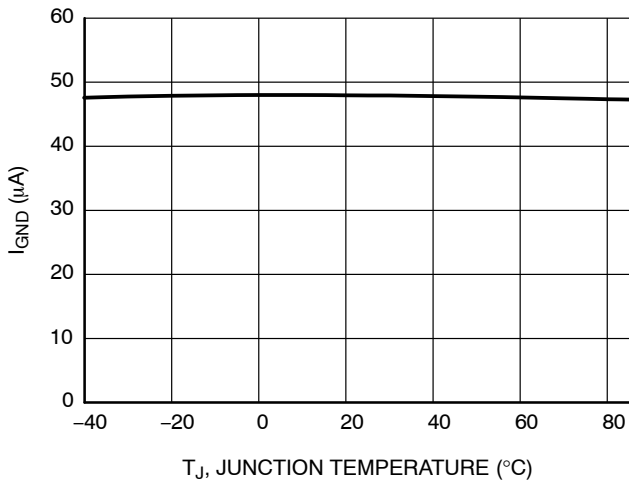

**Figure 17. Supply Current vs. Temperature, 1.8 V Version**

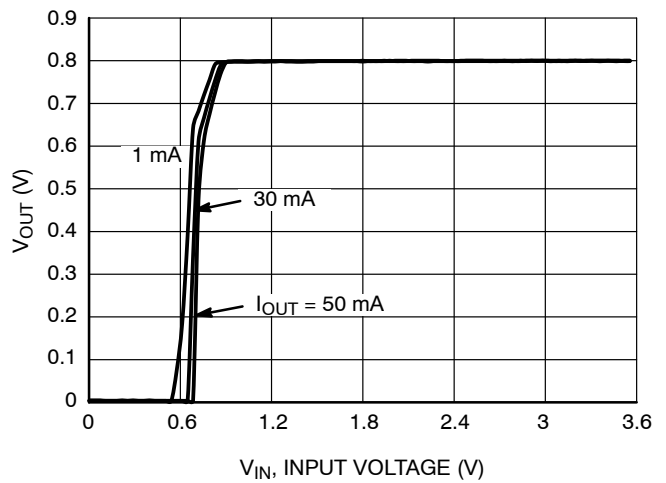

**Figure 18. Output Voltage vs. Input Voltage, 0.8 V Version**

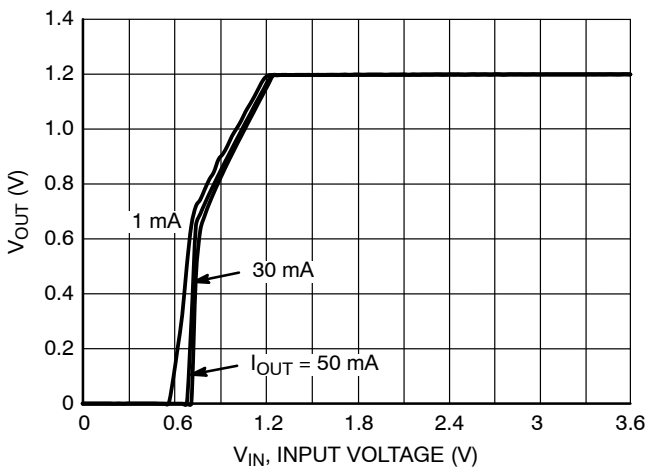

**Figure 19. Output Voltage vs. Input Voltage, 1.2 V Version**

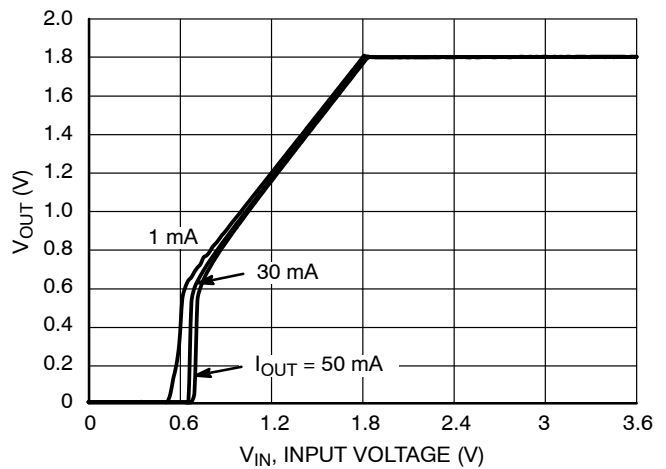

**Figure 20. Output Voltage vs. Input Voltage, 1.8 V Version**

TYPICAL CHARACTERISTICS

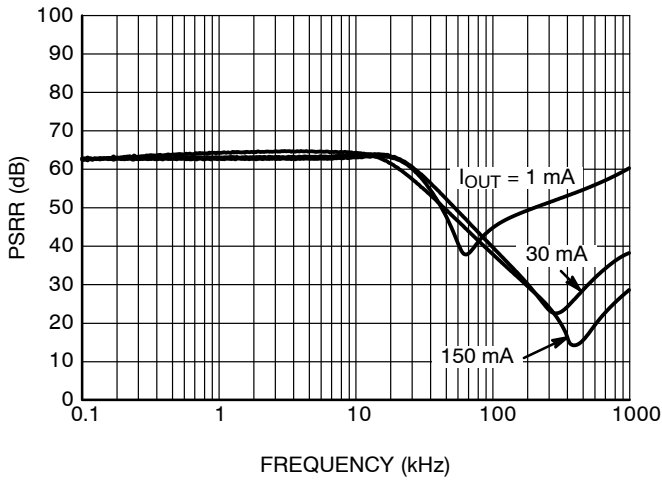

Figure 21. PSRR, 0.8 V Version,  $V_{IN} = 1.8$  V

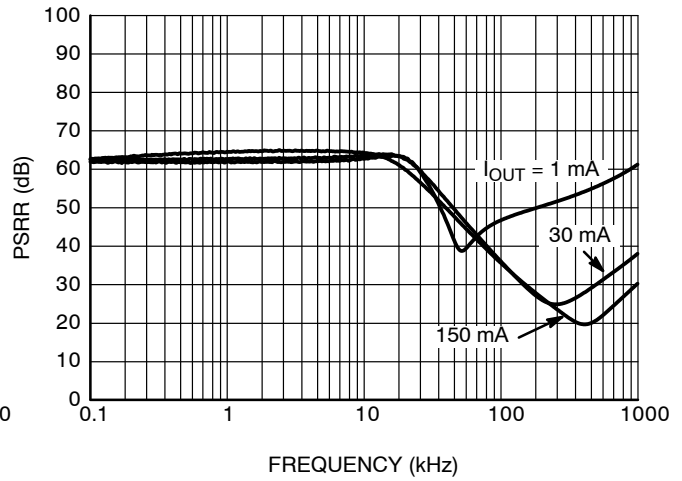

Figure 22. PSRR, 1.2 V Version,  $V_{IN} = 2.2$  V

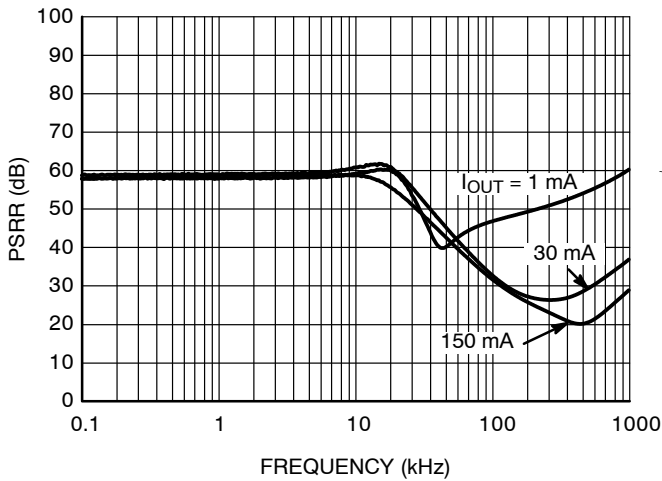

Figure 23. PSRR, 1.8 V Version,  $V_{IN} = 2.8$  V

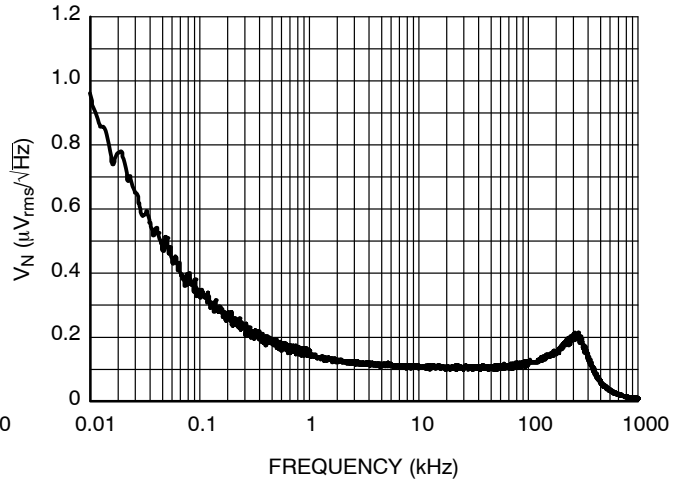

Figure 24. Output Voltage Noise, 0.8 V Version,  $V_{IN} = 1.8$  V,  $I_{OUT} = 30$  mA

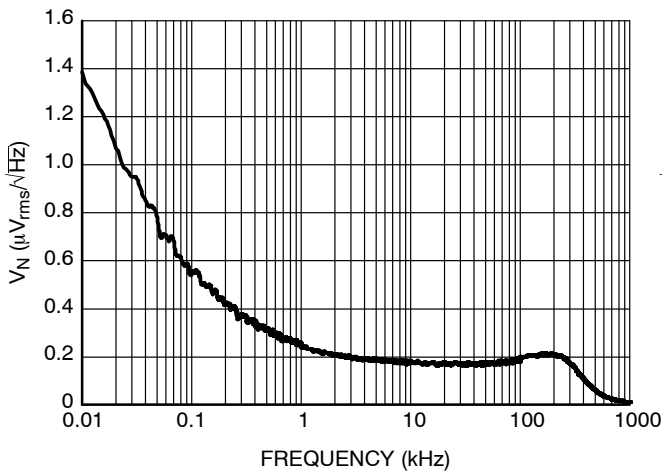

Figure 25. Output Voltage Noise, 1.2 V Version,  $V_{IN} = 2.2$  V,  $I_{OUT} = 30$  mA

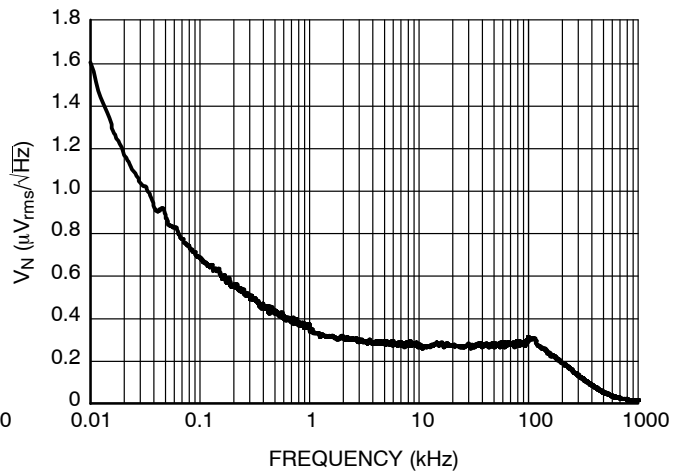

Figure 26. Output Voltage Noise, 1.8 V Version,  $V_{IN} = 2.8$  V,  $I_{OUT} = 30$  mA



# NCP4686

## TYPICAL CHARACTERISTICS

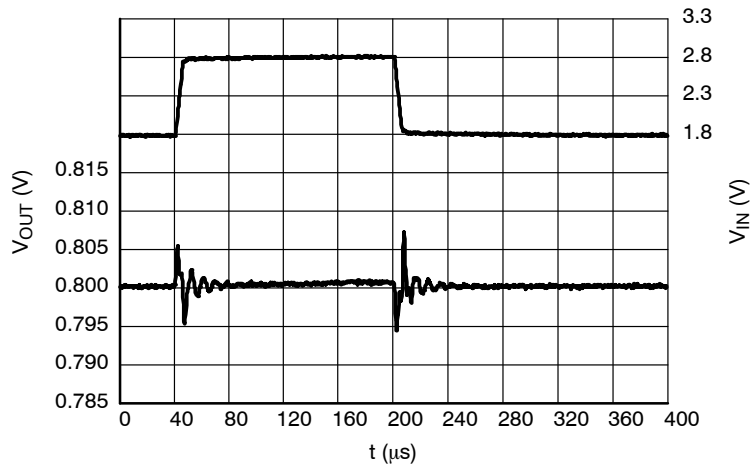

Figure 27. Line Transients, 0.8 V Version,  
 $t_R = t_F = 5 \mu\text{s}$ ,  $I_{OUT} = 30 \text{ mA}$

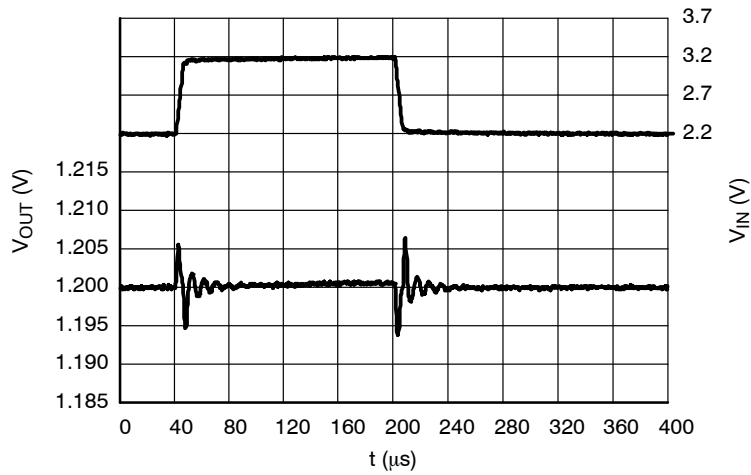

Figure 28. Line Transients, 1.2 V Version,  
 $t_R = t_F = 5 \mu\text{s}$ ,  $I_{OUT} = 30 \text{ mA}$

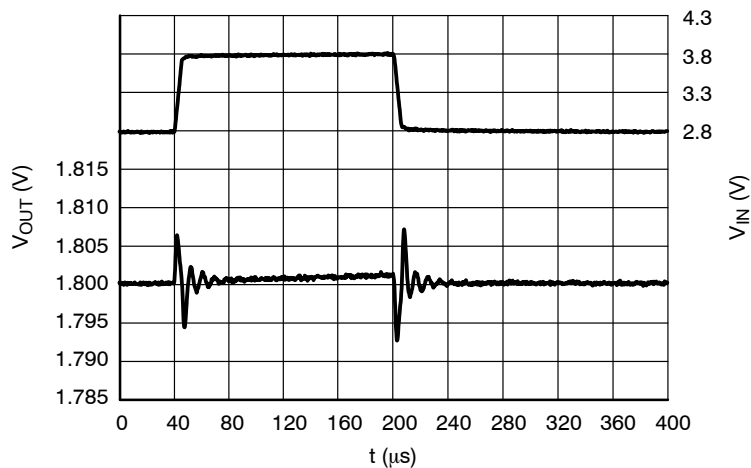
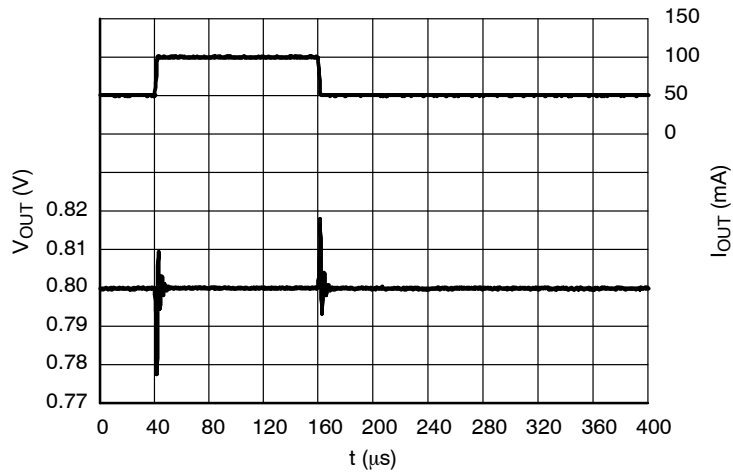

Figure 29. Line Transients, 1.8 V Version,  
 $t_R = t_F = 5 \mu\text{s}$ ,  $I_{OUT} = 30 \text{ mA}$

# NCP4686

## TYPICAL CHARACTERISTICS



**Figure 30. Load Transients, 0.8 V Version,  
 $I_{OUT} = 50 - 100$  mA,  $t_R = t_F = 0.5 \mu$ s,  $V_{IN} = 1.8$  V**

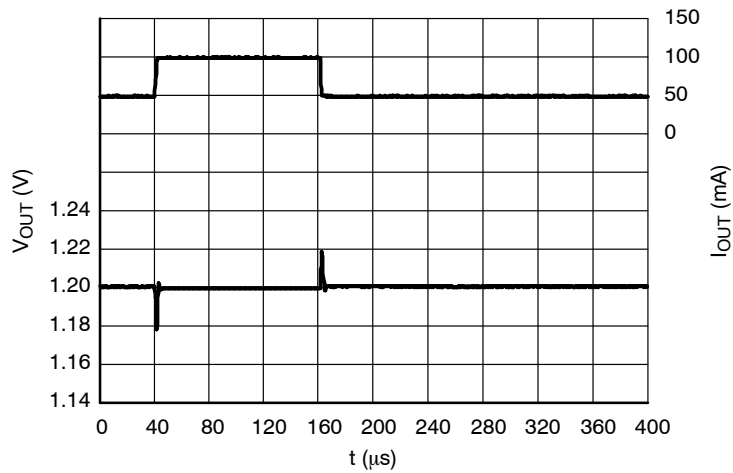

**Figure 31. Load Transients, 1.2 V Version,  
 $I_{OUT} = 50 - 100$  mA,  $t_R = t_F = 0.5 \mu$ s,  $V_{IN} = 2.2$  V**

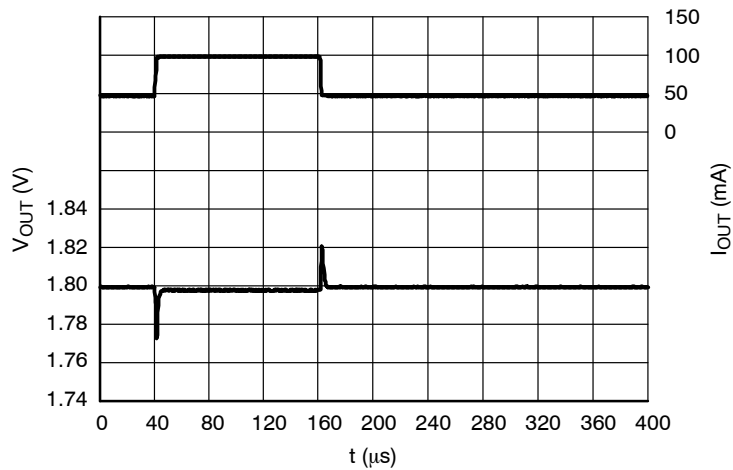

**Figure 32. Load Transients, 1.8 V Version,  
 $I_{OUT} = 50 - 100$  mA,  $t_R = t_F = 0.5 \mu$ s,  $V_{IN} = 2.8$  V**

# NCP4686

## TYPICAL CHARACTERISTICS

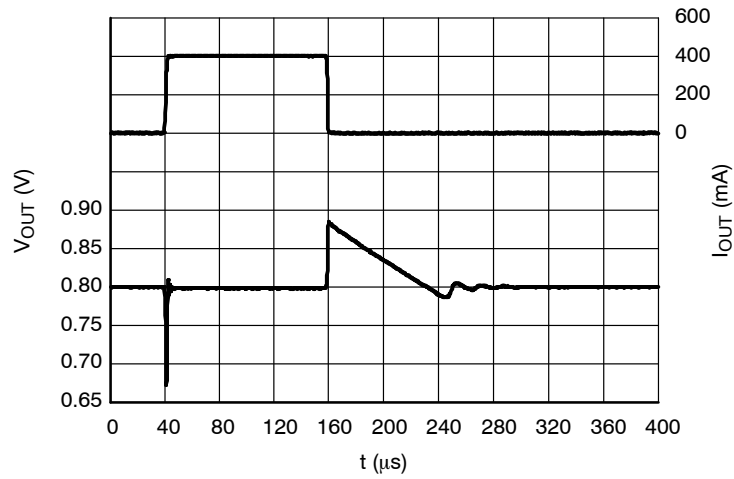

**Figure 33. Load Transients, 0.8 V Version,  
 $I_{OUT} = 1 - 400$  mA,  $t_R = t_F = 0.5$   $\mu$ s,  $V_{IN} = 1.8$  V**

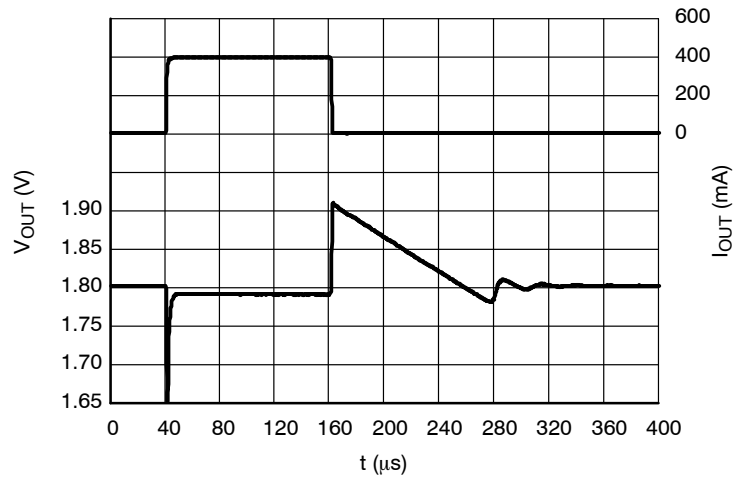

**Figure 34. Load Transients, 1.8 V Version,  
 $I_{OUT} = 1 - 400$  mA,  $t_R = t_F = 0.5$   $\mu$ s,  $V_{IN} = 2.8$  V**

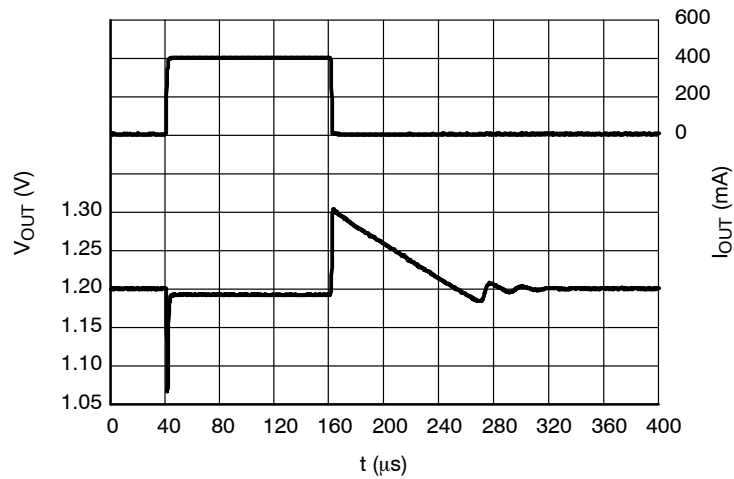

**Figure 35. Load transients, 1.2 V version,  
 $I_{OUT} = 1 - 400$  mA,  $t_R = t_F = 0.5$   $\mu$ s,  $V_{IN} = 2.2$  V**

# NCP4686

## TYPICAL CHARACTERISTICS

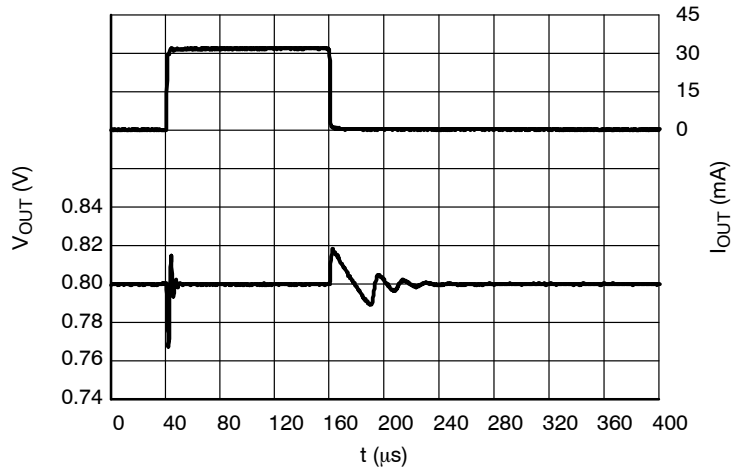

**Figure 36. Load Transients, 0.8 V Version,  
 $I_{OUT} = 1 - 30 \text{ mA}$ ,  $t_R = t_F = 0.5 \mu\text{s}$ ,  $V_{IN} = 1.8 \text{ V}$**

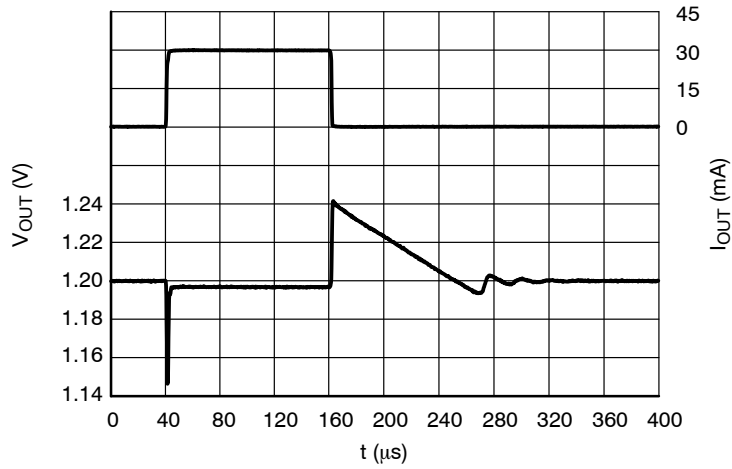

**Figure 37. Load Transients, 1.2 V Version,  
 $I_{OUT} = 1 - 30 \text{ mA}$ ,  $t_R = t_F = 0.5 \mu\text{s}$ ,  $V_{IN} = 2.2 \text{ V}$**

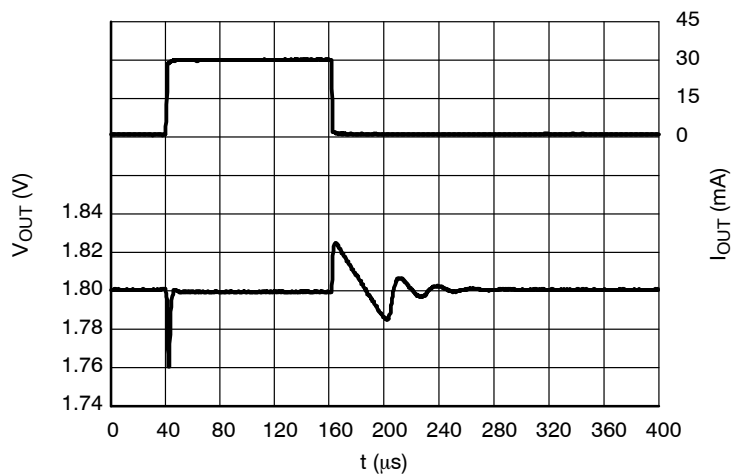

**Figure 38. Load Transients, 1.8 V Version,  
 $I_{OUT} = 1 - 30 \text{ mA}$ ,  $t_R = t_F = 0.5 \mu\text{s}$ ,  $V_{IN} = 2.8 \text{ V}$**

# NCP4686

## TYPICAL CHARACTERISTICS

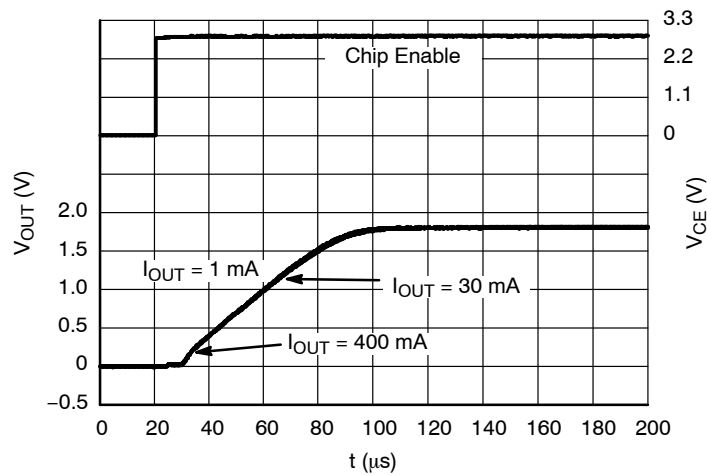
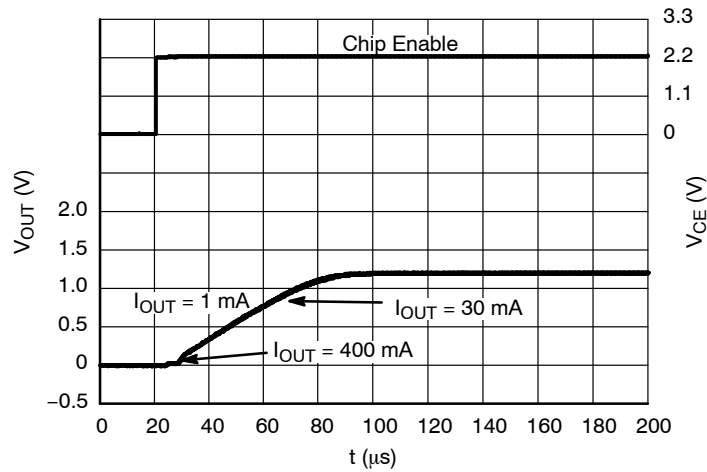
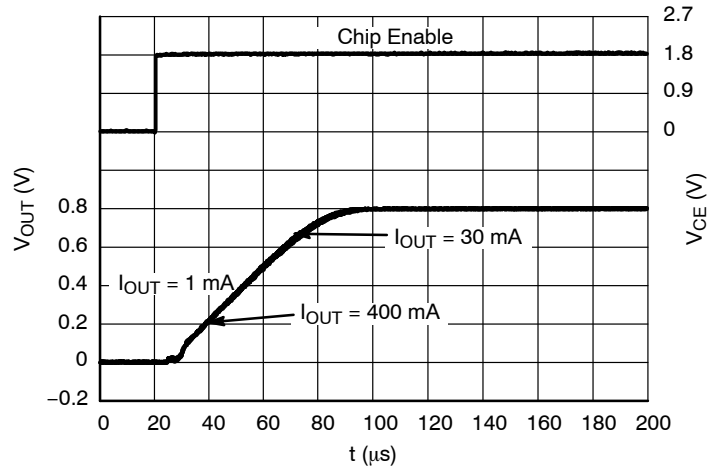

# NCP4686

## TYPICAL CHARACTERISTICS

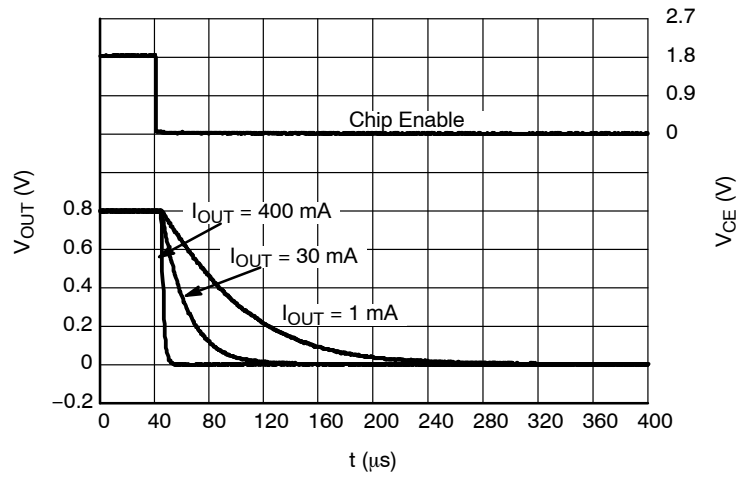

Figure 42. Shutdown, 0.8 V Version,  $V_{IN} = 1.8$  V

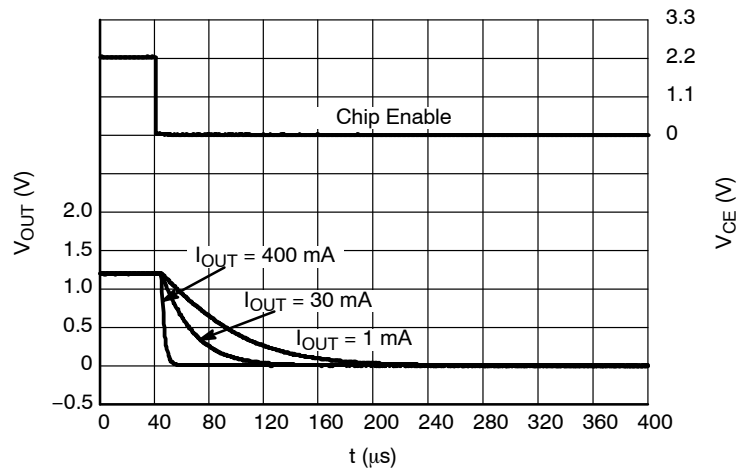

Figure 43. Shutdown, 1.2 V Version,  $V_{IN} = 2.2$  V

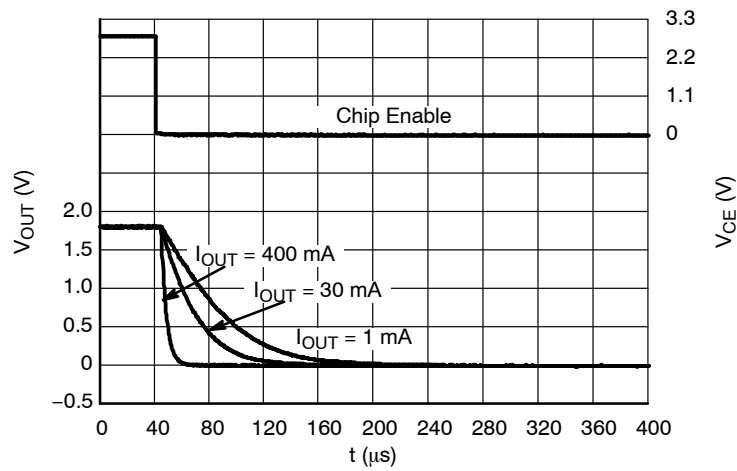

Figure 44. Shutdown, 1.8 V Version,  $V_{IN} = 2.8$  V

## APPLICATION INFORMATION

A typical application circuits for NCP4686 series is shown in Figure 45.

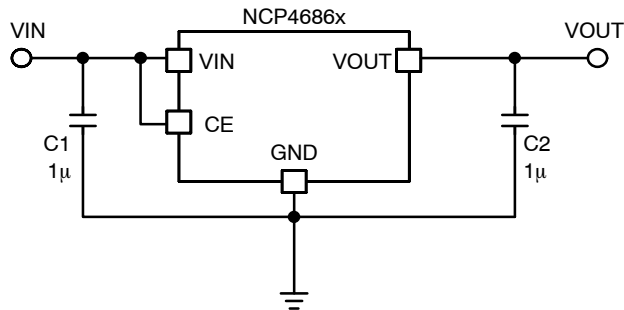

Figure 45. Typical Application Schematics

#### Input Decoupling Capacitor (C1)

A 1 µF ceramic input decoupling capacitor should be connected as close as possible to the input and ground pin of the NCP4686. Higher values and lower ESR improves line transient response.

#### Output Decoupling Capacitor (C2)

A 1 µF ceramic output decoupling capacitor is enough to achieve stable operation of the IC. If a tantalum capacitor is used, and its ESR is high, loop oscillation may result. The capacitors should be connected as close as possible to the output and ground pins. Larger values and lower ESR improves dynamic parameters.

#### Enable Operation

The enable pin CE may be used for turning the regulator on and off. The IC is switched on when a high level voltage is applied to the CE pin. The enable pin has an internal pull down current source. If the enable function is not needed connect CE pin to VIN.

#### Constant Slope Circuit

The constant slope circuit is used as a soft start circuit that allows the output voltage to start up slowly with a defined slope. This circuit minimizes inrush current at start up and

also prevents overshoot of the output voltage at start up. The Constant slope circuit is fully built in and no external component is needed. Since the Start up time and output voltage slope is defined internally, there is no way to change it. Starting up into bigger output capacitors doesn't cause problems due to the combination of the constant slope and current limit circuits.

#### Current Limit

This regulator includes fold-back type current limit circuit. This type of protection doesn't limit current up to current capability in normal operation, but when over current occurs, the output voltage and current decrease until the over current condition ends. Typical characteristics of this protection type can be observed in the Output Voltage versus Output Current graphs shown in the typical characteristics chapter of this datasheet.

#### Output Discharger

The NCP4686D version includes a transistor between VOUT and GND that is used for faster discharging of the output capacitor. This function is activated when the IC goes into disable mode.

#### Thermal

As power across the IC increase, it might become necessary to provide some thermal relief. The maximum power dissipation supported by the device is dependent upon board design and layout. Mounting pad configuration on the PCB, the board material, and also the ambient temperature affect the rate of temperature increase for the part. When the device has good thermal conductivity through the PCB the junction temperature will be relatively low in high power dissipation applications.

#### PCB Layout

Make the VIN and GND line as large as practical. If their impedance is high, noise pickup or unstable operation may result. Connect capacitors C1 and C2 as close as possible to the IC, and make wiring as short as possible.

### ORDERING INFORMATION

Device	Nominal Output Voltage	Description	Marking	Package	Shipping <sup>†</sup>
NCP4686DSN08T1G	0.8 V	Auto discharge	CAB	SOT23-5 (Pb-Free)	3000 / Tape & Reel
NCP4686DSN10T1G	1.0 V	Auto discharge	CAD	SOT23-5 (Pb-Free)	3000 / Tape & Reel
NCP4686DSN12T1G	1.2 V	Auto discharge	CAF	SOT23-5 (Pb-Free)	3000 / Tape & Reel
NCP4686DSN18T1G	1.8 V	Auto discharge	CAM	SOT23-5 (Pb-Free)	3000 / Tape & Reel

<sup>†</sup>For information on tape and reel specifications, including part orientation and tape sizes, please refer to our Tape and Reel Packaging Specifications Brochure, BRD8011/D.

\*To order other package and voltage variants, please contact your ON Semiconductor sales representative.

# NCP4686

## PACKAGE DIMENSIONS

SC-88A (SC-70-5/SOT-353)

CASE 419A-02

ISSUE K

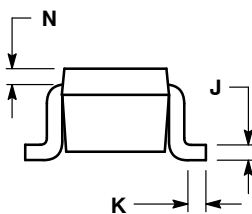
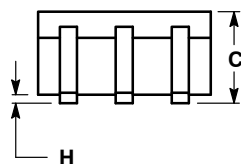
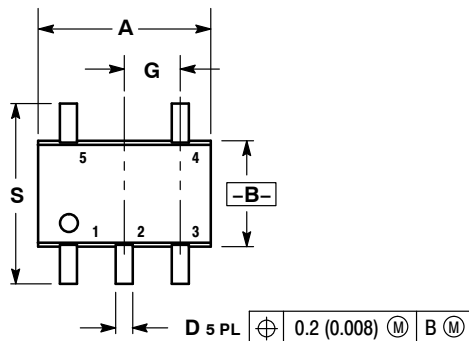

NOTES:

1. DIMENSIONING AND TOLERANCING PER ANSI Y14.5M, 1982.
2. CONTROLLING DIMENSION: INCH.
3. 419A-01 OBSOLETE. NEW STANDARD 419A-02.
4. DIMENSIONS A AND B DO NOT INCLUDE MOLD FLASH, PROTRUSIONS, OR GATE BURRS.

DIM	INCHES		MILLIMETERS	
	MIN	MAX	MIN	MAX
A	0.071	0.087	1.80	2.20
B	0.045	0.053	1.15	1.35
C	0.031	0.043	0.80	1.10
D	0.004	0.012	0.10	0.30
G	0.026 BSC		0.65 BSC	
H	---	0.004	---	0.10
J	0.004	0.010	0.10	0.25
K	0.004	0.012	0.10	0.30
N	0.008 REF		0.20 REF	
S	0.079	0.087	2.00	2.20



# NCP4686

## PACKAGE DIMENSIONS

SOT-23 5-LEAD  
CASE 1212-01  
ISSUE A

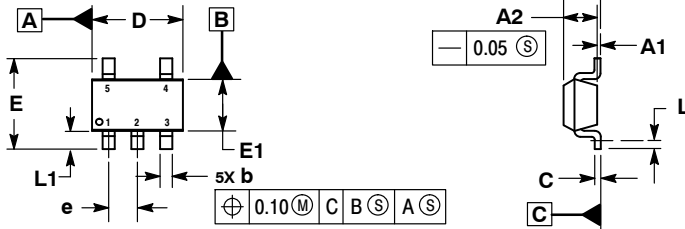

NOTES:

1. DIMENSIONING AND TOLERANCING PER ASME Y14.5M, 1994.
2. CONTROLLING DIMENSIONS: MILLIMETERS.
3. DATUM C IS THE SEATING PLANE.

MILLIMETERS		
DIM	MIN	MAX
A	---	1.45
A1	0.00	0.10
A2	1.00	1.30
b	0.30	0.50
c	0.10	0.25
D	2.70	3.10
E	2.50	3.10
E1	1.50	1.80
e	0.95 BSC	
L	0.20	---
L1	0.45	0.75

### RECOMMENDED SOLDERING FOOTPRINT\*

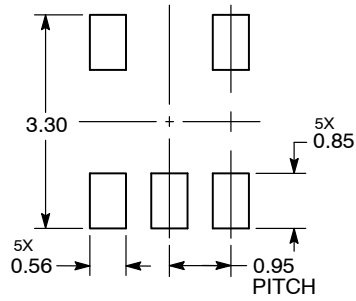

DIMENSIONS: MILLIMETERS

\*For additional information on our Pb-Free strategy and soldering details, please download the ON Semiconductor Soldering and Mounting Techniques Reference Manual, SOLDERRM/D.

# NCP4686

## PACKAGE DIMENSIONS

### XDFN6 1.2x1.2, 0.4P CASE 711AA-01 ISSUE O

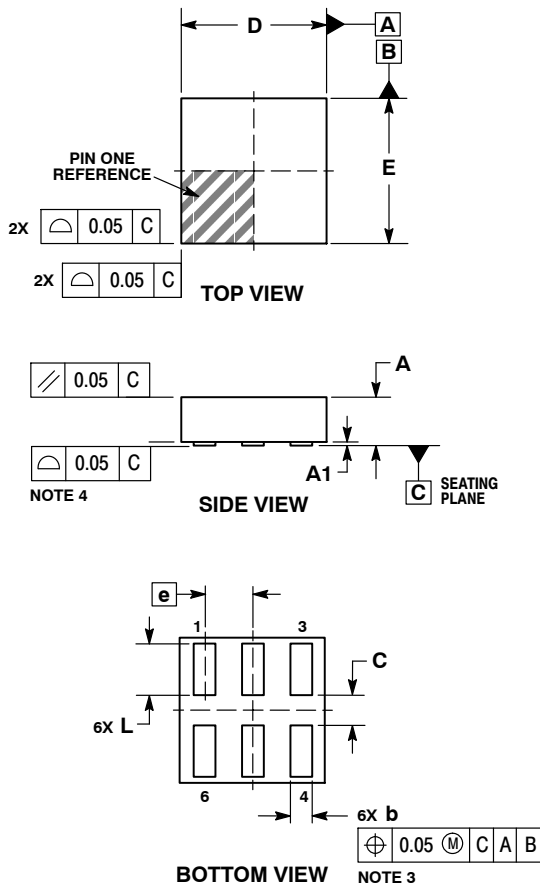

**NOTES:**

1. DIMENSIONING AND TOLERANCING PER ASME Y14.5M, 1994.
2. CONTROLLING DIMENSION: MILLIMETERS.
3. DIMENSION b APPLIES TO PLATED TERMINAL AND IS MEASURED BETWEEN 0.15 AND 0.25mm FROM TERMINAL TIPS.
4. COPLANARITY APPLIES TO ALL OF THE TERMINALS.

DIM	MILLIMETERS	
	MIN	MAX
A	---	0.40
A1	0.00	0.05
b	0.13	0.23
C	0.20	0.30
D	1.20 BSC	
E	1.20 BSC	
e	0.40 BSC	
L	0.37	0.48

### RECOMMENDED MOUNTING FOOTPRINT\*

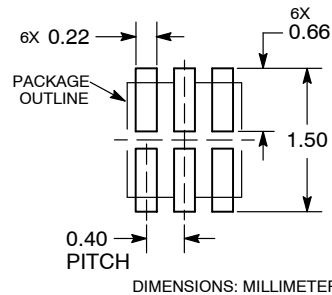

\*For additional information on our Pb-Free strategy and soldering details, please download the ON Semiconductor Soldering and Mounting Techniques Reference Manual, SOLDERRM/D.

ON Semiconductor and are registered trademarks of Semiconductor Components Industries, LLC (SCILLC). SCILLC reserves the right to make changes without further notice to any products herein. SCILLC makes no warranty, representation or guarantee regarding the suitability of its products for any particular purpose, nor does SCILLC assume any liability arising out of the application or use of any product or circuit, and specifically disclaims any and all liability, including without limitation special, consequential or incidental damages. "Typical" parameters which may be provided in SCILLC data sheets and/or specifications can and do vary in different applications and actual performance may vary over time. All operating parameters, including "Typicals" must be validated for each customer application by customer's technical experts. SCILLC does not convey any license under its patent rights nor the rights of others. SCILLC products are not designed, intended, or authorized for use as components in systems intended for surgical implant into the body, or other applications intended to support or sustain life, or for any other application in which the failure of the SCILLC product could create a situation where personal injury or death may occur. Should Buyer purchase or use SCILLC products for any such unintended or unauthorized application, Buyer shall indemnify and hold SCILLC and its officers, employees, subsidiaries, affiliates, and distributors harmless against all claims, costs, damages, and expenses, and reasonable attorney fees arising out of, directly or indirectly, any claim of personal injury or death associated with such unintended or unauthorized use, even if such claim alleges that SCILLC was negligent regarding the design or manufacture of the part. SCILLC is an Equal Opportunity/Affirmative Action Employer. This literature is subject to all applicable copyright laws and is not for resale in any manner.

### PUBLICATION ORDERING INFORMATION

**LITERATURE FULFILLMENT:**  
Literature Distribution Center for ON Semiconductor  
P.O. Box 5163, Denver, Colorado 80217 USA  
**Phone:** 303-675-2175 or 800-344-3860 Toll Free USA/Canada  
**Fax:** 303-675-2176 or 800-344-3867 Toll Free USA/Canada  
**Email:** orderlit@onsemi.com

**N. American Technical Support:** 800-282-9855 Toll Free USA/Canada  
**Europe, Middle East and Africa Technical Support:**  
Phone: 421 33 790 2910  
**Japan Customer Focus Center**  
Phone: 81-3-5817-1050

**ON Semiconductor Website:** [www.onsemi.com](http://www.onsemi.com)  
**Order Literature:** <http://www.onsemi.com/orderlit>  
For additional information, please contact your local Sales Representative