



**austriamicrosystems AG**

**is now**

**ams AG**

The technical content of this austriamicrosystems datasheet is still valid.

**Contact information:**

**Headquarters:**

ams AG

Tobelbaderstrasse 30

8141 Unterpremstaetten, Austria

Tel: +43 (0) 3136 500 0

e-Mail: [ams\\_sales@ams.com](mailto:ams_sales@ams.com)

Please visit our website at [www.ams.com](http://www.ams.com)

# AS3490

## Highly Efficient 2-6 LEDs Backlight Driver with PWM Input

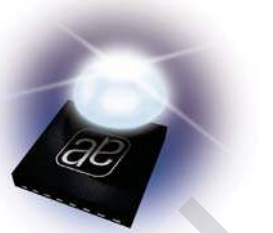

### 1 General Description

The AS3490 is an inductive highly efficient DCDC boost converter. The DCDC converter operates at a fixed frequency of 2MHz and includes soft startup to allow easy integration into noise sensitive RF systems. A predictable startup is guaranteed even with very low duty cycle PWM input signals. The voltage on the output capacitor is controlled to minimize ripple and to avoid any acoustic effects for low frequency PWM input signals.

The output of the DCDC converter is used for five current sources connected to up to 6 LEDs. If a current source is not required, it shall be connected to VOUT or GND - the AS3490 detects this condition and disables this current source automatically; this keeps the efficiency of the system constantly high.

The AS3490 is controlled by one enable input, ON. This input can also be used to connect a PWM input (like DLS or DBC).

The AS3490 includes several protection functions like undervoltage lockout, overcurrent and overtemperature.

No microvias are required to assemble the AS3490.

The AS3490 is available in a space-saving WL-CSP package measuring only 1.7x1.4x0.5mm and operates over the -30°C to +85°C temperature range.

### 2 Key Features

- 2 MHz DCDC Boost converter
  - Small 4.7µH external coil
  - Very high system efficiency of 86% (DCDC and current sources combined)
  - Very low voltage changes on output to avoid acoustic noise on output capacitor even with PWM
  - Smooth startup even under low duty cycle PWM conditions
- Three Current sources up to 25mA
  - Low voltage compliance (150mV)
  - High side current source to simplify layout and thermal management of the LEDs
  - Automatically detect and disable failing or not used LEDs to keep efficiency high
  - Current matching <4%
  - Current accuracy <7.5%
- Excellent LED current output ripple <500µA
- Support DLS (Dynamic Luminance Scaling or DBC)
- Undervoltage lockout and overcurrent protection
- Overtemperature protection
- Available in a tiny WL-CSP package
  - 3x4 balls, 0.4mm pitch, 1.7x1.4x0.5mm

### 3 Applications

Display backlight driver for mobile phones, digital cameras, PND and PMPs.

Figure 1. AS3490 Typical Operating Circuit

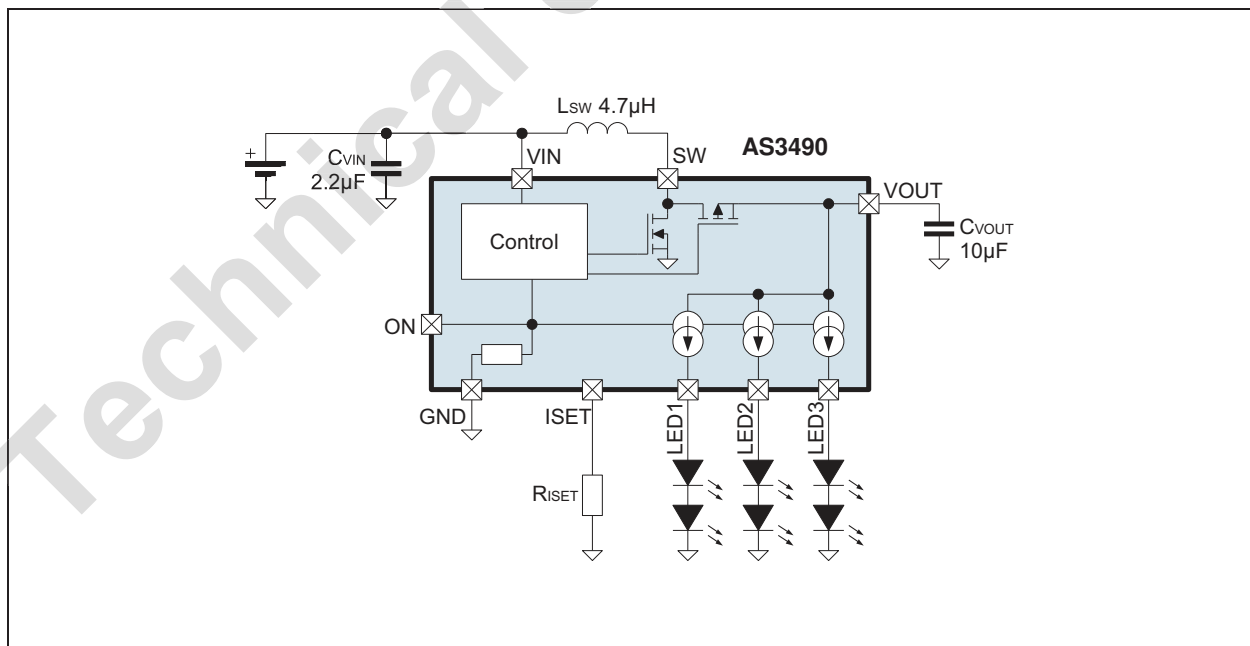

## 4 Pinout

### Pin Assignment

Figure 2. Pin Assignments (Top View)

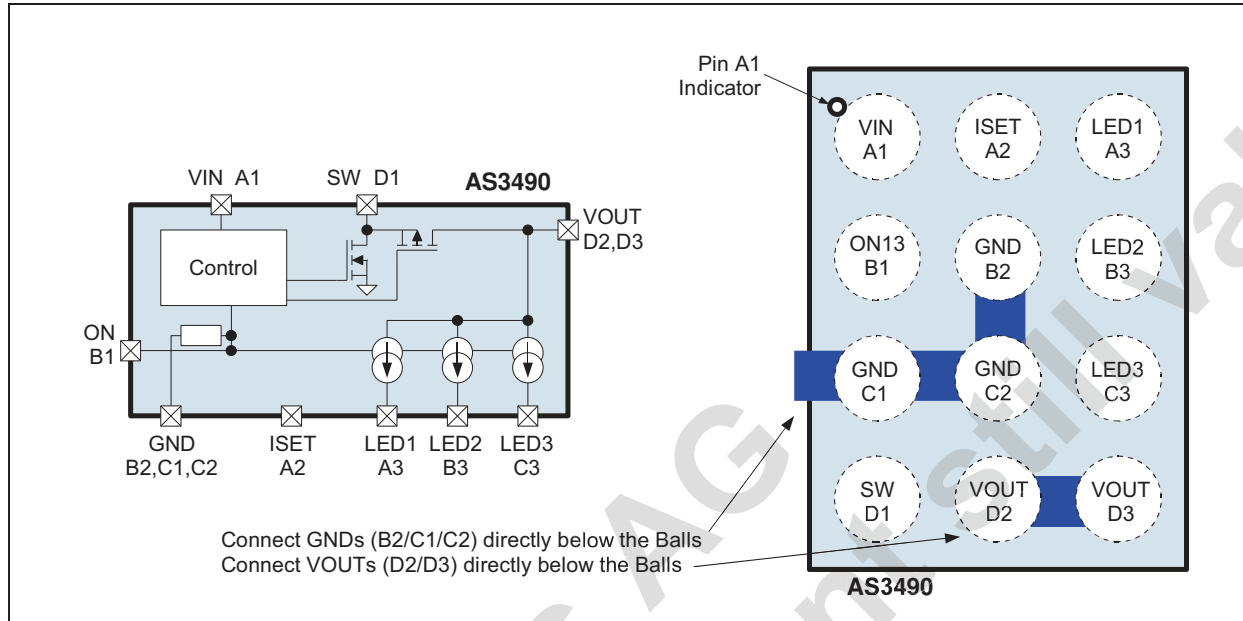

### Pin Description

Table 1. WL-CSP12 Pin Description

| Pin Number | Pin Name | Description   |
|------------|----------|---|
| A1         | VIN      | Positive supply voltage input - connect to supply and make a short connection to input capacitor C <sub>VIN</sub>       |
| A2         | ISET     | External current set resistor, forced to 1.25V in operation - LED current typically 400xISET current                    |
| A3         | LED1     | Current source output 1 - controlled by ON  |
| B1         | ON       | Digital input pin - enable input active high for current sources D1...D3 <sup>1</sup>                                   |
| B2         | GND      | Supply ground - connect to ground supply  |
| B3         | LED2     | Current source output 2 - controlled by ON  |
| C1         | GND      | Supply ground - connect to supply and make a short connection to input capacitor C <sub>VIN</sub> and C <sub>VOUT</sub> |
| C2         | GND      | Supply ground - connect to ground supply  |
| C3         | LED3     | Current source output 3 - controlled by ON  |
| D1         | SW       | DCDC converter switching node   |
| D2         | VOUT     | DCDC converter output - make a short connection to capacitor C <sub>OUT</sub>   |
| D3         | VOUT     | Connect directly to Ball D2   |

1. If ON is low low, the AS3490 enters shutdown.

## 5 Absolute Maximum Ratings

Stresses beyond those listed in Table 2 may cause permanent damage to the device. These are stress ratings only, and functional operation of the device at these or any other conditions beyond those indicated in Table 3, "Electrical Characteristics," on page 4 is not implied. Exposure to absolute maximum rating conditions for extended periods may affect device reliability.

Table 2. Absolute Maximum Ratings

| Parameter  | Min  | Max          | Units | Comments                                       |
|--|------|--------------|-------|--|
| VIN, ON and ISET to GND                          | -0.3 | +7.0         | V     |  |
| ON and ISET to VIN                               |      | +0.3         | V     | internal protection diodes to VIN              |
| SW, VOUT, LED1...LED3 to GND                     | -0.3 | 11           | V     |  |
| SW, LED1...LED3 to VOUT                          |      | +0.3         | V     | internal protection diodes to VOUT             |
| Input Pin Current without causing latchup        | -100 | +100<br>+IIN | mA    | Norm: EIA/JESD78                               |
| <b>Continuous Power Dissipation (TA = +70°C)</b> |      |              |       |  |
| Continuous power dissipation                     |      | 870          | mW    | PT <sup>1</sup> at TAMB=70°C                   |
| Continuous power dissipation derating factor     |      | 11.67        | mW/°C | PDERATE <sup>2</sup>                           |
| <b>Electrostatic Discharge</b>                   |      |              |       |  |
| ESD HBM  |      | ±2000        | V     | Norm: JEDEC JESD22-A114F                       |
| ESD CDM  |      | ±500         | V     | Norm: JEDEC JESD 22-C101E                      |
| ESD MM   |      | ±100         | V     | Norm: JEDEC JESD 22-A115-B                     |
| <b>Temperature Ranges and Storage Conditions</b> |      |              |       |  |
| Junction Temperature                             |      | +125         | °C    |  |
| Storage Temperature Range                        | -55  | +125         | °C    |  |
| Humidity   | 5    | 85           | %     | Non condensing                                 |
| Body Temperature during Soldering                |      | +260         | °C    | according to IPC/JEDEC J-STD-020               |
| Moisture Sensitivity Level (MSL)                 |      | MSL 1        |       | Represents a max. floor life time of unlimited |

1. Depending on actual PCB layout and PCB used

2. PDERATE derating factor changes the total continuous power dissipation (PT) if the ambient temperature is not 70°C. Therefore for e.g. TAMB=85°C calculate PT at 85°C = PT - PDERATE \* (85°C - 70°C)

## 6 Electrical Characteristics

V<sub>VIN</sub> = +2.5V to +5.5V, T<sub>AMB</sub> = -30°C to +85°C, unless otherwise specified. Typical values are at V<sub>VIN</sub> = +3.7V, T<sub>AMB</sub> = +25°C, unless otherwise specified.

Table 3. Electrical Characteristics

| Symbol                              | Parameter  | Condition  | Min                    | Typ    | Max                   | Unit |
|-------------------------------------|--|--|------------------------|--------|-----------------------|------|
| <b>General Operating Conditions</b> |  |  |                        |        |                       |      |
| V <sub>VIN</sub>                    | Supply Voltage                                   |  | 2.5                    | 3.7    | 5.5                   | V    |
| V <sub>VIN_REDUCED</sub>            | Supply Voltage reduced performance               | not all parameters within specification  | 2.3                    |        |                       | V    |
| I <sub>SHUTDOWN</sub>               | Shutdown Current                                 | ON=0V  |                        | 0.5    | 2.0                   | μA   |
| I <sub>VIN</sub>                    | Operating Current                                | no load, PWM Normal mode   |                        | 250    |                       | μA   |
| T <sub>AMB</sub>                    | Operating Temperature                            |  | -30                    | 25     | 85                    | °C   |
| <b>DCDC Converter parameters</b>    |  |  |                        |        |                       |      |
| V <sub>VOUT</sub>                   | Output Voltage V <sub>VOUT</sub>                 | automatically regulated  | V <sub>VIN</sub> +0.3V |        | V <sub>VOUT_MAX</sub> | V    |
|                                     |  | all other conditions with ON13=ON45  |                        |        | 140                   |      |
| V <sub>VOUT_RIPPLE_PWM</sub>        | Voltage V <sub>VOUT</sub> due to PWM signal      | DCDC not in pulseskip or current limit   |                        | 70     |                       | mV   |
| I <sub>LOAD</sub>                   | Load current                                     | V <sub>VOUT</sub> <7.5V  | 0.0                    |        | 100                   | mA   |
| η                                   | Overall Efficiency                               | V <sub>VIN</sub> =3.7V, T <sub>AMB</sub> = +25°C, LED mismatch ≤ 30mV, V <sub>VLED</sub> =3.0V |                        |        |                       |      |
|                                     |  | I <sub>LOAD</sub> =50mA  |                        | 86     |                       |      |
|                                     |  | I <sub>LOAD</sub> =75mA  | 85                     | 86     |                       |      |
|                                     |  | I <sub>LOAD</sub> =100mA   |                        | 86     |                       |      |
| f <sub>CLK</sub>                    | Operating Frequency                              | All internal timings are derived from this oscillator  | -10%                   | 2.0    | +10%                  | MHz  |
| t <sub>MIN_ON</sub>                 | Minimum on-time                                  |  |                        | 60     |                       | ns   |
| MDC                                 | Maximum Duty Cycle                               |  |                        | 90     |                       | %    |
| R <sub>SW_P</sub>                   | DCDC Switch SW - V <sub>VOUT</sub>               |  |                        | 0.5    |                       | Ω    |
| R <sub>SW_N</sub>                   | DCDC Switch SW - GND                             |  |                        | 0.5    |                       | Ω    |
| <b>Output voltage soft start</b>    |  |  |                        |        |                       |      |
| t <sub>VOUT_START</sub>             | softstart time                                   | measured from first high signal on ON  |                        | 1.2    |                       | ms   |
| V <sub>VOUT_START</sub>             | V <sub>VOUT</sub> startup voltage                |  |                        | 7.0    |                       | V    |
| t <sub>PWM_START_MAX</sub>          | Startup with PWM                                 | Maximum duration between PWM pulses during startup; see Figure 17 on page 11                   | 10                     | 11     | 12                    | ms   |
| t <sub>TIMEOUT</sub>                | DCDC timeout time                                | if ON=0 for t <sub>TIMEOUT</sub> , the DCDC is stopped and the AS3490 enters shutdown          | 29                     |        | 48                    | ms   |
| <b>Current Sources</b>              |  |  |                        |        |                       |      |
| V <sub>VLED1..3</sub>               | LED1...LED3 output voltage range                 |  | 2.6 x2                 | 3.3 x2 | 3.9 x2                | V    |
| I <sub>VLED1..3</sub>               | LED1...LED3 output current range                 |  | 0.0                    |        | 25.0                  | mA   |
| I <sub>VLED1..3Δ</sub>              | LED1...LED3 current source accuracy <sup>1</sup> | I <sub>VLED1..3</sub> =20mA  | -7.5                   |        | +7.5                  | %    |

Table 3. Electrical Characteristics (Continued)

| Symbol                                    | Parameter                                     | Condition  | Min                     | Typ  | Max              | Unit                  |
|---|---|--|-------------------------|------|------------------|-----------------------|
| I <sub>LED1..3</sub> MATCH                | LED1...LED3 current source matching           | I <sub>LED1..3</sub> = 20mA  | -4.0                    |      | +4.0             | %                     |
| I <sub>LED1..3</sub> RIPPLE               | LED1...LED3 ripple current                    | BW=10MHz   | I <sub>LED</sub> > 5mA  |      | 10               | % of I <sub>LED</sub> |
|   |   |  | I <sub>LED</sub> < 5mA  |      | 500              | µA                    |
| I <sub>LED1..3</sub> PWMLIN               | LED1...LED3 linearity <sup>2</sup>            | I <sub>LED</sub> =20mA,<br>PWM frequency 300Hz   | PWM>=25/255             | -2   | +2               | %                     |
|   |   |  | 25/255><br>PWM>=1/255   | -10  | +10              | %                     |
| f <sub>PWM</sub>                          | PWM input frequency                           | on pin ON  | 100                     | 300  | 800              | Hz                    |
| I <sub>LED1..3</sub> LEAKAGE              | LED1...LED3 leakage current                   | current source off, T <sub>AMB</sub> < +50°C   | -0.5                    | 0    | +0.5             | µA                    |
| V <sub>ILED_COMP</sub>                    | LED1...LED3 current source voltage compliance | Minimum voltage between pin V <sub>OUT</sub> and LED1...LED3, I <sub>LED</sub> <20mA <sup>3</sup>  | 100                     |      |                  | mV                    |
| <b>Current Reference (pin ISET)</b>       |   |  |                         |      |                  |                       |
| V <sub>ISET</sub>                         | ISET voltage                                  |  |                         | 1.25 |                  | V                     |
| I <sub>LED2ISET</sub>                     | LED current to ISET current                   |  |                         | 400  |                  | A/A                   |
| <b>Protection Functions (see page 12)</b> |   |  |                         |      |                  |                       |
| V <sub>VOUT_MAX</sub>                     | V <sub>OUT</sub> overvoltage protection       |  | 8.6                     |      | 10.0             | V                     |
| V <sub>VOUT_OPE</sub><br>N <sub>LED</sub> | V <sub>OUT</sub> open LED detection threshold | Voltage level on V <sub>OUT</sub> where open LED detection is performed  | 8.0                     | 8.5  | 8.8              | V                     |
| V <sub>LED_OPEN</sub>                     | V <sub>LED1..3</sub> open detection           | an open LED is assumed if the voltage on the current source is less than V <sub>LED_OPEN</sub> and V <sub>OUT</sub> =V <sub>VOUT_OPENLED</sub> |                         | 92   | 125              | mV                    |
| V <sub>LED_SHORT</sub>                    | V <sub>LED1..3</sub> short detection          | voltage on LED1..3 where a shorted LED is assumed  |                         | 0.95 |                  | V                     |
| t <sub>LED_ERROR_DEB_OPEN</sub>           | V <sub>LED1..3</sub> open debounce time       | Open LED detection debounce time   |                         |      | 4.8              | µs                    |
| t <sub>LED_ERROR_DEB_SHORT</sub>          | V <sub>LED1..3</sub> short debounce time      | Short LED detection debounce time <sup>4</sup>   |                         |      | 9.0              | µs                    |
| I <sub>LIMIT</sub>                        | Current Limit for coil LSW (Pin SW)           |  | 510                     | 600  | 685              | mA                    |
| T <sub>OVTEMP</sub>                       | Overtemperature Protection                    | Junction temperature   |                         | 144  |                  | °C                    |
| T <sub>OVTEMPHYST</sub>                   | Overtemperature Hysteresis                    |  |                         | 5    |                  | °C                    |
| V <sub>VVLO</sub>                         | Undervoltage Lockout                          | Falling V <sub>VIN</sub>   | 1.8                     | 1.9  | 2.1              | V                     |
|   |   | Rising V <sub>VIN</sub>  | V <sub>VVLO</sub> +0.05 | 2.2  | 2.3              | V                     |
| <b>Digital Interface</b>                  |   |  |                         |      |                  |                       |
| V <sub>IH</sub>                           | High Level Input Voltage                      |  | 1.07                    |      | V <sub>VIN</sub> | V                     |
| V <sub>IL</sub>                           | Low Level Input Voltage                       |  | 0.0                     |      | 0.68             | V                     |
| R <sub>PULLDOWN</sub>                     | Pulldown resistor                             | 1.8V on pad  | 90                      | 250  |                  | kΩ                    |

1. Excluding variation of external resistor R<sub>ISET</sub>; voltage difference between any set of drivers less than 200mV

2. Note: It is not recommended to operate the current sources at minimum duty cycle with low LED currents.
3. The dcdc output voltage VOUT is regulated to 150mV above the maximum LED voltage (LED1...LED3) to guarantee proper operation of the current with output voltage ripple and undershoots (e.g. due to PWM or supply voltage changes)
4. The short LED detection debounce time is longer than the open LED detection debounce time to allow the parasitic capacitance of the LED to charge above VLED\_SHORT within this time and avoid wrong triggering of short LED detection.

ams AG  
Technical content still valid



## 7 Typical Operating Characteristics

V<sub>BAT</sub> = 3.7V, T<sub>A</sub> = +25°C (unless otherwise specified).

Figure 3. DCDC Efficiency vs. V<sub>BAT</sub>

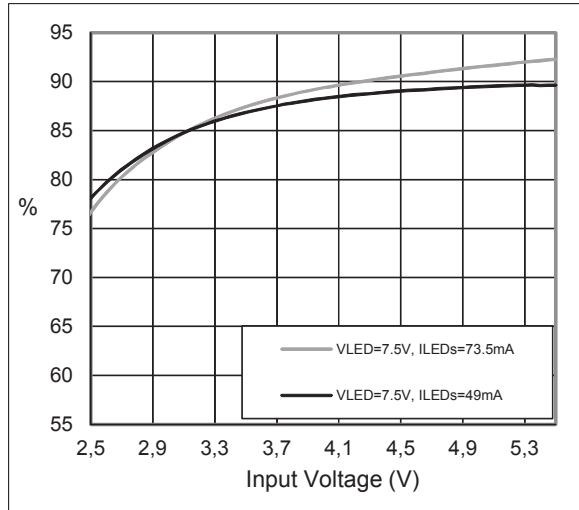

Figure 4. LED Efficiency vs. V<sub>BAT</sub>

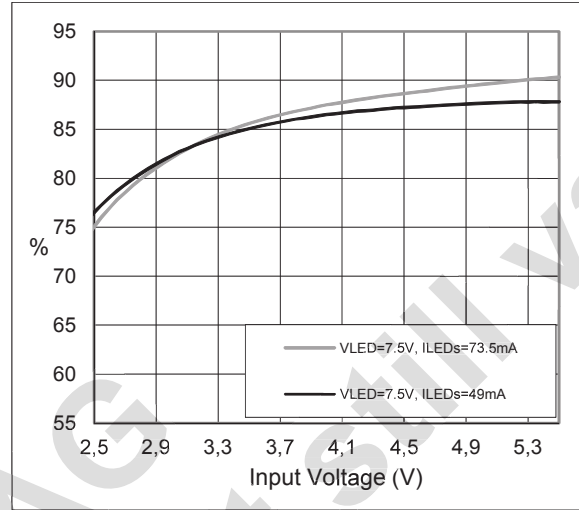

Figure 5. Efficiency vs. Load Current

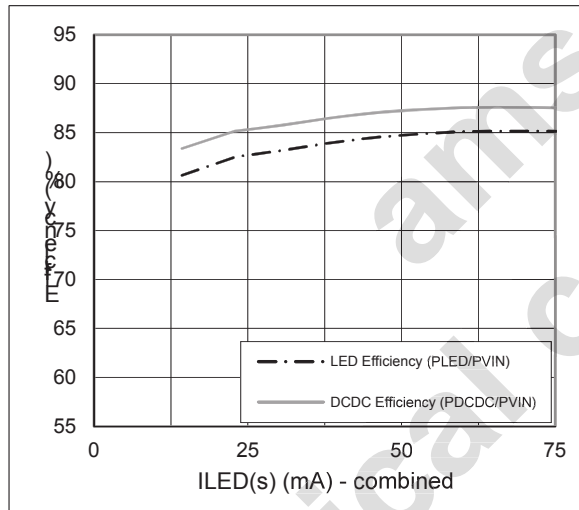

Figure 6. Startup with PWM, 20% duty cycle

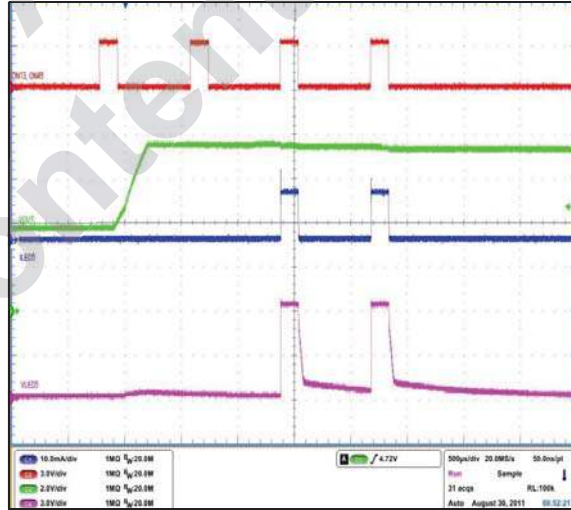

Figure 7. Startup with PWM, 70% duty cycle



Figure 8. DCDC Switching Waveforms

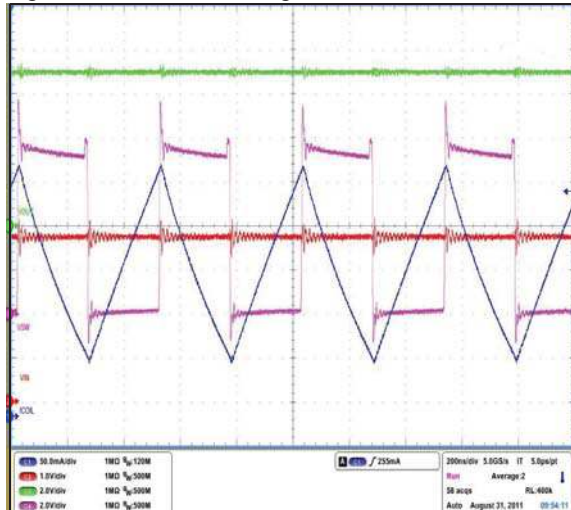



Figure 9. Open LED Detection Waveform

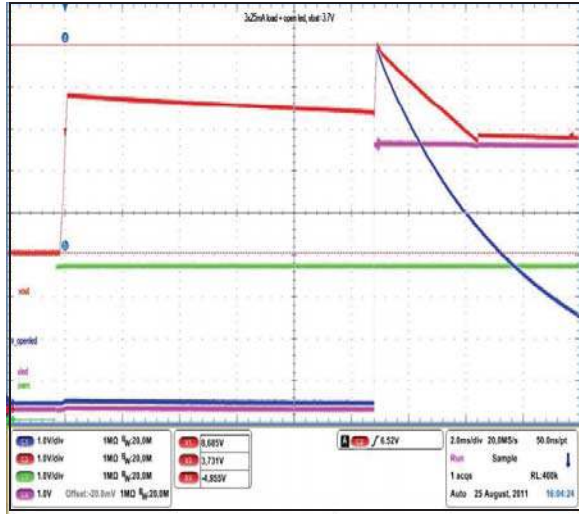

Figure 10. VIN line transient 10μs (I<sub>LOAD</sub>=100mA)

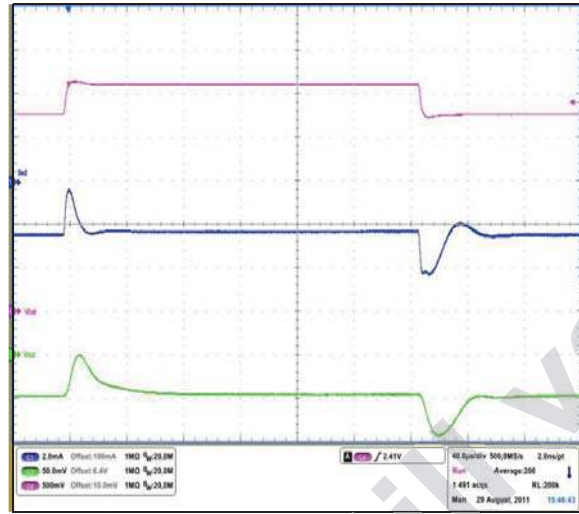

Figure 11. V<sub>OUT</sub> ripple with PWM



Figure 12. I<sub>LED</sub> ripple (I<sub>LOAD</sub>=100mA)

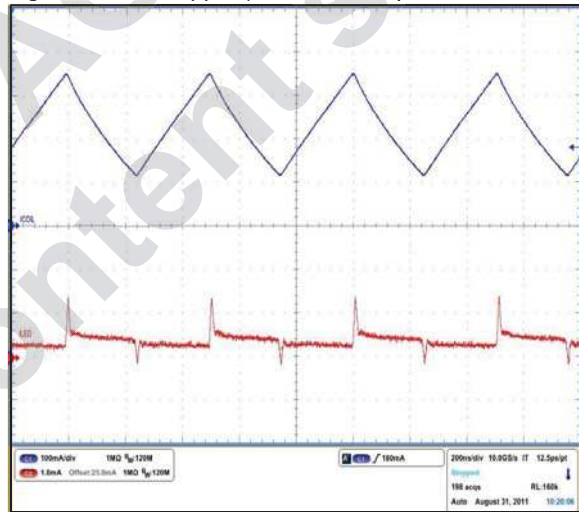

Figure 13. I<sub>LED</sub> vs. R<sub>ISET</sub>

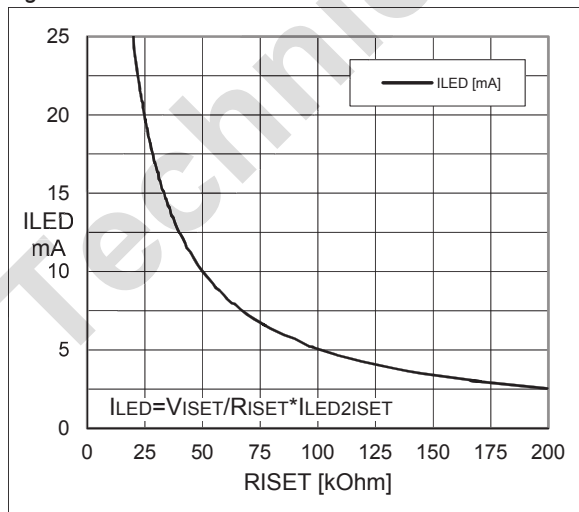

Figure 14. f<sub>osc</sub> vs. V<sub>IN</sub>

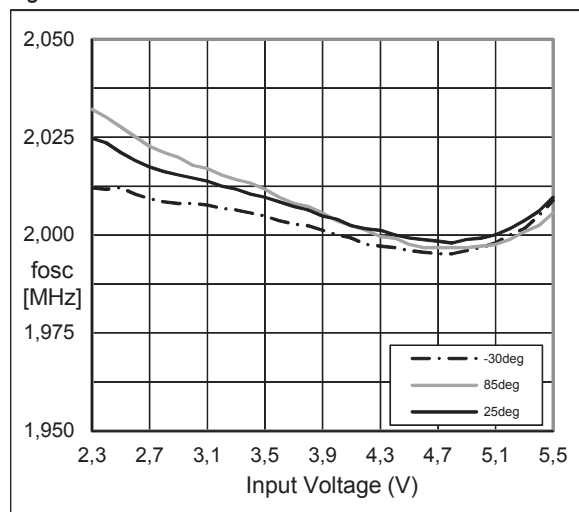
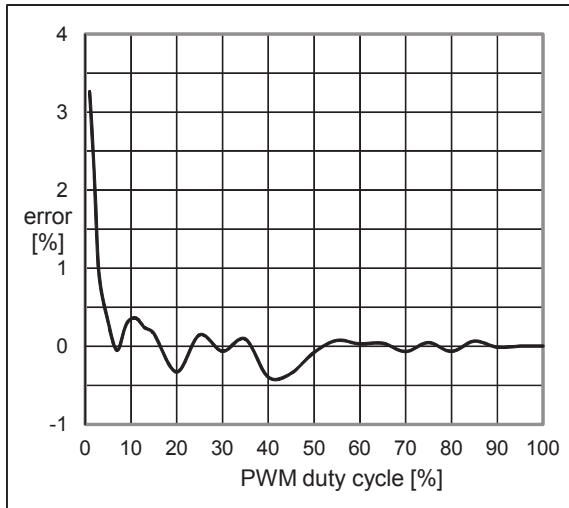

Figure 15. Current Error vs. duty cycle ( $I_{LED}=25mA$ )

## 8 Detailed Description

The AS3490 is a high performance DCDC step up converter and three current sources in a small WL-CSP12 package.

The LED configuration is done in up to three strings<sup>1</sup>, each strings using two LEDs in series<sup>2</sup>. This configuration results in excellent application efficiency even using very small external components (capacitors and coil). The device is controlled by ON. A high levels on this input enables the DCDC and the current sources. ON can be used as PWM input<sup>3</sup> to accurately control the LED brightness.

The target application is to use the AS3490 for highly efficient backlight driver (display and/or keypad backlight).

### Internal Circuit

Figure 16. AS3490 internal circuit

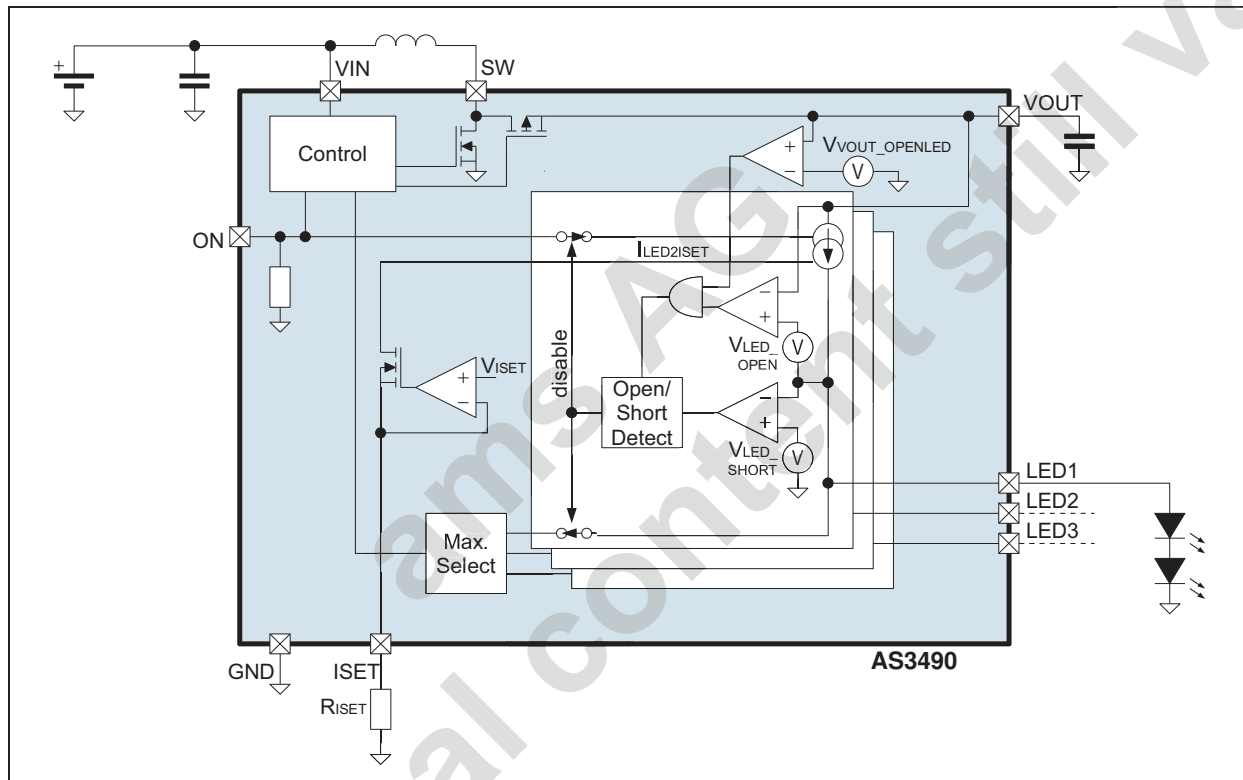

The AS3490 includes a fixed frequency DCDC step-up with accurate startup control. It is enabled by the input pin ON and controls the LED current with five current sources. These input can be used as PWM inputs to control the brightness:

- a high level on ON enables LED1, LED2 and LED3

The current is adjustable by an external resistor Riset.

1. Unused strings shall be connected to VOUT or GND.
2. Single LED strings can be mixed with dual LED strings as long as one string has two LEDs in series - it will reduce application efficiency.
3. Using the PWM inputs, the AS3490 supports DLS, dynamic luminance scaling, also called CABC, content adaptive backlight control or DBC, dynamic backlight control.

## Startup

In order to avoid inrush-current during startup the supplies are smoothly ramped up according to Figure 17 even under low PWM duty cycle conditions. This allows the easy integration into mobile battery powered systems:

Figure 17. Startup Procedure

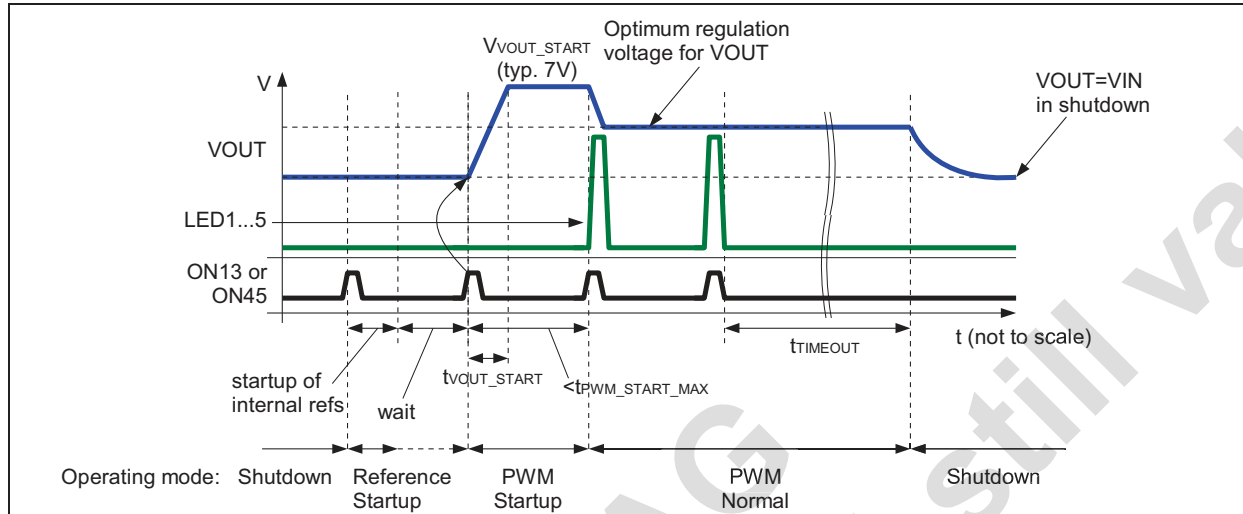

## Open and short LED detection

After the startup is finished, the AS3490 continuously monitors open and shorted LEDs. If an open or shorted LED string is detected, this LED string is disabled and the driver continues its normal operation. The driver is disabled to keep the efficiency of AS3490 for different LED configurations high. The error is cleared once the AS3490 enters shutdown<sup>4</sup>.

### Shorted LED

After startup is finished, for any LED, enabled by the inputs ON, is below  $V_{LED\_SHORT}$ , for at least  $t_{LED\_ERROR\_DEB\_SHORT}$ , a shorted LED is assumed.

### Open LED

LED outputs (LED1...LED5) which are not used by the application shall be connected permanently to VOUT or GND. The AS3490 detects this condition upon startup and automatically disables the current sources for these LEDs - see Figure 18 and Figure 19, immediately after the rising edge of ON.

For LEDs, which are open during operation of the device, following procedure of the AS3490 is used for detection:

After startup is finished, if the voltage on  $V_{OUT}=V_{V_{OUT\_OPENLED}}$ <sup>5</sup> and the voltage across any current source, enabled by the inputs ON, is below  $V_{LED\_OPEN}$  ( $V_{OUT}-LED1...3$ ), for at least  $t_{LED\_ERROR\_DEB\_OPEN}$ , an open LED is assumed.

Figure 18 shows the waveform for the detection of a single open LED, Figure 19 for all LEDs open.

4. The error is automatically cleared as the open/short LED error might be temporarily (e.g. bouncing of the connections to the LED)
5. If the current limit of the coil ( $I_{LIMIT}$ ) is reached before  $V_{OUT}=V_{V_{OUT\_OPENLED}}$ , an open LED is not detected.

Figure 18. Single Open LED detection

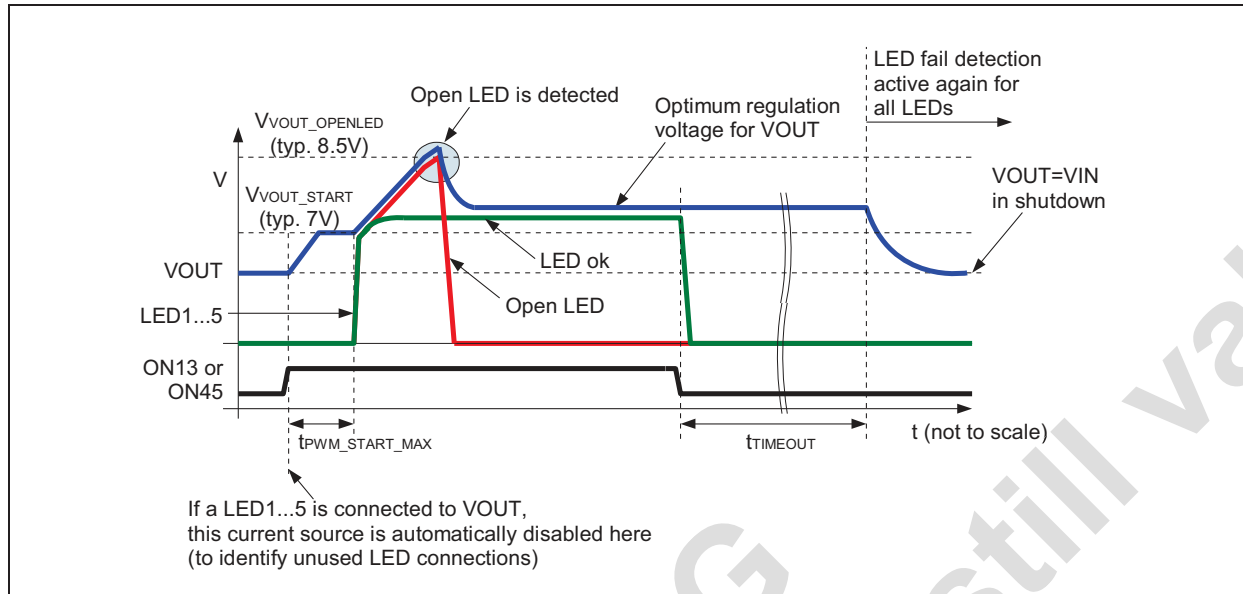
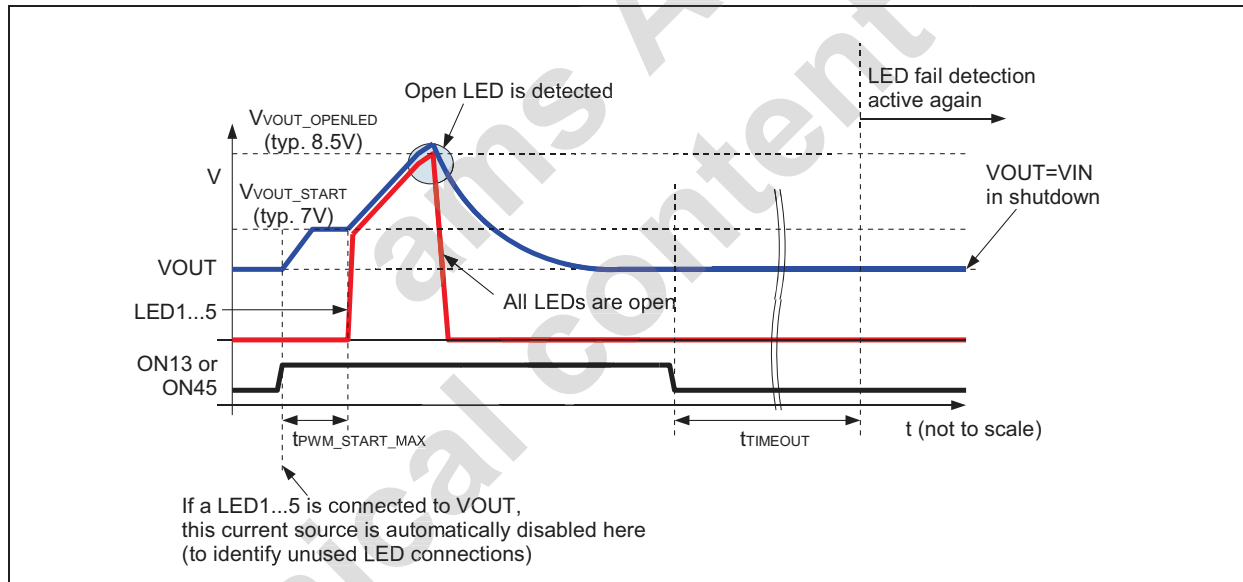

Figure 19. All LEDs open



## Protection and Fault Detection Functions

The protection functions protect the AS3490, its external components and connected LEDs against physical damage.

### Overvoltage Protection

The voltage on VOUT is kept below or at  $V_{VOUT\_MAX}$  under every operating condition<sup>6</sup>. If the voltage on VOUT is at  $V_{VOUT\_MAX}$  for more than 70ms<sup>7</sup>, the DCDC will shutdown. It can be re-enabled by setting ON to low for more than  $t_{TIMEOUT}$ .

6. When reaching  $V_{OUT}=V_{VOUT\_OPENLED}$ , the open LED detection is performed.

7. The duration can vary from 55ms to 85ms within a single AS3490.

**DCDC Inductor Peak Current Limitation**

To limit the maximum current from the battery, the DCDC converter limits its current through the coil to  $I_{LIMIT}$  on a cycle by cycle basis.

**Overtemperature Protection**

The junction temperature of the AS3490 is continuously monitored. If the temperature exceeds  $T_{OVTEMP}$ , the DCDC is stopped. The driver is automatically re-enabled once the junction temperature drops below  $T_{OVTEMP} - T_{OVTEMPHYST}$ .

**Supply undervoltage Protection**

If the voltage on the pin VIN is or falls below  $V_{UVLO}$ , the AS3490 is kept in shutdown.

ams AG  
Technical content still valid

## 9 Application Information

### External Components

#### Input Capacitor $C_{VIN}$

Low ESR input capacitors reduce input switching noise and reduce the peak current drawn from the battery. Ceramic capacitors are required for input decoupling and should be located as close to the device as is practical.

Table 4. Recommended Input Capacitor

| Part Number       | C                  | TC Code | ESR | Rated Voltage | Size                        | Manufacturer   |
|-------------------|--------------------|---------|-----|---------------|-----------------------------|--|
| GRM155R60J225ME15 | 2.2 $\mu$ F +/-20% | X5R     |     | 6V3           | 0402<br>(1.0x0.5x<br>0.5mm) | Murata<br><a href="http://www.murata.com">www.murata.com</a>                     |
| GRM155R60J155M--D | 1.5 $\mu$ F        | X5R     |     | 6V3           |                             |  |
| ECJ0MBFJ185V      |                    | X5R     |     |               | 0402<br>(1.0x0.5x<br>0.5mm) | Panasonic Matsushita<br><a href="http://www.panasonic.com">www.panasonic.com</a> |
| JDK105BJ155MVNF   |                    | X5R     |     |               | 0402<br>(1.0x0.5x<br>0.5mm) | Taiyo Yuden<br><a href="http://www.taiyo-yuden.com">www.taiyo-yuden.com</a>      |

If a different input capacitor is chosen, ensure similar ESR value and at least 0.6 $\mu$ F capacitance at the maximum input supply voltage. Larger capacitor values (C) may be used without limitations.

#### Output Capacitors $C_{OUT}$

Low ESR capacitors should be used to minimize  $V_{OUT}$  ripple. Multi-layer ceramic capacitors are recommended since they have low ESR and are available in small footprints. The capacitor should be located as close to the device as is practical.

X5R dielectric material is recommended due to their ability to maintain capacitance over wide voltage and temperature range.

Table 5. Recommended Output Capacitor  $C_{OUT}$

| Part Number        | C          | TC Code | ESR           | Rated Voltage | Size                        | Manufacturer  |
|--------------------|------------|---------|---------------|---------------|-----------------------------|---|
| GRM219R61A116UE82L | 10 $\mu$ F | X5R     | 120m $\Omega$ | 10V           | 0805<br>(2x1.25x<br>0.85mm) | Murata<br><a href="http://www.murata.com">www.murata.com</a>                |
| LDK212BJ106MDNT    | 10 $\mu$ F | X5R     |               | 10V           | 0805<br>(2x1.25x<br>0.85mm) | Taiyo Yuden<br><a href="http://www.taiyo-yuden.com">www.taiyo-yuden.com</a> |

If a different output capacitor is chosen, ensure similar ESR values and at least 4.2 $\mu$ F @ 5.6V and maximum 20 $\mu$ F capacitance.



### Inductor L<sub>SW</sub>

The fast switching frequency (2MHz) of the AS3490 allows for the use of small SMDs for the external inductor. The inductor should have low DC resistance (DCR) to reduce the  $I^2R$  power losses - high DCR values will reduce efficiency.

Table 6. Recommended Inductor

| Part Number   | L                         | DCR    | Size                               | Manufacturer  |
|---------------|---------------------------|--------|------------------------------------|---|
| LQM2HPN4R7MGC | 4.7µH;<br>>2.45µH @ 0.5A  | 160mΩ  | 2.5x2.0x0.9mm<br>max height 1.0mm  | Murata<br><a href="http://www.murata.com">www.murata.com</a>                                  |
| CIG32K1R0SAF  | 4.57µH;<br>>2.45µH @ 0.5A | <300mΩ | 2.0x1.25x0.9mm<br>max height 1.0mm | Samsung Electro-Mechanics<br><a href="http://www.sem.samsung.co.kr">www.sem.samsung.co.kr</a> |

If a different inductor is chosen, ensure similar DCR values and at least 2.45µH inductance at maximum peak input current.

### PCB Layout Guideline

The high speed operation requires proper layout for optimum performance. Route the power traces first and try to minimize the area and wire length of the three high frequency/high current loops:

Loop1: pin GND - C<sub>VIN</sub> - L<sub>SW</sub> - pin SW - pin GND

Loop2: pin GND - C<sub>VIN</sub> - L<sub>SW</sub> - pin SW - pin VOUT - C<sub>VOUT</sub> - pin GND

At the pin GND a single via (or more vias, which are closely combined) connects to the common ground plane. This via(s) will isolate the DCDC high frequency currents from the common ground (as most high frequency current will flow between Loop1 and Loop2 and will not pass the ground plane) - see the 'island' at the two through ground vias in Figure 20:

Figure 20. Layout recommendation

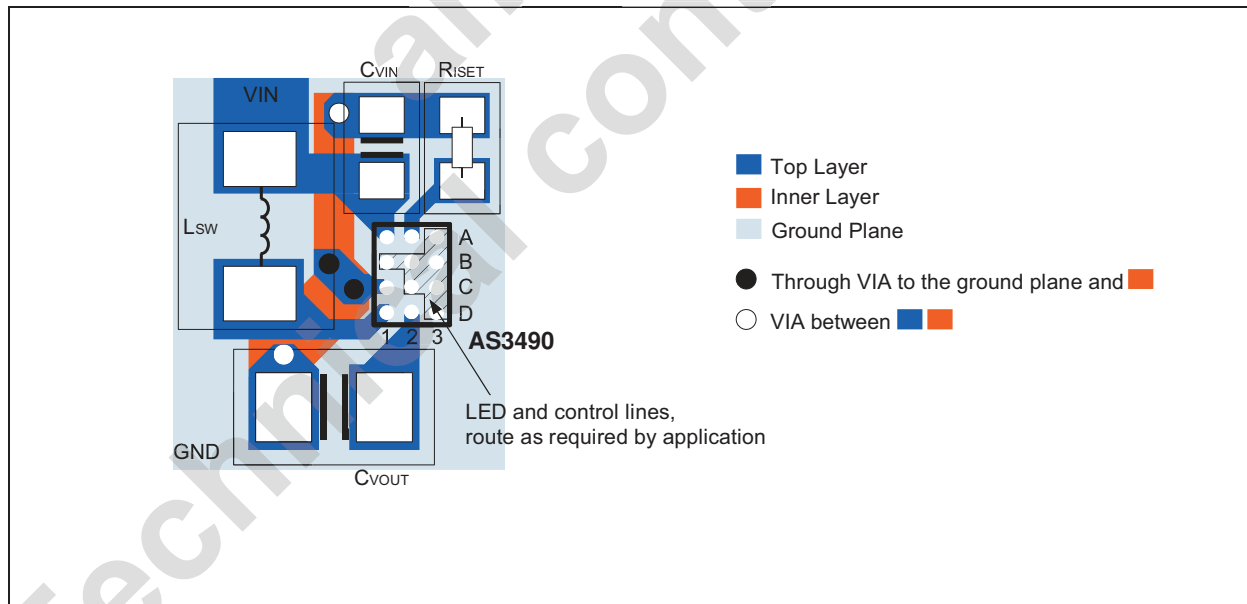

**Note:** If component placement rules allow, move all components close to the AS3490 to reduce the area and length of Loop1 and Loop2

# 10 Package Drawings and Markings

Figure 21. 12pin WL-CSP12 1.7x1.4x0.5mm Marking

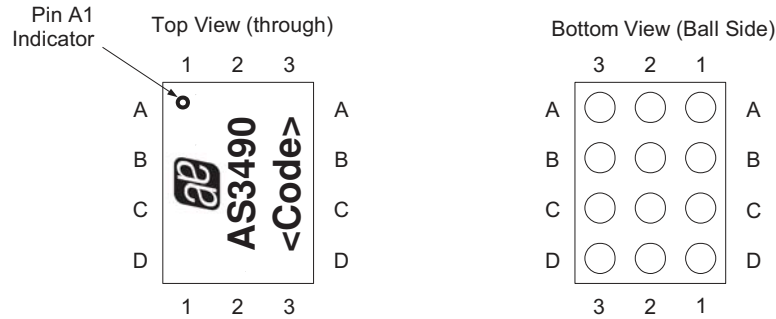

**Note:**

- Line 1: austriamicrosystems logo
- Line 2: AS3490
- Line 3: <Code>  
Encoded Datecode (4 characters)

Figure 22. 12pin WL-CSP12 1.7x1.4x0.5mm Package Dimensions

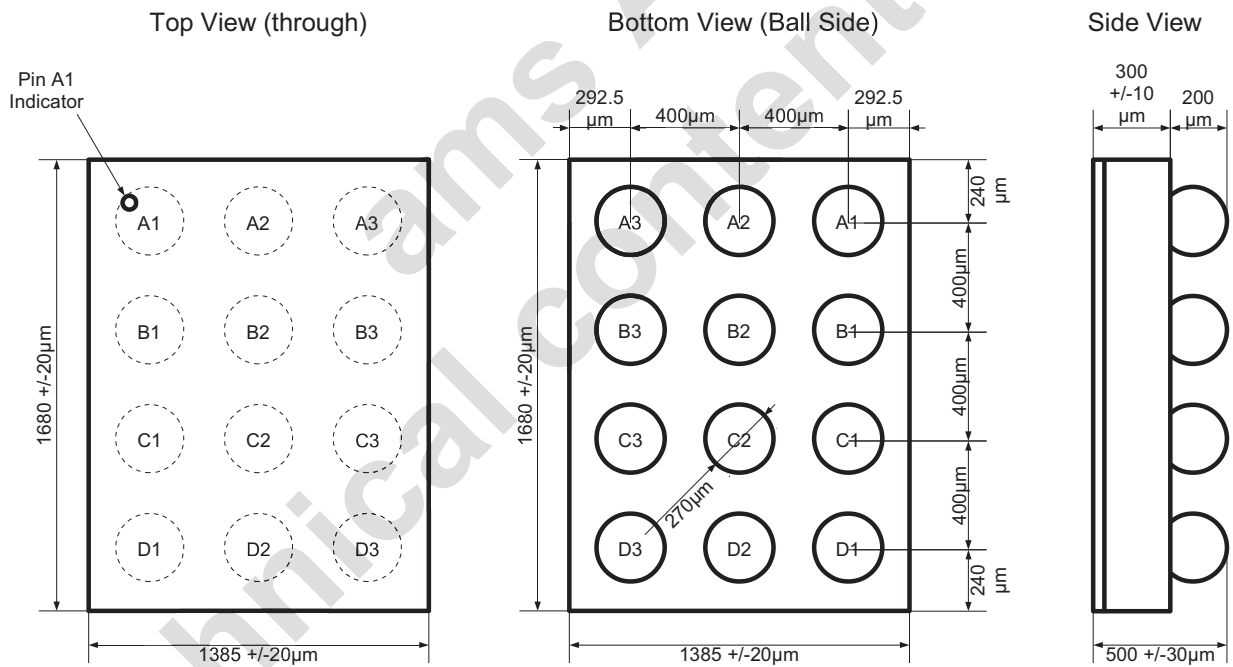

The coplanarity of the balls is 40µm.



## 11 Ordering Information

The devices are available as the standard products shown in [Table 7](#).

Table 7. Ordering Information

| Model       | Description   | Delivery Form | Package  |
|-------------|---|---------------|--|
| AS3490-ZWLT | Highly Efficient 2-6 LEDs Backlight Driver with PWM Input | Tape & Reel   | 12-pin WL-CSP<br>(1.7x1.4x0.5mm)<br>RoHS compliant / Pb-Free / Green |

**Note:** All products are RoHS compliant and austriamicrosystems green.

Buy our products or get free samples online at ICdirect: <http://www.austriamicrosystems.com/ICdirect>

Technical support is found at <http://www.austriamicrosystems.com/Technical-Support>

For further information and requests, please contact us <mailto:sales@austriamicrosystems.com>

or find your local distributor at <http://www.austriamicrosystems.com/distributor>

**Note:** AS3490-ZWLT

AS3490-

Z Temperature Range: -30°C - 85°C

WL Wafer Level Chip Scale Package (WL-CSP) 1.7x1.4x0.5mm

T Delivery Form: Tape & Reel

## Copyrights

Copyright © 1997-2012, austriamicrosystems AG, Schloss Premstaetten, 8141 Unterpremstaetten, Austria-Europe. Trademarks Registered ®. All rights reserved. The material herein may not be reproduced, adapted, merged, translated, stored, or used without the prior written consent of the copyright owner.

All products and companies mentioned are trademarks or registered trademarks of their respective companies.

## Disclaimer

Devices sold by austriamicrosystems AG are covered by the warranty and patent indemnification provisions appearing in its Term of Sale. austriamicrosystems AG makes no warranty, express, statutory, implied, or by description regarding the information set forth herein or regarding the freedom of the described devices from patent infringement. austriamicrosystems AG reserves the right to change specifications and prices at any time and without notice. Therefore, prior to designing this product into a system, it is necessary to check with austriamicrosystems AG for current information. This product is intended for use in normal commercial applications. Applications requiring extended temperature range, unusual environmental requirements, or high reliability applications, such as military, medical life-support or life-sustaining equipment are specifically not recommended without additional processing by austriamicrosystems AG for each application. For shipments of less than 100 parts the manufacturing flow might show deviations from the standard production flow, such as test flow or test location.

The information furnished here by austriamicrosystems AG is believed to be correct and accurate. However, austriamicrosystems AG shall not be liable to recipient or any third party for any damages, including but not limited to personal injury, property damage, loss of profits, loss of use, interruption of business or indirect, special, incidental or consequential damages, of any kind, in connection with or arising out of the furnishing, performance or use of the technical data herein. No obligation or liability to recipient or any third party shall arise or flow out of austriamicrosystems AG rendering of technical or other services.



## Contact Information

### Headquarters

austriamicrosystems AG

Tobelbaderstrasse 30

Schloss Premstaetten

A-8141 Austria

Tel: +43 (0) 3136 500 0

Fax: +43 (0) 3136 525 01

For Sales Offices, Distributors and Representatives, please visit:

<http://www.austriamicrosystems.com/contact>