

### DESCRIPTION

The MP8104 is a rail-to-rail output, operational amplifier in a TSOT-23 package with industry standard pin-out. This amplifier provides 400KHz bandwidth while consuming an incredibly low 11 $\mu$ A of supply current. The MP8104 can operate with a single supply voltage as low as 1.8V.

### FEATURES

- Single Supply Operation: 1.8V to 5.5V
- TSOT23-5 Package
- 400KHz Gain Bandwidth
- 11 $\mu$ A Supply Current
- Rail-to-Rail Output
- Unity-Gain Stable
- Input Common Mode to Ground
- Drives Up to 1000pF of Capacitive Loads

### APPLICATIONS

- Portable Equipment
- PDAs
- Pagers
- Cordless Phones
- Handheld GPS
- Consumer Electronics

"MPS" and "The Future of Analog IC Technology" are Registered Trademarks of Monolithic Power Systems, Inc.

### TYPICAL APPLICATION

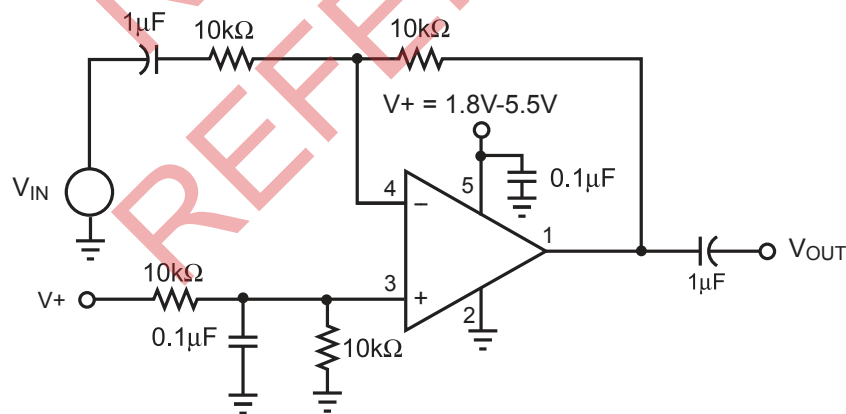

### PACKAGE REFERENCE

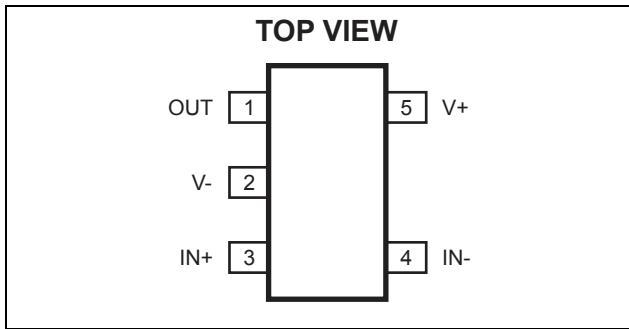

Part Number*	Package	Temperature
MP8104DJ	TSOT23-5	-40°C to +85°C

\* For Tape & Reel, add suffix -Z (eg. MP8104DJ-Z)  
 For Lead Free, add suffix -LF (eg. MP8104DJ-LF-Z)

### ABSOLUTE MAXIMUM RATINGS <sup>(1)</sup>

Supply Voltage (V+ to V-) ..... +6.0V  
 Differential Input Voltage ( $V_{IN+} - V_{IN-}$ ) ..... +6.0V  
 Input Voltage ( $V_{IN+} - V_{IN-}$ )..  $V_{IN+} + 0.3V$ ,  $V_{IN-} - 0.3V$

### Recommended Operating Conditions <sup>(2)</sup>

Supply Voltage ..... +1.8V to +5.5V  
 Operating Temperature ..... -40°C to +85°C

**Thermal Resistance <sup>(3)</sup>**       $\theta_{JA}$        $\theta_{JC}$

TSOT23-5.....	220 ....	110..	°C/W
---------------	----------	-------	------

**Notes:**

- 1) Exceeding these ratings may damage the device.
- 2) The device is not guaranteed to function outside of its operating conditions.
- 3) Measured on approximately 1" square of 1 oz copper.

### ELECTRICAL CHARACTERISTICS

**V+ = +5V, V- = 0V, V<sub>CM</sub> = V+/2, R<sub>L</sub> = 10kΩ, T<sub>A</sub> = +25°C, unless otherwise noted.**

Parameter	Symbol	Condition	Min	Typ	Max	Units
Input Offset Voltage	$V_{OS}$		-5	1	+5	mV
Input Offset Voltage Temp Coefficient				15		$\mu V/^\circ C$
Input Bias Current <sup>(4)</sup>	$I_B$			2		pA
Input Offset Current <sup>(4)</sup>	$I_{OS}$			0.2		pA
Input Voltage Range	$V_{CM}$	CMRR > 60dB	0		3.8	V
Common-Mode Rejection Ratio	CMRR	$0 < V_{CM} < 3.5V$		82		dB
Power Supply Rejection Ratio	PSRR	Supply Voltage change of 1.0V		80		dB
Large Signal Voltage Gain	$A_{VOL}$	$R_L = 100k\Omega$ , $V_{OUT} = 5.0$ Peak to Peak	60	88		dB
Maximum Output Voltage Swing	$V_{OUT}$	$R_L = 10k\Omega$		$(V+) - 23mV$		V
Minimum Output Voltage Swing	$V_{OUT}$	$R_L = 10k\Omega$		$(V-) + 19mV$		V
Gain-Bandwidth Product <sup>(4)</sup>	GBW	$R_L = 200k\Omega, C_L = 2pF$ , $V_{OUT} = 0$		400		KHz
-3dB Bandwidth <sup>(4)</sup>	BW	$A_V = 1, C_L = 2pF$ , $R_L = 1M\Omega$		1		MHz
Slew Rate <sup>(4)</sup>	SR	$A_V = 1, C_L = 2pF$ , $R_L = 1M\Omega$		0.2		V/ $\mu s$
Short Circuit Current	$I_{SC}$	Source		20		mA
		Sink		20		mA
Supply Current		No Load		11	20	$\mu A$

**Note:**

4) Guaranteed by design.

## PIN FUNCTIONS

Pin #	Name	Description
1	OUT	Output.
2	V-	Ground or Supply Return Pin.
3	IN+	Non-Inverting Input.
4	IN-	Inverting Input.
5	V+	Supply Voltage.

## TEST CIRCUITS

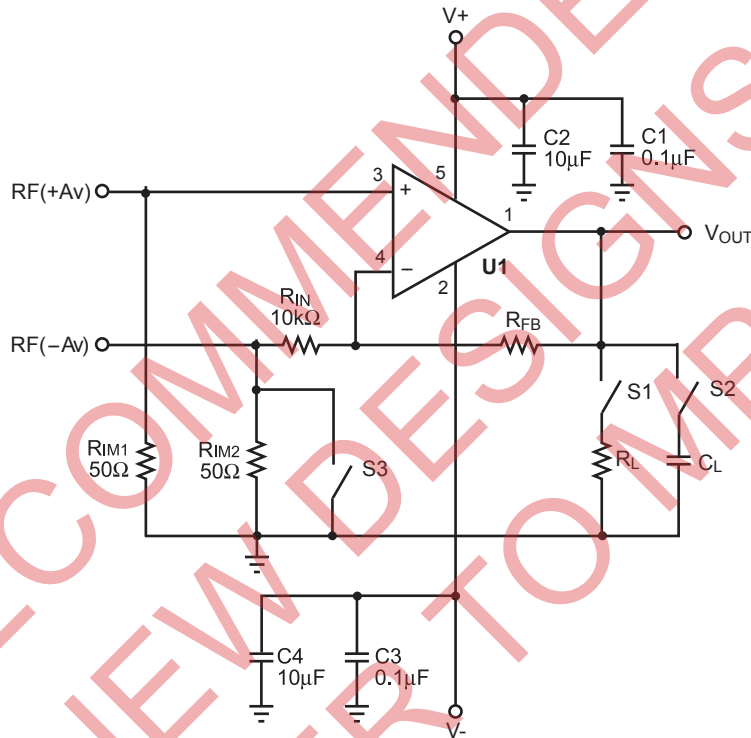

Notes: Close S3 for positive gain. Input signal to RF(+Av) connector.  
 The gain  $A_v = 1 + R_{FB}/R_{IN}$ .  
 For unity gain, remove  $R_{IN}$  and short  $R_{FB}$ .  
 Open S3 for negative gain. Input signal to RF(-Av) connector.  
 The gain  $A_v = -R_{FB}/R_{IN}$ .  
 S1 and S2 are switches for possible resistor and capacitor load connections.

**Figure 1—AC Test Circuit**

**TEST CIRCUITS** *(continued)*

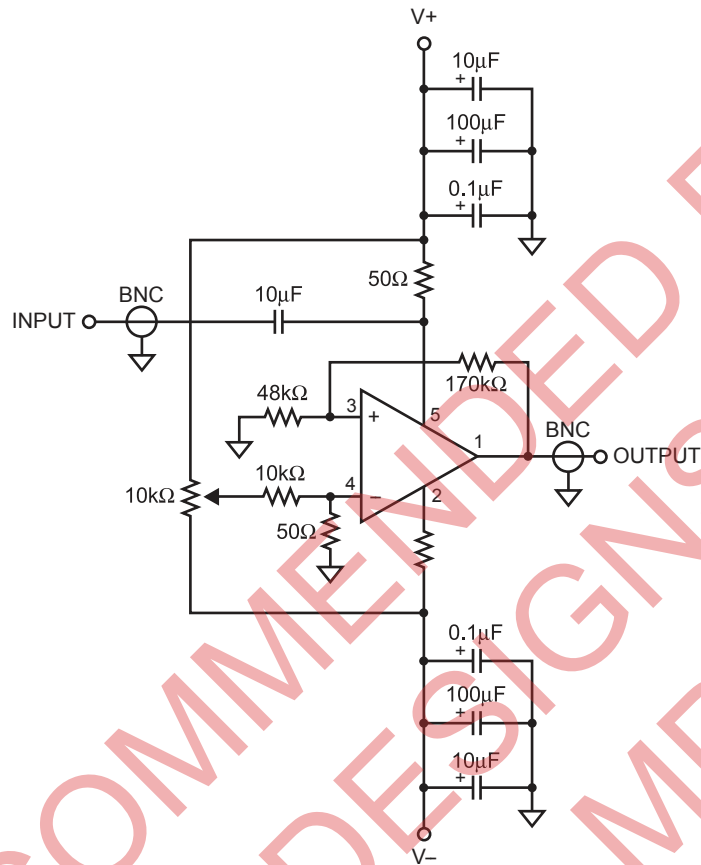
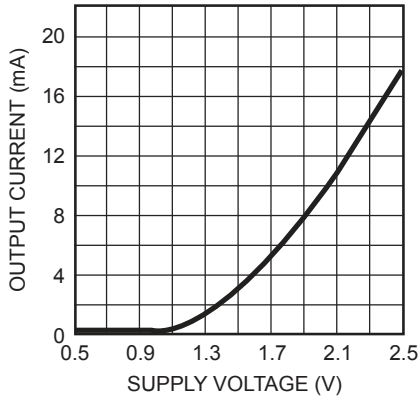

**Figure 2—Positive Power Supply Rejection Ratio Measurement**

## TYPICAL PERFORMANCE CHARACTERISTICS

T<sub>A</sub> = +25°C, unless otherwise noted.

**Short Circuit Current vs Supply Voltage**  
Sourcing



**Short Circuit Current vs Supply Voltage**  
Sinking

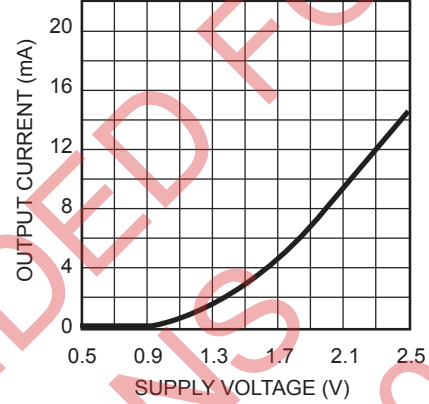

**Offset Voltage vs. Common Mode Voltage**

R<sub>FB</sub> = 50kΩ, V<sub>-</sub> = -5V to 0V, V<sub>+</sub> = 0V to +5V

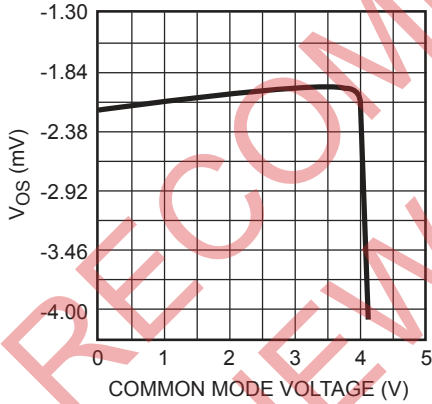

**Offset Voltage vs. Supply Voltage**

R<sub>FB</sub> = 50kΩ, V<sub>-</sub> = -2.5V to 0V, V<sub>+</sub> = +2.5V to 0V

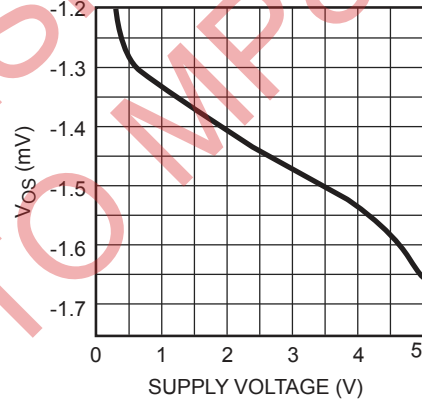

**Output Noise vs. Frequency**

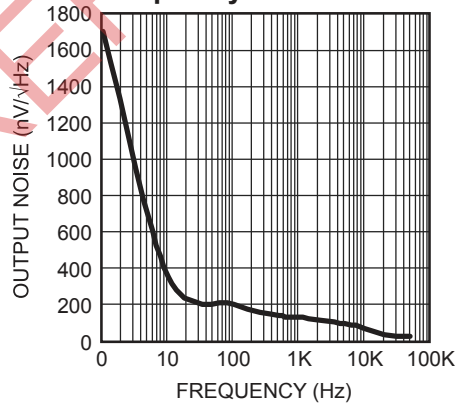

## TYPICAL PERFORMANCE CHARACTERISTICS (continued)

T<sub>A</sub> = +25°C, unless otherwise noted.

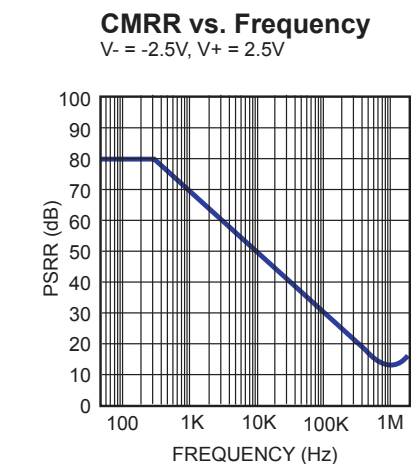
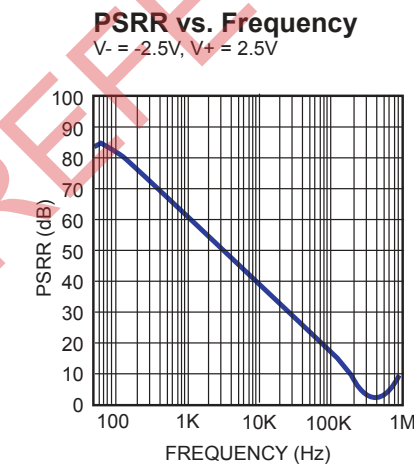
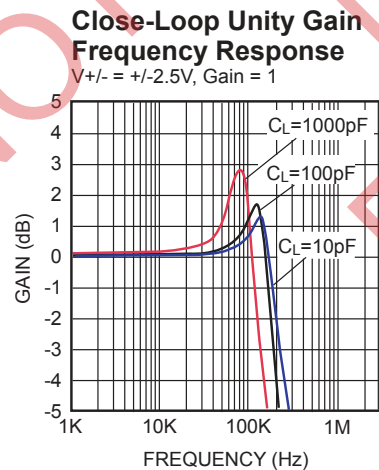
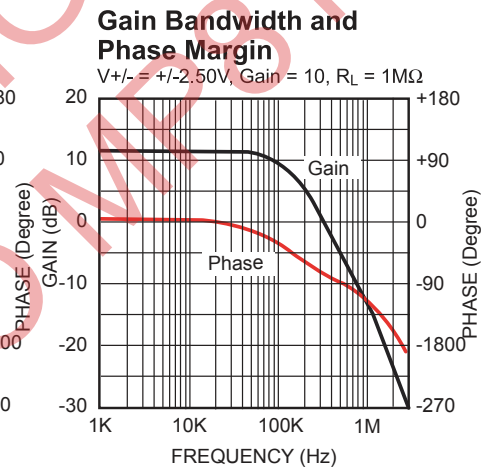
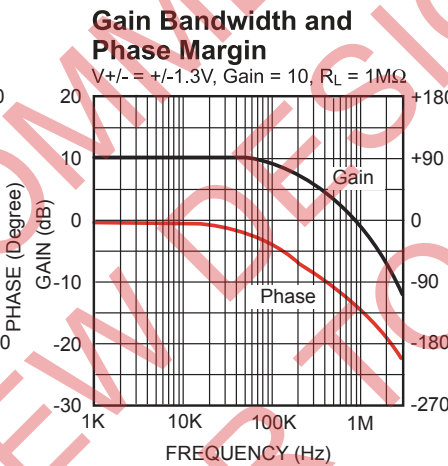
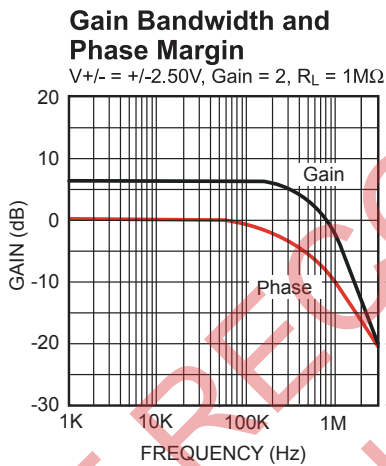
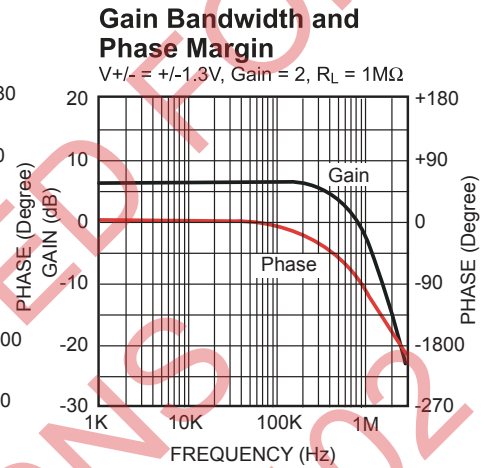
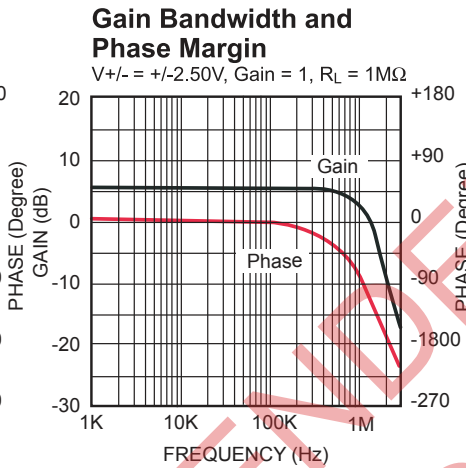
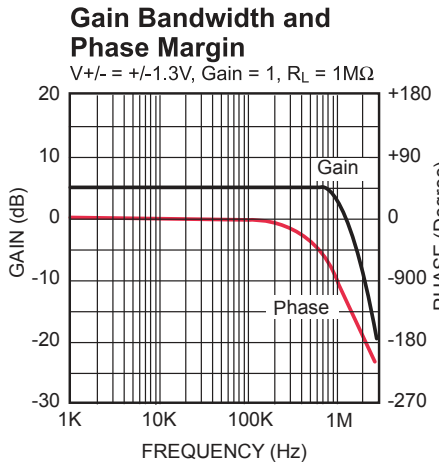

**TYPICAL PERFORMANCE CHARACTERISTICS** *(continued)*
 $T_A = +25^{\circ}\text{C}$ , unless otherwise noted.

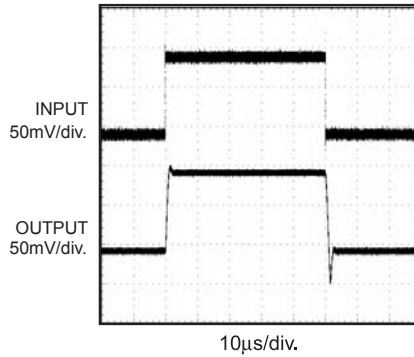
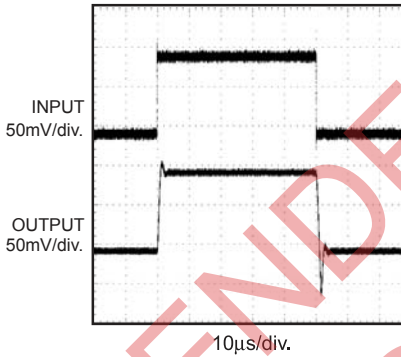
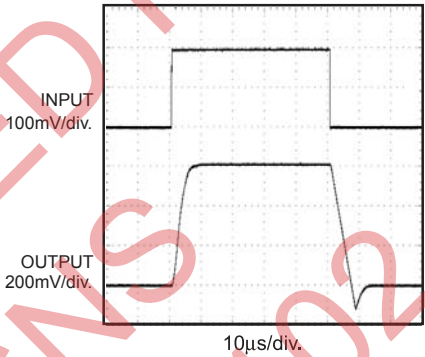
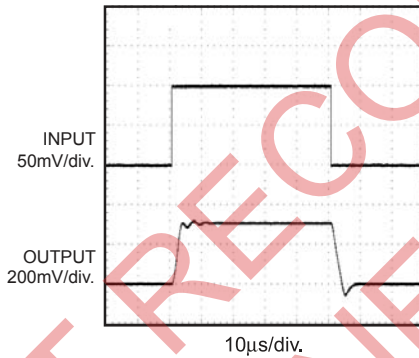
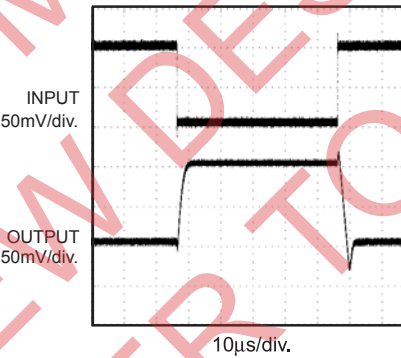
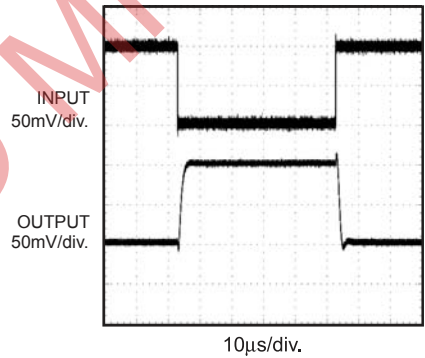
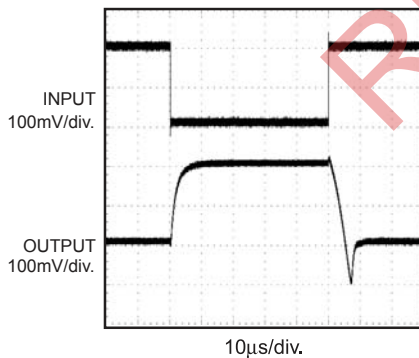
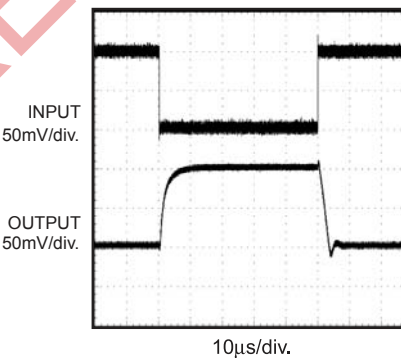
**Small Signal Pulse Response**
 $A_V = 1, V_+ = 2.5\text{V}, V_- = -2.5\text{V}$   
 $R_L = 1\text{M}\Omega, C_L = 8\text{pF}$ 

**Small Signal Pulse Response**
 $A_V = 1, V_+ = 1.3\text{V}, V_- = -1.3\text{V}$   
 $R_L = 1\text{M}\Omega, C_L = 8\text{pF}$ 

**Small Signal Pulse Response**
 $A_V = 1, V_+ = 2.5\text{V}, V_- = -2.5\text{V}$   
 $R_L = 1\text{M}\Omega, C_L = 47\text{pF}$ 

**Small Signal Pulse Response**
 $A_V = 1, V_+ = 1.3\text{V}, V_- = -1.3\text{V}$   
 $R_L = 1\text{M}\Omega, C_L = 47\text{pF}$ 

**Small Signal Pulse Response**
 $A_V = -1, V_+ = 2.5\text{V}, V_- = -2.5\text{V}$   
 $R_L = 1\text{M}\Omega, C_L = 8\text{pF}$ 

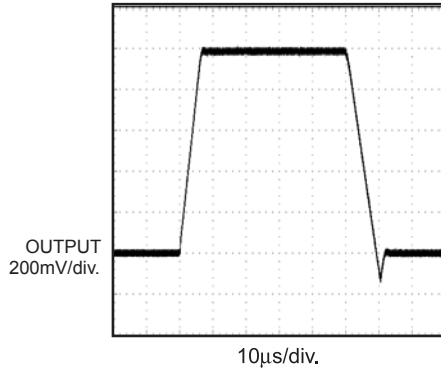
**Small Signal Pulse Response**
 $A_V = -1, V_+ = 1.3\text{V}, V_- = -1.3\text{V}$   
 $R_L = 1\text{M}\Omega, C_L = 8\text{pF}$ 

**Small Signal Pulse Response**
 $A_V = -1, V_+ = 2.5\text{V}, V_- = -2.5\text{V}$   
 $R_L = 4.7\text{k}\Omega, C_L = 8\text{pF}$ 

**Small Signal Pulse Response**
 $A_V = -1, V_+ = 1.3\text{V}, V_- = -1.3\text{V}$   
 $R_L = 4.7\text{k}\Omega, C_L = 8\text{pF}$ 

## TYPICAL PERFORMANCE CHARACTERISTICS *(continued)*

$T_A = +25^\circ\text{C}$ , unless otherwise noted.

### Large Signal Pulse Response

$A_V = 1$ ,  $V_+ = 2.5\text{V}$ ,  $V_- = -2.5\text{V}$   
 $R_L = 1\text{M}\Omega$ ,  $C_L = 8\text{pF}$



### Large Signal Pulse Response

$A_V = 1$ ,  $V_+ = 1.3\text{V}$ ,  $V_- = -1.3\text{V}$   
 $R_L = 1\text{M}\Omega$ ,  $C_L = 8\text{pF}$

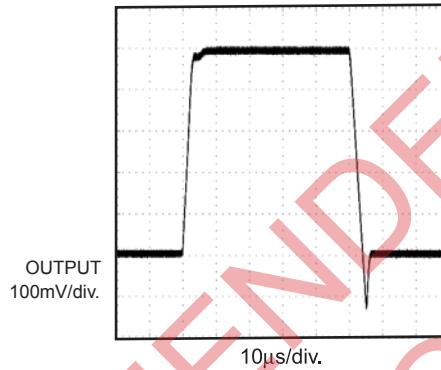

### Rail to Rail Output Operation

$A_V = -2$ ,  $V_+ = 2.5\text{V}$ ,  $V_- = -2.5\text{V}$   
 $R_L = 1\text{M}\Omega$ ,  $C_L = 50\text{pF}$

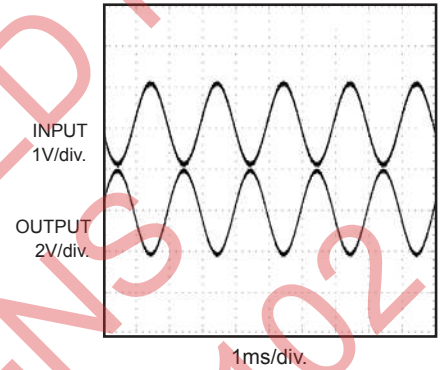

### Rail to Rail Output Operation

$A_V = -2$ ,  $V_+ = 1.3\text{V}$ ,  $V_- = -1.3\text{V}$   
 $R_L = 1\text{M}\Omega$ ,  $C_L = 50\text{pF}$

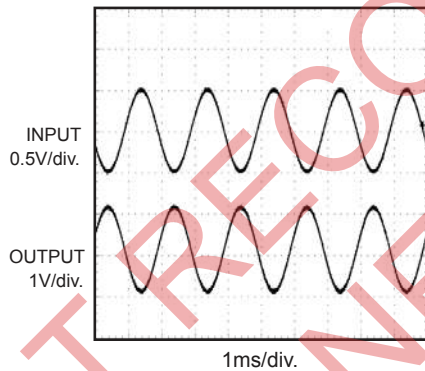

### Rail to Rail Output Operation

$A_V = 2$ ,  $V_+ = 2.5\text{V}$ ,  $V_- = -2.5\text{V}$   
 $R_L = 1\text{M}\Omega$ ,  $C_L = 8\text{pF}$

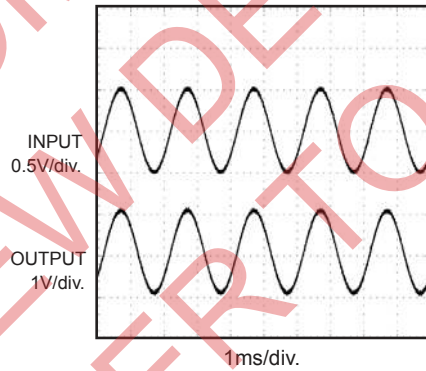

### Rail to Rail Output Operation

$A_V = 2$ ,  $V_+ = 1.3\text{V}$ ,  $V_- = -1.3\text{V}$   
 $R_L = 1\text{M}\Omega$ ,  $C_L = 8\text{pF}$

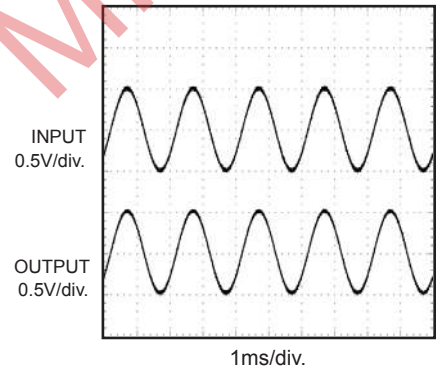



## APPLICATION INFORMATION

### Power Supply Bypassing

Regular supply bypassing techniques are recommended. A  $10\mu\text{F}$  capacitor in parallel with a  $0.1\mu\text{F}$  capacitor on both the positive and negative supplies is ideal. For the best performance, all bypassing capacitors should

be located as close to the op amp as possible and all capacitors should be low ESL (Equivalent Series Inductance) and low ESR (Equivalent Series Resistance). Surface mount ceramic capacitors are ideal.

## TYPICAL APPLICATION CIRCUIT

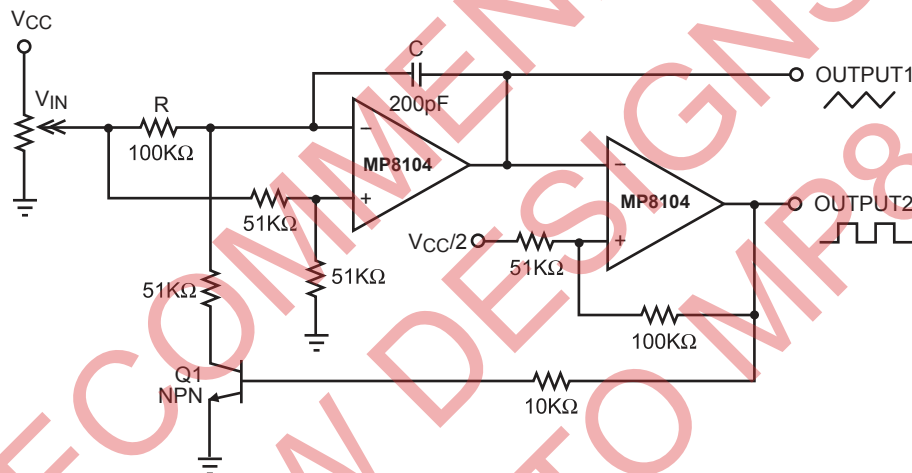

Notes:

- 1) The control voltage  $V_{IN}$  is wide,  $0 < V_{IN} < V_{CC} - 1V$
- 2) The switch frequency can be changed by adjusting R and C.

**Figure 3—Voltage Controlled Frequency Circuit**

## PACKAGE INFORMATION

### TSOT23-5

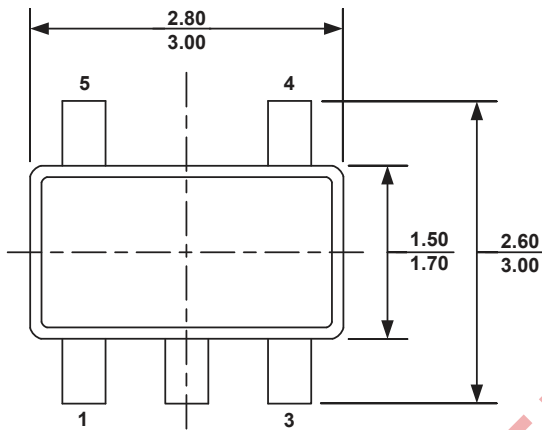

**TOP VIEW**

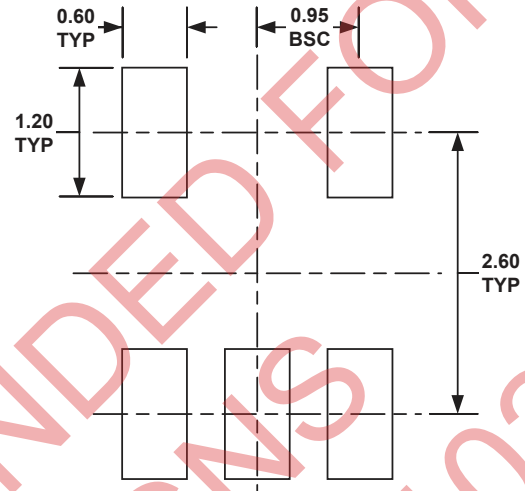

**RECOMMENDED LAND PATTERN**

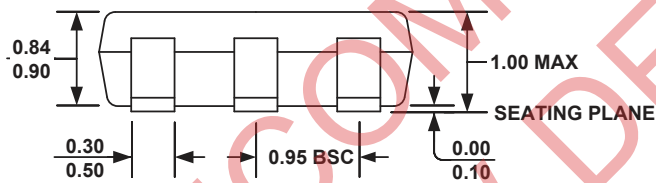

**FRONT VIEW**

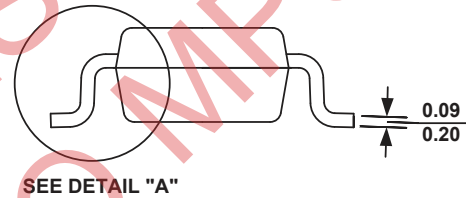

**SIDE VIEW**

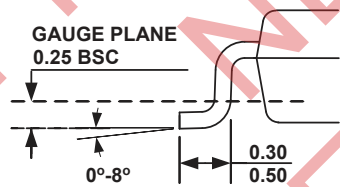

**DETAIL A**

**NOTE:**

- 1) ALL DIMENSIONS ARE IN MILLIMETERS.
- 2) PACKAGE LENGTH DOES NOT INCLUDE MOLD FLASH, PROTRUSION OR GATE BURR.
- 3) PACKAGE WIDTH DOES NOT INCLUDE INTERLEAD FLASH OR PROTRUSION.
- 4) LEAD COPLANARITY (BOTTOM OF LEADS AFTER FORMING) SHALL BE 0.10 MILLIMETERS MAX.
- 5) DRAWING CONFORMS TO JEDEC MO-193, VARIATION AA.
- 6) DRAWING IS NOT TO SCALE.

**NOTICE:** The information in this document is subject to change without notice. Users should warrant and guarantee that third party Intellectual Property rights are not infringed upon when integrating MPS products into any application. MPS will not assume any legal responsibility for any said applications.