

Mechanical Dimensions: Inches [mm]

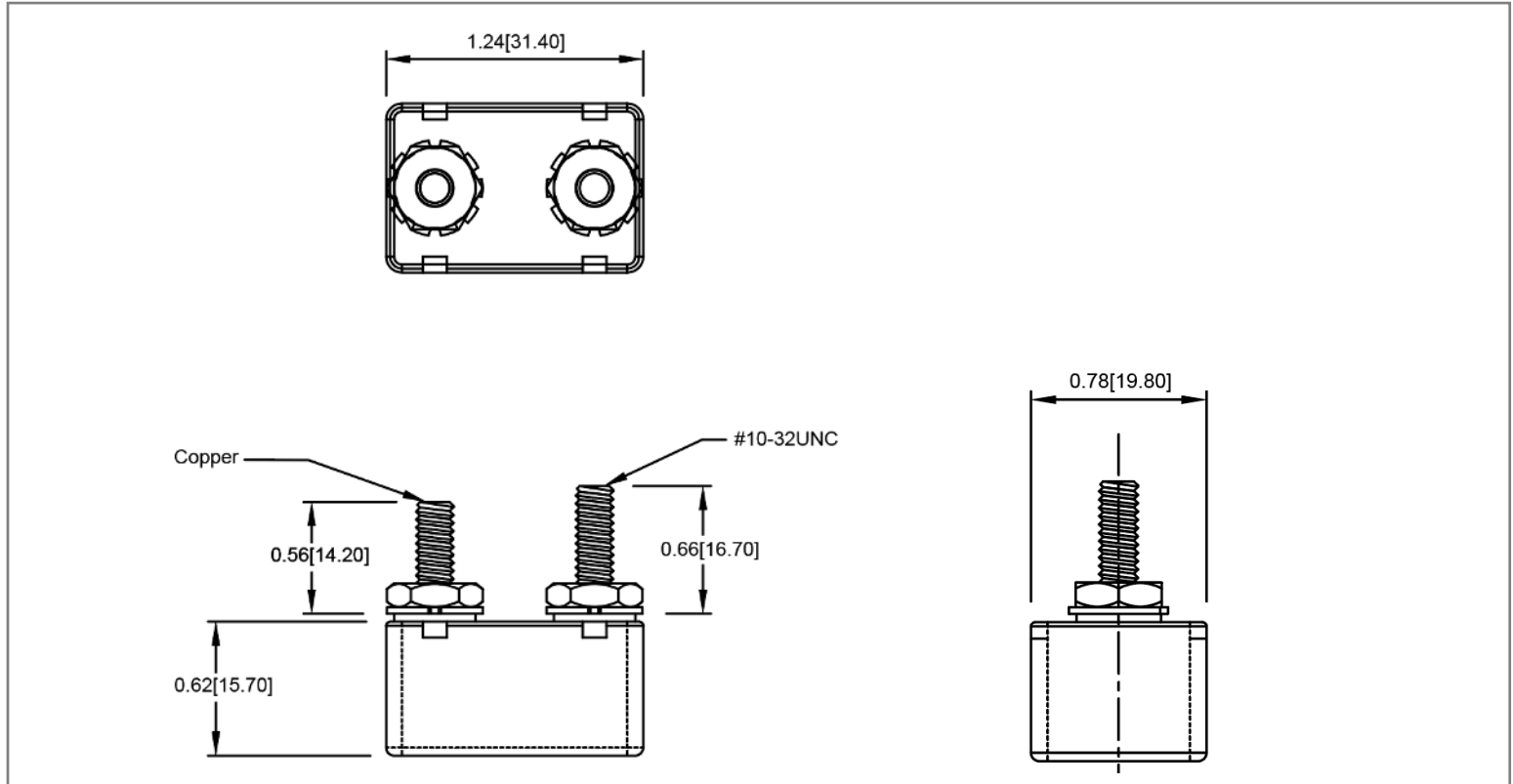

Part Numbers Information

Optifuse P/N	Current
MOCB-12-N-10A	10A
MOCB-12-N-15A	15A
MOCB-12-N-20A	20A
MOCB-12-N-25A	25A
MOCB-12-N-30A	30A
MOCB-12-N-40A	40A
MOCB-12-N-50A	50A

Time vs. Percent of Rated Current

% of Rated Current	Min Trip Time	Max Trip Time
100%	30m	-
135%	-	30m
200%	-	1m

Electrical Specifications

Voltage	12VDC
Reset Type	Type II - Modified Reset
Operation Temperature	-40° F ~ 175° F
Compliances	SAE J553

Material Specification

Body Material	Plated Steel
Terminals Material	Battery – Copper, Auxiliary – Zinc
Terminals Configuration	#10-32 Stud
Mounting Type	Stud Mounted

Rev **Date of issue** **Revision Notes**

Designed **Approved**

A	06-25-2020	Initial Drawing	RC	OF
---	------------	-----------------	----	----