

GloTek, Inc. www.globtek.com 186 Veterans Drive, Northvale, NJ 07647 Tel. (201) 784-1000 Fax (201) 784-0111	Drawing Title: MOLEX HOUSING 2.54MM PITCH 4 CIRCUIT Molex:22-01-2047 WITH TERMINALS 08-50-0114 NO SUBSTITUTE to MOLEX HOUSING 43025-0400 WITH TERMINALS 43030-0038 NO SUBSTITUTE, GT Cable #4*UL1007 22AWG WIRE, 2 BLACK, 2 RED: 22 / 4 Conductors, 1.6mm OD, UL1007, 80 Deg.C, 300V, 2 RED, 2 BLACK, Approvals: , 230mm,	
	Model No. Low voltage cable	Part No./Ordering No. MLX410070M23MLX2X2(R)
		Rev B

CUSTOMIZED LENGTHS, COLORS, CABLE TYPES, TERMINATIONS/PLUGS/RECEPTACLES AVAILABLE UPON REQUEST. ADDITIONAL PLUG OPTIONS ARE AVAILABLE AT <https://www.globtek.com/connectors/> STANDARD PLUGS AND CONNECTORS CAN BE SEEN ONLINE AT <https://www.globtek.com/connectors/> ACTUAL CONNECTORS, OVERMOLDS, FERRITES MAY VARY SLIGHTLY FROM THE PICTURE BELOW DIMENSIONS ARE IN MM UNLESS SPECIFIED OTHERWISE

In Addition to GlobTek Inc.'s renewed ISO9001:2008 - Quality Management System Certification, GlobTek Inc. is now certified to:

ISO13485:2003 - Medical Devices Quality Management System Certification
ISO14001:2004 - Environmental Management System Certification

ISO Certificates are available online at <https://www.globtek.com/iso-certificates/>
Prop 65 Statement:<https://en.globtek.com/prop-65-statement.pdf>

The acceptance of this specification and use of the product described in this document indicates the acceptance and binding of the customer to Globtek TERMS AND CONDITIONS (attached to the end of this document), which supersede all other agreements, terms, and conditions (<https://en.globtek.com/terms-and-conditions/>).

The purchaser of this product (Customer) agrees that it is their sole responsibility to determine suitability/fitness of the product described in this specification for their application and to take precautions for protection against any hazards attendant to the handling and use of the product.

Footnote:

GlobTek Inc. will not be liable for the safety and performance of these power supplies if unauthorized access and repair occurs. End user should consult applicable UL, CSA or EN standards for proper installation instruction.

Limitation of Use:

GlobTek products are intended for use with commercial, medical, and/or industrial equipment only. GlobTek product are not authorized for use as mission critical components in life support hazardous environment, nuclear or aircraft applications without prior written approval from the CEO of GlobTek Inc.
Contents of this document are subject to change without prior notice.

Customer Approval of Specification:

Please approve, sign and send back to GlobTek so we can complete order processing.
A delay in receipt of this form will delay delivery schedule.

Company Name: _____	Customer P/N: _____
Quote Number: _____	Date: _____
Authorized Representative Name: _____	Authorized Representative Signature: _____

GlobTek, Inc. www.globtek.com 186 Veterans Drive, Northvale, NJ 07647 Tel. (201) 784-1000 Fax (201) 784-0111	Drawing Title: MOLEX HOUSING 2.54MM PITCH 4 CIRCUIT Molex:22-01-2047 WITH TERMINALS 08-50-0114 NO SUBSTITUTE to MOLEX HOUSING 43025-0400 WITH TERMINALS 43030-0038 NO SUBSTITUTE. GT Cable #4*UL1007 22AWG WIRE, 2 BLACK, 2 RED: 22 / 4 Conductors, 1.6mm OD, UL1007, 80 Deg.C, 300V, 2 RED, 2 BLACK, Approvals: , 230mm,	
	Model No. Low voltage cable	
Part No./Ordering No. MLX410070M23MLX2X2(R)		Rev B

CUSTOMIZED LENGTHS, COLORS, CABLE TYPES, TERMINATIONS/PLUGS/RECEPTACLES AVAILABLE UPON REQUEST. ADDITIONAL PLUG OPTIONS ARE AVAILABLE AT <https://www.globtek.com/connectors/> STANDARD PLUGS AND CONNECTORS CAN BE SEEN ONLINE AT <https://www.globtek.com/connectors/> ACTUAL CONNECTORS, OVERMOLDS, FERRITES MAY VARY SLIGHTLY FROM THE PICTURE BELOW DIMENSIONS ARE IN MM UNLESS SPECIFIED OTHERWISE

REVISION HISTORY

REV	DESCRIPTION	SUB	DATE	APPROVED
B	Update wire AWG from 18AWG to 22AWG. Remove 'EQUIVALENT' from connector A and connector B description.	svlas	11/27/2019	QA
A	Initial Release	bsiep	09/18/2019	QA

Cordset Information:

CordsetColor:

Cord Length (mm):230

NOTES:

END B MATES TO GTM43007-A, GTM91120, GTM41080, AND GTM21096 OPEN FRAME OUTPUT CONNECTOR

GlobTek, Inc. www.globtek.com 186 Veterans Drive, Northvale, NJ 07647 Tel. (201) 784-1000 Fax (201) 784-0111	Drawing Title: MOLEX HOUSING 2.54MM PITCH 4 CIRCUIT Molex:22-01-2047 WITH TERMINALS 08-50-0114 NO SUBSTITUTE to MOLEX HOUSING 43025-0400 WITH TERMINALS 43030-0038 NO SUBSTITUTE. GT Cable #4*UL1007 22AWG WIRE, 2 BLACK, 2 RED: 22 / 4 Conductors, 1.6mm OD, UL1007, 80 Deg.C, 300V, 2 RED, 2 BLACK, Approvals: , 230mm,	
	Model No. Low voltage cable	Part No./Ordering No. MLX410070M23MLX2X2(R)
		Rev B

CUSTOMIZED LENGTHS, COLORS, CABLE TYPES, TERMINATIONS/PLUGS/RECEPTACLES AVAILABLE UPON REQUEST. ADDITIONAL PLUG OPTIONS ARE AVAILABLE AT <https://www.globtek.com/connectors/> STANDARD PLUGS AND CONNECTORS CAN BE SEEN ONLINE AT <https://www.globtek.com/connectors/> ACTUAL CONNECTORS, OVERMOLDS, FERRITES MAY VARY SLIGHTLY FROM THE PICTURE BELOW DIMENSIONS ARE IN MM UNLESS SPECIFIED OTHERWISE

END A

END B

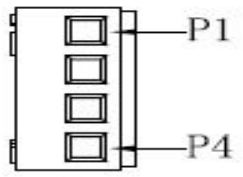
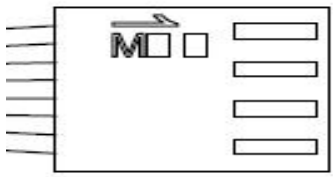

Front View

Mates with: 22232041, 22272041, 470531000, 22053041, 22112042, 22122044, 22032041, 22052041, 1718570004, 22102041, 22292041, 22122041, 22288042, 22284040, 22284041, 22288040, 22288041, 22288043, 22284043, 22284044, 22284042, 22284045, 22284047, 22284048, 22286042, 22284046, 22288044, 22288045

GlobTek, Inc. www.globtek.com 186 Veterans Drive, Northvale, NJ 07647 Tel. (201) 784-1000 Fax (201) 784-0111	Drawing Title: MOLEX HOUSING 2.54MM PITCH 4 CIRCUIT Molex:22-01-2047 WITH TERMINALS 08-50-0114 NO SUBSTITUTE to MOLEX HOUSING 43025-0400 WITH TERMINALS 43030-0038 NO SUBSTITUTE. GT Cable #4*UL1007 22AWG WIRE, 2 BLACK, 2 RED: 22 / 4 Conductors, 1.6mm OD, UL1007, 80 Deg.C, 300V, 2 RED, 2 BLACK, Approvals: , 230mm,	
	Model No. Low voltage cable	Rev B
Part No./Ordering No. MLX410070M23MLX2X2(R)		

CUSTOMIZED LENGTHS, COLORS, CABLE TYPES, TERMINATIONS/PLUGS/RECEPTACLES AVAILABLE UPON REQUEST. ADDITIONAL PLUG OPTIONS ARE AVAILABLE AT <https://www.globtek.com/connectors/> STANDARD PLUGS AND CONNECTORS CAN BE SEEN ONLINE AT <https://www.globtek.com/connectors/> ACTUAL CONNECTORS, OVERMOLDS, FERRITES MAY VARY SLIGHTLY FROM THE PICTURE BELOW DIMENSIONS ARE IN MM UNLESS SPECIFIED OTHERWISE

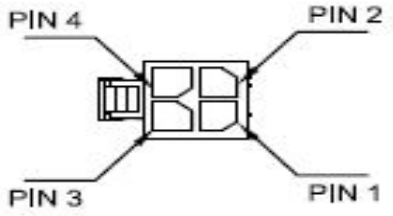
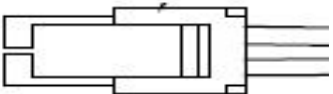

Front View

- Mates with: 430450412, 430200401, 430200400, 430450400,
430450413, 430450409, 430450410, 430450408,
430450421, 430450409, 430450410, 430450408,
430450414, 430450409, 430450411, 430450419,
430450422, 430450423, 430450411, 430450419,
430450418, 430450420, 430450411, 430450419,
430450418, 430450420, 430450425, 430450402,
430450418, 430450410, 430450408, 442420001

GlobTek, Inc. www.globtek.com 186 Veterans Drive, Northvale, NJ 07647 Tel. (201) 784-1000 Fax (201) 784-0111	Drawing Title: MOLEX HOUSING 2.54MM PITCH 4 CIRCUIT Molex:22-01-2047 WITH TERMINALS 08-50-0114 NO SUBSTITUTE to MOLEX HOUSING 43025-0400 WITH TERMINALS 43030-0038 NO SUBSTITUTE. GT Cable #4*UL1007 22AWG WIRE, 2 BLACK, 2 RED: 22 / 4 Conductors, 1.6mm OD, UL1007, 80 Deg.C, 300V, 2 RED, 2 BLACK, Approvals: , 230mm,
	Model No. Low voltage cable
Part No./Ordering No. MLX410070M23MLX2X2(R)	Rev B

CUSTOMIZED LENGTHS, COLORS, CABLE TYPES, TERMINATIONS/PLUGS/RECEPTACLES AVAILABLE UPON REQUEST. ADDITIONAL PLUG OPTIONS ARE AVAILABLE AT <https://www.globtek.com/connectors/> STANDARD PLUGS AND CONNECTORS CAN BE SEEN ONLINE AT <https://www.globtek.com/connectors/> ACTUAL CONNECTORS, OVERMOLDS, FERRITES MAY VARY SLIGHTLY FROM THE PICTURE BELOW DIMENSIONS ARE IN MM UNLESS SPECIFIED OTHERWISE

CABLE IMAGE

Important dimension "*"

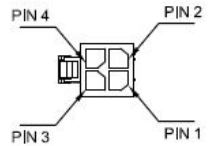
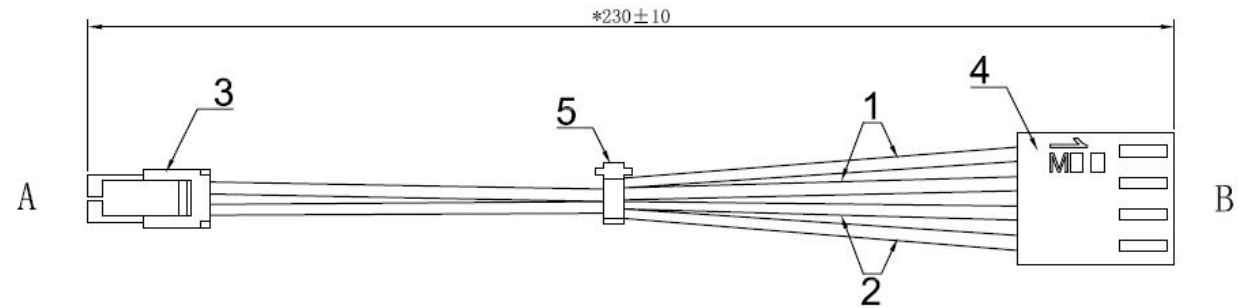

Front View

A	Wire color	B
P2	RED	P1
P4	RED	P2
P1	BLACK	P3
P3	BLACK	P4

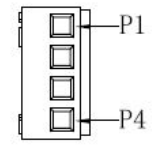

Front View

GlobTek, Inc. www.globtek.com 186 Veterans Drive, Northvale, NJ 07647 Tel. (201) 784-1000 Fax (201) 784-0111	Drawing Title: MOLEX HOUSING 2.54MM PITCH 4 CIRCUIT Molex:22-01-2047 WITH TERMINALS 08-50-0114 NO SUBSTITUTE to MOLEX HOUSING 43025-0400 WITH TERMINALS 43030-0038 NO SUBSTITUTE. GT Cable #4*UL1007 22AWG WIRE, 2 BLACK, 2 RED: 22 / 4 Conductors, 1.6mm OD, UL1007, 80 Deg.C, 300V, 2 RED, 2 BLACK, Approvals: , 230mm,	
	Model No. Low voltage cable	Part No./Ordering No. MLX410070M23MLX2X2(R)

CUSTOMIZED LENGTHS, COLORS, CABLE TYPES, TERMINATIONS/PLUGS/RECEPTACLES AVAILABLE UPON REQUEST. ADDITIONAL PLUG OPTIONS ARE AVAILABLE AT <https://www.globtek.com/connectors/> STANDARD PLUGS AND CONNECTORS CAN BE SEEN ONLINE AT <https://www.globtek.com/connectors/> ACTUAL CONNECTORS, OVERMOLDS, FERRITES MAY VARY SLIGHTLY FROM THE PICTURE BELOW DIMENSIONS ARE IN MM UNLESS SPECIFIED OTHERWISE

End A Code:MLX4 Description:MOLEX HOUSING 2.54MM PITCH 4 CIRCUIT Molex:22-01-2047 WITH TERMINALS 08-50-0114 NO SUBSTITUTE Rating (V):250 Rating (A):7.0 Gender:Female Overmolded:No	Cable Code:4*UL1007 22AWG WIRE, 2 BLACK, 2 RED Description:GT Cable #4*UL1007 22AWG WIRE, 2 BLACK, 2 RED: 22 / 4 Conductors, 1.6mm OD, UL1007, 80 Deg.C, 300V, 2 RED, 2 BLACK, Approvals: Color:GlobTek Black Wire Gauge(AWG):22 Cond:4 Type:UL1007 Temperature:80° C Amps:3 Volts:300 OD:1.6 ConductorsColors:2 RED, 2 BLACK	End B Code:MLX2X2 Description:MOLEX HOUSING 43025-0400 WITH TERMINALS 43030-0038 NO SUBSTITUTE Rating (V):250 Rating (A):5.0 Gender:Female Overmolded:No
---	--	--

Overall cable rating:

Plug Approvals	Cable Approvals	Connector Approvals
----------------	-----------------	---------------------



UL RECOGNIZED

AGENCY ONLINE DOCUMENTS	http://en.globtek.com/cordsets/
RoHS/RoHS3 Declaration	https://www.globtek.com/pdf/rohs_cert/01t3a000004dia4AAA
REACH Declaration	https://www.globtek.com/pdf/iso_certificates/REACH.pdf
Conflict Minerals Declaration	https://www.globtek.com/pdf/conflict-minerals.pdf
Prop 65 Statement	https://en.globtek.com/prop-65-statement.pdf
CE.UKCA.Cord	https://globtek.secure.force.com/spec/ec_decl_product_model_family_incl_cord?id=01t3a000004dia4

IPXY rating is based on 3rd party testing and customers should check suitability and test system level IPXY rating before ordering.

GlobTek, Inc. www.globtek.com 186 Veterans Drive, Northvale, NJ 07647 Tel. (201) 784-1000 Fax (201) 784-0111	Drawing Title: MOLEX HOUSING 2.54MM PITCH 4 CIRCUIT Molex:22-01-2047 WITH TERMINALS 08-50-0114 NO SUBSTITUTE to MOLEX HOUSING 43025-0400 WITH TERMINALS 43030-0038 NO SUBSTITUTE. GT Cable #4*UL1007 22AWG WIRE, 2 BLACK, 2 RED: 22 / 4 Conductors, 1.6mm OD, UL1007, 80 Deg.C, 300V, 2 RED, 2 BLACK, Approvals: , 230mm,	
	Model No. Low voltage cable	Part No./Ordering No. MLX410070M23MLX2X2(R)
		Rev B

CUSTOMIZED LENGTHS, COLORS, CABLE TYPES, TERMINATIONS/PLUGS/RECEPTACLES AVAILABLE UPON REQUEST. ADDITIONAL PLUG OPTIONS ARE AVAILABLE AT <https://www.globtek.com/connectors/> STANDARD PLUGS AND CONNECTORS CAN BE SEEN ONLINE AT <https://www.globtek.com/connectors/> ACTUAL CONNECTORS, OVERMOLDS, FERRITES MAY VARY SLIGHTLY FROM THE PICTURE BELOW DIMENSIONS ARE IN MM UNLESS SPECIFIED OTHERWISE

Hanking:NO HANK
 Description:NO HANK, BULK PACKED
 Image:

Notes/Modifications/Customizations (notes in this section supersede the values shown in the standard spec):