

Low Quiescent Current 500 mA μ Cap LDO Regulator

Features

- Ultra-Low Quiescent Current ($I_Q = 23 \mu\text{A} @ I_O = 100 \mu\text{A}$)
- Continuous 500 mA Output Current
- Wide Input Range: 2.3V to 30V
- Low Dropout Voltage: 350 mV @ 500 mA
- $\pm 1.0\%$ Initial Output Accuracy
- Stable with Ceramic or Tantalum Output Capacitor
- Logic Compatible Enable Input
- Low Output Voltage Error Flag Indicator
- Overcurrent Protection
- Thermal Shutdown
- Reverse-Leakage Protection
- Reverse-Battery Protection
- High-Power SOIC-8, MSOP-8, and SOT-223 Packages

Applications

- USB Power Supply
- Keep-Alive Supply in Notebook and Portable Personal Computers
- Logic Supply from High Voltage Batteries
- Automotive Electronics
- Battery-Powered Systems

General Description

The MIC5239 is a low quiescent current, μ Cap low-dropout regulator. With a maximum operating input voltage of 30V and a quiescent current of 23 μA , it is ideal for supplying keep-alive power in systems with high voltage batteries.

Capable of 500 mA output, the MIC5239 has a dropout voltage of only 350 mV. It can provide high output current for applications such as USB.

As a μ Cap LDO, the MIC5239 is stable with either a ceramic or a tantalum output capacitor. It only requires a 3.3 μF output capacitor for stability.

The MIC5239 includes a logic compatible enable input and an undervoltage error flag indicator. Other features of the MIC5239 include thermal shutdown, current limit, overvoltage shutdown, reverse-leakage protection, and reverse-battery protection.

Available in the thermally enhanced SOIC-8, MSOP-8, and SOT-223, the MIC5239 comes in fixed 1.5V, 1.8V, 2.5V, 3.0V, 3.3V, and 5.0V, and adjustable voltages. For other output voltages, contact Microchip.

Package Types

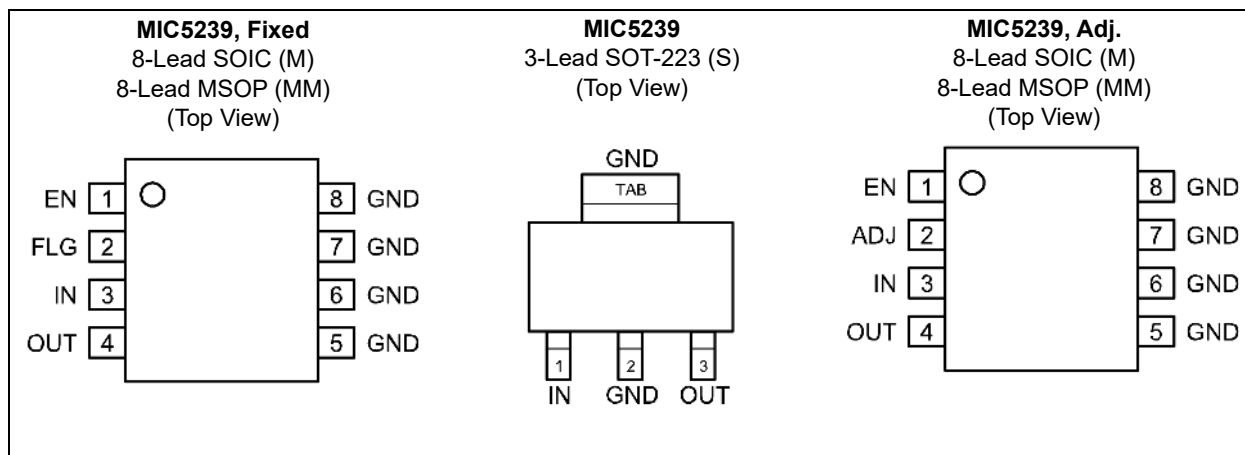

MIC5239

Typical Application Circuit

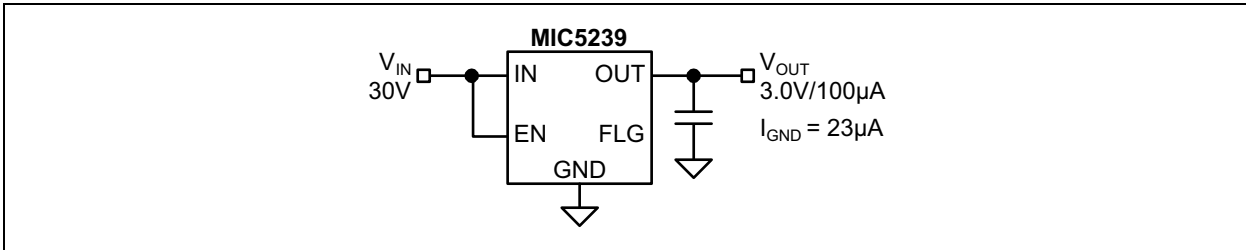

Functional Block Diagram

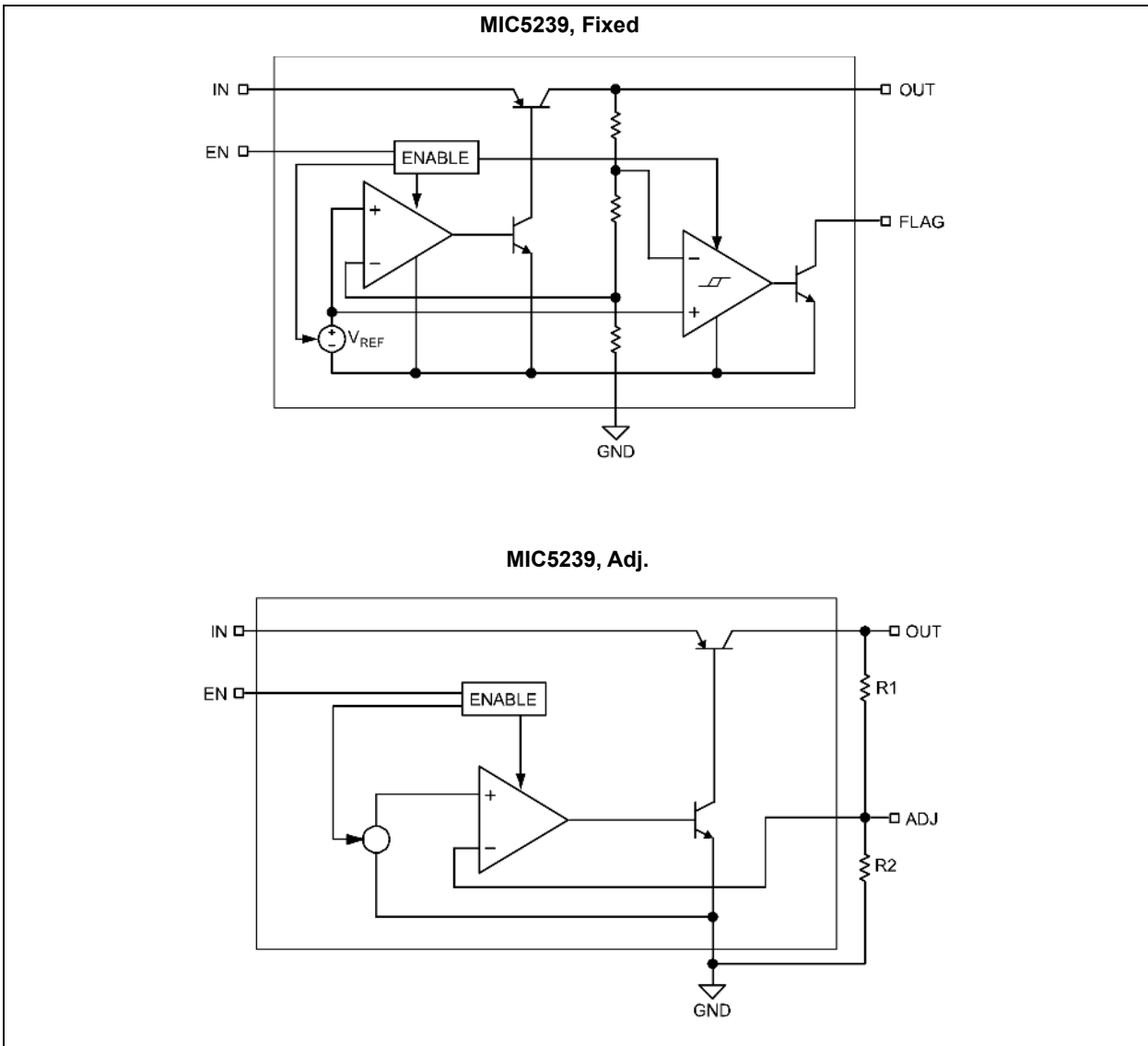

1.0 ELECTRICAL CHARACTERISTICS

Absolute Maximum Ratings †

Supply Voltage (V_{IN})	–20V to +32V
Enable Input Voltage (V_{EN})	–0.3V to +32V
Power Dissipation (P_D) (Note 1)	Internally Limited
ESD Rating (Note 2) (SOT-223)	2 kV
ESD Rating (Note 2) (8-Lead MSOP)	1.5 kV

Operating Ratings ‡

Supply Voltage (V_{IN})	+2.3V to +30V
Enable Input Voltage (V_{EN})	0V to +30V

† **Notice:** Stresses above those listed under “Absolute Maximum Ratings” may cause permanent damage to the device. This is a stress rating only and functional operation of the device at those or any other conditions above those indicated in the operational sections of this specification is not intended. Exposure to maximum rating conditions for extended periods may affect device reliability.

‡ **Notice:** The device is not guaranteed to function outside its operating ratings.

Note 1: The maximum allowable power dissipation of any T_A (ambient temperature) is $P_{D(MAX)} = (T_{J(MAX)} - T_A) \div \theta_{JA}$. Exceeding the maximum allowable power dissipation will result in excessive die temperature, and the regulator will go into thermal shutdown. The θ_{JA} of the MIC5239-x.xYMM (all versions) is 80°C/W, the MIC5239-x.xYM (all versions) is 63°C/W, and the MIC5239-x.xYS (all versions) is 50°C/W mounted on a PC board, see “Thermal Characteristics” for further details.

2: Devices are inherently ESD sensitive. Handling precautions required. Human body model: 1.5 kΩ in series with 100 pF.

ELECTRICAL CHARACTERISTICS

Electrical Characteristics: $V_{IN} = V_{OUT} + 1V$; $V_{EN} \geq 2.0V$; $I_{OUT} = 100 \mu A$; $T_J = +25^\circ C$, **bold** values valid for $-40^\circ C \leq T_J \leq +125^\circ C$; unless noted. (Note 1)

Parameter	Symbol	Min.	Typ.	Max.	Units	Conditions
Output Voltage Accuracy	V_{OUT}	–1	—	1	%	Variation from nominal V_{OUT}
		–2	—	2		
Line Regulation	$\Delta V_{OUT}/V_{OUT}$	—	0.06	0.5	%	$V_{IN} = V_{OUT} + 1V$ to 30V
Load Regulation	$\Delta V_{OUT}/V_{OUT}$	—	15	30	mV	$I_{OUT} = 100 \mu A$ to 500 mA, Note 2
Dropout Voltage, Note 3	ΔV	—	50	—	mV	$I_{OUT} = 100 \mu A$
		—	260	350		$I_{OUT} = 150 mA$
		—	—	400		$I_{OUT} = 500 mA$
Ground Pin Current	I_{GND}	—	23	40	μA	$V_{EN} \geq 2.0V$, $I_{OUT} = 100 \mu A$
		—	—	45		$V_{EN} \geq 2.0V$, $I_{OUT} = 150 mA$
		—	1.3	5	mA	$V_{EN} \geq 2.0V$, $I_{OUT} = 500 mA$
—	8.5	15	$V_{EN} \geq 2.0V$, $I_{OUT} = 500 mA$			
Ground Pin Shutdown Current	$I_{GND(SHDN)}$	—	0.1	1	μA	$V_{EN} \leq 0.6V$, $V_{IN} = 30V$
Short-Circuit Current	I_{SC}	—	850	1200	mA	$V_{OUT} = 0V$
Output Noise	e_n	—	160	—	μV_{RMS}	10 Hz to 100 kHz, $V_{OUT} = 3.0V$, $C_L = 3.3 \mu F$

MIC5239

ELECTRICAL CHARACTERISTICS (CONTINUED)

Electrical Characteristics: $V_{IN} = V_{OUT} + 1V$; $V_{EN} \geq 2.0V$; $I_{OUT} = 100 \mu A$; $T_J = +25^\circ C$, **bold** values valid for $-40^\circ C \leq T_J \leq +125^\circ C$; unless noted. (Note 1)

Parameter	Symbol	Min.	Typ.	Max.	Units	Conditions
FLAG Output						
Low Threshold	V_{FLG}	—	94	—	%	% of V_{OUT}
High Threshold		—	95	—		
FLAG Output Low Voltage	V_{OL}	—	150	—	mV	$V_{IN} = V_{OUT(NOM)} - 0.12V_{OUT}$, $I_{OL} = 200 \mu A$
FLAG Output Leakage Current	I_{LEAK}	—	0.1	—	μA	$V_{OH} = 30V$
Enable Input						
Input Low Voltage	V_{IL}	—	—	0.6	V	Regulator off
Input High Voltage	V_{IH}	2.0	—	—	V	Regulator on
Enable Input Current	I_{IN}	—	—	1.0	μA	$V_{EN} = 0.6V$, regulator off
		-2.0	0.01	2.0		
		—	0.15	1.0		$V_{EN} = 2.0V$, regulator on
		—	—	2.0		
		—	0.5	2.5		$V_{EN} = 30V$, regulator on
		—	—	5.0		

- Note 1:** Specification for packaged product only.
- 2:** Regulation is measured at constant junction temperature using pulse testing with a low duty-cycle. Changes in output voltage due to heating effects are covered by the specification for thermal regulation.
- 3:** Dropout voltage is defined as the input to output differential at which the output voltage drops 2% below its nominal value measured at 1.0V differential.

TEMPERATURE SPECIFICATIONS (Note 1)

Parameters	Sym.	Min.	Typ.	Max.	Units	Conditions
Temperature Ranges						
Junction Temperature Range	T_J	-40	—	+125	$^\circ C$	—
Storage Temperature Range	T_S	-65	—	+150	$^\circ C$	—
Lead Temperature	—	—	—	+260	$^\circ C$	Soldering, 5 sec.
Package Thermal Resistance						
Thermal Resistance, MSOP 8-Ld	θ_{JA}	—	80	—	$^\circ C/W$	—
Thermal Resistance, SOT-223 3-Ld	θ_{JA}	—	50	—	$^\circ C/W$	—

- Note 1:** The maximum allowable power dissipation is a function of ambient temperature, the maximum allowable junction temperature and the thermal resistance from junction to air (i.e., T_A , T_J , θ_{JA}). Exceeding the maximum allowable power dissipation will cause the device operating junction temperature to exceed the maximum +125 $^\circ C$ rating. Sustained junction temperatures above +125 $^\circ C$ can impact the device reliability.

2.0 TYPICAL PERFORMANCE CURVES

Note: The graphs and tables provided following this note are a statistical summary based on a limited number of samples and are provided for informational purposes only. The performance characteristics listed herein are not tested or guaranteed. In some graphs or tables, the data presented may be outside the specified operating range (e.g., outside specified power supply range) and therefore outside the warranted range.

$V_{OUT} = 3V$

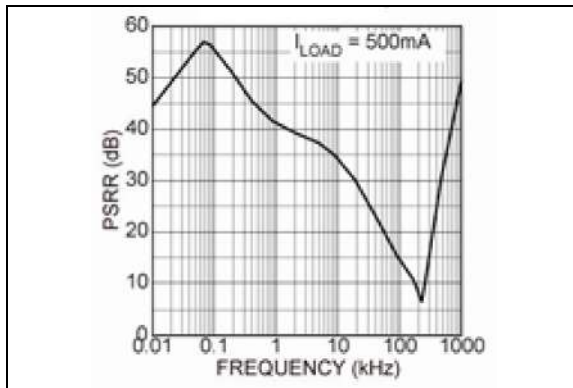

FIGURE 2-1: Power Supply Rejection Ratio.

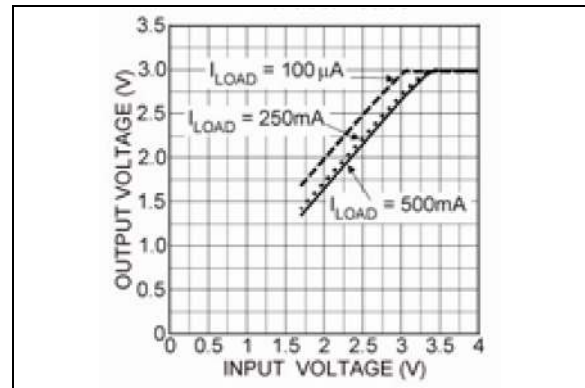

FIGURE 2-4: Dropout Characteristics.

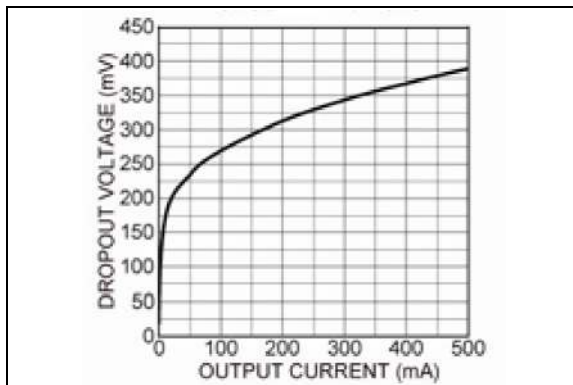

FIGURE 2-2: Dropout Voltage vs. Output Current.

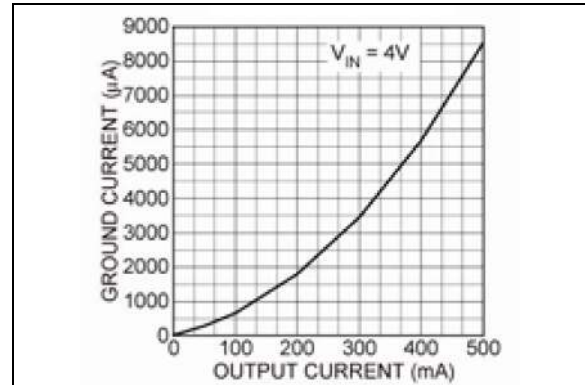

FIGURE 2-5: Ground Pin Current vs. Output Current.

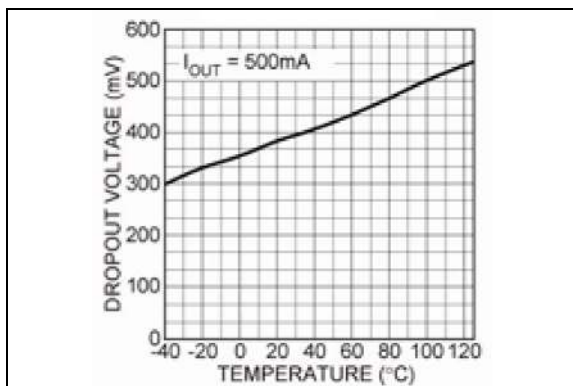

FIGURE 2-3: Dropout Voltage vs. Temperature.

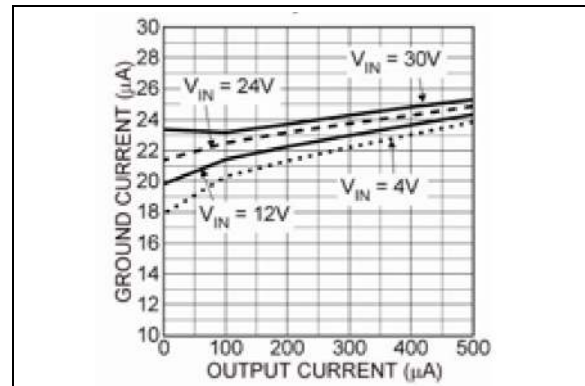

FIGURE 2-6: Ground Pin Current vs. Output Current.

MIC5239

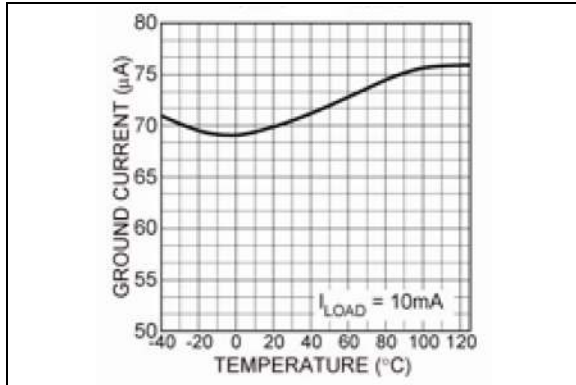

FIGURE 2-7: Ground Pin Current vs. Temperature.

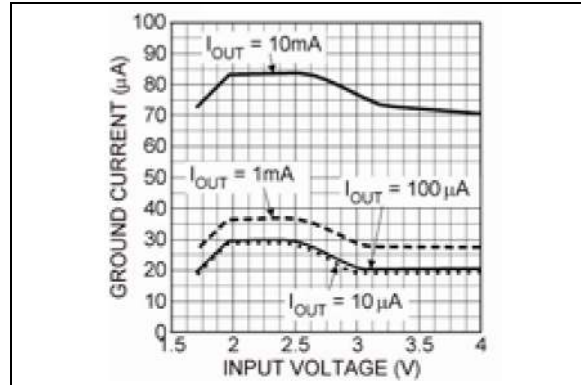

FIGURE 2-10: Ground Pin Current vs. Input Voltage.

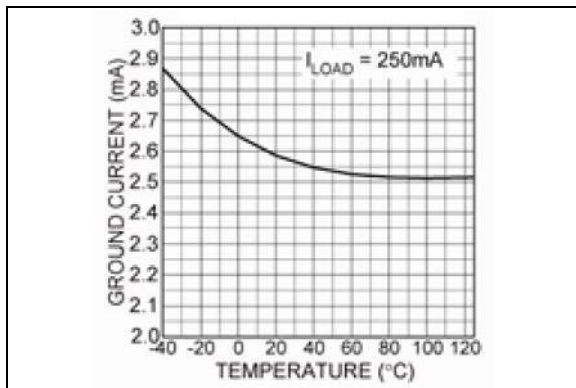

FIGURE 2-8: Ground Pin Current vs. Temperature.

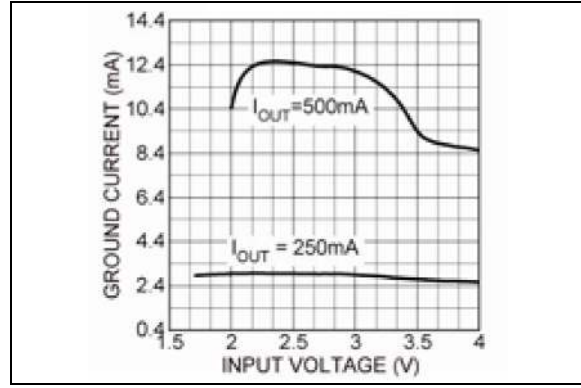

FIGURE 2-11: Ground Pin Current vs. Input Voltage.

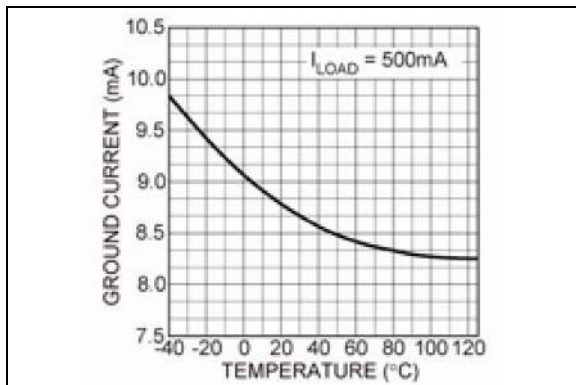

FIGURE 2-9: Ground Pin Current vs. Temperature.

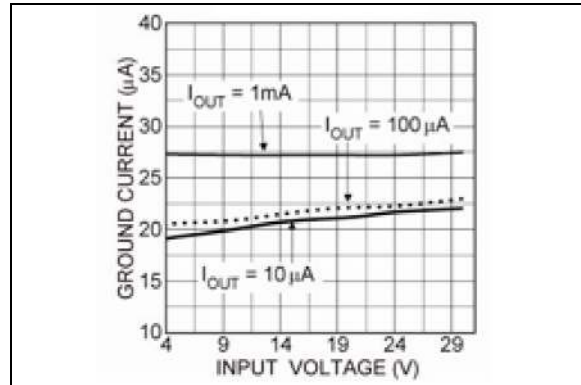

FIGURE 2-12: Ground Pin Current vs. Input Voltage.

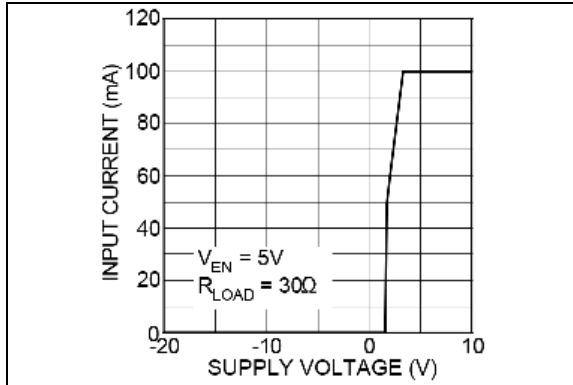

FIGURE 2-13: Input Current.

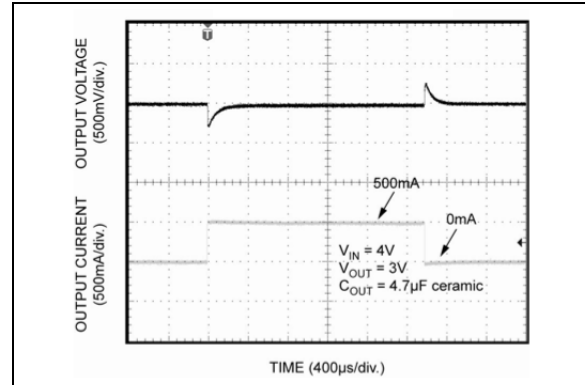

FIGURE 2-16: Load Transient Response.

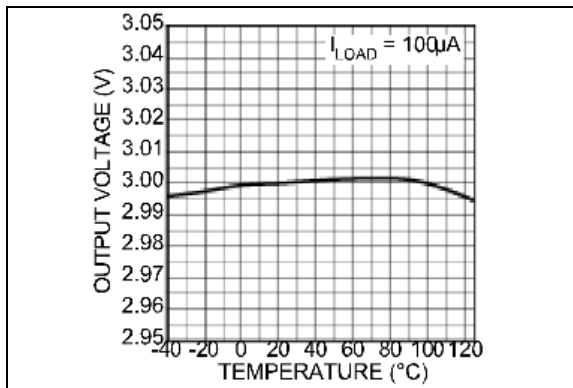

FIGURE 2-14: Output Voltage vs. Temperature.

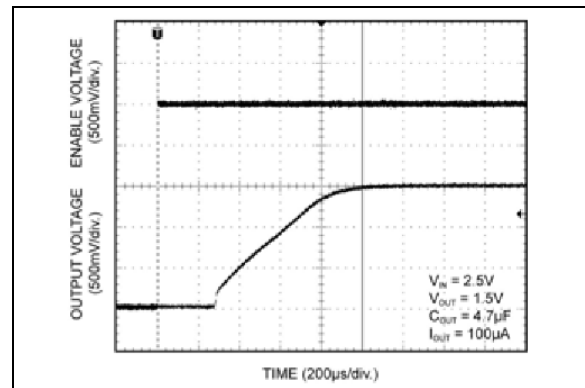

FIGURE 2-17: Enable Turn-On.

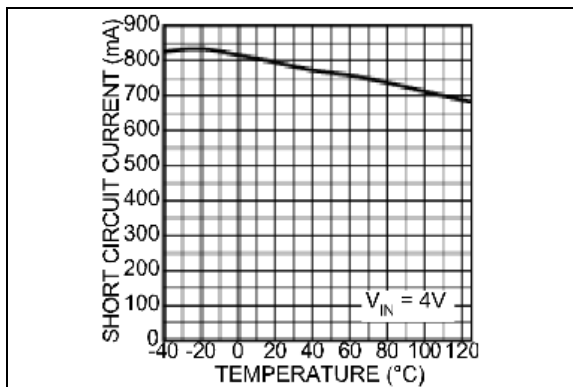

FIGURE 2-15: Short-Circuit Current.

MIC5239

3.0 PIN DESCRIPTIONS

The descriptions of the pins are listed in [Table 3-1](#).

TABLE 3-1: PIN FUNCTION TABLE

Pin Number MSOP/SOIC	Pin Number SOT-223	Pin Name	Description
2 (Fixed)	—	FLG	Error FLAG (Output): Open-collector output is active low when the output is out of regulation due to insufficient input voltage or excessive load. An external pull-up resistor is required.
2 (Adj.)	—	ADJ	Adjustable Feedback Input: Connect to voltage divider network.
3	1	IN	Power Supply Input.
4	3	OUT	Regulated Output.
1	—	EN	Enable (input): Logic low = shutdown; logic high = enabled.
5, 6, 7, 8	2	GND	Ground: Pins 5, 6, 7, and 8 are internally connected in common via the leadframe.

4.0 APPLICATIONS INFORMATION

The MIC5239 provides all of the advantages of the MIC2950: wide input voltage range, and reversed-battery protection, with the added advantages of reduced quiescent current and smaller package. Additionally, when disabled, quiescent current is reduced to 0.1 μA .

4.1 Enable

A low on the enable pin disables the part, forcing the quiescent current to less than 0.1 μA . Thermal shutdown and the error flag are not functional while the device is disabled. The maximum enable bias current is 2 μA for a 2.0V input. An open-collector pull-up resistor tied to the input voltage should be set low enough to maintain 2V on the enable input. Figure 4-1 shows an open-collector output driving the enable pin through a 200 k Ω pull-up resistor tied to the input voltage.

In order to avoid output oscillations, slow transitions from low-to-high should be avoided.

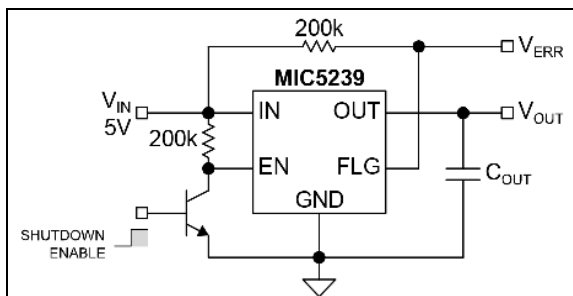

FIGURE 4-1: Remote Enable.

4.2 Input Capacitor

An input capacitor may be required when the device is not near the source power supply or when supplied by a battery. Small, surface mount ceramic capacitors can be used for bypassing. Larger values may be required if the source supply has high ripple.

4.3 Output Capacitor

The MIC5239 has been designed to minimize the effect of the output capacitor ESR on the closed loop stability. As a result, ceramic or film capacitors can be used at the output. Figure 4-2 displays a range of ESR values for a 10 μF capacitor. Virtually any 10 μF capacitor with an ESR less than 3.4 Ω is sufficient for stability over the entire input voltage range. Stability can also be maintained throughout the specified load and line conditions with 4.7 μF film or ceramic capacitors.

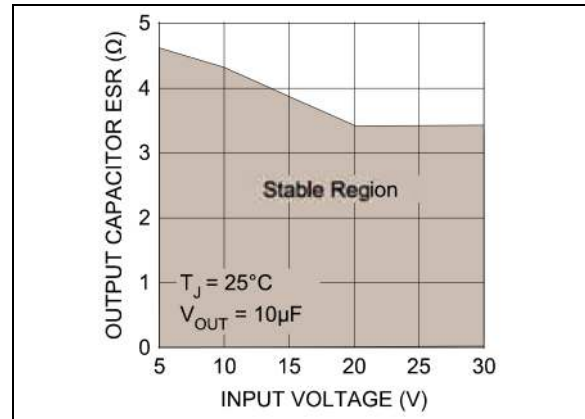

FIGURE 4-2: Output Capacitor ESR.

4.4 Error Detection Comparator Output

The FLAG pin is an open-collector output which goes low when the output voltage drops 5% below its internally programmed level. It senses conditions such as excessive load (current limit), low input voltage, and overtemperature conditions. Once the part is disabled via the enable input, the error flag output is not valid. Overvoltage conditions are not reflected in the error flag output. The error flag output is also not valid for input voltages less than 2.3V.

The error output has a low voltage of 400 mV at a current of 200 μA . In order to minimize the drain on the source used for the pull-up, a value of 200 k Ω to 1 M Ω is suggested for the error flag pull-up. This will guarantee a maximum low voltage of 0.4V for a 30V pull-up potential. An unused error flag can be left unconnected.

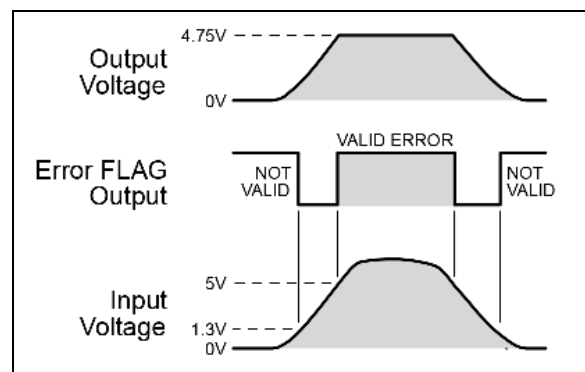

FIGURE 4-3: Error FLAG Output Timing.

4.5 Thermal Shutdown

The MIC5239 has integrated thermal protection. This feature is only for protection purposes. The device should never be intentionally operated near this temperature as this may have detrimental effects on the life of the device. The thermal shutdown may become inactive while the enable input is transitioning

MIC5239

from a high to a low. When disabling the device via the enable pin, transition from a high to low quickly. This will insure that the output remains disabled in the event of a thermal shutdown.

4.6 Current Limit

Figure 4-4 displays a method for reducing the steady state short-circuit current. The duration that the supply delivers current is set by the time required for the error flag output to discharge the 4.7 μF capacitor tied to the enable pin. The off time is set by the 200 k Ω resistor as it recharges the 4.7 μF capacitor, enabling the regulator. This circuit reduces the short-circuit current from 800 mA to 40 mA while allowing for regulator restart once the short is removed.

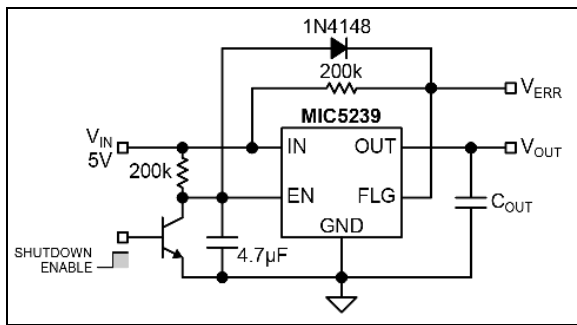

FIGURE 4-4: Remote Enable with Short-Circuit Current Foldback.

4.7 Thermal Characteristics

The MIC5239 is a high input voltage device, intended to provide 500 mA of continuous output current in two very small profile packages. The power MSOP-8 allows the device to dissipate about 50% more power than their standard equivalents.

4.7.1 POWER MSOP-8 THERMAL CHARACTERISTICS

One of the secrets of the MIC5239's performance is its power MSOP-8 package featuring half the thermal resistance of a standard MSOP-8 package. Lower thermal resistance means more output current or higher input voltage for a given package size.

Lower thermal resistance is achieved by joining the four ground leads with the die attach paddle to create a single piece electrical and thermal conductor. This concept has been used by MOSFET manufacturers for years, proving very reliable and cost effective for the user.

Thermal resistance consists of two main elements, θ_{JC} (junction-to-case thermal resistance) and θ_{CA} (case-to-ambient thermal resistance). See Figure 4-5. θ_{JC} is the resistance from the die to the leads of the package. θ_{CA} is the resistance from the leads to the

ambient air and it includes θ_{CS} (case-to-sink thermal resistance) and θ_{SA} (sink-to-ambient thermal resistance).

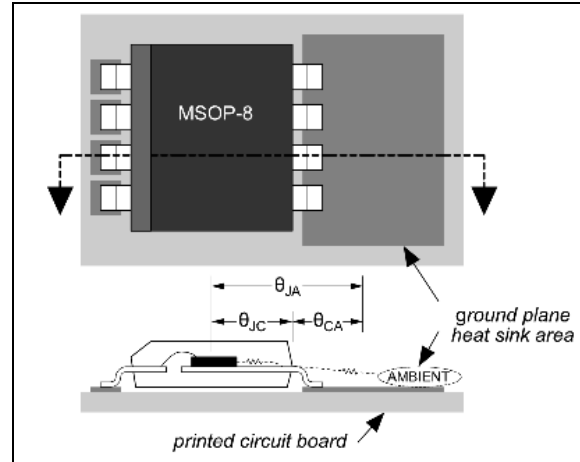

FIGURE 4-5: Thermal Resistance.

Using the power MSOP-8 reduces the θ_{JC} dramatically and allows the user to reduce θ_{CA} . The total thermal resistance, θ_{JA} (junction-to-ambient thermal resistance) is the limiting factor in calculating the maximum power dissipation capability of the device. Typically, the power MSOP-8 has a θ_{JC} of 80°C/W. This is significantly lower than the standard MSOP-8, which is typically 200°C/W. θ_{CA} is reduced because pins 5 through 8 can now be soldered directly to a ground plane that significantly reduces the case-to-sink thermal resistance and sink to ambient thermal resistance.

Low-dropout linear regulators from Microchip are rated to a maximum junction temperature of 125°C. It is important not to exceed this maximum junction temperature during operation of the device. To prevent this maximum junction temperature from being exceeded, the appropriate ground plane heatsink must be used.

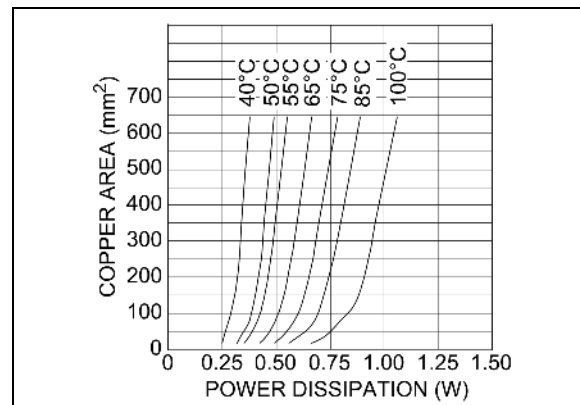

FIGURE 4-6: Copper Area vs. Power-MSOP Power Dissipation ($\Delta\theta_{\text{JA}}$).

Figure 4-6 shows copper area versus power dissipation with each trace corresponding to a different temperature rise above ambient.

From these curves, the minimum area of copper necessary for the part to operate safely can be determined. The maximum allowable temperature rise must be calculated to determine operation along which curve.

EQUATION 4-1:

$$\Delta T = T_{J(MAX)} - T_{A(MAX)}$$

Where:

$T_{J(MAX)} = 125^{\circ}\text{C}$

$T_{A(MAX)}$ = Maximum ambient operating temperature.

For example, the maximum ambient temperature is 50°C , the ΔT is determined as follows:

EQUATION 4-2:

$$\Delta T = 125^{\circ}\text{C} - 50^{\circ}\text{C} = 75^{\circ}\text{C}$$

Using Figure 4-6, the minimum amount of required copper can be determined based on the required power dissipation. Power dissipation in a linear regulator is calculated as follows:

EQUATION 4-3:

$$P_D = (V_{IN} - V_{OUT}) \times I_{OUT} + V_{IN} \times I_{GND}$$

If we use a 3V output device and a 28V input at moderate output current of 25 mA, then the power dissipation is as follows:

EQUATION 4-4:

$$P_D = (28\text{V} - 3\text{V}) \times 25\text{mA} + 28\text{V} \times 250\mu\text{A}$$

$$P_D = 625\text{mW} + 7\text{mW} = 632\text{mW}$$

From Figure 4-6, the minimum amount of copper required to operate this application at a ΔT of 75°C is 110mm^2 .

4.7.2 QUICK METHOD

Determine the power dissipation requirements for the design along with the maximum ambient temperature at which the device will be operated. Refer to Figure 4-7, which shows safe operating curves for three different ambient temperatures: 25°C , 50°C , and 85°C . From these curves, the minimum amount of copper can be determined by knowing the maximum power dissipation required. If the maximum ambient temperature is 50°C and the power dissipation is 632 mW, the curve in Figure 4-7 shows that the required area of copper is 110mm^2 .

The θ_{JA} of this package is ideally 80°C/W , but it will vary depending upon the availability of copper ground plane to which it is attached.

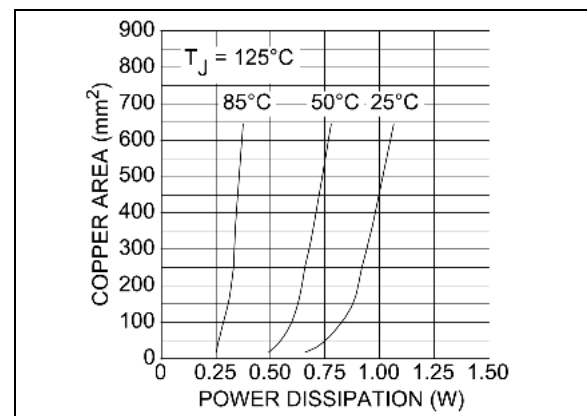

FIGURE 4-7: Copper Area vs. Power-MSOP Power Dissipation (T_A).

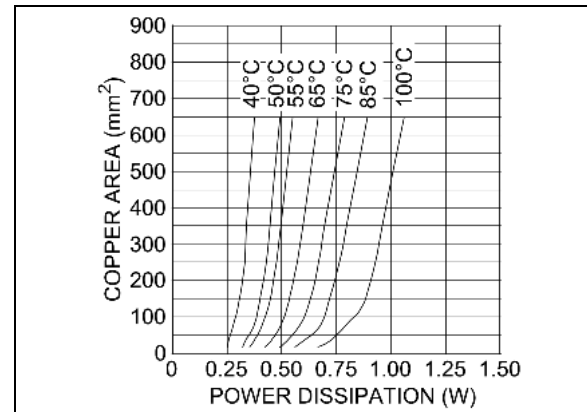

FIGURE 4-8: Copper Area vs. Power-SOIC Power Dissipation ($\Delta\theta_{JA}$).

MIC5239

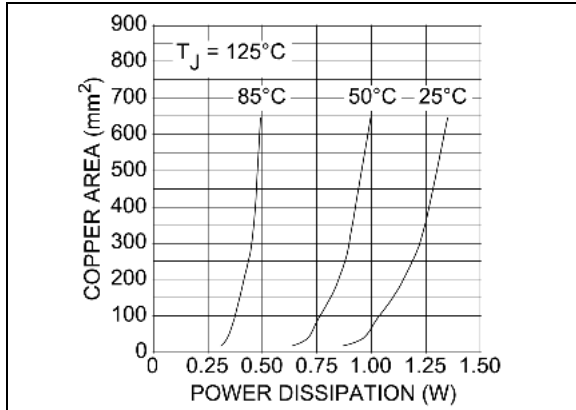

FIGURE 4-9: Copper Area vs. Power-SOIC Power Dissipation (T_A).

The same method of determining the heatsink area used for the power MSOP-8 can be applied directly to the power SOIC-8. The same two curves showing power dissipation versus copper area are reproduced for the power SOIC-8 and they can be applied identically.

4.8 Power SOIC-8 Thermal Characteristics

The power SOIC-8 package follows the same idea as the power MSOP-8 package, using four ground leads with the die attach paddle to create a single-piece electrical and thermal conductor, reducing thermal resistance and increasing power dissipation capability.

4.8.1 QUICK METHOD

Determine the power dissipation requirements for the design along with the maximum ambient temperature at which the device will be operated. Refer to [Figure 4-9](#), which shows safe operating curves for three different ambient temperatures, 25°C, 50°C, and 85°C. From these curves, the minimum amount of copper can be determined by knowing the maximum power dissipation required. If the maximum ambient temperature is 50°C, and the power dissipation is 632 mW, the curve in [Figure 4-9](#) shows that the required area of copper is less than 100 mm², when using the power SOIC-8.

4.9 Adjustable Regulator Application

The MIC5239YM can be adjusted from 1.24V to 20V by using two external resistors ([Figure 4-10](#)). The resistors set the output voltage based on the following equation:

EQUATION 4-5:

$$V_{OUT} = V_{REF} \times \left(1 + \frac{R1}{R2}\right)$$

Where:

$$V_{REF} = 1.23V$$

Feedback resistor R2 should be no larger than 300 kΩ.

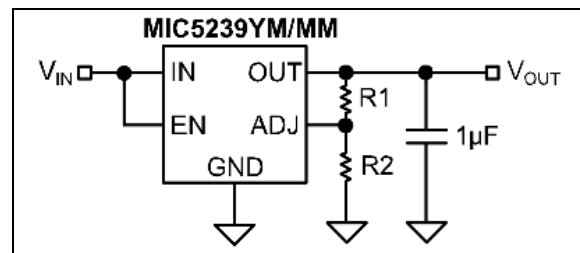
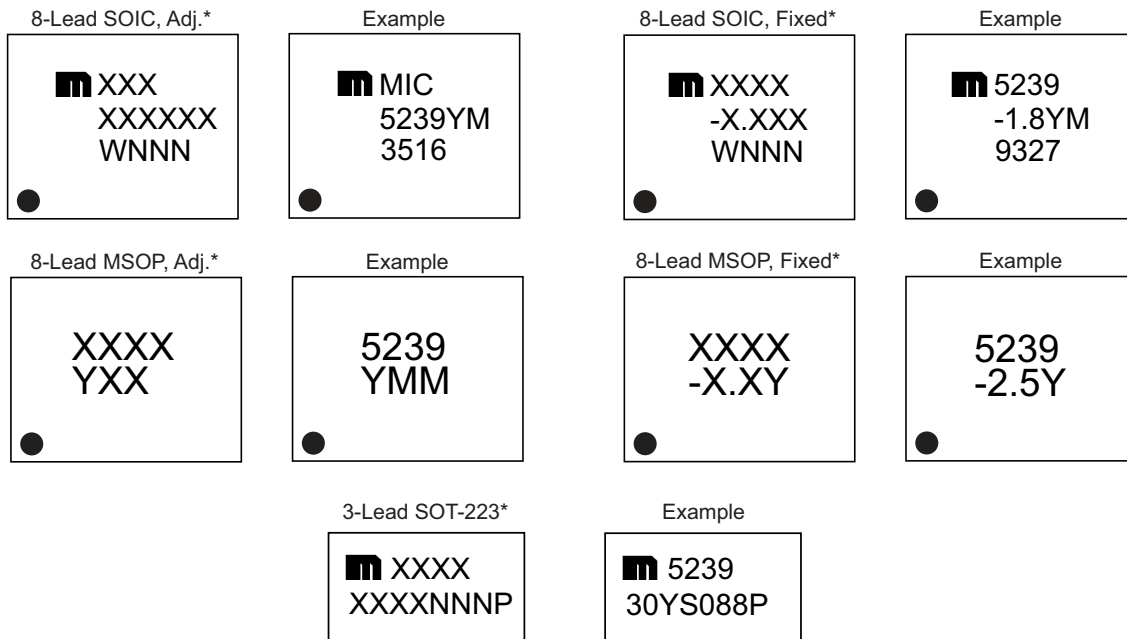

FIGURE 4-10: Adjustable Voltage Application.

5.0 PACKAGING INFORMATION

5.1 Package Marking Information



<p>Legend:</p> <p>XX...X Product code or customer-specific information</p> <p>Y Year code (last digit of calendar year)</p> <p>YY Year code (last 2 digits of calendar year)</p> <p>WW Week code (week of January 1 is week '01')</p> <p>NNN Alphanumeric traceability code</p> <p>(e3) Pb-free JEDEC® designator for Matte Tin (Sn)</p> <p>* This package is Pb-free. The Pb-free JEDEC designator ((e3)) can be found on the outer packaging for this package.</p> <p>•, ▲, ▼ Pin one index is identified by a dot, delta up, or delta down (triangle mark).</p>

Note: In the event the full Microchip part number cannot be marked on one line, it will be carried over to the next line, thus limiting the number of available characters for customer-specific information. Package may or may not include the corporate logo.

Underbar (_) and/or Overbar (¯) symbol may not be to scale.

MIC5239

8-Lead SOIC Package Outline and Recommended Land Pattern

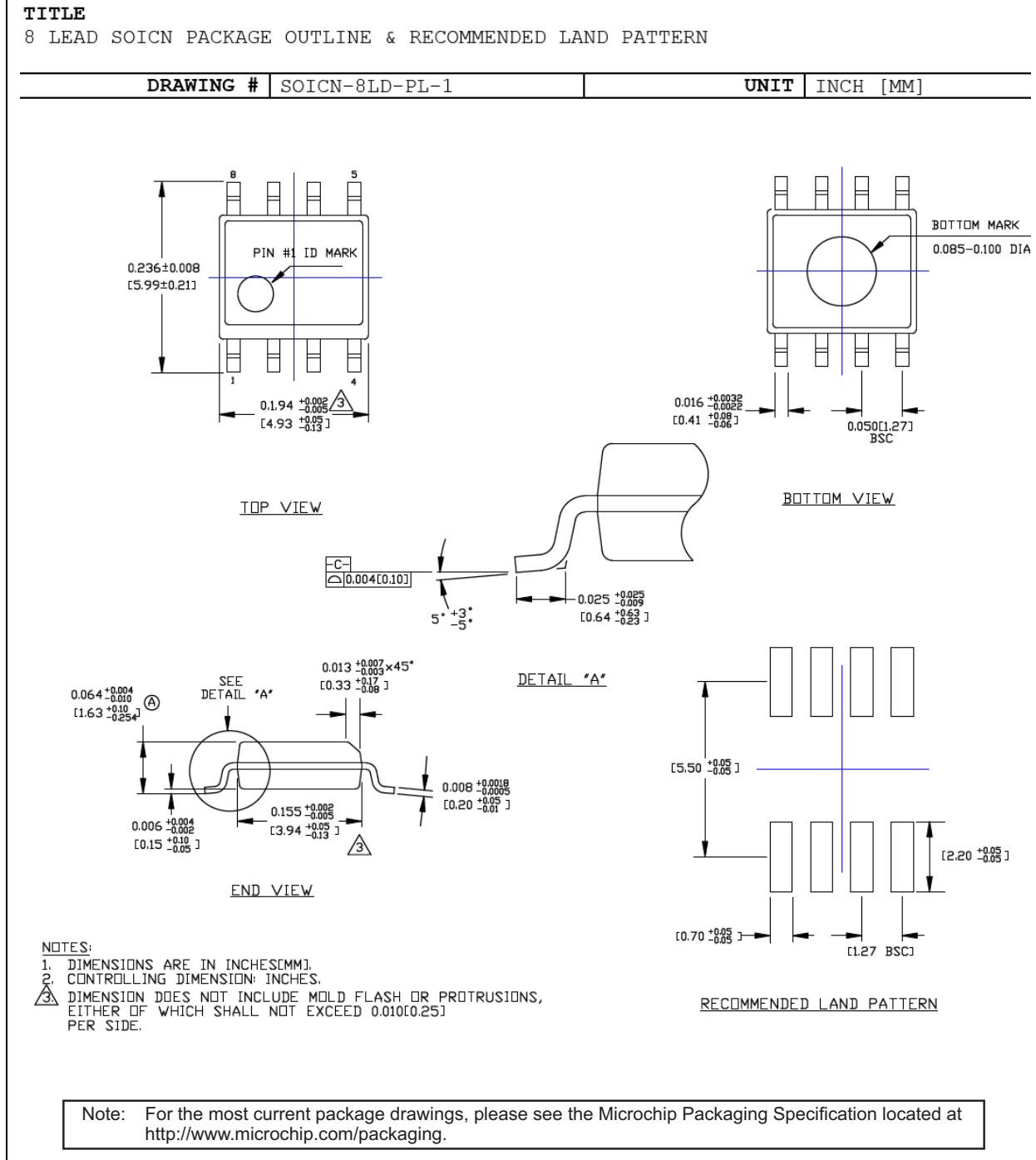

8-Lead MSOP Package Outline and Recommended Land Pattern

TITLE

8 LEAD MSOP PACKAGE OUTLINE & RECOMMENDED LAND PATTERN

DRAWING #	MSOP-8LD-PL-1	UNIT	INCH [MM]
-----------	---------------	------	-----------

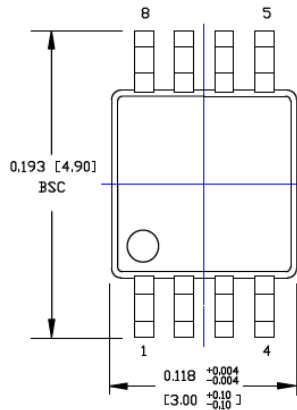

TOP VIEW

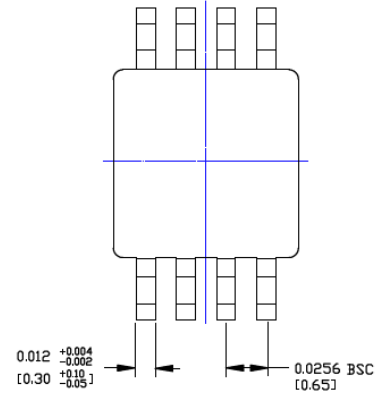

BOTTOM VIEW

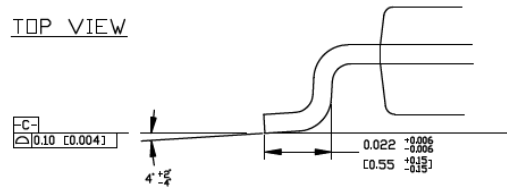

DETAIL A

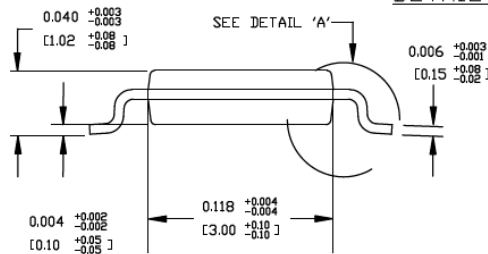

SIDE VIEW

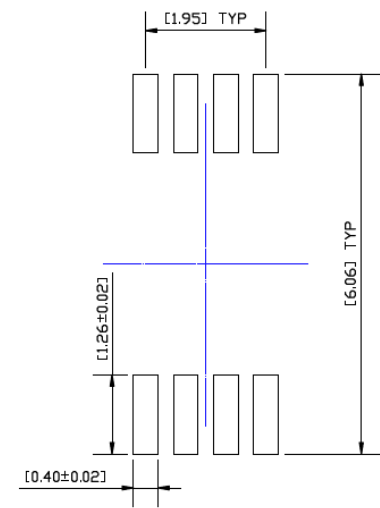

RECOMMENDED LAND PATTERN

NOTES:

1. DIMENSIONS ARE IN INCHES [MM].
2. CONTROLLING DIMENSION: MM.
3. DIMENSION DOES NOT INCLUDE MOLD FLASH OR PROTRUSIONS, EITHER OF WHICH SHALL NOT EXCEED 0.008 [0.20] PER SIDE.

Note: For the most current package drawings, please see the Microchip Packaging Specification located at <http://www.microchip.com/packaging>.

MIC5239

3-Lead SOT-223 Package Outline and Recommended Land Pattern

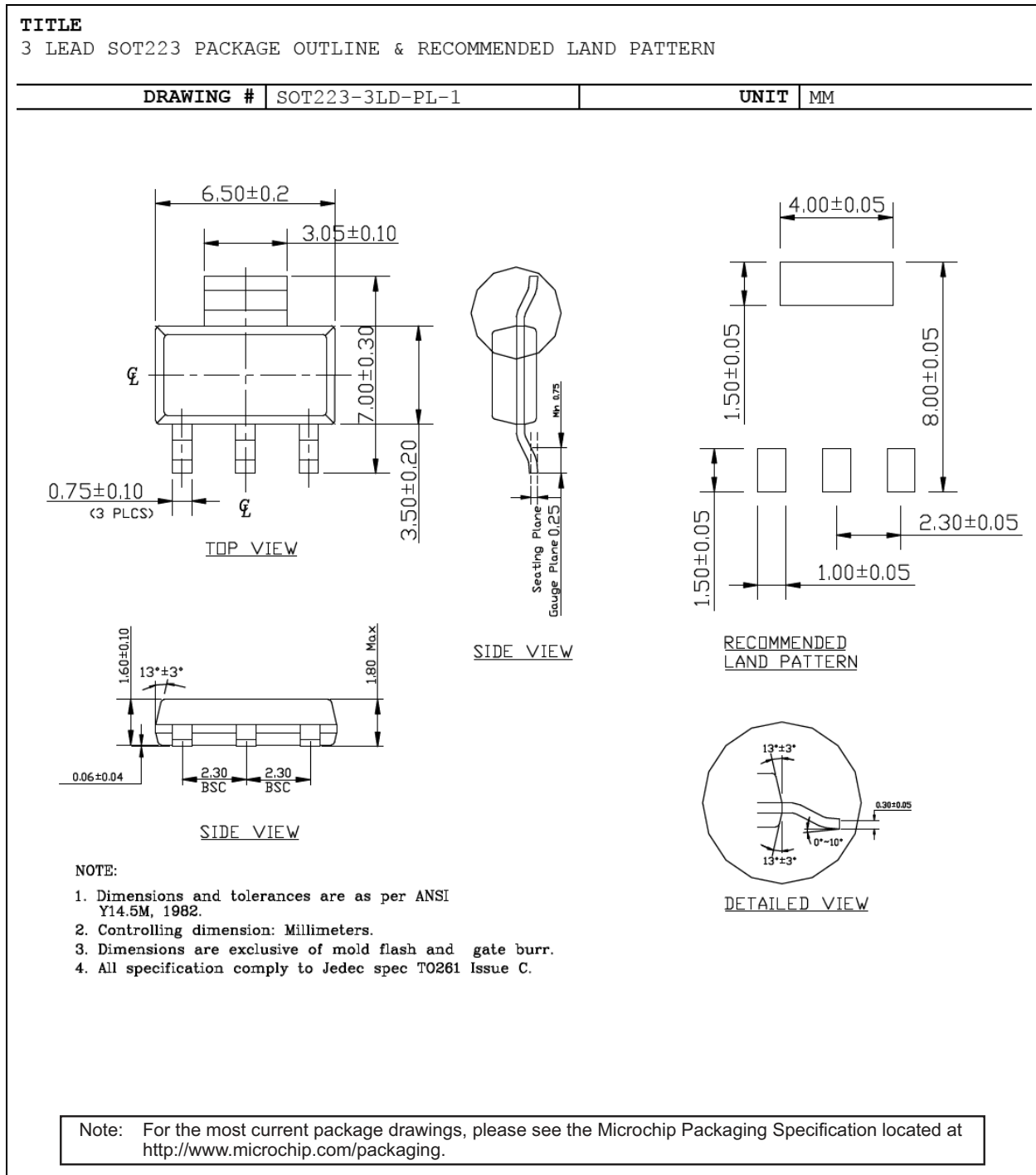

APPENDIX A: REVISION HISTORY

Revision A (June 2021)

- Converted Micrel document MIC5239 to Microchip data sheet DS20006544A.
- Minor text changes throughout.

MIC5239

NOTES:

PRODUCT IDENTIFICATION SYSTEM

To order or obtain information, e.g., on pricing or delivery, contact your local Microchip representative or sales office.

<u>PART No.</u>	<u>-X.X</u>	<u>X</u>	<u>X</u>	<u>-XX</u>	Examples:
Device	Output Voltage	Junction Temp. Range	Package	Media Type	
Device:	MIC5239:	Low Quiescent Current 500 mA μ Cap LDO Regulator			a) MIC5239-5.0YMM-TR: MIC5239, 5.0V Output Voltage, -40°C to +125°C Temperature Range, 8-Lead MSOP, 2,500/Reel
Output Voltage:	1.5 = 1.5V 1.8 = 1.8V 2.5 = 2.5V 3.0 = 3.0V 3.3 = 3.3V 5.0 = 5.0V <blank>= Adjustable (Not applicable to SOT-223 option)				b) MIC5239YM: MIC5239, Adj. Output Voltage, -40°C to +125°C Temperature Range, 8-Lead SOIC, 95/Tube
Junction Temperature Range:	Y = -40°C to +125°C				c) MIC5239-1.8YS: MIC5239, 1.8V Output Voltage, -40°C to +125°C Temperature Range, 3-Lead SOT-223, 78/Tube
Package:	M = 8-Lead SOIC MM = 8-Lead MSOP S = 3-Lead SOT-223				d) MIC5239YMM-TR: MIC5239, Adj. Output Voltage, -40°C to +125°C Temperature Range, 8-Lead MSOP, 100/Tube
Media Type:	<blank> = 78/Tube (SOT-223 Only) <blank> = 95/Tube (SOIC Only) <blank> = 100/Tube (MSOP Only) TR = 2,500/Reel (All package options)				e) MIC5239-3.0YM-TR: MIC5239, 3.0V Output Voltage, -40°C to +125°C Temperature Range, 8-Lead SOIC, 2,500/Reel
					f) MIC5239-2.5YS-TR: MIC5239, 2.5V Output Voltage, -40°C to +125°C Temperature Range, 3-Lead SOT-223, 2,500/Reel
					Note 1: Tape and Reel identifier only appears in the catalog part number description. This identifier is used for ordering purposes and is not printed on the device package. Check with your Microchip Sales Office for package availability with the Tape and Reel option.

MIC5239

NOTES:

Note the following details of the code protection feature on Microchip devices:

- Microchip products meet the specifications contained in their particular Microchip Data Sheet.
- Microchip believes that its family of products is secure when used in the intended manner and under normal conditions.
- There are dishonest and possibly illegal methods being used in attempts to breach the code protection features of the Microchip devices. We believe that these methods require using the Microchip products in a manner outside the operating specifications contained in Microchip's Data Sheets. Attempts to breach these code protection features, most likely, cannot be accomplished without violating Microchip's intellectual property rights.
- Microchip is willing to work with any customer who is concerned about the integrity of its code.
- Neither Microchip nor any other semiconductor manufacturer can guarantee the security of its code. Code protection does not mean that we are guaranteeing the product is "unbreakable." Code protection is constantly evolving. We at Microchip are committed to continuously improving the code protection features of our products. Attempts to break Microchip's code protection feature may be a violation of the Digital Millennium Copyright Act. If such acts allow unauthorized access to your software or other copyrighted work, you may have a right to sue for relief under that Act.

Information contained in this publication is provided for the sole purpose of designing with and using Microchip products. Information regarding device applications and the like is provided only for your convenience and may be superseded by updates. It is your responsibility to ensure that your application meets with your specifications.

THIS INFORMATION IS PROVIDED BY MICROCHIP "AS IS". MICROCHIP MAKES NO REPRESENTATIONS OR WARRANTIES OF ANY KIND WHETHER EXPRESS OR IMPLIED, WRITTEN OR ORAL, STATUTORY OR OTHERWISE, RELATED TO THE INFORMATION INCLUDING BUT NOT LIMITED TO ANY IMPLIED WARRANTIES OF NON-INFRINGEMENT, MERCHANTABILITY, AND FITNESS FOR A PARTICULAR PURPOSE OR WARRANTIES RELATED TO ITS CONDITION, QUALITY, OR PERFORMANCE.

IN NO EVENT WILL MICROCHIP BE LIABLE FOR ANY INDIRECT, SPECIAL, PUNITIVE, INCIDENTAL OR CONSEQUENTIAL LOSS, DAMAGE, COST OR EXPENSE OF ANY KIND WHATSOEVER RELATED TO THE INFORMATION OR ITS USE, HOWEVER CAUSED, EVEN IF MICROCHIP HAS BEEN ADVISED OF THE POSSIBILITY OR THE DAMAGES ARE FORESEEABLE. TO THE FULLEST EXTENT ALLOWED BY LAW, MICROCHIP'S TOTAL LIABILITY ON ALL CLAIMS IN ANY WAY RELATED TO THE INFORMATION OR ITS USE WILL NOT EXCEED THE AMOUNT OF FEES, IF ANY, THAT YOU HAVE PAID DIRECTLY TO MICROCHIP FOR THE INFORMATION. Use of Microchip devices in life support and/or safety applications is entirely at the buyer's risk, and the buyer agrees to defend, indemnify and hold harmless Microchip from any and all damages, claims, suits, or expenses resulting from such use. No licenses are conveyed, implicitly or otherwise, under any Microchip intellectual property rights unless otherwise stated.

Trademarks

The Microchip name and logo, the Microchip logo, Adaptec, AnyRate, AVR, AVR logo, AVR Freaks, BesTime, BitCloud, chipKIT, chipKIT logo, CryptoMemory, CryptoRF, dsPIC, FlashFlex, flexPWR, HELDO, IGL00, JukeBlox, KeeLoq, Kleer, LANCheck, LinkMD, maXStylus, maXTouch, MediaLB, megaAVR, Microsemi, Microsemi logo, MOST, MOST logo, MPLAB, OptoLyzer, PackeTime, PIC, picoPower, PICSTART, PIC32 logo, PolarFire, Prochip Designer, QTouch, SAM-BA, SenGenuity, SpyNIC, SST, SST Logo, SuperFlash, Symmetricom, SyncServer, Tachyon, TimeSource, tinyAVR, UNI/O, Vectron, and XMEGA are registered trademarks of Microchip Technology Incorporated in the U.S.A. and other countries.

AgileSwitch, APT, ClockWorks, The Embedded Control Solutions Company, EtherSynch, FlashTec, Hyper Speed Control, HyperLight Load, IntelliMOS, Libero, motorBench, mTouch, Powermite 3, Precision Edge, ProASIC, ProASIC Plus, ProASIC Plus logo, Quiet-Wire, SmartFusion, SyncWorld, Temux, TimeCesium, TimeHub, TimePictra, TimeProvider, WinPath, and ZL are registered trademarks of Microchip Technology Incorporated in the U.S.A.

Adjacent Key Suppression, AKS, Analog-for-the-Digital Age, Any Capacitor, AnyIn, AnyOut, Augmented Switching, BlueSky, BodyCom, CodeGuard, CryptoAuthentication, CryptoAutomotive, CryptoCompanion, CryptoController, dsPICDEM, dsPICDEM.net, Dynamic Average Matching, DAM, ECAN, Espresso T1S, EtherGREEN, IdealBridge, In-Circuit Serial Programming, ICSP, INICnet, Intelligent Paralleling, Inter-Chip Connectivity, JitterBlocker, maxCrypto, maxView, memBrain, Mindi, MiWi, MPASM, MPF, MPLAB Certified logo, MPLIB, MPLINK, MultiTRAK, NetDetach, Omniscient Code Generation, PICDEM, PICDEM.net, PICkit, PICtail, PowerSmart, PureSilicon, QMatrix, REAL ICE, Ripple Blocker, RTAX, RTG4, SAM-ICE, Serial Quad I/O, simpleMAP, SimpliPHY, SmartBuffer, SMART-I.S., storClad, SQI, SuperSwitcher, SuperSwitcher II, Switchtec, SynchroPHY, Total Endurance, TSHARC, USBCheck, VariSense, VectorBlox, VeriPHY, ViewSpan, WiperLock, XpressConnect, and ZENA are trademarks of Microchip Technology Incorporated in the U.S.A. and other countries.

SQTP is a service mark of Microchip Technology Incorporated in the U.S.A.

The Adaptec logo, Frequency on Demand, Silicon Storage Technology, and Symmcom are registered trademarks of Microchip Technology Inc. in other countries.

GestIC is a registered trademark of Microchip Technology Germany II GmbH & Co. KG, a subsidiary of Microchip Technology Inc., in other countries.

All other trademarks mentioned herein are property of their respective companies.

© 2021, Microchip Technology Incorporated, All Rights Reserved.

ISBN: 978-1-5224-8316-8

For information regarding Microchip's Quality Management Systems, please visit www.microchip.com/quality.



MICROCHIP

Worldwide Sales and Service

AMERICAS

Corporate Office
2355 West Chandler Blvd.
Chandler, AZ 85224-6199
Tel: 480-792-7200
Fax: 480-792-7277
Technical Support:
<http://www.microchip.com/support>
Web Address:
www.microchip.com

Atlanta

Duluth, GA
Tel: 678-957-9614
Fax: 678-957-1455

Austin, TX

Tel: 512-257-3370

Boston

Westborough, MA
Tel: 774-760-0087
Fax: 774-760-0088

Chicago

Itasca, IL
Tel: 630-285-0071
Fax: 630-285-0075

Dallas

Addison, TX
Tel: 972-818-7423
Fax: 972-818-2924

Detroit

Novi, MI
Tel: 248-848-4000

Houston, TX

Tel: 281-894-5983

Indianapolis

Noblesville, IN
Tel: 317-773-8323
Fax: 317-773-5453
Tel: 317-536-2380

Los Angeles

Mission Viejo, CA
Tel: 949-462-9523
Fax: 949-462-9608
Tel: 951-273-7800

Raleigh, NC

Tel: 919-844-7510

New York, NY

Tel: 631-435-6000

San Jose, CA

Tel: 408-735-9110
Tel: 408-436-4270

Canada - Toronto

Tel: 905-695-1980
Fax: 905-695-2078

ASIA/PACIFIC

Australia - Sydney
Tel: 61-2-9868-6733

China - Beijing
Tel: 86-10-8569-7000

China - Chengdu
Tel: 86-28-8665-5511

China - Chongqing
Tel: 86-23-8980-9588

China - Dongguan
Tel: 86-769-8702-9880

China - Guangzhou
Tel: 86-20-8755-8029

China - Hangzhou
Tel: 86-571-8792-8115

China - Hong Kong SAR
Tel: 852-2943-5100

China - Nanjing
Tel: 86-25-8473-2460

China - Qingdao
Tel: 86-532-8502-7355

China - Shanghai
Tel: 86-21-3326-8000

China - Shenyang
Tel: 86-24-2334-2829

China - Shenzhen
Tel: 86-755-8864-2200

China - Suzhou
Tel: 86-186-6233-1526

China - Wuhan
Tel: 86-27-5980-5300

China - Xian
Tel: 86-29-8833-7252

China - Xiamen
Tel: 86-592-2388138

China - Zhuhai
Tel: 86-756-3210040

ASIA/PACIFIC

India - Bangalore
Tel: 91-80-3090-4444

India - New Delhi
Tel: 91-11-4160-8631

India - Pune
Tel: 91-20-4121-0141

Japan - Osaka
Tel: 81-6-6152-7160

Japan - Tokyo
Tel: 81-3-6880-3770

Korea - Daegu
Tel: 82-53-744-4301

Korea - Seoul
Tel: 82-2-554-7200

Malaysia - Kuala Lumpur
Tel: 60-3-7651-7906

Malaysia - Penang
Tel: 60-4-227-8870

Philippines - Manila
Tel: 63-2-634-9065

Singapore
Tel: 65-6334-8870

Taiwan - Hsin Chu
Tel: 886-3-577-8366

Taiwan - Kaohsiung
Tel: 886-7-213-7830

Taiwan - Taipei
Tel: 886-2-2508-8600

Thailand - Bangkok
Tel: 66-2-694-1351

Vietnam - Ho Chi Minh
Tel: 84-28-5448-2100

EUROPE

Austria - Wels
Tel: 43-7242-2244-39
Fax: 43-7242-2244-393

Denmark - Copenhagen
Tel: 45-4485-5910
Fax: 45-4485-2829

Finland - Espoo
Tel: 358-9-4520-820

France - Paris
Tel: 33-1-69-53-63-20
Fax: 33-1-69-30-90-79

Germany - Garching
Tel: 49-8931-9700

Germany - Haan
Tel: 49-2129-3766400

Germany - Heilbronn
Tel: 49-7131-72400

Germany - Karlsruhe
Tel: 49-721-625370

Germany - Munich
Tel: 49-89-627-144-0
Fax: 49-89-627-144-44

Germany - Rosenheim
Tel: 49-8031-354-560

Israel - Ra'anana
Tel: 972-9-744-7705

Italy - Milan
Tel: 39-0331-742611
Fax: 39-0331-466781

Italy - Padova
Tel: 39-049-7625286

Netherlands - Drunen
Tel: 31-416-690399
Fax: 31-416-690340

Norway - Trondheim
Tel: 47-7288-4388

Poland - Warsaw
Tel: 48-22-3325737

Romania - Bucharest
Tel: 40-21-407-87-50

Spain - Madrid
Tel: 34-91-708-08-90
Fax: 34-91-708-08-91

Sweden - Gothenberg
Tel: 46-31-704-60-40

Sweden - Stockholm
Tel: 46-8-5090-4654

UK - Wokingham
Tel: 44-118-921-5800
Fax: 44-118-921-5820