

## Specification of Temperature Probe

**PART NUMBER: TT4-PT100B-T300-1500**

No. of pages: 1

Date: **24.09.2015**

Revision: **00**

FEATURES:

Sensing Element	PT100
Class according to EN 60751	B
Temperature Coefficient	TCR = 3850 ppm/k
Operating temperature range	-40°C ÷ 300°C
<b>Test Voltage</b>	<b>1000V DC</b>
<b>International Protection Rating</b>	<b>IP 65</b>
<b>RoHS Compatible</b>	<b>YES</b>

DRAWING:

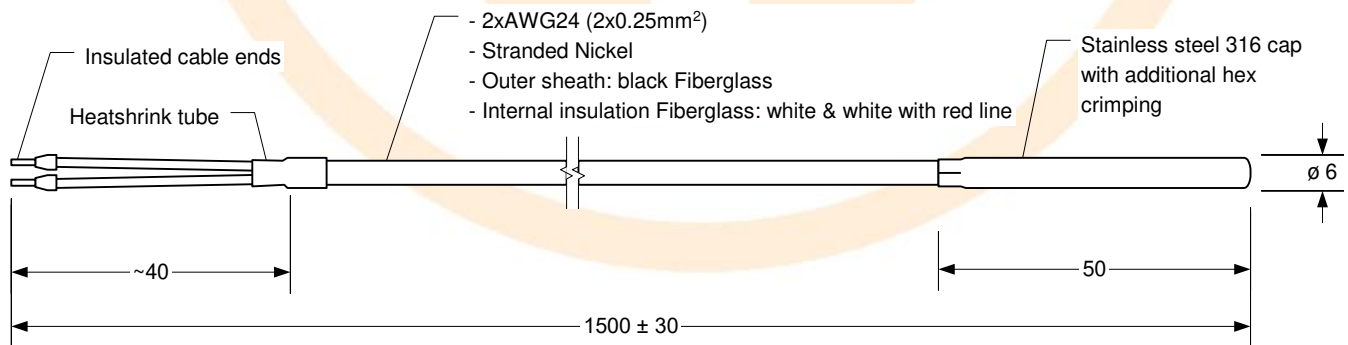

UNITS: [mm]