

Replaced by MW4IC001NR4. There are no form, fit or function changes with this part replacement. N suffix added to part number to indicate transition to lead-free terminations.

RF LDMOS Wideband Integrated Power Amplifier

The MW4IC001M wideband integrated circuit is designed for use as a distortion signature device in analog predistortion systems. It uses Freescale's newest High Voltage (26 to 28 Volts) LDMOS IC technology. Its wideband On Chip design makes it usable from 800 MHz to 2170 MHz. The linearity performances cover all modulations for cellular applications: GSM EDGE, TDMA, CDMA and W-CDMA.

- Typical CW Performance at 2170 MHz, 28 Volts, $I_{DQ} = 12$ mA
Output Power — 900 mW PEP
Power Gain — 13 dB
Efficiency — 38%
- High Gain, High Efficiency and High Linearity
- Designed for Maximum Gain and Insertion Phase Flatness
- Excellent Thermal Stability
- Characterized with Series Equivalent Large-Signal Impedance Parameters
- In Tape and Reel. R4 Suffix = 100 Units per 12 mm, 7 inch Reel.

MW4IC001MR4

**800-2170 MHz, 900 mW, 28 V
W-CDMA
RF LDMOS WIDEBAND
INTEGRATED POWER AMPLIFIER**

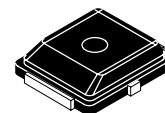

**CASE 466-03, STYLE 1
PLD-1.5
PLASTIC**

ARCHIVE INFORMATION

ARCHIVE INFORMATION

Table 1. Maximum Ratings

Rating	Symbol	Value	Unit
Drain-Source Voltage	V_{DSS}	- 0.5, +65	Vdc
Gate-Source Voltage	V_{GS}	- 0.5, +15	Vdc
Total Device Dissipation @ $T_C = 25^\circ\text{C}$ Derate above 25°C	P_D	4.58 0.037	W W/ $^\circ\text{C}$
Storage Temperature Range	T_{stg}	- 65 to +150	$^\circ\text{C}$
Operating Junction Temperature	T_J	150	$^\circ\text{C}$

Table 2. Thermal Characteristics

Characteristic	Symbol	Value	Unit
Thermal Resistance, Junction to Case @ 85°C	$R_{\theta JC}$	27.3	$^\circ\text{C}/\text{W}$

Table 3. ESD Protection Characteristics

Test Conditions	Class
Human Body Model	0 (Minimum)
Machine Model	M1 (Minimum)
Charge Device Model	C2 (Minimum)

Table 4. Moisture Sensitivity Level

Test Methodology	Rating	Package Peak Temperature	Unit
Per JESD 22-A113, IPC/JEDEC J-STD-020	3	260	$^\circ\text{C}$

Table 5. Electrical Characteristics ($T_C = 25^\circ\text{C}$ unless otherwise noted)

Characteristic	Symbol	Min	Typ	Max	Unit
Off Characteristics					
Zero Gate Voltage Drain Current ($V_{DS} = 65\text{ Vdc}$, $V_{GS} = 0\text{ Vdc}$)	I_{DSS}	—	—	10	μAdc
Zero Gate Voltage Drain Current ($V_{DS} = 28\text{ Vdc}$, $V_{GS} = 0\text{ Vdc}$)	I_{DSS}	—	—	10	μAdc
Gate-Source Leakage Current ($V_{GS} = 5\text{ Vdc}$, $V_{DS} = 0\text{ Vdc}$)	I_{GSS}	—	—	1	μAdc
On Characteristics					
Gate Threshold Voltage ($V_{DS} = 10\text{ V}$, $I_D = 50\ \mu\text{A}$)	$V_{GS(th)}$	2	3	5	Vdc
Gate Quiescent Voltage ($V_{DS} = 28\text{ V}$, $I_D = 10\text{ mA}$)	$V_{GS(Q)}$	2	3.7	5	Vdc
Drain-Source On-Voltage ($V_{GS} = 10\text{ V}$, $I_D = 0.05\text{ A}$)	$V_{DS(on)}$	—	0.48	0.9	Vdc
Forward Transconductance ($V_{DS} = 10\text{ V}$, $I_D = 0.1\text{ A}$)	g_{fs}	—	0.05	—	S
Dynamic Characteristics					
Output Capacitance ($V_{DS} = 28\text{ Vdc} \pm 30\text{ mV(rms)ac}$ @ 1 MHz, $V_{GS} = 0\text{ Vdc}$)	C_{oss}	—	45	—	pF
Reverse Transfer Capacitance ($V_{DS} = 28\text{ Vdc} \pm 30\text{ mV(rms)ac}$ @ 1 MHz, $V_{GS} = 0\text{ Vdc}$)	C_{rss}	—	0.62	—	pF
Functional Tests (In Freescale Test Fixture, 50 ohm system)					
Two-Tone Common Source Amplifier Power Gain ($V_{DD} = 28\text{ Vdc}$, $P_{out} = 0.9\text{ W PEP}$, $I_{DQ} = 12\text{ mA}$, $f = 2170\text{ MHz}$, Tone Spacing = 100 kHz)	G_{ps}	—	13	—	dB
Two-Tone Drain Efficiency ($V_{DD} = 28\text{ Vdc}$, $P_{out} = 0.9\text{ W PEP}$, $I_{DQ} = 12\text{ mA}$, $f = 2170\text{ MHz}$, Tone Spacing = 100 kHz)	η_D	—	29	—	%
Third Order Intermodulation Distortion ($V_{DD} = 28\text{ Vdc}$, $P_{out} = 0.9\text{ W PEP}$, $I_{DQ} = 12\text{ mA}$, $f = 2170\text{ MHz}$, Tone Spacing = 100 kHz)	IMD	—	-28	—	dBc
Input Return Loss ($V_{DD} = 28\text{ Vdc}$, $P_{out} = 0.9\text{ W PEP}$, $I_{DQ} = 12\text{ mA}$, $f = 2170\text{ MHz}$, Tone Spacing = 100 kHz)	IRL	—	-18	—	dB
Output Power, 1 dB Compression Point, CW ($V_{DD} = 28\text{ Vdc}$, $I_{DQ} = 12\text{ mA}$, $f = 2170\text{ MHz}$)	P_{1dB}	—	0.85	—	W
Common-Source Amplifier Power Gain ($V_{DD} = 28\text{ Vdc}$, $P_{out} = 0.9\text{ W CW}$, $I_{DQ} = 12\text{ mA}$, $f = 2170\text{ MHz}$)	G_{ps}	12	13	—	dB
Drain Efficiency ($V_{DD} = 28\text{ Vdc}$, $P_{out} = 0.9\text{ W CW}$, $I_{DQ} = 12\text{ mA}$, $f = 2170\text{ MHz}$)	η_D	35	38	—	%
Input Return Loss ($V_{DD} = 28\text{ Vdc}$, $P_{out} = 0.9\text{ W CW}$, $I_{DQ} = 12\text{ mA}$, $f = 2170\text{ MHz}$)	IRL	-10	-16	—	dB

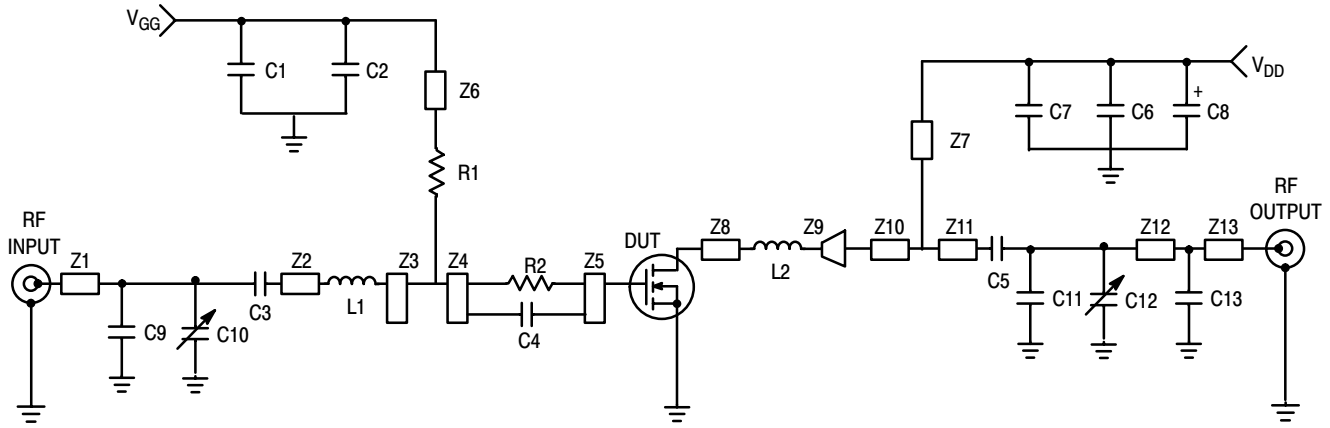

Z1	1.331" x 0.044" Microstrip	Z9	0.062" x 0.044" to 0.615" Taper
Z2	0.126" x 0.076" Microstrip	Z10	0.082" x 0.615" Microstrip
Z3	0.065" x 0.175" Microstrip	Z11	0.075" x 0.044" Microstrip
Z4	0.065" x 0.195" Microstrip	Z12	0.625" x 0.044" Microstrip
Z5	0.680" x 0.145" Microstrip	Z13	1.375" x 0.044" Microstrip
Z6, Z7	1.915" x 0.055" Microstrip	PCB	Rogers RO4350, 0.020", $\epsilon_r = 3.5$
Z8	0.120" x 0.141" Microstrip		

Figure 1. MW4IC001MR4 900 MHz Test Circuit Schematic

Table 6. MW4IC001MR4 900 MHz Test Circuit Component Designations and Values

Part	Description	Part Number	Manufacturer
C1, C6	0.1 μ F, 100 V Chip Capacitors	C1210C104K5RACTR	Kemet
C2, C3, C5, C7	43 pF, 500 V Chip Capacitors	100B430JP500X	ATC
C4	12 pF, 500 V Chip Capacitor	100B120JP500X	ATC
C8	22 μ F, 35 V Tantalum Chip Capacitor	T491X226K035AS	Kemet
C9	4.7 pF, 500 V Chip Capacitor	100B4R7CP500X	ATC
C10, C11	0.6-4.5 pF, 500 V Variable Capacitors	27271SL	Johanson
C12	2.7 pF, 500 V Chip Capacitor	100B2R7CP500X	ATC
C13	3.3 pF, 500 V Chip Capacitor	100B3R3CP500X	ATC
L1	5.6 nH Chip Inductor	0805 Series	AVX
L2	10 nH Chip Inductor	1008 Series	ATC
R1	100 Ω Chip Resistor	CRCW12061001F100	Dale
R2	20 Ω Chip Resistor	CRCW120620R0F100	Dale

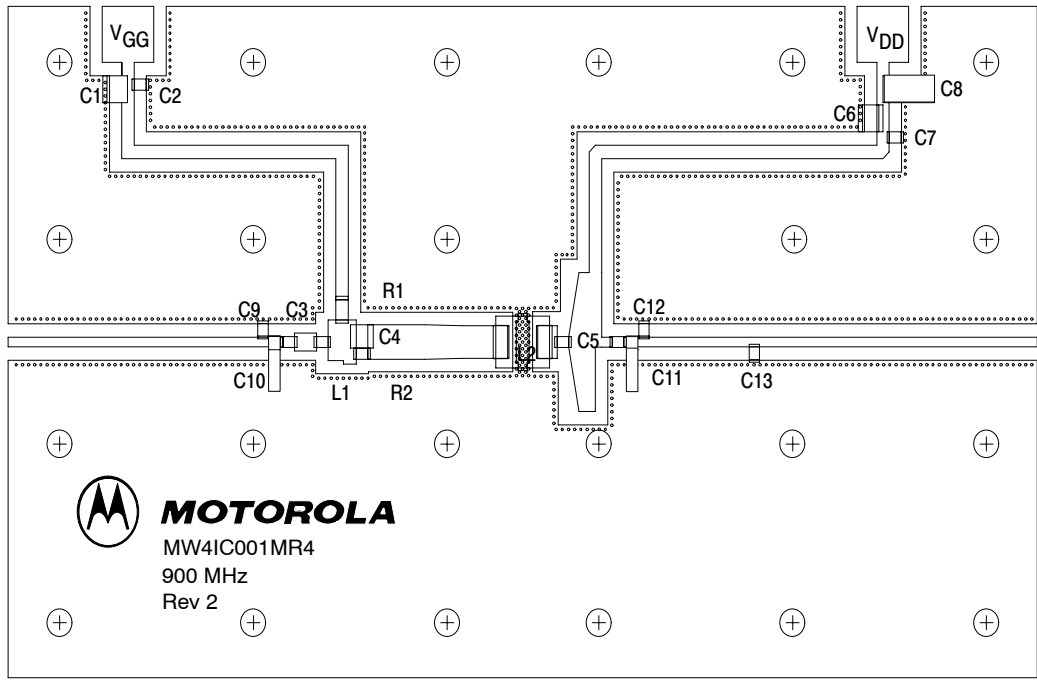

Freescale has begun the transition of marking Printed Circuit Boards (PCBs) with the Freescale Semiconductor signature/logo. PCBs may have either Motorola or Freescale markings during the transition period. These changes will have no impact on form, fit or function of the current product.

Figure 2. MW4IC001MR4 900 MHz Test Circuit Component Layout

TYPICAL CHARACTERISTICS - 900 MHz

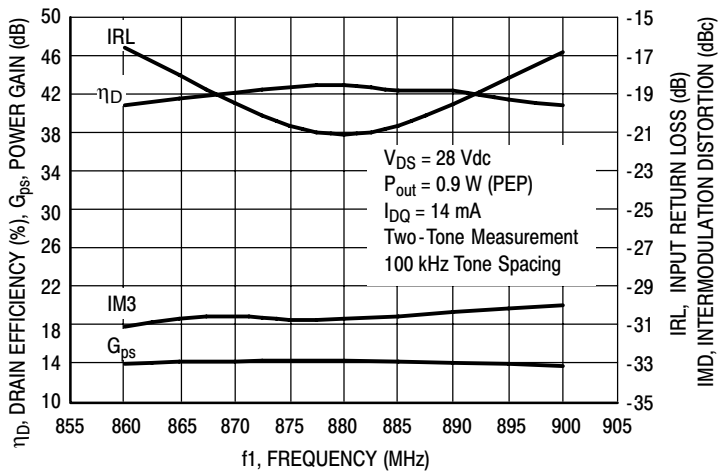

Figure 3. Two-Tone Performance versus Frequency

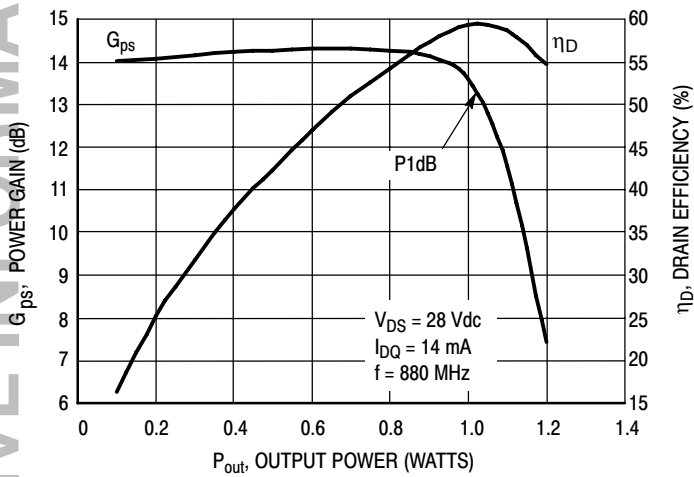

Figure 4. CW Performance versus Output Power

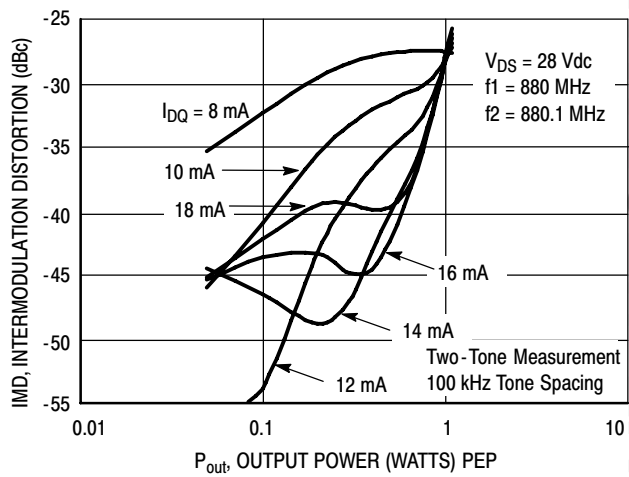

Figure 5. Intermodulation Distortion versus Output Power

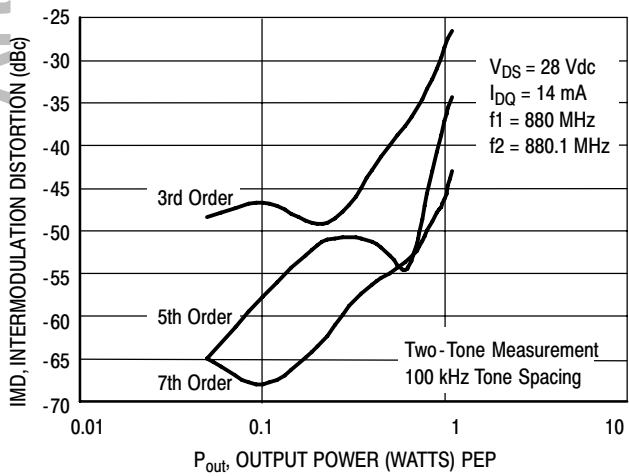

Figure 6. Intermodulation Distortion Products versus Output Power

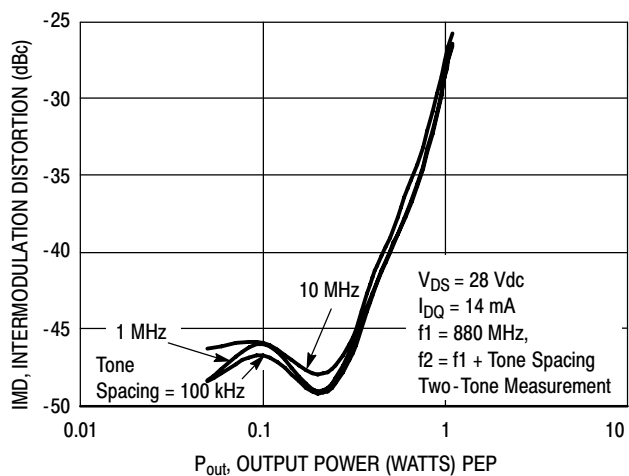
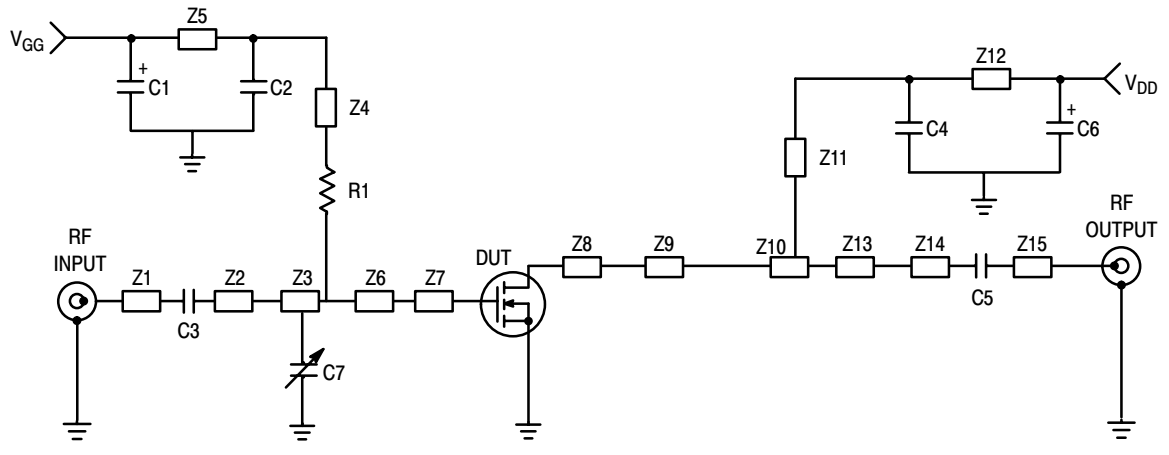

Figure 7. Third Order Intermodulation Distortion versus Output Power



Z1	1.018" x 0.044" Microstrip	Z9	0.067" x 0.264" Microstrip
Z2	0.495" x 0.296" Microstrip	Z10	0.457" x 0.492" Microstrip
Z3	0.893" x 0.500" Microstrip	Z11	0.719" x 0.022" Microstrip
Z4	1.340" x 0.022" Microstrip	Z12	1.149" x 0.022" Microstrip
Z5	0.912" x 0.022" Microstrip	Z13	0.677" x 0.434" Microstrip
Z6	0.241" x 0.500" Microstrip	Z14	0.095" x 0.264" Microstrip
Z7	0.076" x 0.150" Microstrip	Z15	0.772" x 0.044" Microstrip
Z8	0.294" x 0.150" Microstrip	PCB	Rogers RO4350, 0.020", $\epsilon_r = 3.5$

Figure 8. MW4IC001MR4 1990 MHz Test Circuit Schematic

Table 7. MW4IC001MR4 1990 MHz Test Circuit Component Designations and Values

Part	Description	Part Number	Manufacturer
C1, C6	22 μ F, 35 V Tantalum Capacitors	T491X226K035AS	Kemet
C2, C4	10 pF, 500 V Chip Capacitors	100B100JCA500X	ATC
C3, C5	10 pF, 500 V Chip Capacitor	600S100JW	ATC
C7	0.6-4.5 pF, 500 V Variable Capacitor	27271SL	Johanson
R1	1 k Ω Chip Resistor	CRCW12061021F100	Dale

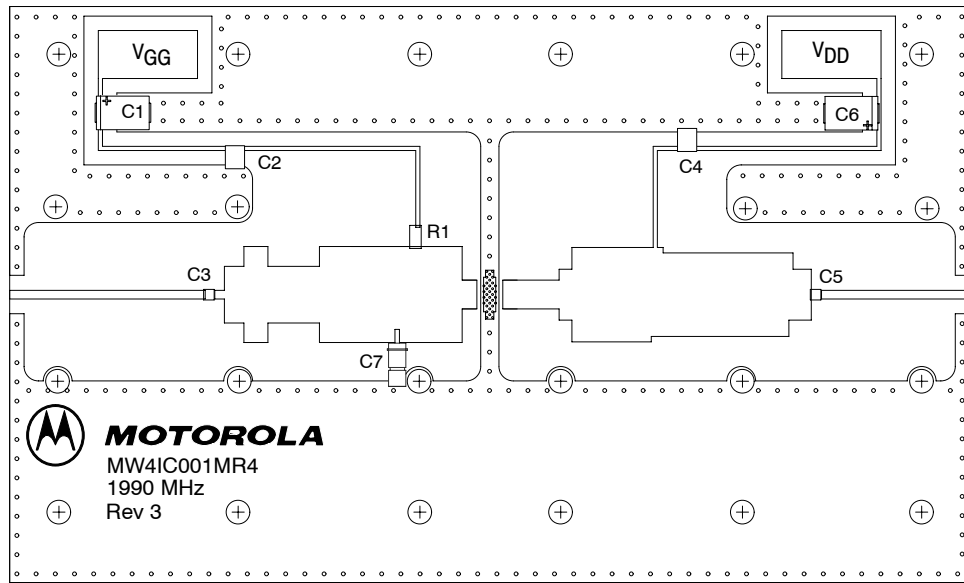

Freescale has begun the transition of marking Printed Circuit Boards (PCBs) with the Freescale Semiconductor signature/logo. PCBs may have either Motorola or Freescale markings during the transition period. These changes will have no impact on form, fit or function of the current product.

Figure 9. MW4IC001MR4 1990 MHz Test Circuit Component Layout

TYPICAL CHARACTERISTICS - 1990 MHz

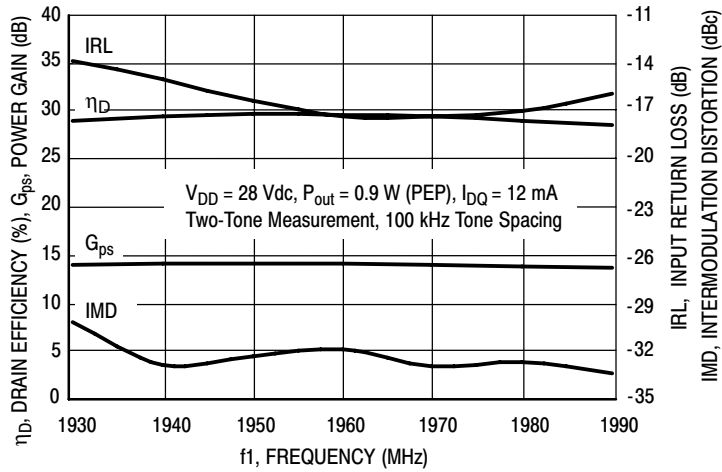

Figure 10. Two-Tone Performance versus Frequency

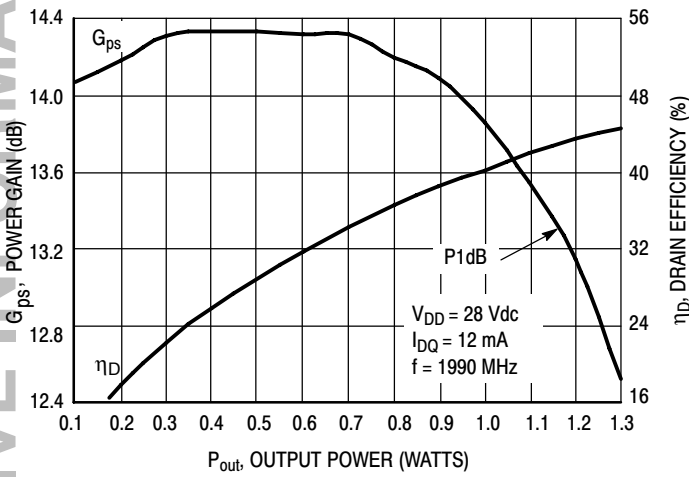

Figure 11. CW Performance versus Output Power

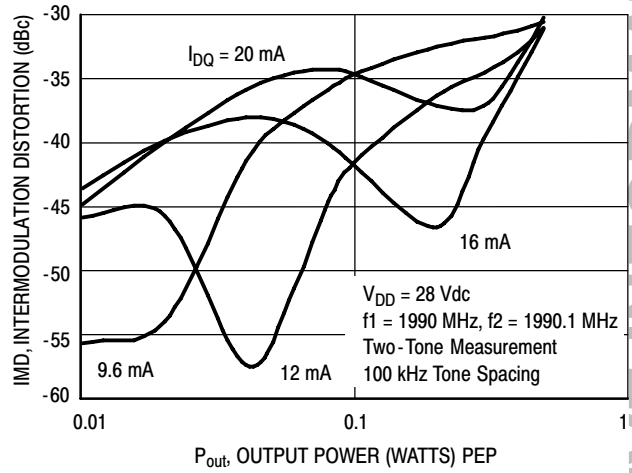

Figure 12. Intermodulation Distortion versus Output Power

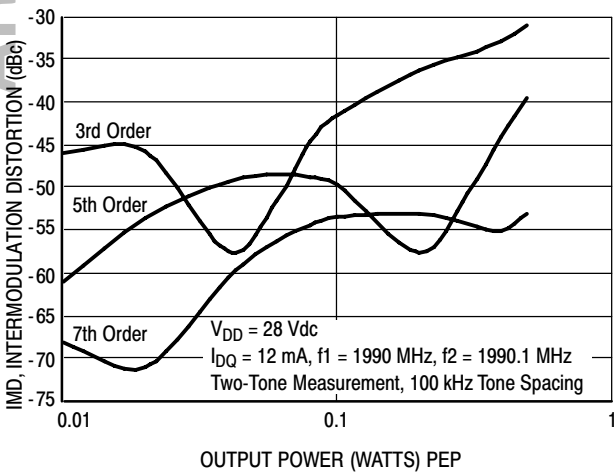

Figure 13. Intermodulation Distortion Products versus Output Power

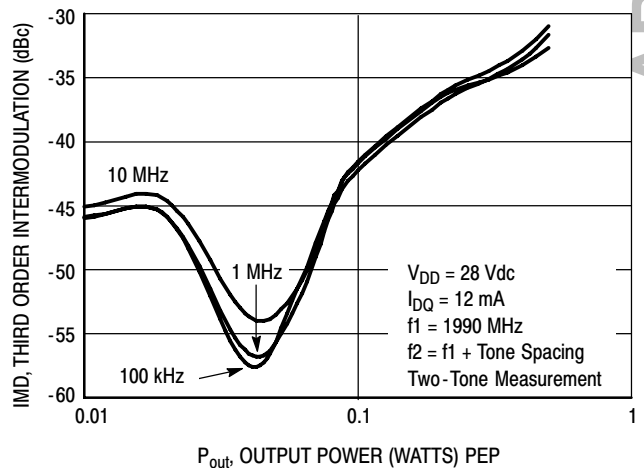
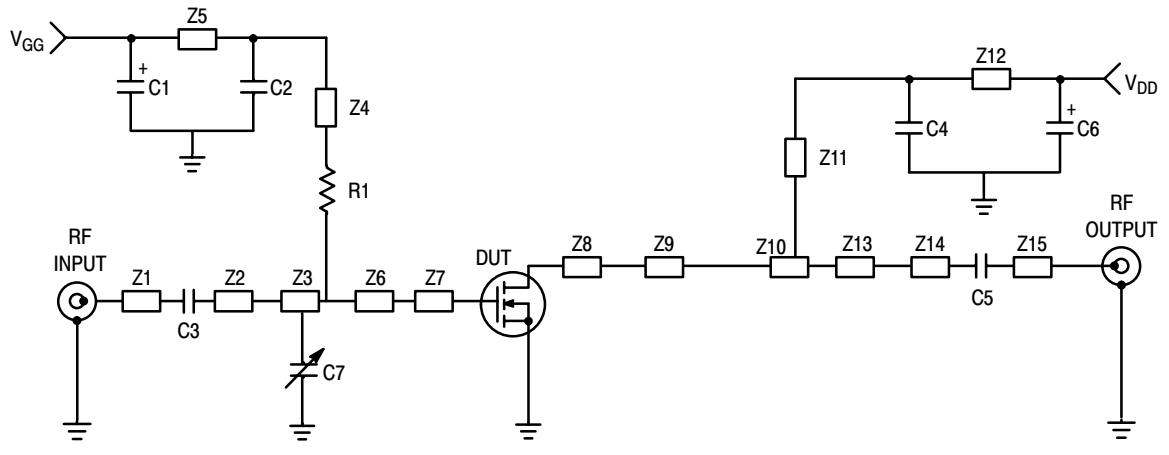

Figure 14. Third Order Intermodulation Distortion versus Output Power



Z1	1.267" x 0.044" Microstrip	Z9	0.106" x 0.344" Microstrip
Z2	0.058" x 0.044" Microstrip	Z10	0.783" x 0.500" Microstrip
Z3	0.758" x 0.256" Microstrip	Z11	0.847" x 0.022" Microstrip
Z4	1.073" x 0.022" Microstrip	Z12	1.055" x 0.022" Microstrip
Z5	1.361" x 0.022" Microstrip	Z13	0.291" x 0.387" Microstrip
Z6	0.205" x 0.332" Microstrip	Z14	0.050" x 0.287" Microstrip
Z7	0.109" x 0.150" Microstrip	Z15	0.950" x 0.044" Microstrip
Z8	0.210" x 0.150" Microstrip	PCB	Rogers RO4350, 0.020", $\epsilon_r = 3.5$

Figure 15. MW4IC001MR4 2170 MHz Test Circuit Schematic

Table 8. MW4IC001MR4 2170 MHz Test Circuit Component Designations and Values

Part	Description	Part Number	Manufacturer
C1, C6	22 μ F, 35 V Tantalum Capacitors	T491X226K035AS	Kemet
C2, C4	10 pF, 500 V Chip Capacitors	100B100JCA500X	ATC
C3, C5	10 pF, 500 V Chip Capacitor	600S100JW	ATC
C7	0.6-4.5 pF, 500 V Variable Capacitor	27271SL	Johanson
R1	1 k Ω Chip Resistor	CRCW12061021F100	Dale

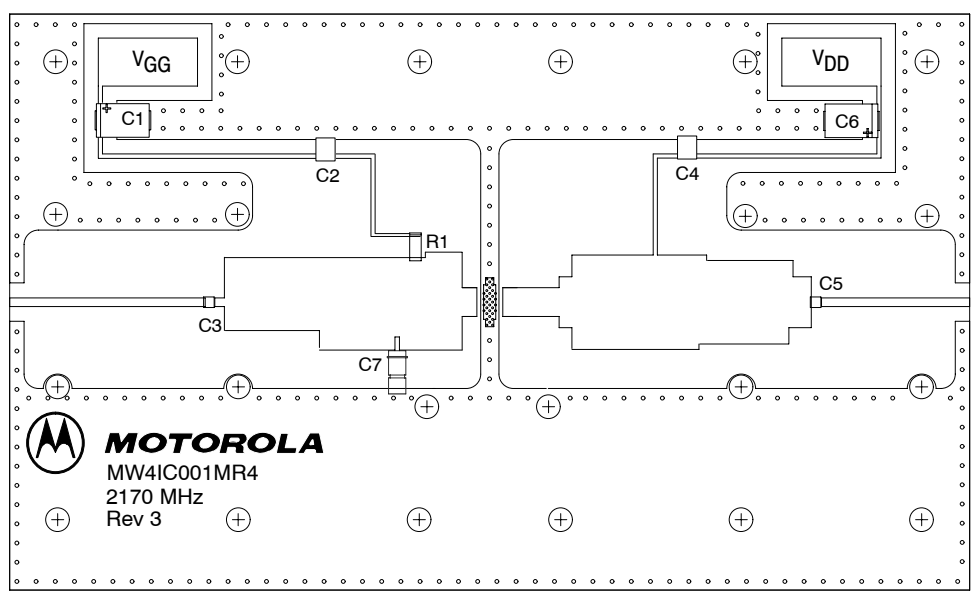

Freescale has begun the transition of marking Printed Circuit Boards (PCBs) with the Freescale Semiconductor signature/logo. PCBs may have either Motorola or Freescale markings during the transition period. These changes will have no impact on form, fit or function of the current product.

Figure 16. MW4IC001MR4 2170 MHz Test Circuit Component Layout

TYPICAL CHARACTERISTICS - 2170 MHz

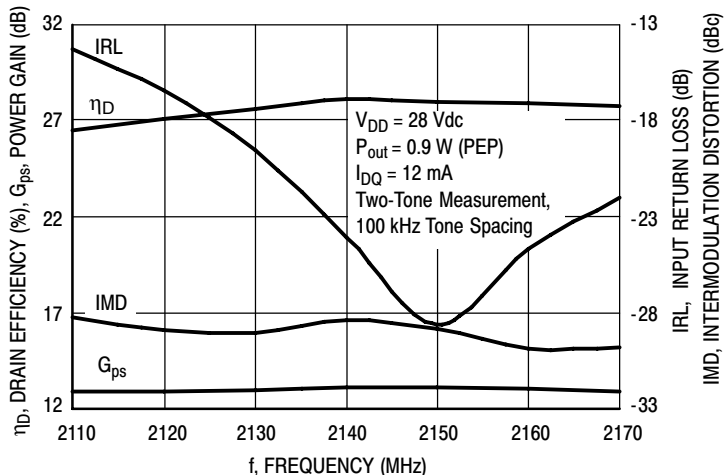

Figure 17. Two-Tone Performance versus Frequency

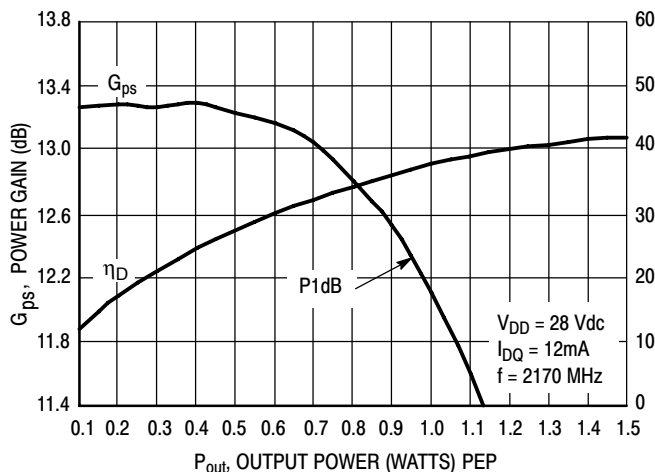

Figure 18. CW Performance versus Output Power

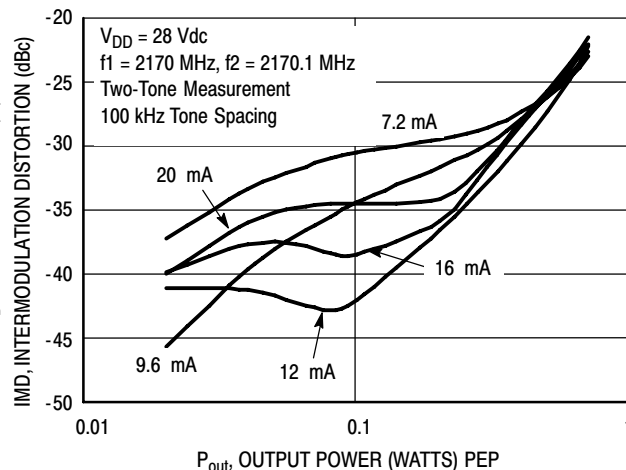

Figure 19. Intermodulation Distortion versus Output Power

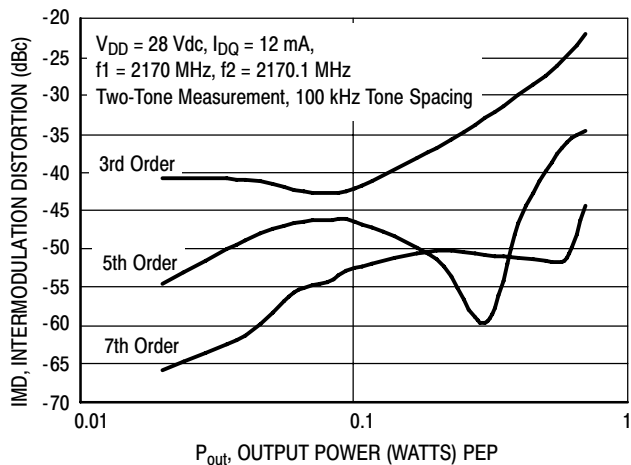

Figure 20. Intermodulation Distortion Products versus Output Power

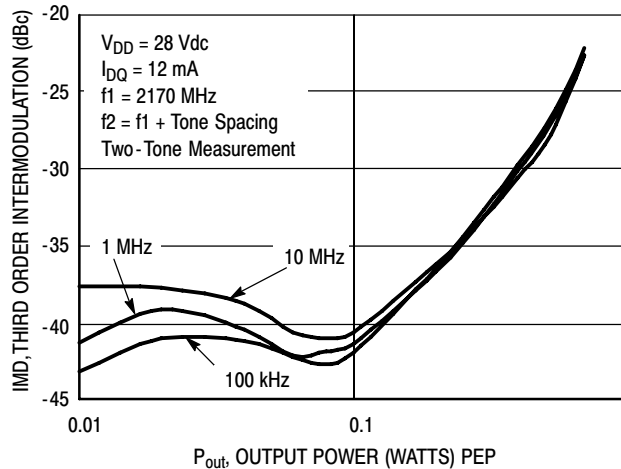
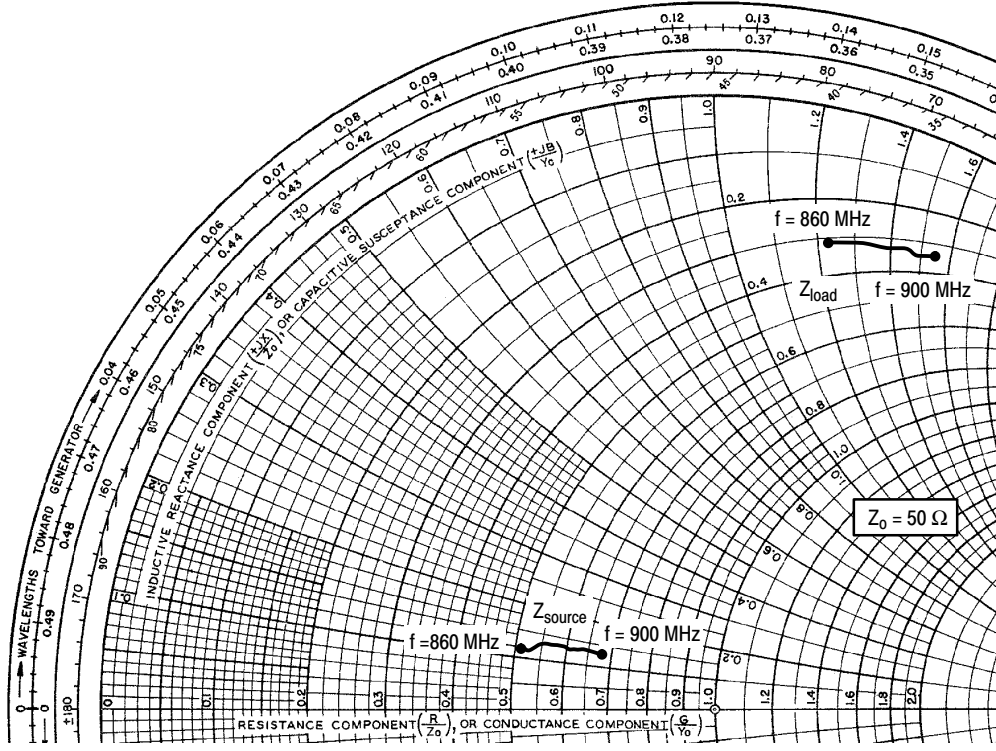

Figure 21. Third Order Intermodulation Distortion versus Output Power

ARCHIVE INFORMATION

ARCHIVE INFORMATION



$V_{DD} = 28\text{ V}$, $I_{DQ} = 14\text{ mA}$, $P_{out} = 0.9\text{ W PEP}$

f MHz	Z_{source} Ω	Z_{load} Ω
860	27.853 + j5.908	15.492 + j63.669
865	28.617 + j6.078	15.592 + j68.687
870	29.458 + j6.285	15.788 + j69.799
875	30.306 + j6.422	15.835 + j70.863
880	31.223 + j6.567	15.975 + j71.920
885	32.194 + j6.660	16.094 + j73.091
890	33.228 + j6.656	16.286 + j74.159
895	34.293 + j6.624	16.344 + j75.236
900	35.424 + j6.508	16.628 + j76.283

Z_{source} = Test circuit impedance as measured from gate to ground.

Z_{load} = Test circuit impedance as measured from drain to ground.

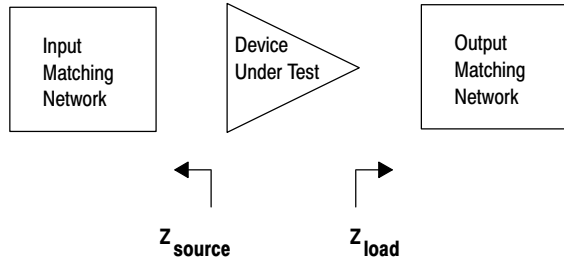
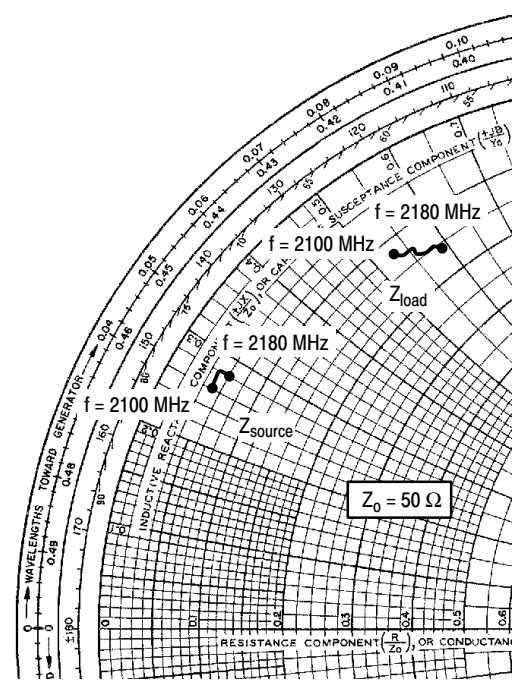
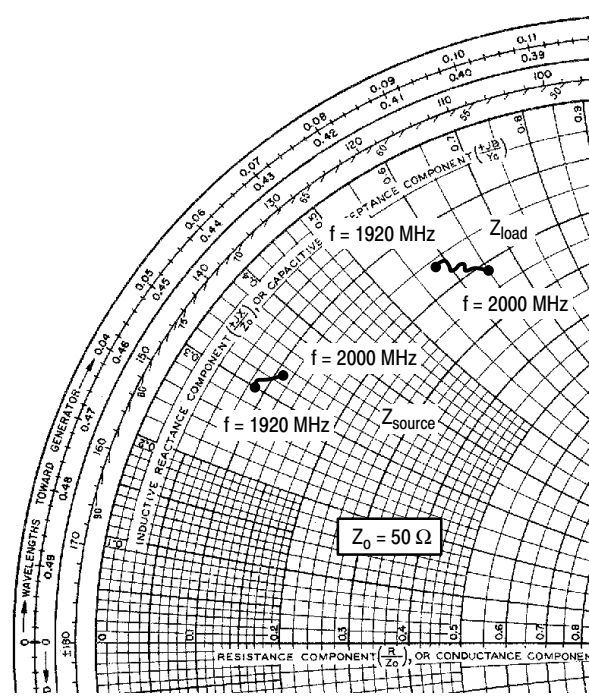

Figure 22. Series Equivalent Source and Load Impedance



$V_{DD} = 28\text{ V}$, $I_{DQ} = 12\text{ mA}$, $P_{out} = 0.9\text{ W PEP}$

f MHz	Z_{source} Ω	Z_{load} Ω
1920	4.238 + j15.142	7.764 + j28.829
1930	4.322 + j15.362	8.056 + j29.352
1940	4.490 + j15.466	8.436 + j29.727
1950	4.605 + j15.711	8.809 + j30.249
1960	4.752 + j15.904	9.183 + j30.763
1970	4.905 + j16.050	9.598 + j31.213
1980	5.071 + j16.236	10.030 + j31.690
1990	5.262 + j16.446	10.546 + j32.237
2000	5.487 + j16.632	11.054 + j32.726

Z_{source} = Test circuit impedance as measured from gate to ground.

Z_{load} = Test circuit impedance as measured from drain to ground.

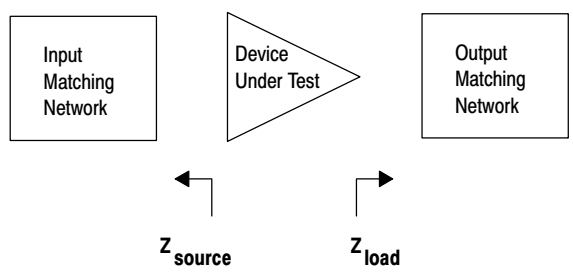

$V_{DD} = 28\text{ V}$, $I_{DQ} = 12\text{ mA}$, $P_{out} = 0.9\text{ W PEP}$

f MHz	Z_{source} Ω	Z_{load} Ω
2100	2.667 + j12.903	5.892 + j26.374
2110	2.671 + j13.070	6.092 + j26.739
2120	2.664 + j13.224	6.281 + j27.094
2130	2.694 + j13.431	6.540 + j27.510
2140	2.703 + j13.511	6.748 + j27.795
2150	2.702 + j13.700	6.996 + j28.182
2160	2.745 + j13.952	7.300 + j28.678
2170	2.754 + j14.026	7.562 + j28.987
2180	2.784 + j14.206	7.862 + j29.411

Z_{source} = Test circuit impedance as measured from gate to ground.

Z_{load} = Test circuit impedance as measured from drain to ground.

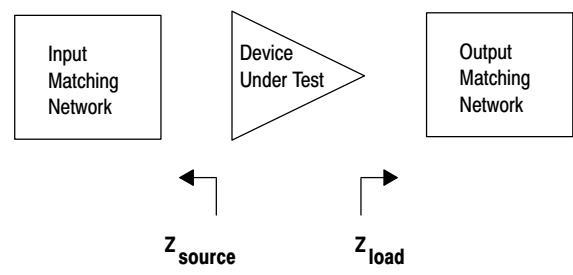

Figure 23. Series Equivalent Source and Load Impedance

ARCHIVE INFORMATION

ARCHIVE INFORMATION

ARCHIVE INFORMATION

ARCHIVE INFORMATION

ARCHIVE INFORMATION

ARCHIVE INFORMATION

PACKAGE DIMENSIONS

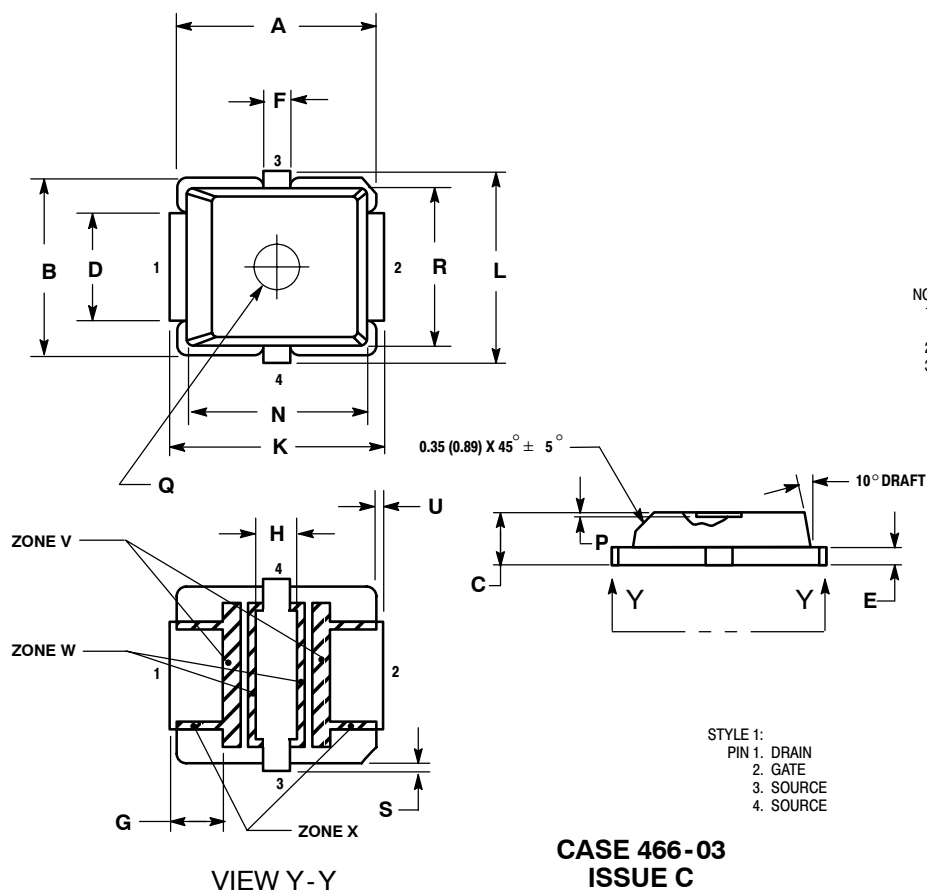

- NOTES:
1. INTERPRET DIMENSIONS AND TOLERANCES PER ASME Y14.5M, 1984.
 2. CONTROLLING DIMENSION: INCH
 3. RESIN BLEED/FLASH ALLOWABLE IN ZONE V, W, AND X.

DIM	INCHES		MILLIMETERS	
	MIN	MAX	MIN	MAX
A	0.255	0.265	6.48	6.73
B	0.225	0.235	5.72	5.97
C	0.065	0.072	1.65	1.83
D	0.130	0.150	3.30	3.81
E	0.021	0.026	0.53	0.66
F	0.026	0.044	0.66	1.12
G	0.050	0.070	1.27	1.78
H	0.045	0.063	1.14	1.60
J	0.160	0.180	4.06	4.57
K	0.273	0.285	6.93	7.24
L	0.245	0.255	6.22	6.48
N	0.230	0.240	5.84	6.10
P	0.000	0.008	0.00	0.20
Q	0.055	0.063	1.40	1.60
R	0.200	0.210	5.08	5.33
S	0.006	0.012	0.15	0.31
U	0.006	0.012	0.15	0.31
ZONE V	0.000	0.021	0.00	0.53
ZONE W	0.000	0.010	0.00	0.25
ZONE X	0.000	0.010	0.00	0.25

- STYLE 1:
1. DRAIN
 2. GATE
 3. SOURCE
 4. SOURCE

**CASE 466-03
ISSUE C
PLD-1.5
PLASTIC**

How to Reach Us:

Home Page:
www.freescale.com

E-mail:
support@freescale.com

USA/Europe or Locations Not Listed:
 Freescale Semiconductor
 Technical Information Center, CH370
 1300 N. Alma School Road
 Chandler, Arizona 85224
 +1-800-521-6274 or +1-480-768-2130
support@freescale.com

Europe, Middle East, and Africa:
 Freescale Halbleiter Deutschland GmbH
 Technical Information Center
 Schatzbogen 7
 81829 Muenchen, Germany
 +44 1296 380 456 (English)
 +46 8 52200080 (English)
 +49 89 92103 559 (German)
 +33 1 69 35 48 48 (French)
support@freescale.com

Japan:
 Freescale Semiconductor Japan Ltd.
 Headquarters
 ARCO Tower 15F
 1-8-1, Shimo-Meguro, Meguro-ku,
 Tokyo 153-0064
 Japan
 0120 191014 or +81 3 5437 9125
support.japan@freescale.com

Asia/Pacific:
 Freescale Semiconductor Hong Kong Ltd.
 Technical Information Center
 2 Dai King Street
 Tai Po Industrial Estate
 Tai Po, N.T., Hong Kong
 +800 2666 8080
support.asia@freescale.com

For Literature Requests Only:
 Freescale Semiconductor Literature Distribution Center
 P.O. Box 5405
 Denver, Colorado 80217
 1-800-441-2447 or 303-675-2140
 Fax: 303-675-2150
LDCForFreescaleSemiconductor@hibbertgroup.com

RoHS-compliant and/or Pb-free versions of Freescale products have the functionality and electrical characteristics of their non-RoHS-compliant and/or non-Pb-free counterparts. For further information, see <http://www.freescale.com> or contact your Freescale sales representative.

For information on Freescale's Environmental Products program, go to <http://www.freescale.com/epp>.

Information in this document is provided solely to enable system and software implementers to use Freescale Semiconductor products. There are no express or implied copyright licenses granted hereunder to design or fabricate any integrated circuits or integrated circuits based on the information in this document.

Freescale Semiconductor reserves the right to make changes without further notice to any products herein. Freescale Semiconductor makes no warranty, representation or guarantee regarding the suitability of its products for any particular purpose, nor does Freescale Semiconductor assume any liability arising out of the application or use of any product or circuit, and specifically disclaims any and all liability, including without limitation consequential or incidental damages. "Typical" parameters that may be provided in Freescale Semiconductor data sheets and/or specifications can and do vary in different applications and actual performance may vary over time. All operating parameters, including "Typicals", must be validated for each customer application by customer's technical experts. Freescale Semiconductor does not convey any license under its patent rights nor the rights of others. Freescale Semiconductor products are not designed, intended, or authorized for use as components in systems intended for surgical implant into the body, or other applications intended to support or sustain life, or for any other application in which the failure of the Freescale Semiconductor product could create a situation where personal injury or death may occur. Should Buyer purchase or use Freescale Semiconductor products for any such unintended or unauthorized application, Buyer shall indemnify and hold Freescale Semiconductor and its officers, employees, subsidiaries, affiliates, and distributors harmless against all claims, costs, damages, and expenses, and reasonable attorney fees arising out of, directly or indirectly, any claim of personal injury or death associated with such unintended or unauthorized use, even if such claim alleges that Freescale Semiconductor was negligent regarding the design or manufacture of the part.

Freescale™ and the Freescale logo are trademarks of Freescale Semiconductor, Inc. All other product or service names are the property of their respective owners.
 © Freescale Semiconductor, Inc. 2006. All rights reserved.

RoHS-compliant and/or Pb-free versions of Freescale products have the functionality and electrical characteristics of their non-RoHS-compliant and/or non-Pb-free counterparts. For further information, see <http://www.freescale.com> or contact your Freescale sales representative.

For information on Freescale's Environmental Products program, go to <http://www.freescale.com/epp>.