

Package	Silicone Package type Outer dimension 4.6 x 4.6 x 0.67mm (L x W x H)
Product features	<ul style="list-style-type: none"> • High efficiency 129lm/W White color emitting LED (5,000K,Ra70) • Low Thermal resistance product 9°C/W • Lead-free soldering compatible • RoHS compliant

Recommended Applications

- Residential lighting, Office lighting, Plant lighting, Store lighting, other general lighting

Outline Dimensions

GSPW1641NSE-50X-TR

Unit : mm
 Weight : 28.5mg
 Tolerance : ±0.1

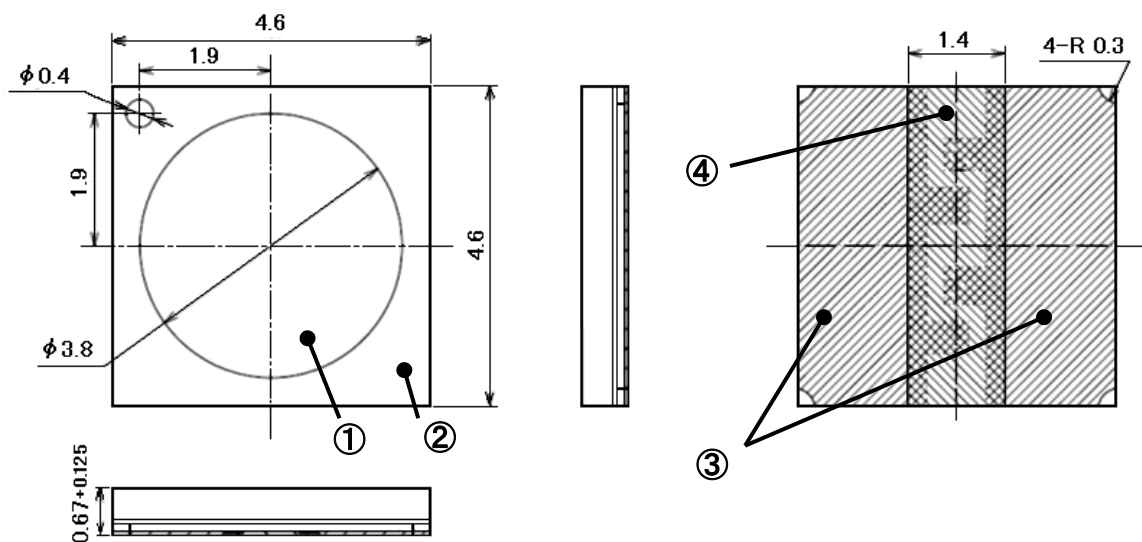

【Inside Circuit】

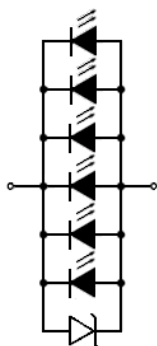

No.	Part Name	Material	QTY.
—	LED Die	InGaN	6
	Protection Diode	Si	1
①	Encapsulant	Silicone Resin	1
②	Lamp housing	Silicone Resin	1
③	Electrode	Ag Plating	2
④	Solder resist	Resin	1

Recommended Soldering Pattern

Unit : mm

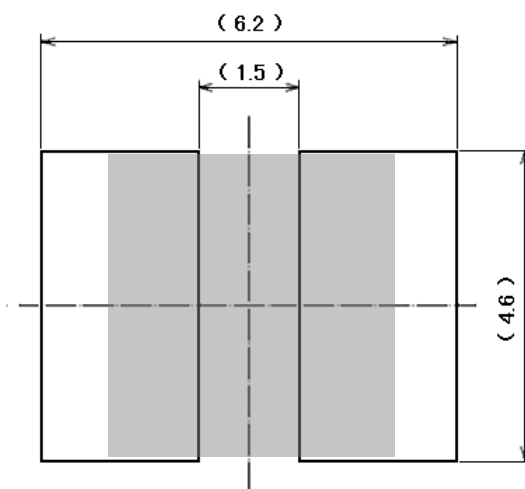

【 Product Overview 】

Die Material	InGaN
Emitting Color	White
Resin Color 【Emitting Area】	Diffused Pale Orange
Lamp Housing Color	White

【 Absolute Maximum Ratings 】

ITEM	SYMBOL	MAXIMUM RATINGS	UNITS	
Power Dissipation	P_d	2,310	mW	
Forward Current	I_F	600	mA	
I_F Derate Linearly from "Ts=90°C"	ΔI_F	20	mA/°C	
Allowable Reverse Current	I_R	85	mA	
Operating Temperature	T_{opr}	-30 ~ +85	°C	Notes 1
Storage Temperature	T_{stg}	-30 ~ +100	°C	Notes 1
Electrostatic Discharge Threshold "HBM"	ESD	1,000	V	Notes 2
Junction Temperature	T_j	125	°C	
Solder Point Temperature	T_s	100	°C	Notes 3
Soldering Temperature "Reflow Soldering"	T_{sld}	260	°C	Notes 4

Notes 1 The range of operating and storage temperature is not taping condition.

Notes 2 ESD testing methode : EIAJ4701/300(304) HBM 1.5KΩ, 100pF

Notes 3 Junction - solder point (measurement point)

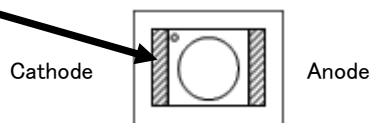

Noted 4 Please refer to attached sheets soldering conditions.

【 Thermal Characteristics 】

ITEM	SYMBOL	MIN.	TYP.	MAX.	UNITS	
Thermal resistance 【Junction - solder point】	$R_{th(j-s)}$	-	9	-	°C/W	Notes 3

【 Electro-Optical Characteristics 】

(Ta=25°C)

ITEM	SYMBOL	CONDITIONS	MIN.	TYP.	MAX.	UNITS	
Forward Voltage	V_F	$I_F = 350\text{mA}$	2.75	3.00	3.50	V	
Reverse Voltage	V_R	$I_R = 10\text{mA}$	0.6	-	1.1	V	Notes 5
Luminous Flux	Φ_v	$I_F = 350\text{mA}$	110	135	150	lm	Notes 6
Luminous Flux 【@85°C】	Φ_v	$I_F = 350\text{mA}$	-	117	-	lm	Notes 7
Efficiency	-	$I_F = 350\text{mA}$	-	129	-	lm/W	
Chromaticity Coordinates	x	$I_F = 350\text{mA}$	-	0.345	-	/	Notes 8,9
	y	$I_F = 350\text{mA}$	-	0.355	-		
Half Intensity Angle	$\Delta \theta_x$	$I_F = 350\text{mA}$	-	115	-	deg.	Notes 10
	$\Delta \theta_y$		-	115	-		
General Color Rendering Index	Ra	$I_F = 350\text{mA}$	-	70	-	/	
Color Temperature	-	$I_F = 350\text{mA}$	-	5,000	-	K	

- Notes 5 Please do not input reverse voltage for prevent the destruction by static electricity.
- Notes 6,8 Please refer to the attached sheets, each sorting chart.
- Notes 7 Luminous flux at 85°C(junction temperature)
- Notes 9 Chromaticity coordinates : x and y according to CIE1931.
- Notes 10 Viewing Angle at 50% I_v , $\Delta \theta_x$, θ_y , as shown in the right tside figure.

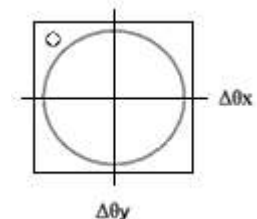

【 Sorting Chart for Luminous Flux ϕ_v 】

LEDs shall be sorted out into the following chart and each rank parts shall be pscked separately when shipping.

(Ta=25°C)

Rank	Luminous Flux Φ_v (lm)		Condition
	MIN.	MAX.	
GB	110	120	$I_F = 350\text{mA}$
GC	120	130	
GD	130	140	
GE	140	150	

Notes Tolerance each rank : ±10%

【 Sorting chart For Chromaticity coordinates 】

Chromaticity coordinates shall be sorted out into the following chart and each rank parts shall be packed separately when shipping.

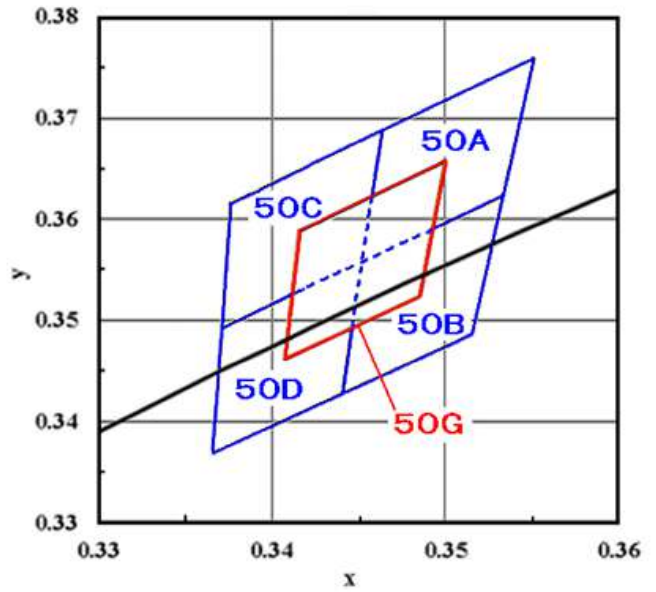
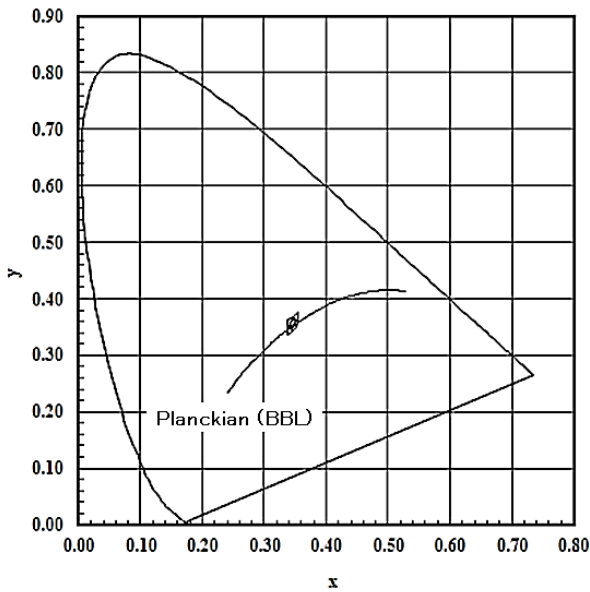

General color temperature
5,000K (4,745K~5,311K)

(Ta=25°C If=350mA)

Rank	x	y	Rank	x	y	Rank	x	y	Rank	x	y
50A	0.3452	0.3558	50B	0.3441	0.3428	50C	0.3371	0.3493	50D	0.3366	0.3369
	0.3464	0.3688		0.3452	0.3558		0.3376	0.3616		0.3371	0.3493
	0.3551	0.3760		0.3533	0.3624		0.3464	0.3688		0.3452	0.3558
	0.3533	0.3624		0.3515	0.3487		0.3452	0.3558		0.3441	0.3428

Rank	x	y
50G	0.3407	0.3462
	0.3416	0.3589
	0.3500	0.3657
	0.3485	0.3524

Notes

- Chromaticity coordinates Tolerance each rank : ±0.01
- Chromaticity rank will ship by 5 ranks (A, B, C, D, and G).
- **Rank G will overlap with Rank A,B,C,D.**

【 Sorting chart for Forward Voltage Characteristics, V_F 】

Forward Voltage shall be sorted out into the following chart and each rank parts shall be packed separately when shipping.

($T_a=25^{\circ}\text{C}$)

Rank	V_F (V)		Condition
	MIN.	MAX.	
A	2.75	3.00	$I_F=350\text{mA}$
B	3.00	3.25	
C	3.25	3.50	

Note: Tolerance each Rank: $\pm 0.1\text{V}$

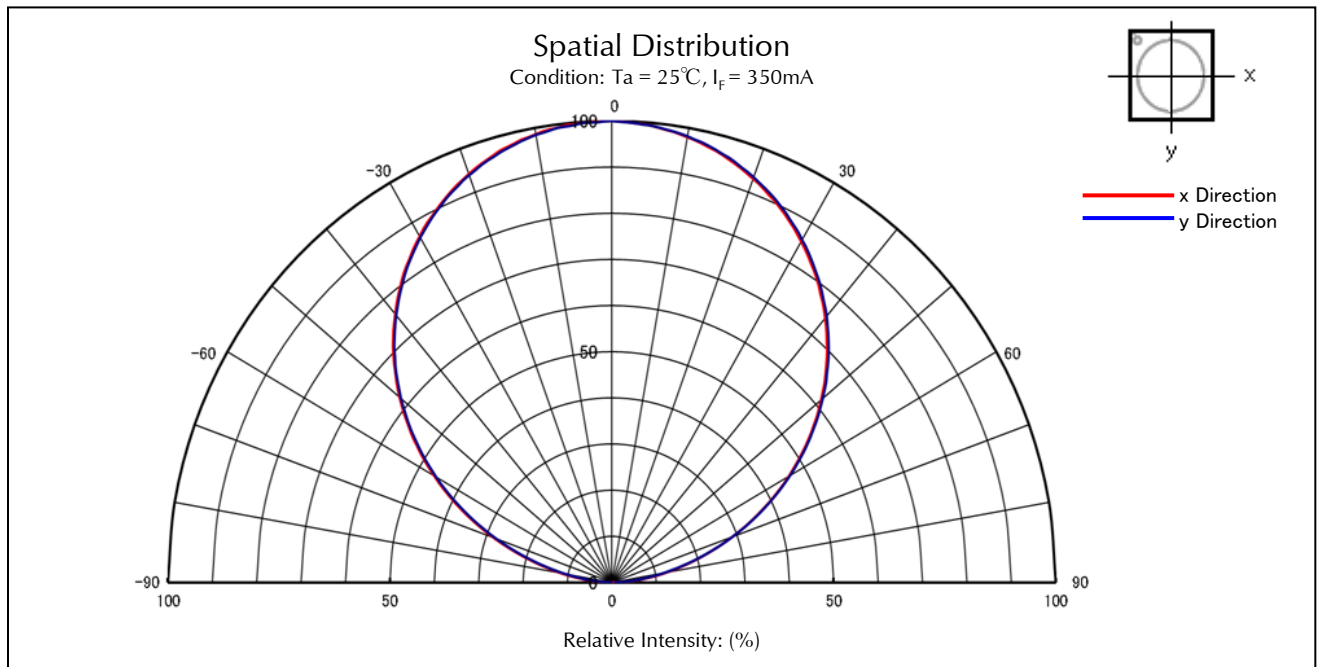
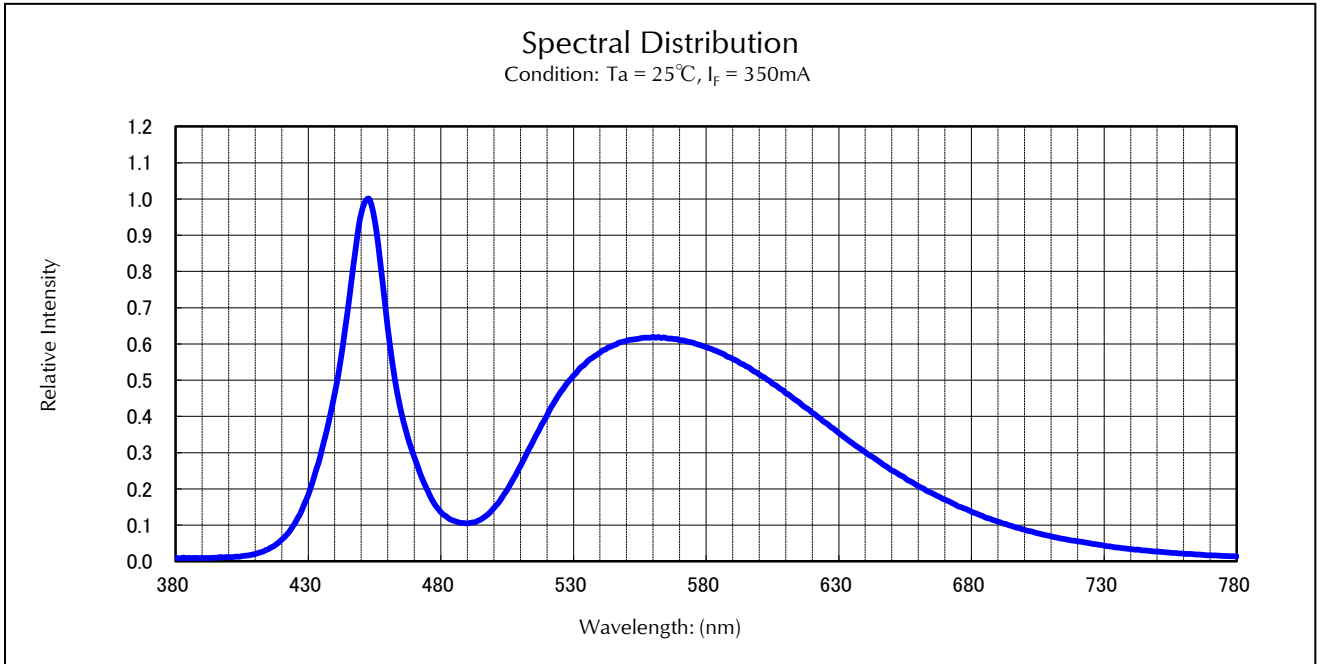

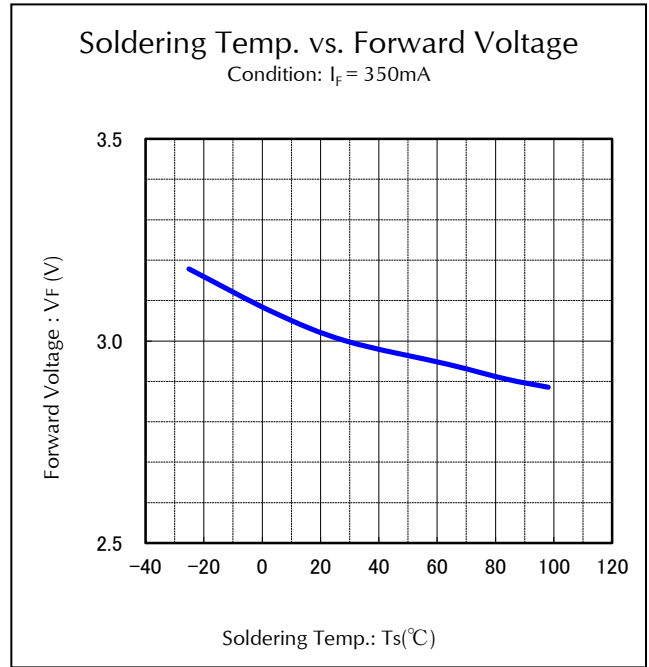
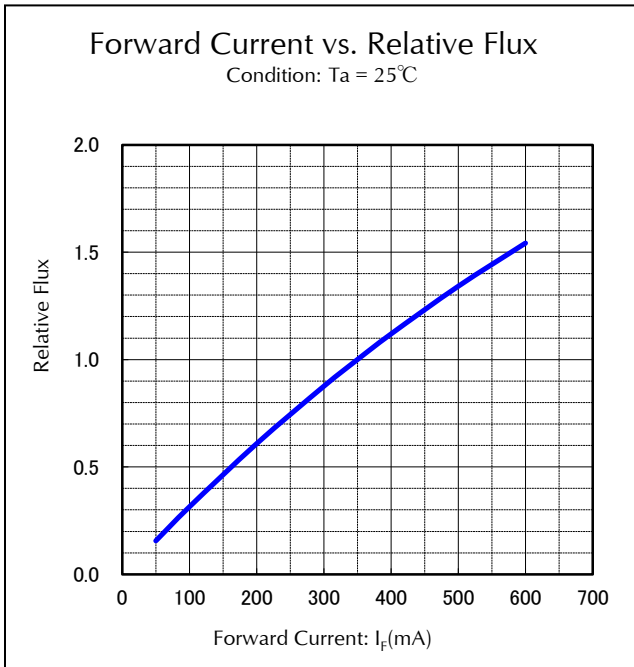
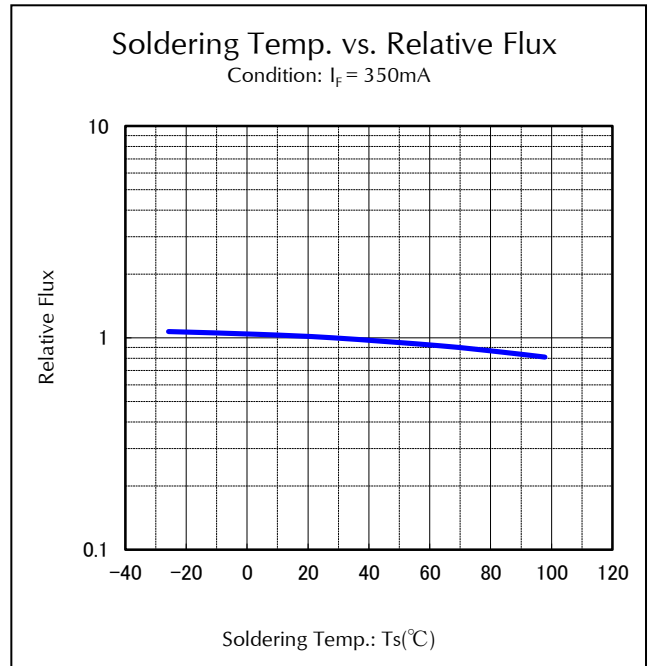
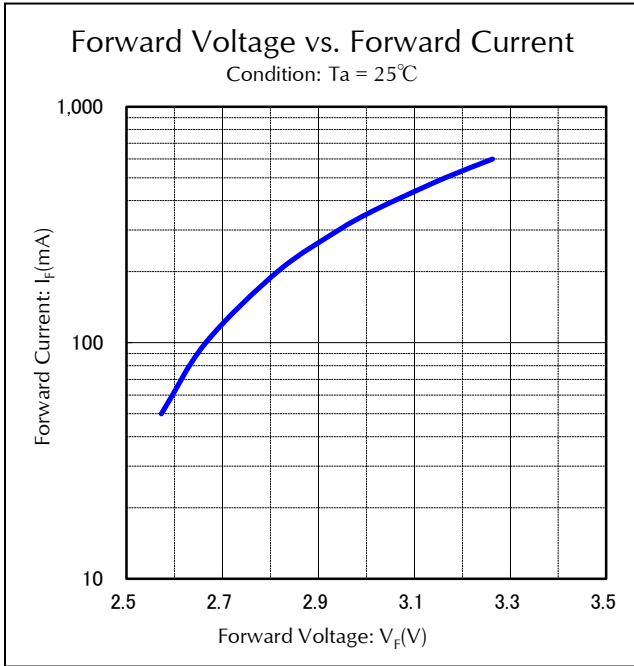

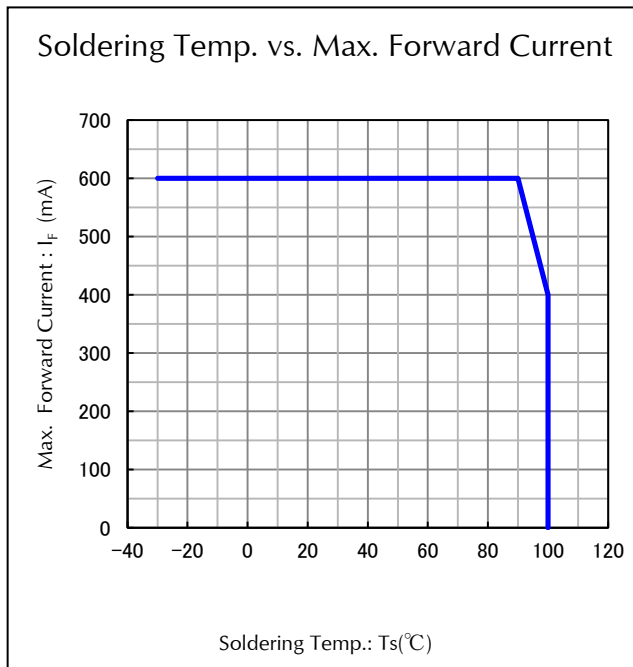
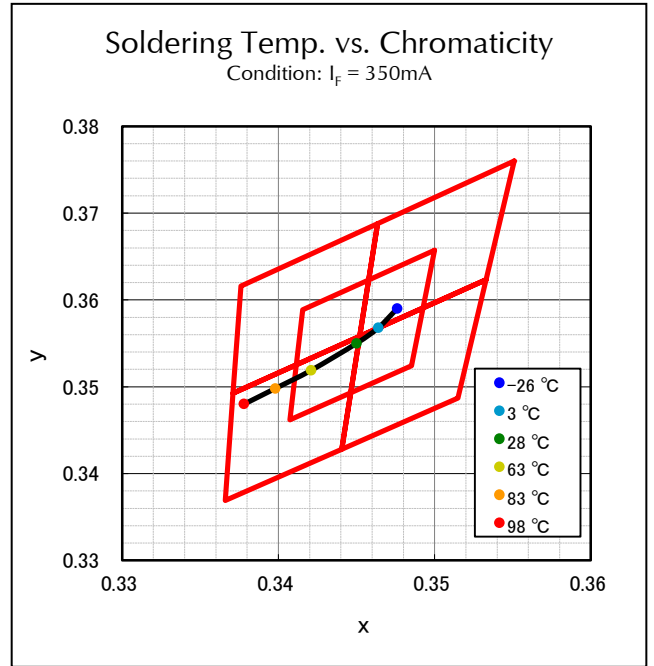
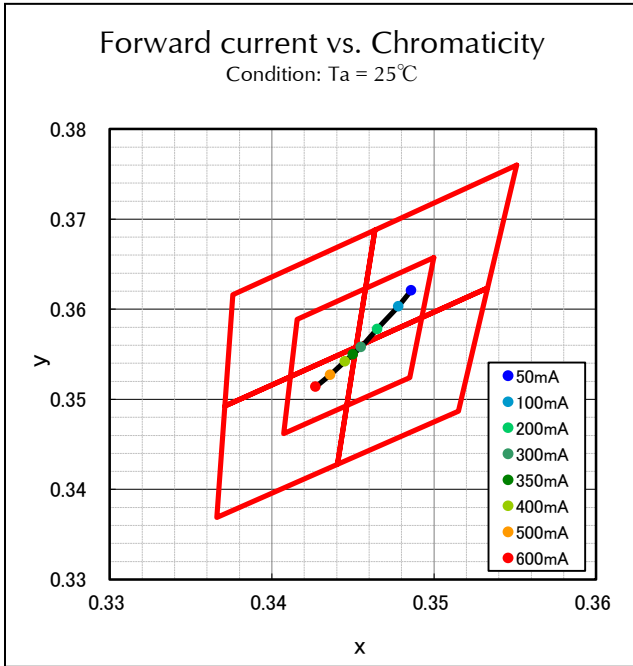

【Soldering Precaution】

(acc.to EIAJ-4701/300)

1. Heat stress during soldering will influence the reliability of LEDs, however that effect will vary on heating method. Also, if components of varying shape are soldered together, it is recommended to set the soldering pad temperature according to the component most vulnerable to heat (e.g., surface mount LED).
2. LED parts including the resin are not stable immediately after soldering (when they are not at room temperature), any mechanical stress may cause damage to the product. Please avoid such stress after soldering, especially stacking of the boards which may cause the boards to warp and any other types of friction with hard materials.
3. Recommended temperature profile for the Reflow soldering is listed as the temperature of the resin surface. Temperature distribution varies on heating method, PCB material, other components in the assembly, and mounting density .
Please do not repeat the heating process in Reflow process more than twice.

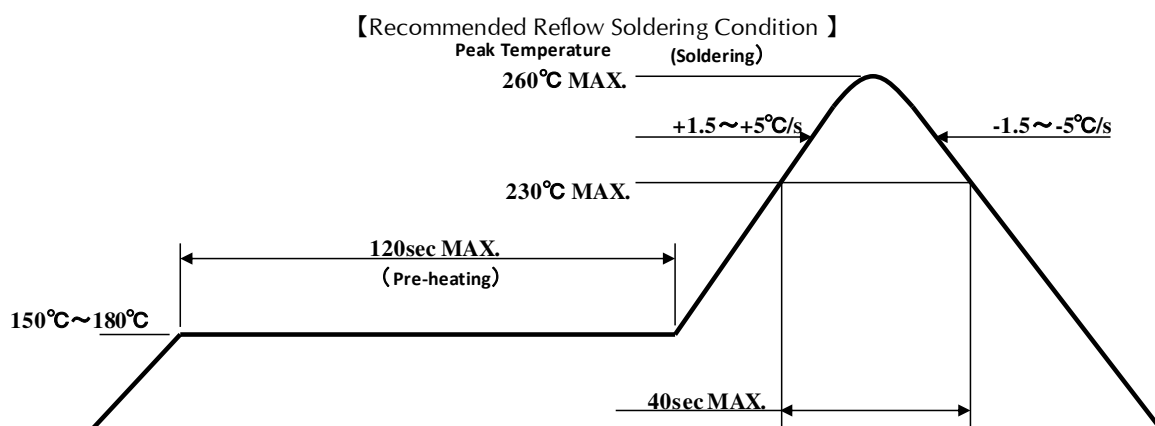

Note 1 Temperature Profile for the reflow should be set to the surface temperature of resin which is on the top of LED. This should be the maximum temperature for soldering. Lowering the heating temperature and decreasing heating time is very effective in achieving higher reliability.

Note 2 The reflow soldering process should be done up to twice(2 times Max). When second process is performed, interval between first and second process should be as short as possible to prevent absorption of moisture to resin of LED. The second soldering process should not be done until LEDs have returned to room temperature (by nature-cooling) after first soldering process.

4. If soldering manually, Stanley recommends using a soldering iron equipped with temperature control. During the actual soldering process, make sure that the soldering iron never touches the LED itself, and avoid the LED's electrode heating temperature reaching above the heating temperature of the solder pad. All repairs must be performed only once in the same spot, and please avoid reusing components.
5. In soldering process, immediately after iron tip is cleaned, please make sure that the soldering iron reaches the appropriate temperature before using. Also, please avoid applying any types of pressure to the soldered components before the solder has been cooled and hardened, as it may deteriorate solder performance and solder quality.

【Recommended Manual Soldering Condition】

Temperature of Iron Tip	350°C MAX.
Soldering Duration, Time	3sec. Max., 1 time

6. When using adhesive material for tentative fixatives, thermosetting resin or Ultraviolet radiation (UV) setting resin with heat shall be recommended.
《The curing condition, Temperature:150°C Max./Time:300sec. Max.》
7. Flow soldering (dip soldering) is not recommended for this product.
8. Isopropyl alcohol is recommended for cleaning. Some chemicals, including Freon substitute detergent could corrode the lens or the casing surface, which cause discoloration, cloud, crack and so on. Please review the reference chart below for cleaning. If water is used to clean (including the final cleaning process), please use pure water (not tap water), and completely dry the component. Cleaning with ultrasonic is not recommended.

Chemical	Adaptability
Ethyl Alcohol	○
Isopropyl Alcohol	○
Pure Water	○
Trichloroethylene	×
Chloroethene	×
Acetone	×
Thinner	×

【For Electric Static Discharge (ESD)】

This type of LED lamp is highly sensitive to surge voltage generated by the On/Off status change and discharges of static electricity through frictions with synthetic materials, which may cause severe damage to the die or undermine its reliability. Damaged products may experience conditions such as extremely high reverse voltage, or a decrease of forward rise voltage, deteriorating its optical characteristic.

Stanley products are designed to withstand up to 1,000V under the EIAJ ED-4701/300 Test #304 (HBM), and are packed with anti-static components. However, the following precautions and measures are vital in ensuring product quality during shipment.

EIAJ ED-4701/300(304/HBM) Electrification model: C=100pF, R2=1.5KΩ

1. Electrification/Static Electricity protection

Stanley recommends the following precautions in order to avoid product (die) damage from static electricity , when an operator and other materials electrified by friction coming in contact with the product.

- ① Do not place electrified non-conductive materials near the LED product.
Avoid LED products from coming into contact with metallic materials.(Should the metallic material be electrified , the sudden surge voltage will most likely damage the product.)
- ② Avoid a working process which may cause the LED product to rub against other materials.
- ③ Install ground wires for any equipment, where they can be installed, with measures to avoid static electricity surges.
- ④ Prepare a ESD protective area by placing a Conductive Mattress (1MΩ MAX.) and Ionizer to remove any static electricity.
- ⑤ Operators should wear a protective wrist-strap.
- ⑥ Operators should wear conductive work-clothes and shoes.
- ⑦ To handle the products directly, Stanley recommends the use of ceramic, and not metallic, tweezers.

2. Working Environment

- ① A dry environment is more likely to cause static electricity. Although a dry environment is ideal for storage state of LED products, Stanley recommends an environment with approximately 50% humidity after the soldering process.
- ② Recommended static electricity level in the working environment is 150V, which is the same value as Integrated Circuits (which are sensitive to static electricity).

【Other Precautions】

1. Stanley LED Lamps have semiconductor characteristics and are designed to ensure high reliability. However, the performance may vary depending on usage conditions.
2. Absolute Maximum Ratings are set to prevent LED lamps from failing due to excess stress(temperature, current, voltage, etc.). Usage conditions must not exceed the ratings for a moment, nor do reach one item of absolute maximum ratings simultaneously.
3. In order to ensure high reliability from LED Lamps, variable factors that arise in actual usage conditions should be taken it to account for designing. (Derating of TYP., MAX Forward Voltage, etc.)
4. Please insert Straight Protective Resistors into the circuit in order to stabilize LED operation and to prevent the device from igniting due to excess current.
5. Please be careful when LED is soldered on a metal plate, since solder crack might be caused by heat .
6. Please avoid using this product with materials or products that contain sulfur or chlorine element which may damage the product. Keep the product in desiccator regardless of before or after mounting to prevent corrosive gas. Also make sure there is no corrosive gas which occurs in surrounding area or invade from outside when using products.
7. Please avoid the stick of foreign material because molding resin in the products have adhesiveness. And please don't touch lens portion.
8. Please check the actual performance in the assembly because the Specification Sheets are described for LED device only.
9. Please refrain from looking directly at the light source of LED at high output, as it may harm your vision.
10. The products are designed to operate without failure in recommended usage conditions. However, please take the necessary precautions to prevent fire, injury, and other damages should any malfunction or failure arise.
11. The products are manufactured to be used for ordinary electronic equipment. Please contact our sales staff beforehand when exceptional quality and reliability are required, and the failure or malfunction of the products might directly jeopardize life or health (such as for airplanes, aerospace, transport equipment, medical applications, nuclear reactor control systems and so on).
12. The formal specification sheets shall be valid only by exchange of documents signed by both parties.

【 Handling Precautions for Product Mounting 】

<Recommendation>

Picking up point with nozzle : Lamp housing of the product ( area) (Shown below)

The pick up point is lamp housing only because the silicone resin used for the lens is soft. (If the nozzle makes contact with the lens, the products might be destroyed)

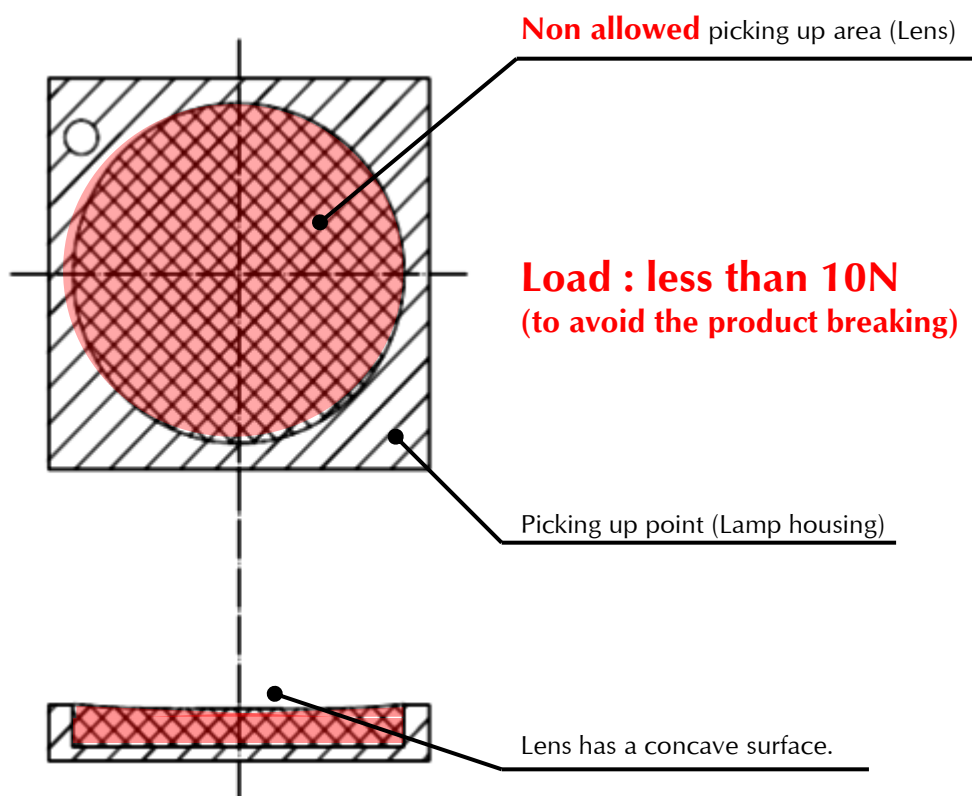

Please adjust the load, the pick up point, the nozzle diameter and etc. before mounting because the over load can cause the breakage of the lamp housing.

This product is baked (moisture removal) before packaging, and is shipped in moisture-proof packaging (as shown below) to minimize moisture absorption during transportation and storage. However, with regard to storing the products, Stanley recommends the use of dry-box under the following conditions is recommended. Moisture-proof bag as the packaging is made of anti-static material but packaging box is not.

【Recommended Storage Condition / Products Warranty Period】

Temperature	+5~30°C
Humidity	Under 70%

In the case of the package unopened , 6 months under 【 Recommended Storage Condition 】, Please avoid rapid transition from low temp. condition to high temp. condition and storage in corroding and dusty environment.

【Time elapsed after Package Opening】

If any LED remain unused, please put it back to moisture-proof bag, reseal the package and store it under the conditions described in the 【 Recommended Storage Condition 】,
When over 6 months passed after first opening of package, please do confirm the solder wettability of the terminals.

Baking (moisture removal) is not needed for this product.

Please do not bake LEDs with carrier tape.

【Moisture-proof Packaging Specification】

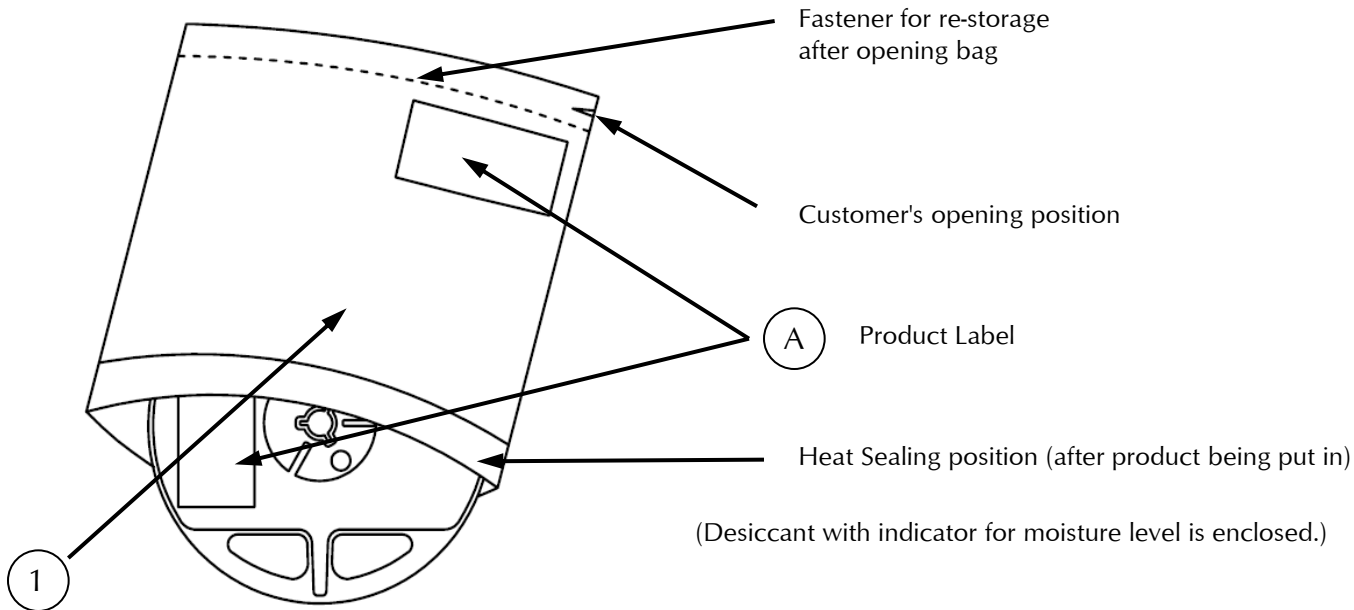

SYM.	PART NAME	MATELRIAL	REMARKS
①	Moisture-proof bag with Aluminum layer	PET+Al+PE	with ESD protection

【Packing box】

(RoHS•ELV Compliant)

Box TYPE	Outline dimension L × W × H (mm)	Capacity of the box
Type A	280 × 265 × 45	3 reels
Type B	310 × 235 × 265	15 reels
Type C	440 × 310 × 265	30 reels

The above measure is all the reference value.

Shipping box is selected out of the above table by shipping quantity.

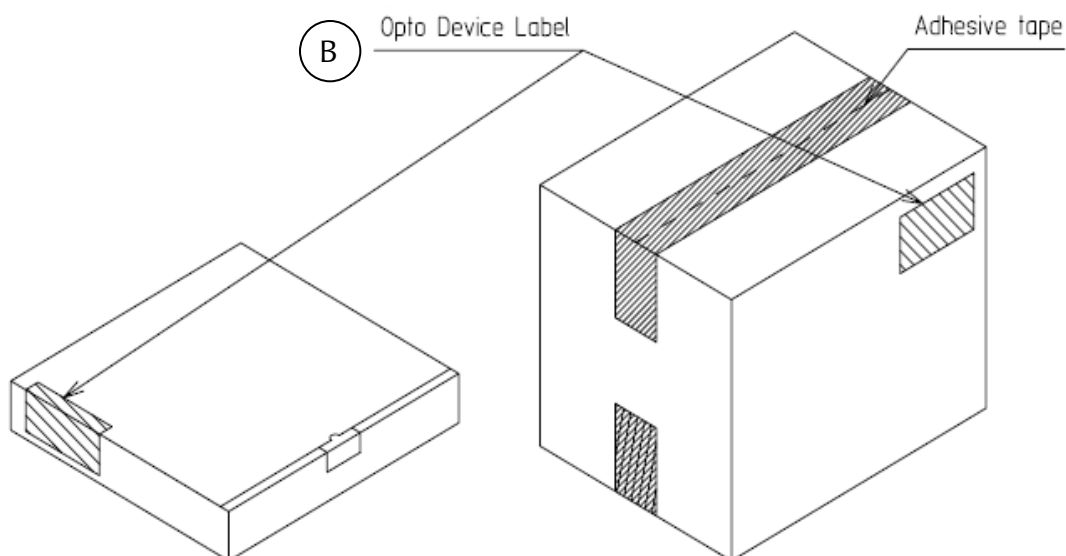

Type A

Material / box : Cardboard C5BF

Type B,C

Material / box : Cardboard K5AF
Partition : Cardboard K5AF

【Label Specification】

(acc.to JIS-X0503(Code-39))

(A) Product Label

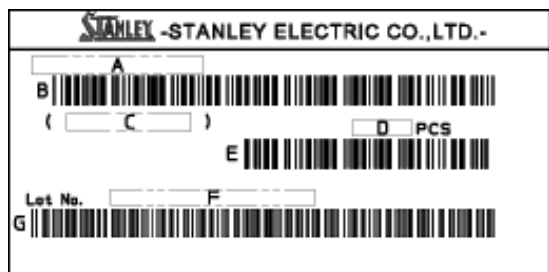

- A. Parts number
- B. Bar-code for parts number
- C. Parts code (In-house identification code for each parts number)
- D. Packed parts quantity
- E. Bar-Code for packed parts quantity
- F. Lot number & Rank
(refer to Lot Number Notational System for details)
- G. Bar-Code for Lot number & Rank

(B) Opto Device Label

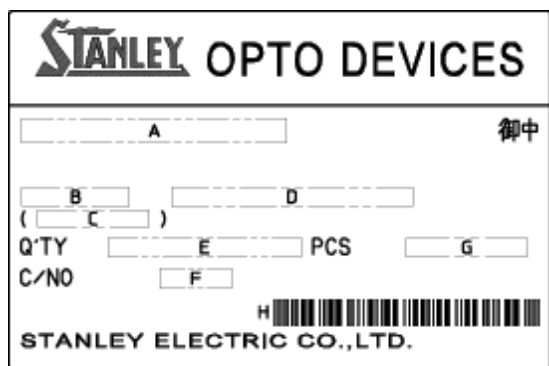

- A. Customer Name
- B. Parts Type
- C. Parts Code
- D. Parts Number
- E. Packed Parts Quantity
- F. Carton Number
- G. Shipping Date
- H. Bar-Code for In-house identification Number

<Remark> Bar-code font : acc.to Code-39(JIX0503)

(acc.to JIS-C0806-03)

【Appearance】

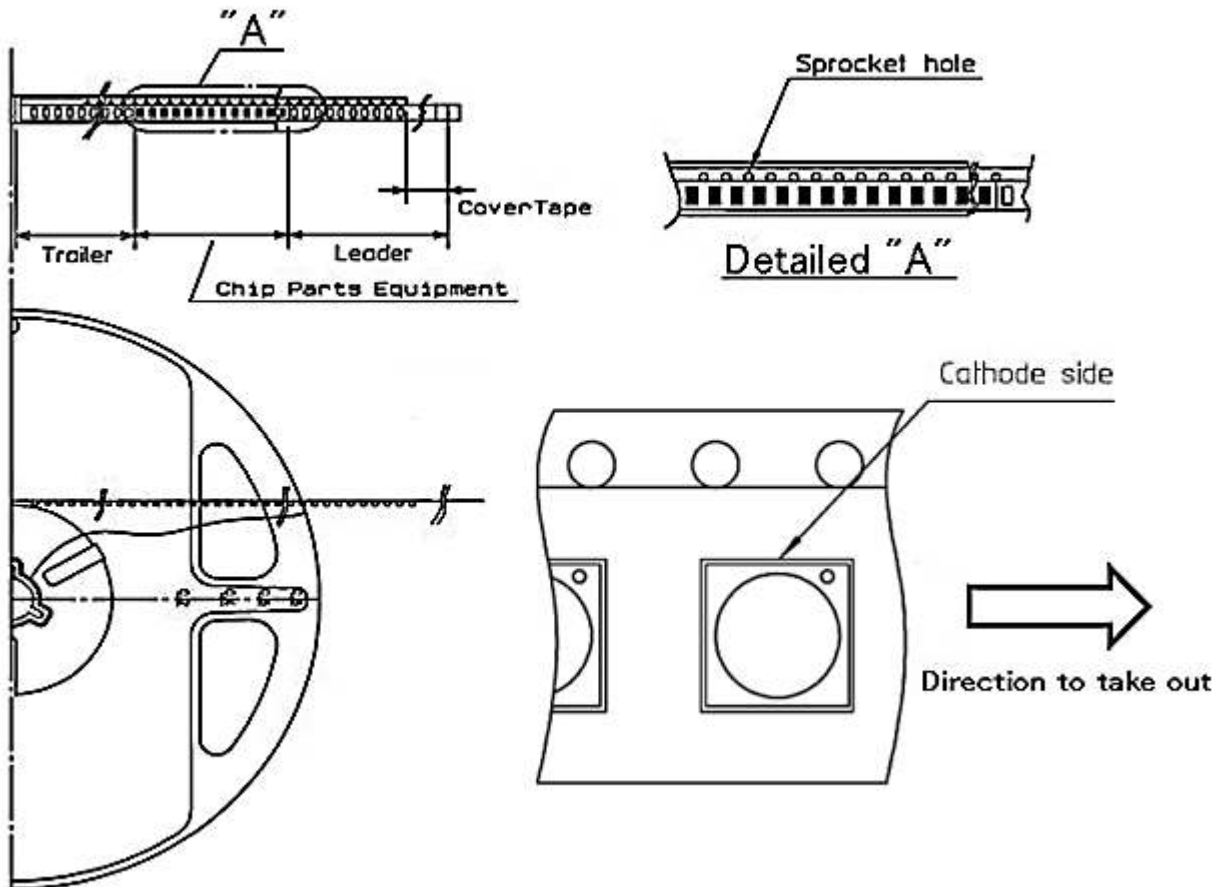

Note

"-TR" means Cathode Side of LEDs should be placed on the sprocket-hole side.

Items		Specifications	Remarks
Leader area	Cover-tape	Cover-tape shall be longer than 320mm without carrier-tape	The end of cover-tape shall be held with adhesive tape.
	Carrier-tape	Empty pocket shall be more than 13(100mm) pieces.	Please refer to the above figure for Taping & reel orientation .
Trailer area		Empty pocket shall be more than 20(160mm) 15 pieces.	The end of taping shall be inserted into a slit of the hub.

Taping and Reel Specifications

GSPW1641NSE-50X-TR

(acc.to JIS-C0806-03)

【Qty. per Reel】

2,000parts/reel

Minimum Qty. per reel might be 500 parts when getting less than 2,000 parts. In such case, parts of 500-unit-qty. shall be packed in a reel and the qty. shall be identified on the label.

【Mechanical strength】

Cover-tape adhesive strength shall be 0.1~1.3N (An angle between carrier-tape and cover-tape shall be170 deg.). Both tapes shall be so sealed that the contained parts will not come out from the tape when it is bent at a radius of 15mm.

【Others】

Reversed-orientation, Up-side down placing, side placing and out of spec. parts mix shall not be held. Max qty. of empty pocket per reel shall be defined as follows.

Max, qty. of empty pocket per reel shall be defined as follows.

Qty./Reel	Max.Qty. of empty pocket	Remarks
500	1	-
1,000	1	-
1,500	1	-
2,000	2	No continuance

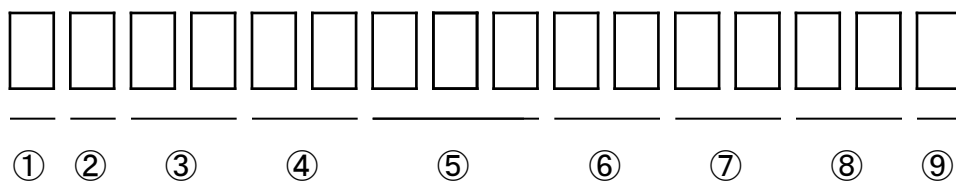

① - 1digit : Production Location (Mark identify alphabet)

② - 1digit : Production Year (Last digit of Production Year 2009→9,2010→0,2011→1,···)

③ - 2digits : Production Month (Jan. to Sep. should be 01,02,03,·····)

④ - 2digits : Production Date

⑤ - 3digits : Serial Number

⑥ - 2digits : Tape and Reel following Number

⑦ - 2digits : Luminous Intensity Rank.

(If luminous intensity rank is 1 digit, "-" shall be dashed on the place for the second digit.

If there is no identified intensity rank, "- -" is used to indicate.)

- ⑧ - 2digits : Chromaticity Rank
 (If chromaticity rank is 1 digit, "-" shall be dashed on the place for the second digit.
 If there is no identified intensity rank, "-" is used to indicate.)

Chromaticity Rank

Rank Code	Chromaticity Rank
2A	30A
2B	30B
2C	30C
2D	30D
2G	30G

- ⑧ - 1digits VF Rank
 (If there is no identified VF rank, "-" is used to indicate.)

- ⑨ - 1digit : Option Rank (Stanley normally print "-" to indicate)

This product is in compliance with RoHS•ELV.

Prohibition substance and its criteria value of RoHS•ELV are as follows.

- RoHS instruction Refer to following (1)~(6).
- ELV instruction Refer to following (1)~(4).

	Substance Group Name	Criteria Value
(1)	Lead and its compounds	1,000ppm Max
(2)	Cadmium and its compounds	100ppm Max
(3)	Mercury and its compounds	1,000ppm Max
(4)	Hexavalent chromium	1,000ppm Max
(5)	PBB	1,000ppm Max
(6)	PBDE	1,000ppm Max

1. Reliability Testing Result

Test Item	Standard	Test Condition	Duration	Failure
Room Temperature Operating Life	EIAJ ED-4701 /100(101)	Ta=25°C I _F =600mA	1,000h	0 / 20
High Temperature Operating Life	EIAJ ED-4701 /100(101)	Ta=85°C I _F =600mA	1,000h	0 / 20
Low Temperature Operating Life	EIAJ ED-4701 /100(101)	Ta=-40°C I _F =600mA	1,000h	0 / 20
Wet High Temperature Operating Life	EIAJ ED-4701 /100(102)	Ta=60°C 90% I _F =600mA	1,000h	0 / 20
High Temperature Storage Life	EIAJ ED-4701 /200(201)	Ta=100°C	1,000h	0 / 20
Low Temperature Storage Life	EIAJ ED-4701 /200(202)	Ta= -30°C	1,000h	0 / 20
Thermal Shock	EIAJ ED-4701 /100(105)	Ta= -30°C ~100°C (each 15min)	1,000 cycles	0 / 20
Resistance to Reflow Soldering	EIAJ ED-4701 /300(301)	Moisture Soak : 30°C 70% 168h Preheating : 150~180°C 120sec MAX. Soldering : 260°C Peak	Twice	0 / 20
Electrostatic Discharge (ESD) ※1	EIAJ ED-4701 /300(304)	C=100pF R2=1.5kΩ ±2,000V	Once of each polarity	0 / 20

※1 Reference test

2. Failure Criteria

Item	Symbol	Conditions	Failure Criteria
Luminous Intensity	I _V	I _F =100mA	Testing Min. Value < Standard Min. Value × 0.5
Forward Voltage	V _F	I _F =100mA	Testing Max. Value ≥ Standard Max. Value × 1.2
Cosmetic appearance	-	-	Occurrence of notable decoloration, deformation and cracking

Special Notice to Customers Using the Products and Technical Information Shown in This Data Sheet

- 1) The technical information shown in the data sheets are limited to the typical characteristics and circuit examples of the referenced products. It does not constitute the warranting of industrial property nor the granting of any license.
- 2) For the purpose of product improvement, the specifications, characteristics and technical data described in the data sheets are subject to change without prior notice. Therefore it is recommended that the most updated specifications be used in your design.
- 3) When using the products described in the data sheets, please adhere to the maximum ratings for operating voltage, heat dissipation characteristics, and other precautions for use. We are not responsible for any damage which may occur if these specifications are exceeded.
- 4) The products that have been described to this catalog are manufactured so that they will be used for the electrical instrument of the benchmark (OA equipment, telecommunications equipment, AV machine, home appliance and measuring instrument).
The application of aircrafts, space borne application, transportation equipment, medical equipment and nuclear power control equipment, etc. needs a high reliability and safety, and the breakdown and the wrong operation might influence the life or the human body. Please consult us beforehand if you plan to use our product for the usages of aircrafts, space borne application, transportation equipment, medical equipment and nuclear power control equipment, etc. except OA equipment, telecommunications equipment, AV machine, home appliance and measuring instrument.
- 5) In order to export the products or technologies described in this data sheet which are under the "Foreign Exchange and Foreign Trade Control Law," it is necessary to first obtain an export permit from the Japanese government.
- 6) No part of this data sheet may be reprinted or reproduced without prior written permission from Stanley Electric Co., Ltd.
- 7) The most updated edition of this data sheet can be obtained from the address below:
<http://www.stanley-components.com/en/>