

## DESCRIPTION

The EV7745DF-01A is the evaluation board for the MP7745, a stereo 20W Class D Audio Amplifier. It is one of MPS' products of fully integrated audio amplifiers which dramatically reduce solution size by integrating the following:

- 250mΩ power MOSFETs
- Startup / Shutdown pop elimination
- Short circuit protection circuits

The MP7745 utilizes a single ended output structure capable of delivering 2x20W into 4Ω speakers. MPS Class D Audio Amplifiers exhibit the high fidelity of a Class A/B amplifier at high efficiency. The circuit is based on the MPS' AAM™ proprietary variable frequency topology that delivers excellent linearity, fast response time and operates on a single power supply.

## ELECTRICAL SPECIFICATIONS

Parameter	Symbol	Value	Units
Supply Voltage	$V_{DD}$	24	V

## FEATURES

- 2 x 20W Output at  $V_{DD} = 24V$  into a 4Ω load
- THD+N = 0.05% at 1W, 8Ω, 1kHz
- 93% Efficiency at 19W and  $V_{DD}=24V$  with 4Ω load
- Low Noise (103μV Typical)
- 9.5V to 26V Operation from a Single Supply

## APPLICATIONS

- Flat Panel TV
- Portable Docking Stations
- Surround Sound DVD Systems
- Televisions
- Multimedia Computers
- Home Stereo Systems

"MPS" and "The Future of Analog IC Technology" are Registered Trademarks of Monolithic Power Systems, Inc.

AAM (Analog Adaptive Modulation) is a Trademark of Monolithic Power Systems, Inc.

## EV7745DF-01A EVALUATION BOARD



(L x W x H) 3.5" x 2.5" x 1.2"  
9.0cm x 6.3cm x 3.0cm

Board Number	MPS IC Number
EV7745DF-01A	MP7745DF

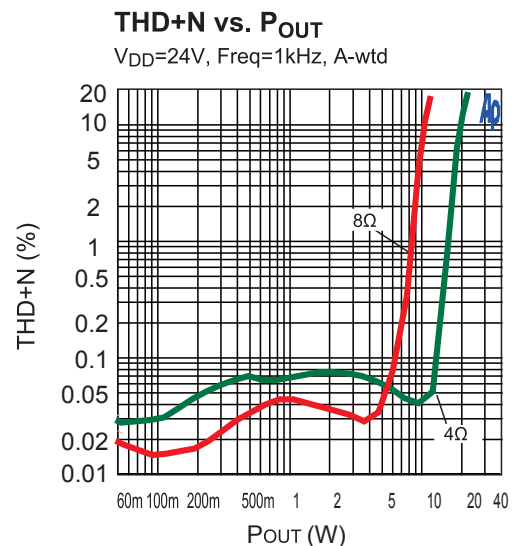

**EVALUATION BOARD SCHEMATIC**

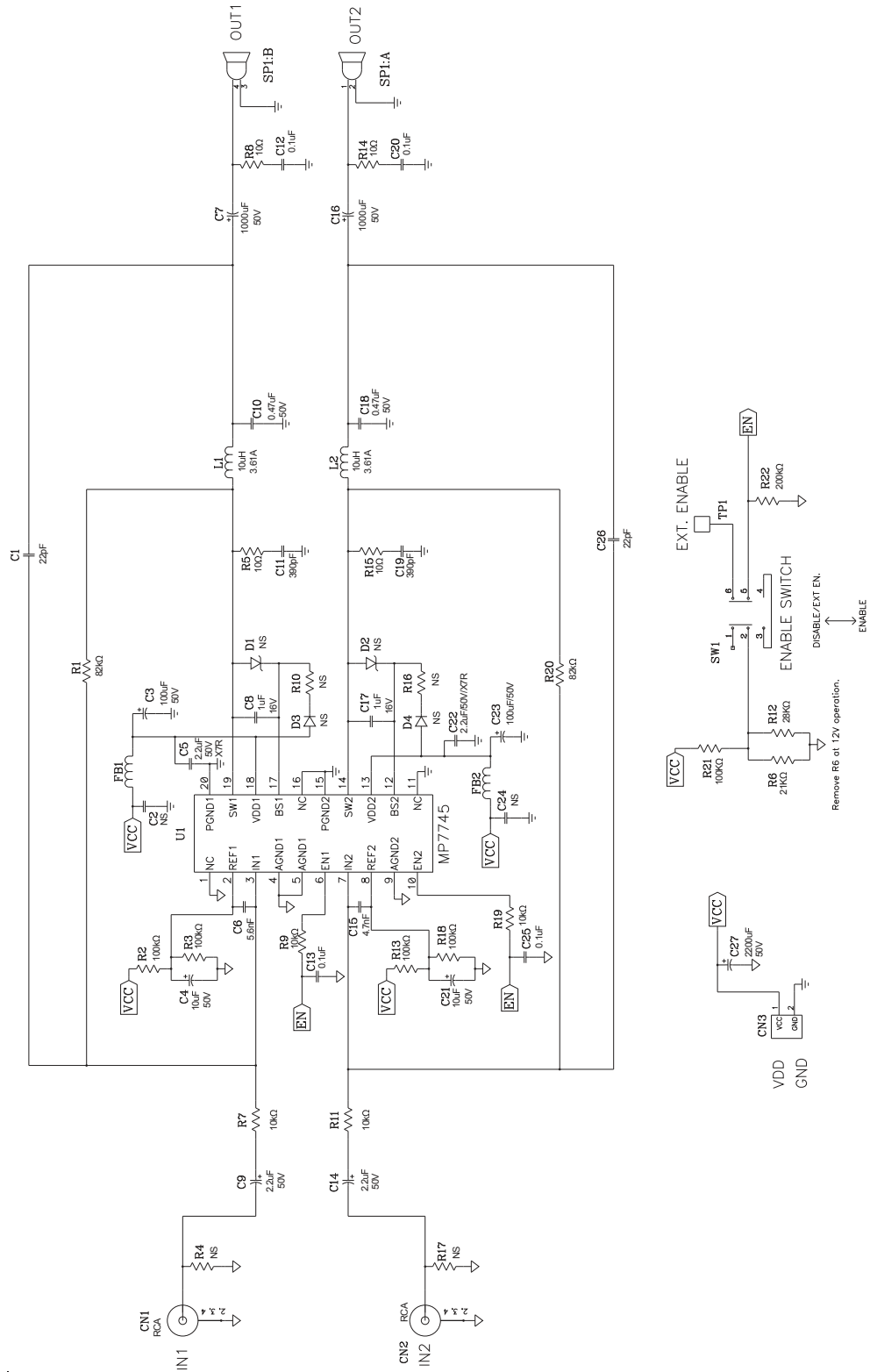

**EV7745DF-01A BILL OF MATERIALS**

Qty	Ref	Value	Description	Package	Manufacturer	Manufacturer P/N
2	C1, C26	22pF	Ceramic Capacitor,50V,C0G	0603	muRata	GRM1885C1H220JA01D
2	C2, C24	NS				
2	C3, C23	100uF	Electrolytic Cap., 50V	Radial	Rubycon	
2	C4, C21	10uF	Electrolytic Cap., 50V	Radial	Rubycon	
2	C5, C22	2.2uF	Ceramic Capacitor,50V,X7R	1206	muRata	GRM31CR71H225KA88L
1	C6	5.6nF	Ceramic Capacitor, 50V,X7R	0603	muRata	GRM188R71H562KA01
2	C7,C16	1000uF	Electrolytic Cap., 50V	Radial	Rubycon	
2	C8,C17	1uF	Ceramic Capacitor,16V,X7R	0603	muRata	GRM188R71C105KA1
2	C9,C14	2.2uF	Electrolytic Cap., 50V	Radial	Rubycon	
2	C10,C18	0.47uF	FILM,50V	Radial	any	
2	C11, C19	390pF	Ceramic Capacitor,50V,C0G	0603	muRata	GRM1885C1H3901JA01D
2	C12,C20	0.1uF	Ceramic Capacitor, 50V,X7R	0805	muRata	GRM21BR71H104KA01L
2	C13,C25	0.1uF	Ceramic Capacitor, 50V,X7R	0603	muRata	GRM188R71H104KA93D
1	C15	4.7nF	Ceramic Capacitor, 50V,X7R	0603	muRata	GRM188R71H472KA01D
1	C27	2200uF	Electrolytic Cap, 50V	Radial	Rubycon	
2	R1,R20	82.5KΩ	Film Res., 1%	0603	Yageo	RC0603FR-0782K5L
5	R2,R3, R13, R18, R21	100KΩ	Film Res., 1%	0603	Yageo	RC0603FR-07100KL
4	R4,R17, R10,R16	NS				
2	R5,R15	10Ω	Film Res., 5%	0603		0603SAJ0100T5E
1	R6	21KΩ	Film Res., 1%	0603	Yageo	RC0603FR-0721KL
2	R8,R14	10Ω	Film Res., 5%	0805		CR05T05NJ10R
4	R7,R9, R11,R19	10KΩ	Film Res., 1%	0603	Yageo	RC0603FR-0710KL
1	R12	28KΩ	Film Res., 1%	0603	Yageo	RC0603FR-0728KL
1	R22	200KΩ	Film Res., 5%	0603	Yageo	RC0603JR-07200KL
2	D2,D1, D3,D4	NS				
2	FB1, FB2		Ferrite Bead, 6A	1206	LION	PB321611-320

**EV7745DF-01A BILL OF MATERIALS** *(continued)*

Qty	Ref	Value	Description	Package	Manufacturer	Manufacturer P/N
2	L1, L2	10uH	Inductor, 3.61A	Radial	Toko	10RHBP-#A671HN-100L
1	U1		Class D Audio Amplifier	TSSOP20F	MPS	MP7745DF
1	SW1		Switch slide DPDT 12V .1A L=4			
1	CN3		Banana Jack Connector			
2	CN1, CN2		Phono Jack, Female			
1	TP1		Test point PC MINI .040"D			
1	SP1		Speaker Connector			

**PRINTED CIRCUIT BOARD LAYOUT**

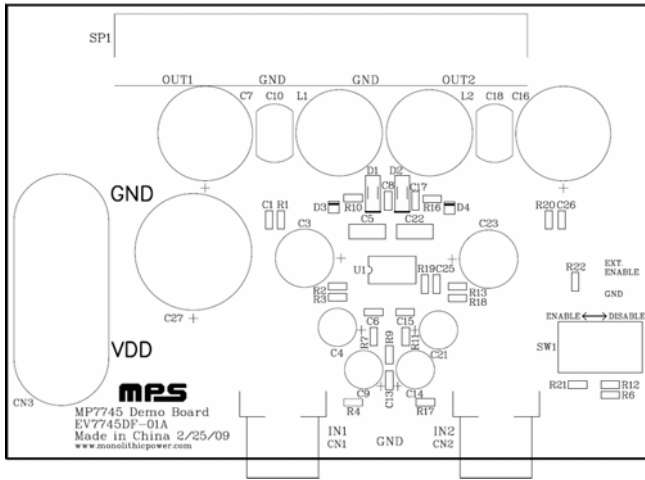

**Figure 1—Top Silk Layer**

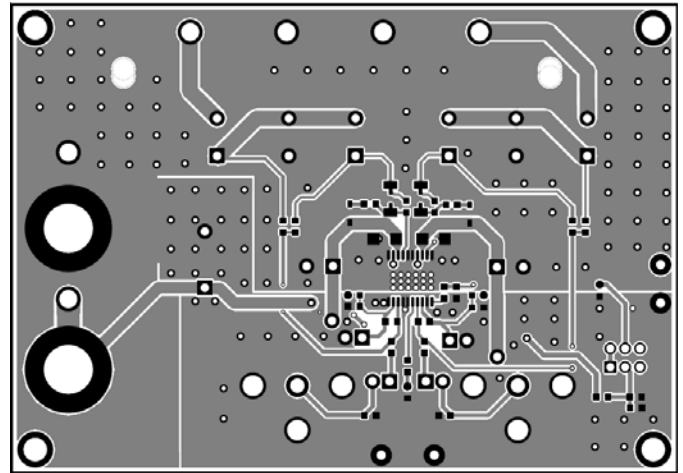

**Figure 2—Top Layer**

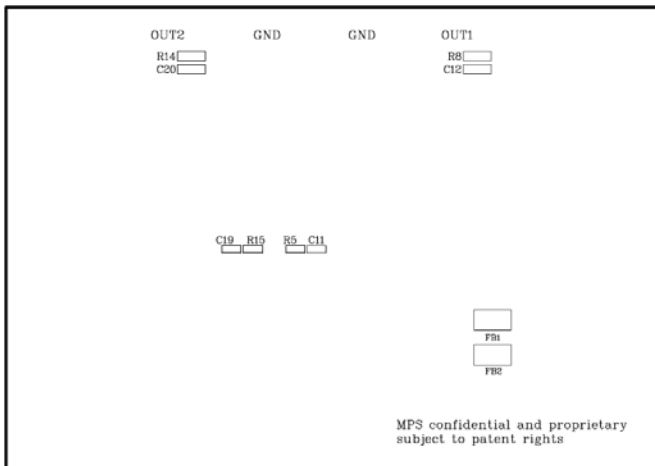

**Figure 3—Bottom Silk Layer**

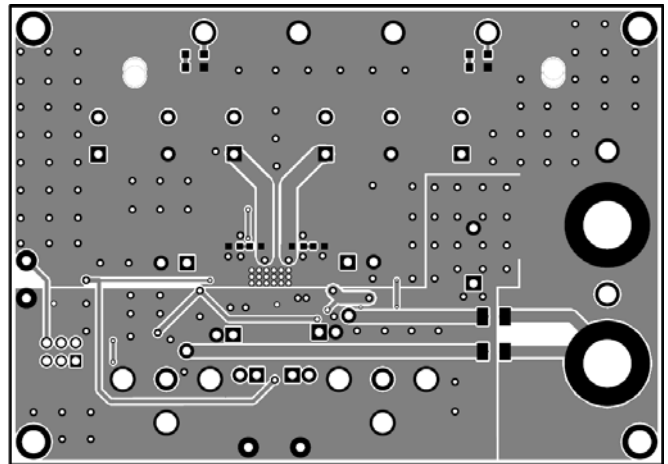

**Figure 4—Bottom Layer**

## QUICK START GUIDE

This board set up from the factory for 24V operation. To use with a 12V power supply, adjust the components as specified in the 12V Operation Modifications section below. For more information, consult the MP7745 datasheet.

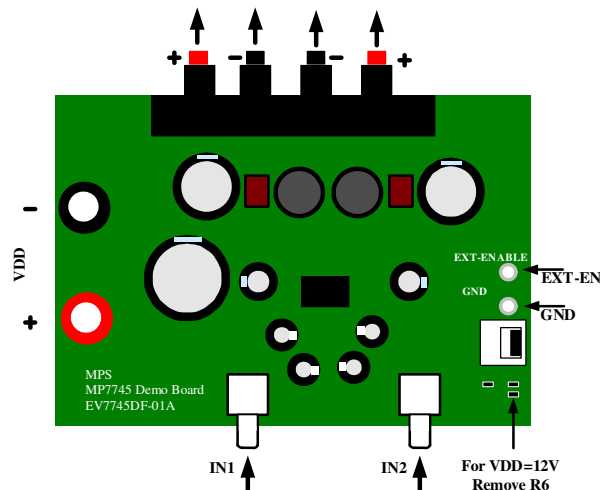

**Figure 5—EV7745DF-01A Connection Diagram**

1. Power Requirements
  - a. Power supply: 9.5V to 26V, 3.5A maximum.
  - b. 0V to 1.3V<sub>RMS</sub> (max) audio signal source.
  - c. Speaker: 4Ω to 8Ω.
2. Setup Condition for 24V Operation
  - a. Adjust the power supply to 24V (do not turn on).
  - b. Connect the outputs to the external speakers.
  - c. Connect the power supply to the V<sub>DD</sub> terminals.
  - d. Set the enable switch to the DISABLE position.
  - e. Connect the audio input signal source to the amplifier inputs (IN1, IN2).
  - f. Turn on the power supply to apply power to the board.
3. 12V Operation Modifications
  - a. Change C6 to 3.3nF and C15 to 2.2nF components.
  - b. Remove R6 from the demo board.
  - c. Adjust the power supply to 12V (do not turn on).
  - d. Do as step b~f specified in Section 2.
4. Music Turn-On Sequence
  - a. Set the enable switch to the ENABLE position.
5. Music Turn-Off Sequence
  - a. Set the enable switch to the DISABLE position.
  - b. Turn off power supply.

**NOTICE:** The information in this document is subject to change without notice. Please contact MPS for current specifications. Users should warrant and guarantee that third party Intellectual Property rights are not infringed upon when integrating MPS products into any application. MPS will not assume any legal responsibility for any said applications.