

1V Synchronous Boost Converter

FEATURES

- 1V Input Voltage Operation Startup Guaranteed Under Full Load on Main Output With Operation Down to 0.4V
- Input Voltage Range of 1V to $V_{OUT} + 0.5V$
- 500mW Output Power at Battery Voltages as Low as 0.8V
- Secondary 9V Supply From a Single Inductor
- Adjustable Output Power Limit Control
- Output Fully Disconnected in Shutdown
- Adaptive Current Mode Control for Optimum Efficiency
- 8 μ A Shutdown Supply Current

DESCRIPTION

The UCC3941 family of low input voltage single inductor boost converters are optimized to operate from a single or dual alkaline cell, and step up to a 3.3V, 5V, or an adjustable output at 500mW. The UCC3941 family also provides an auxiliary 9V 100mW output, primarily for the gate drive supply, which can be used for applications requiring an auxiliary output such as a 5V supply by linear regulating. The primary output will start up under full load at input voltages typically as low as 0.8V, with a guaranteed maximum of 1V, and will operate down to 0.4V once the converter is operating, maximizing battery utilization.

Demanding applications such as Pagers and PDA's require high efficiency from several milli-watts to several hundred milli-watts, and the UCC3941 family accommodates these applications with >80% typical efficiencies over the wide range of operation. The high efficiency at low output current is achieved by optimizing switching and conduction losses along with low quiescent current. At higher output current the 0.25 Ω switch, and 0.4 Ω synchronous rectifier, along with continuous mode conduction, provide high efficiency. The wide input voltage range on the UCC3941 family can accommodate other power sources such as NiCd and NiMH.

Other features include maximum power control and shutdown control. Packages available are the 8-pin SOIC (D) and 8-pin DIP (N or J).

SIMPLIFIED BLOCK DIAGRAM AND APPLICATION CIRCUIT

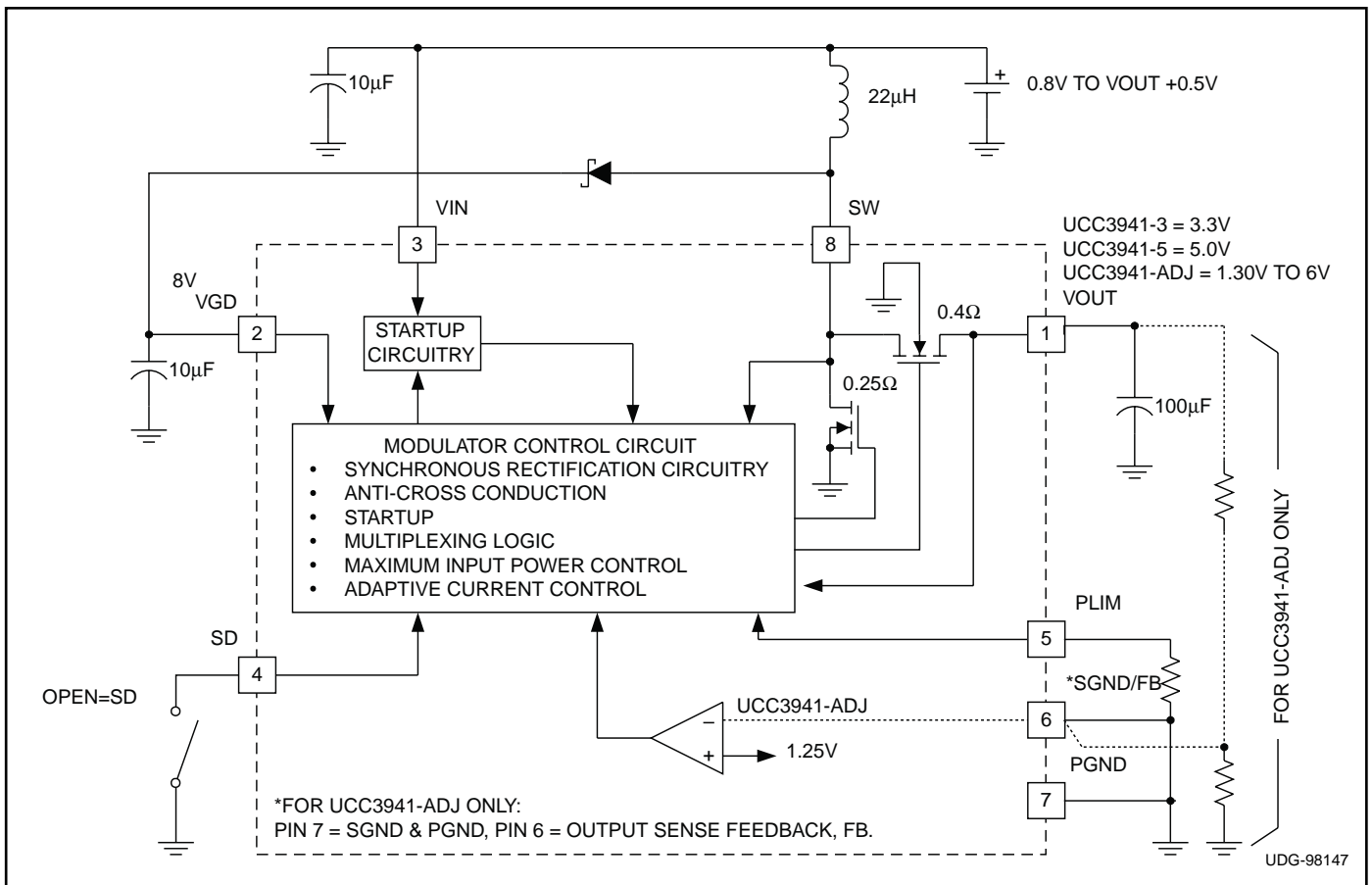

CONNECTION DIAGRAM

ABSOLUTE MAXIMUM RATINGS

VIN Voltage	−0.3V to 10V
SD Voltage	−0.3V to VIN
PLIM Voltage	−0.3V to 10V
VGD Voltage	−0.3V to 15V
SW Voltage	−0.3V to 15V
VOUT Voltage	−0.3V to 10V
Storage Temperature	−65°C to +150°C
Junction Temperature	−55°C to +150°C
Lead Temperature (Soldering, 10 sec.)	+300°C

Currents are positive into, negative out of the specified terminal. Consult Packaging Section of Databook for thermal limitations and considerations of packages.

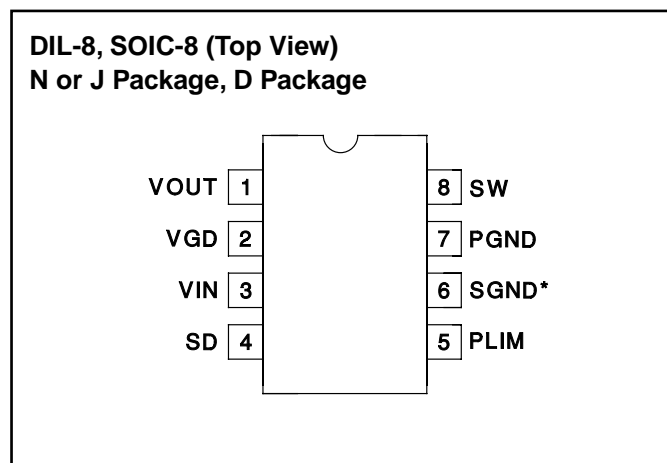

Pin 6 is FB for UCC3941-ADJ.

ELECTRICAL CHARACTERISTICS: Unless otherwise specified, for UCC3941, $T_A = 0^\circ\text{C}$ to 70°C ; for UCC2941, $T_A = -40^\circ\text{C}$ to 85°C ; $V_{IN} = 1.25\text{V}$, $T_A = T_J$.

PARAMETER	TEST CONDITIONS	MIN	TYP	MAX	UNITS
VIN Section					
Minimum Startup Voltage	No External VGD Load, $T_J = 25^\circ\text{C}$, $I_{OUT} = 100\text{mA}$ (Note 1)		0.8	1.0	V
Minimum Start Voltage	No External VGD Load, $I_{OUT} = 100\text{mA}$, $T_J = 0^\circ\text{C}$ to 85°C (Note 1)		0.9	1.1	V
Minimum Startup Voltage	No External VGD Load, $T_J = -40^\circ\text{C}$ to 0°C		0.9	1.5	V
Minimum Dropout Voltage	No External VGD Load, $I_{OUT} = 100\text{mA}$, $V_{GD} = 6.3\text{V}$ (Note 1)			0.5	V
Input Voltage Range		1		$V_{OUT} + 0.5$	V
Quiescent Supply Current	(Note 2)		13	25	μA
Supply Current at Shutdown	SD = Open		8	20	μA
Output Section					
Quiescent Supply Current	(Note 2)		32	80	μA
Supply Current at Shutdown	SD = Open		6	15	μA
Regulation Voltage (UCC3941-3)	$1\text{V} < V_{IN} < 3\text{V}$	3.18	3.25	3.37	V
	$1\text{V} < V_{IN} < 3\text{V}$, $0\text{mA} < I_{OUT} < 150\text{mA}$ (Note 1)	3.17	3.30	3.43	V
Regulation Voltage (UCC3941-5)	$1\text{V} < V_{IN} < 5\text{V}$	4.85	5.00	5.15	V
	$1\text{V} < V_{IN} < 5\text{V}$, $0\text{mA} < I_{OUT} < 100\text{mA}$ (Note 1)	4.8	5.0	5.2	V
FB Voltage (UCC3941-ADJ)	$1\text{V} < V_{IN} < 3\text{V}$	1.212	1.250	1.288	V
VGD Output Section					
Quiescent Supply Current	(Note 2)		25	60	μA
Supply Current at Shutdown	SD = Open		8	20	μA
Regulation Voltage	$1\text{V} < V_{IN} < 3\text{V}$	7.5	8.7	9.2	V
	$1\text{V} < V_{IN} < 3\text{V}$, $0\text{mA} < I_{OUT} < 10\text{mA}$ (Note 1)	7.4	8.7	9.3	V
Inductor Charging Section (L = 22μH)					
Peak Discontinuous Current	Over Operating Range		0.50	0.85	A
Peak Continuous Current	$R_{PLIM} = 6.2\Omega$, UCC3941-3 and UCC3941-5	0.5	0.8	1.1	A
	UCC3941-ADJ	0.6	0.9	1.3	A

ELECTRICAL CHARACTERISTICS: Unless otherwise specified, for UCC3941, $T_A = 0^\circ\text{C}$ to 70°C ; for UCC2941, $T_A = -40^\circ\text{C}$ to 85°C ; $V_{IN} = 1.25\text{V}$, $T_A = T_J$.

PARAMETER	TEST CONDITIONS	MIN	TYP	MAX	UNITS
Inductor Charging Section					
Charge Switch $R_{DS(on)}$	N and D Package, $I = 200\text{mA}$		0.25	0.4	Ω
Current Limit Delay	(Note 1)		50		ns
Synchronous Rectifier Section					
Rectifier $R_{DS(on)}$	N and D Package, $I = 200\text{mA}$, UCC3941-ADJ $V_{OUT} = 3.3\text{V}$ and UCC3941-3		0.35	0.6	Ω
	N and D Package, $I = 200\text{mA}$, UCC3941-5		0.5	0.8	Ω
Shutdown Section					
Shutdown Bias Current		-10	-7		μA

Note 1: Performance from application circuit shown in Figures 3 - 5 guaranteed by design and alternate testing methods, but not 100% tested as shown in production.

Note 2: For the UCC3941-3, $V_{OUT} = 3.47\text{V}$ and $V_{GD} = 9.3\text{V}$. For the UCC3941-5, $V_{OUT} = 5.25\text{V}$, $V_{GD} = 9.3\text{V}$. For the UCC3941-ADJ, $FB = 1.315\text{V}$, $V_{GD} = 9.3\text{V}$.

PIN DESCRIPTIONS

FB: Feedback control pin used in the UCC3941-ADJ version only. The internal reference for this comparator is 1.25V and external resistors provide the gain to the output voltage.

PGND: Power ground of the IC. The inductor charging current flows through this pin. For the UCC3941-ADJ signal ground and power ground lines are tied to a common pin.

PLIM: This pin is programmed to set the maximum input power for the converter. For example a 1A current limit at 1V would have a 333mA limit at 3V input keeping the input power constant at 1W. The peak current at $V_{IN} = 1\text{V}$ is programmed to 1.5A (1.5W) when this pin is grounded. The power limit is given by:

$$P_{L(W)} = \frac{11.8 \cdot n}{R_{PL} + 6.7} + V_{IN}(0.26)$$

where R_{PL} is equal to the external resistor from the PLIM pin to ground and n is the expected efficiency of the converter. The peak current limit is given by:

$$I_{PK(A)} = \frac{11.8 \cdot n}{V_{IN} \cdot (R_{PL} + 6.7)} + 0.26$$

Constant power gives several advantages over constant current such as lower output ripple.

SD: When this pin is open, the built in $7\mu\text{A}$ current source pulls up on the pin and programs the IC to go into shutdown mode. This pin requires an open circuit for shutdown and will not operate correctly when driven to a logic level high with TTL or CMOS logic. When this pin is connected to ground, (either directly or with a transistor) the IC is enabled and both output voltages will regulate.

SGND: Signal ground of the IC. For the UCC3941-ADJ signal ground and power ground lines are tied to a common pin.

SW: An inductor is connected between this node and V_{IN} . The V_{GD} (Gate Drive Supply) flyback diode is also connected to this pin. When servicing the 3.3V supply, this pin will go low charging the inductor, then shut off, dumping the energy through the synchronous rectifier to the output. When servicing the V_{GD} supply, the internal synchronous rectifier stays off, and the energy is diverted to V_{GD} through the flyback diode. During discontinuous portions of the inductor current a MOSFET resistively connects V_{IN} to SW damping excess circulating energy to eliminate undesired high frequency ringing.

VGD: The V_{GD} pin which is coarsely regulated around 9V and is primarily used for the gate drive supply for the power switches in the IC. This pin can be loaded with up to 10mA as long as it does not present a load at voltages below 2V. This ensures proper startup of the IC. The V_{GD} supply can go as low as 7.5V without interfering with the servicing of the 3.3V output. Below 7.5V, V_{GD} will have the highest priority, although practically the voltage should not decay to that level if the output capacitor is sized properly.

VIN: Input voltage to supply the IC during startup. After the output is running the IC draws power from V_{OUT} or V_{GD} .

VOUT: Main output voltage (3.3V, 5V or adjustable) which has highest priority in the multiplexing scheme, as long as V_{GD} is above the critical level of 7.5V. Loads over 150mA are achievable at 1V input voltage. This output will startup with 1V input at full load.

APPLICATION INFORMATION

A detailed block diagram of the UCC3941 is shown in Fig. 1. Unique control circuitry provides high efficiency power conversion for both light and heavy loads by transitioning between discontinuous and continuous conduction based on load conditions. Fig. 2 depicts converter

waveforms for the application circuit shown in Fig. 3. A single 22μH inductor provides the energy pulses required for a highly efficient 3.3V converter at up to 500mW output power.

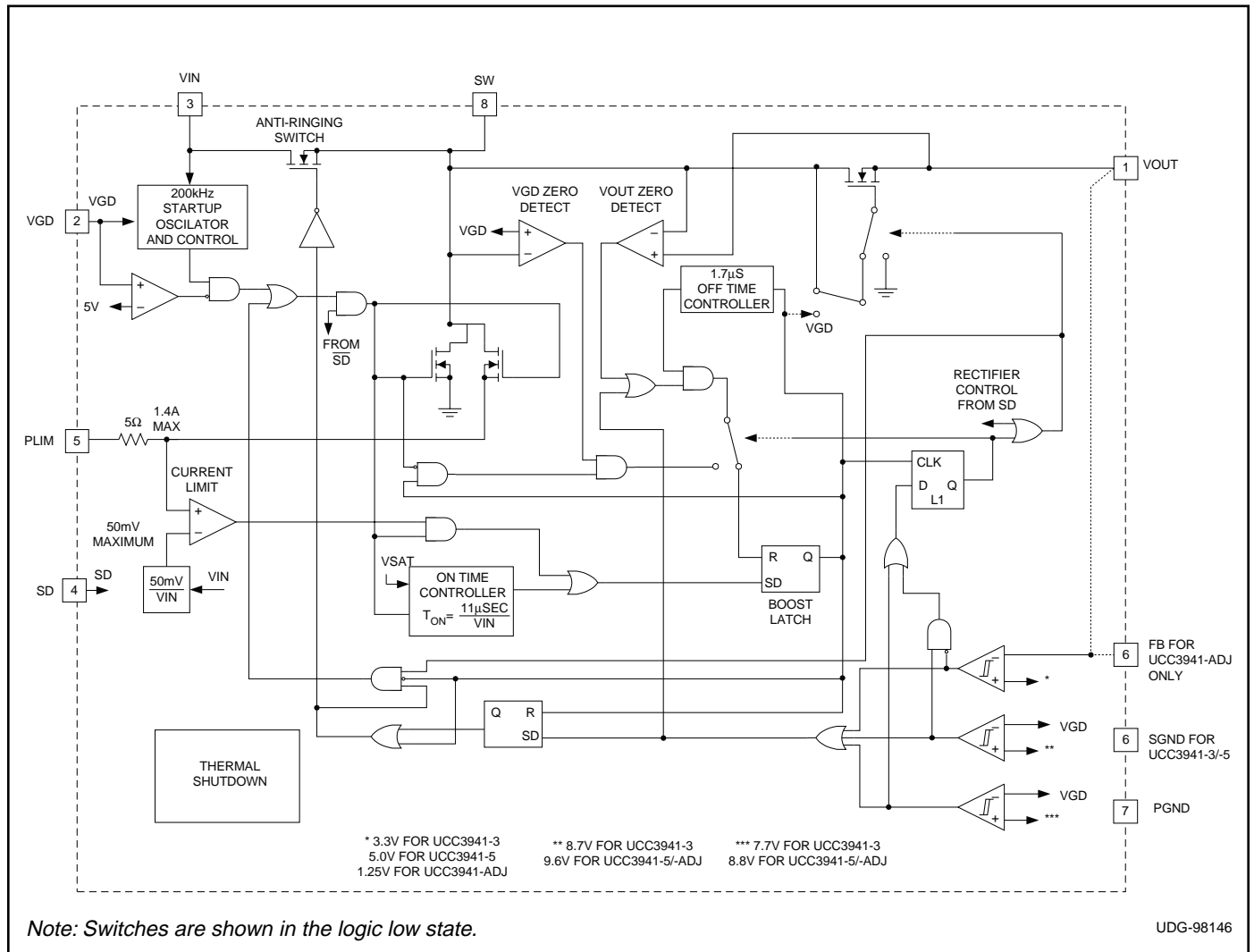

Figure 1. 1V Synchronous boost.

APPLICATION INFORMATION (cont.)

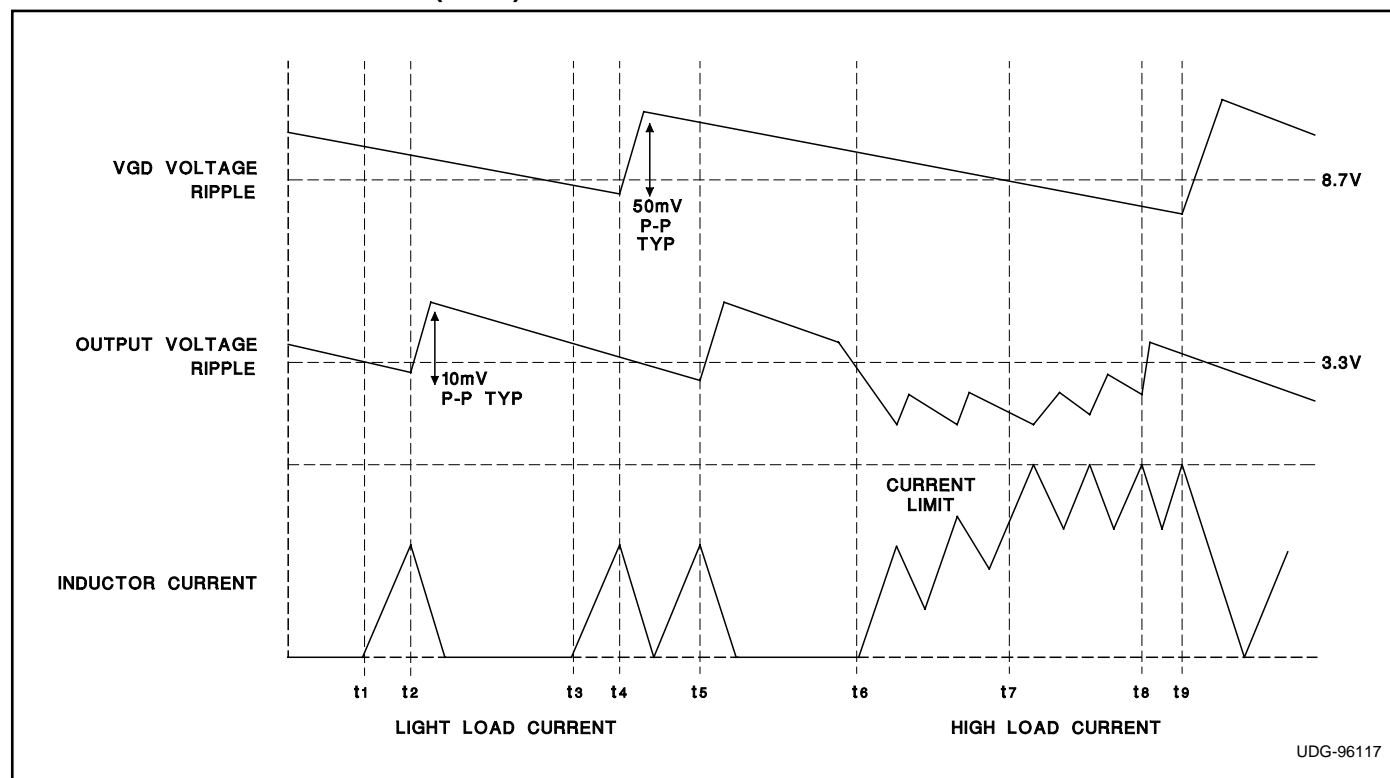

Figure 2. Inductor current and output ripple waveforms.

At time t_1 , the 3.3V output drops below its lower threshold, and the inductor is charged with an on time determined by:

$$T_{ON} = \frac{12 \mu s}{V_{IN}}$$

For a 1.25V input, and a 22 μ H inductor, the resulting peak current is approximately 500mA. At time t_2 , the inductor begins to discharge with a minimum off time of 1.7 μ s. Under lightly loaded conditions, the amount of energy delivered in this single pulse would satisfy the voltage control loop, and the converter would not command any more energy pulses until the output again drops below the lower voltage threshold.

At time t_3 , the VGD supply has dropped below its lower threshold, but the output voltage is still above its threshold point. This results in an energy pulse to the gate drive supply at t_4 . However, while the gate drive is being serviced, the output voltage has dropped below its lower threshold, so the state machine commands an energy pulse to the output as soon as the gate drive pulse is completed.

Time t_6 , represents a transition between light and heavy load. A single energy pulse is not sufficient to force the output voltage above its upper threshold before the minimum off time has expired, and a second charge cycle is commanded. Since the inductor current does not reach zero in this case, the peak current is greater than 0.5A at the end of the next charge on time. The result is a ratcheting of inductor current until either the output voltage is satisfied, or the converter reaches its programmed current limit. At time t_7 , the gate drive voltage has dropped below its threshold but the converter continues to service the output because it has highest priority, unless VGD drops below 7.5V.

Between t_7 and t_8 , the converter reaches its peak current limit which is determined by R_{PL} and V_{IN} . Once the limit is reached, the converter operates in continuous mode with approximately 200mA of ripple current. At time t_8 , the output voltage is satisfied, and the converter can service VGD, which occurs at t_9 .

APPLICATION INFORMATION (cont.)

1.0V input.

Inductor Section

An inductor value of 22μH will work well in most applications, but values between 10μH and 100μH are also acceptable. Lower value inductors typically offer lower ESR and smaller physical size. Due to the nature of the “bang-bang” controllers, larger inductor values will typically result in larger overall voltage ripple, because once the output voltage level is satisfied the converter goes discontinuous, resulting in the residual energy of inductor causing overshoot.

It is recommended to keep the ESR of the inductor below 0.15Ω for 500mW applications. A Coilcraft DT3316P-223 surface mount inductor is one choice since it has a current rating of 1.5A and an ESR of 84mΩ Other choices

Table 1. Inductor Suppliers

MANUFACTURER	PART NUMBERS
Coilcraft Cary, Illinois Tel: 708-639-2361 Fax: 708-639-1469	DT Series
Coiltronics Boca Raton, Florida Tel: 407-241-7876	CTX Series

for surface mount inductors are shown in Table 1.

Output Capacitor Selection

Once the inductor value is selected the capacitor value will determine the ripple of the converter. The worst case peak to peak ripple of a cycle is determined by two components, one is due to the charge storage characteristic, and the other is the ESR of the capacitor. The worst case ripple occurs when the inductor is operating at maximum current and is expressed as follows:

$$\Delta V = \frac{(I_{CL})^2 \cdot L}{2 \cdot C \cdot (V_O - V_I)} + I_{CL} \cdot C_{ESR} \text{ where}$$

$$I_{CL} = \text{the peak inductor current} \left(I_{CL} = \frac{\text{Power Limit}}{V_{IN}} \right)$$

- ΔV = output ripple
- V_O = output voltage
- V_I = input voltage
- C_{ESR} = ESR of the output capacitor

A Sanyo OS-CON series surface mount capacitor (10SN100M) is one recommendation. This part has an ESR rating of 90mΩ at 100μF. Other potential capacitor sources are shown in Table 2.

Table 2. Capacitor Suppliers

MANUFACTURER	PART NUMBER
Sanyo Video Components San Diego, California Tel: 619-661-6322 Fax: 619-661-1055	OS-CON Series
AVX Sanford, Maine Tel: 207-282-5111 Fax: 207-283-1941	TPS Series
Sprague Concord, New Hampshire Tel: 603-224-1961	695D Series

Input Capacitor Selection

Since the UCC3941 family does not require a large decoupling capacitor on the input voltage to operate properly, a 10μF capacitor is sufficient for most applications. Optimum efficiency will occur when the capacitor value is large enough to decouple the source impedance. This usually occurs for capacitor values in excess of 100μF.

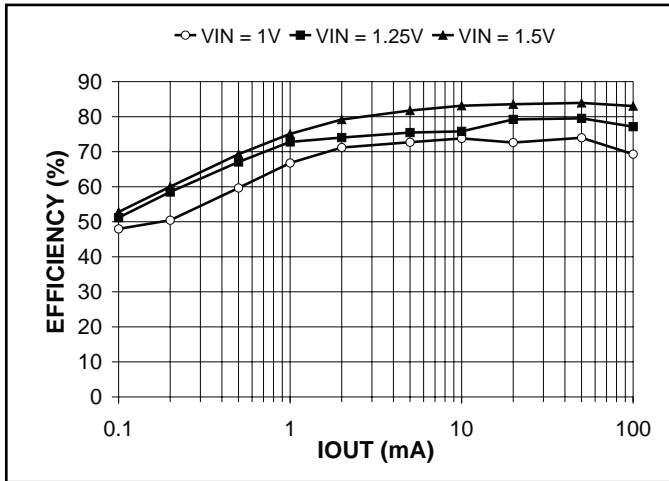

Figure 6. UCC3941 Efficiency vs. I_{OUT} , $V_{OUT} = 3.3V$.

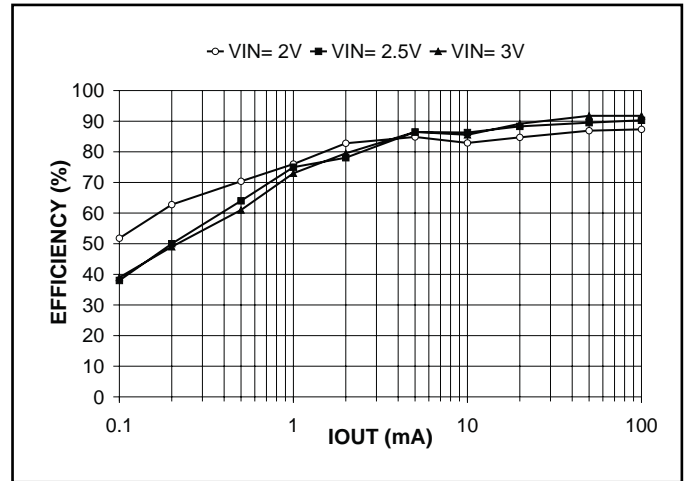

Figure 7. UCC3941 Efficiency vs. I_{OUT} , $V_{OUT} = 3.3V$.

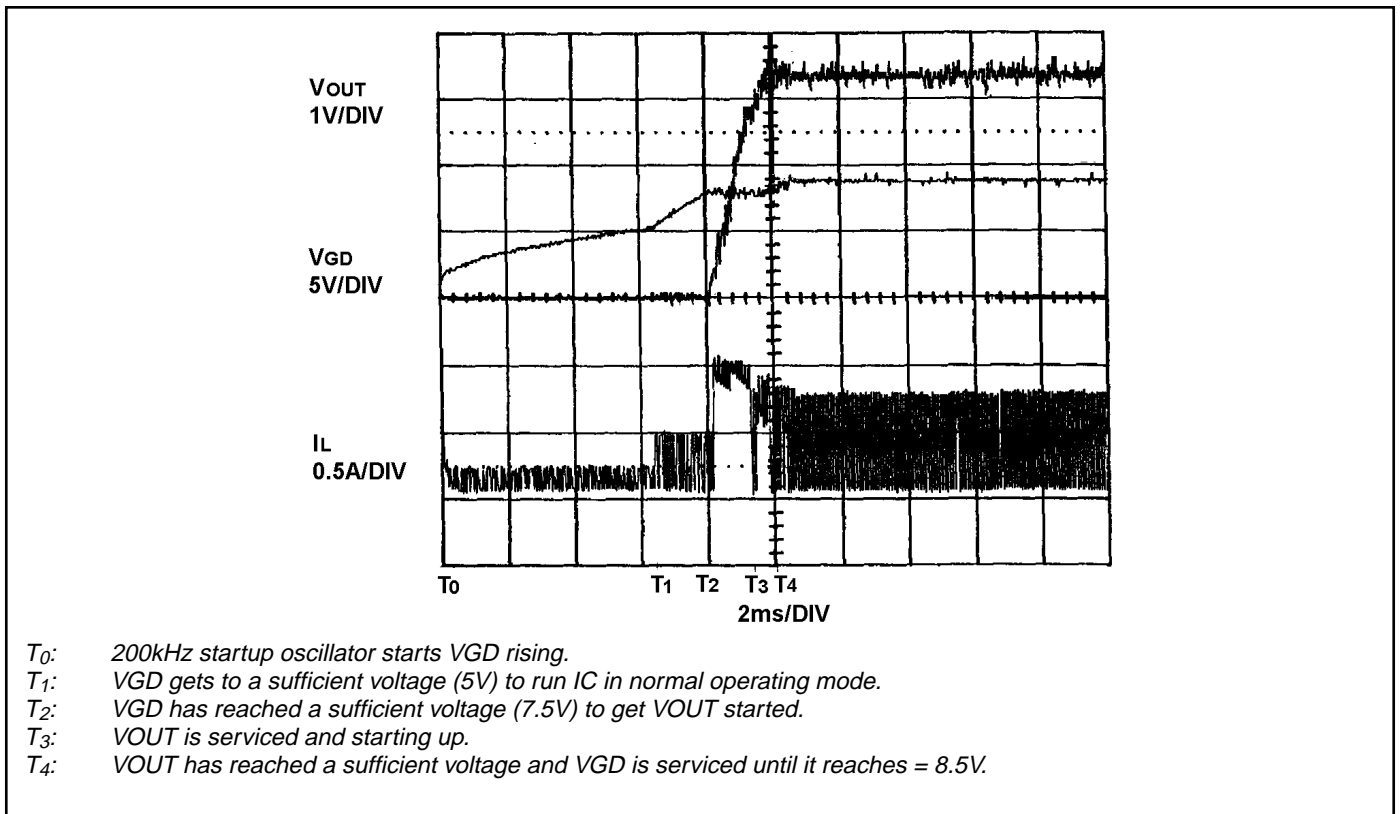

Figure 8. Startup characteristics.

APPLICATION INFORMATION (cont.)

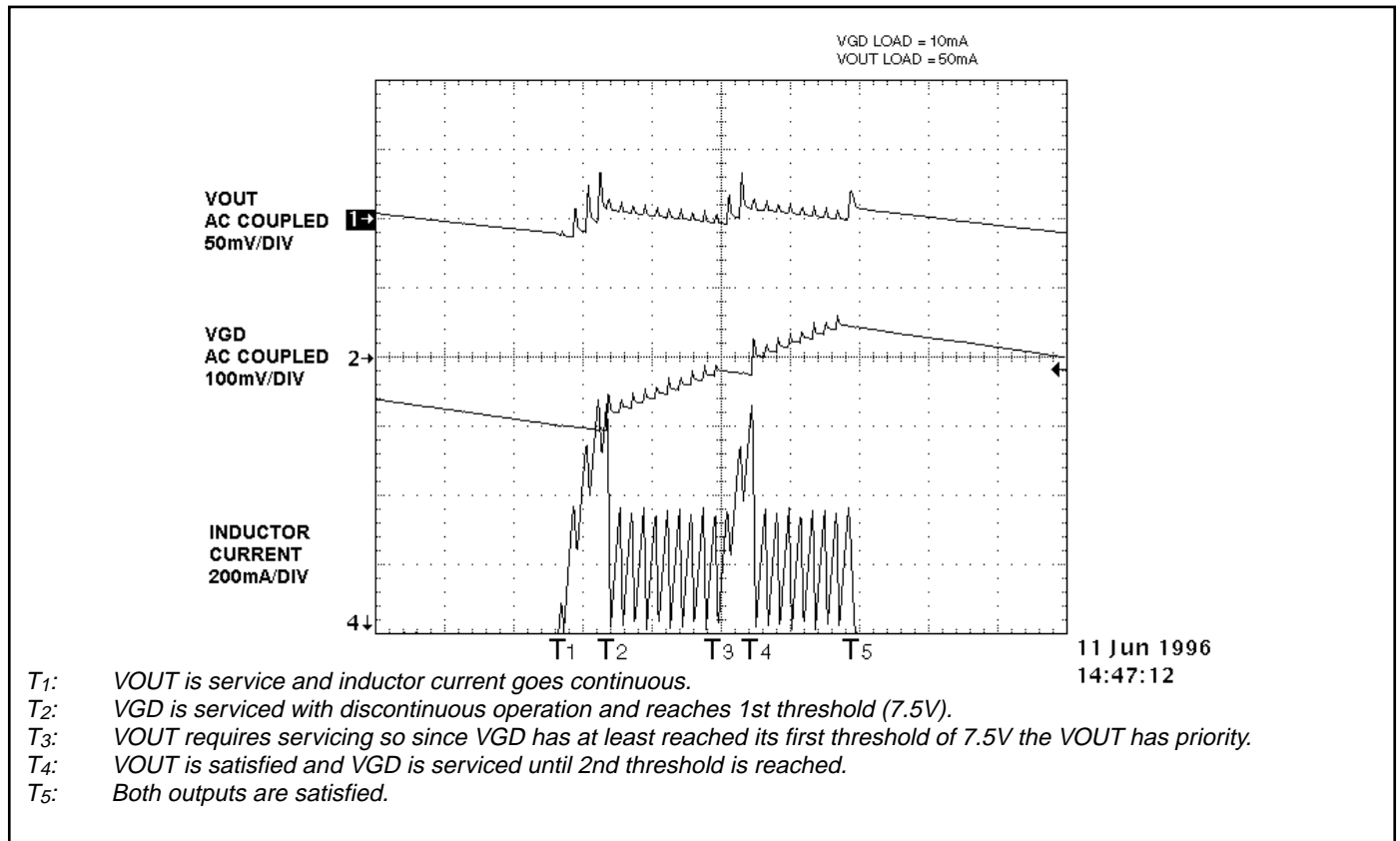

Figure 9. Dual output example.

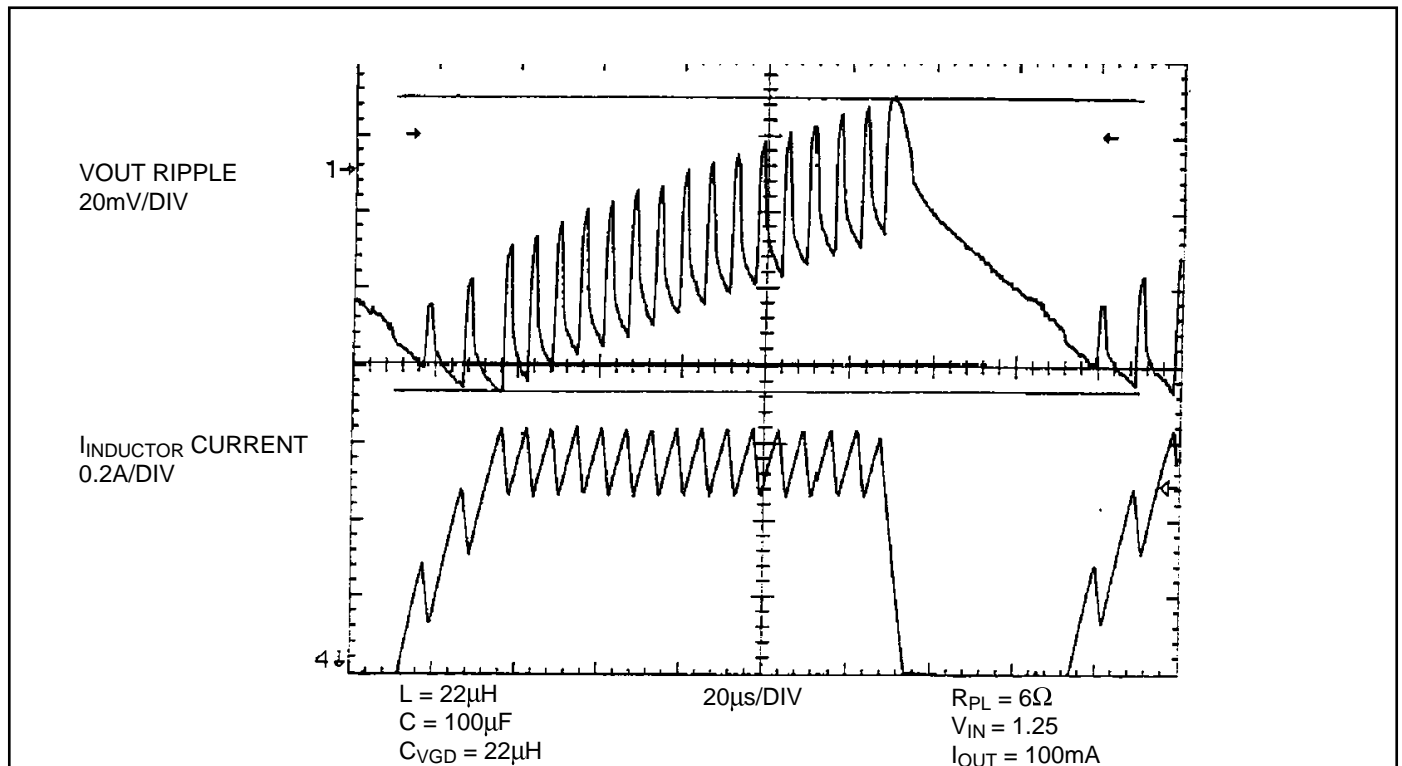

Figure 10. Pseudo continuous mode operation.

APPLICATION INFORMATION (cont.)

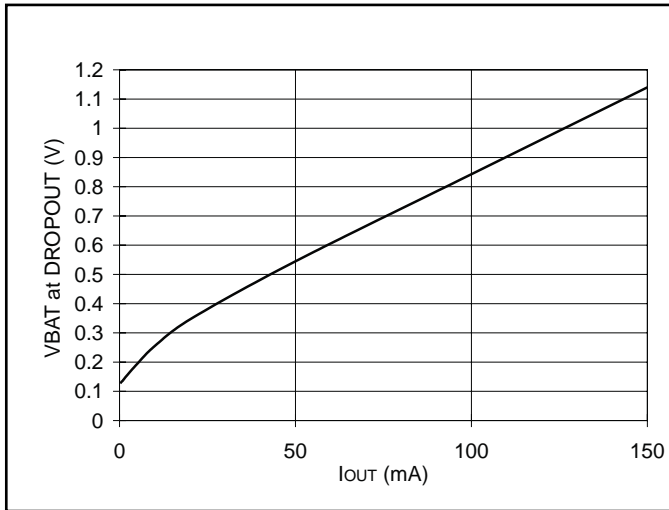

Figure 11. UCC3941-3 Dropout vs. I_{OUT} .

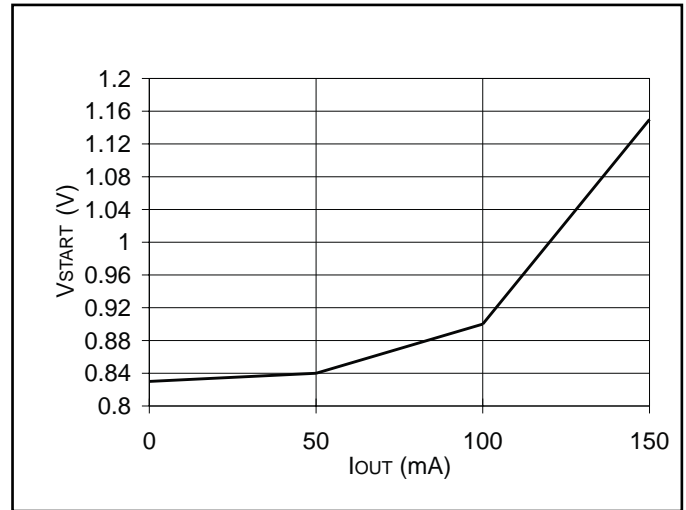

Figure 12. Minimum start voltage vs. I_{OUT} .

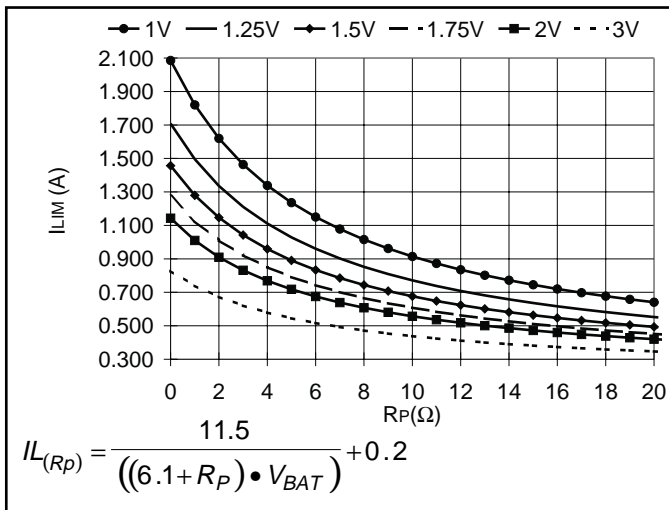

Figure 13. UCC3941-ADJ I_{LIM} vs. R_P (J package only).

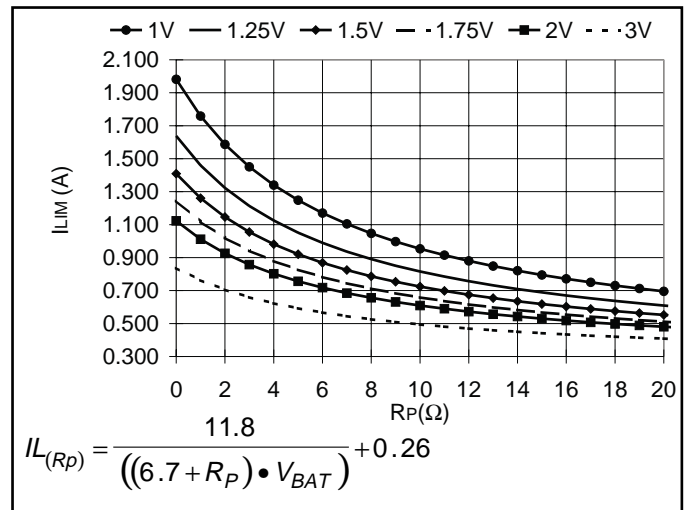

Figure 14. UCC3941-ADJ I_{LIM} vs. R_P (all other packages).

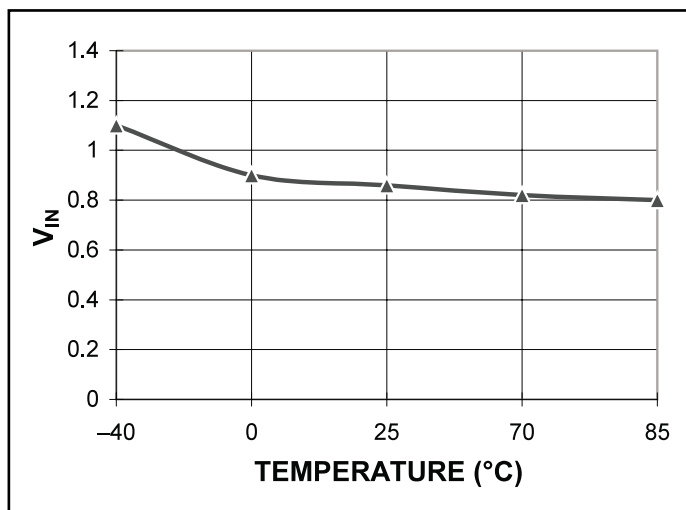

Figure 15. V_{IN} startup vs. temp.

IMPORTANT NOTICE

Texas Instruments and its subsidiaries (TI) reserve the right to make changes to their products or to discontinue any product or service without notice, and advise customers to obtain the latest version of relevant information to verify, before placing orders, that information being relied on is current and complete. All products are sold subject to the terms and conditions of sale supplied at the time of order acknowledgement, including those pertaining to warranty, patent infringement, and limitation of liability.

TI warrants performance of its semiconductor products to the specifications applicable at the time of sale in accordance with TI's standard warranty. Testing and other quality control techniques are utilized to the extent TI deems necessary to support this warranty. Specific testing of all parameters of each device is not necessarily performed, except those mandated by government requirements.

CERTAIN APPLICATIONS USING SEMICONDUCTOR PRODUCTS MAY INVOLVE POTENTIAL RISKS OF DEATH, PERSONAL INJURY, OR SEVERE PROPERTY OR ENVIRONMENTAL DAMAGE ("CRITICAL APPLICATIONS"). TI SEMICONDUCTOR PRODUCTS ARE NOT DESIGNED, AUTHORIZED, OR WARRANTED TO BE SUITABLE FOR USE IN LIFE-SUPPORT DEVICES OR SYSTEMS OR OTHER CRITICAL APPLICATIONS. INCLUSION OF TI PRODUCTS IN SUCH APPLICATIONS IS UNDERSTOOD TO BE FULLY AT THE CUSTOMER'S RISK.

In order to minimize risks associated with the customer's applications, adequate design and operating safeguards must be provided by the customer to minimize inherent or procedural hazards.

TI assumes no liability for applications assistance or customer product design. TI does not warrant or represent that any license, either express or implied, is granted under any patent right, copyright, mask work right, or other intellectual property right of TI covering or relating to any combination, machine, or process in which such semiconductor products or services might be or are used. TI's publication of information regarding any third party's products or services does not constitute TI's approval, warranty or endorsement thereof.