

COMMON MODE CHOKES

For LAN and Telecom Applications

CMC00100

- Designed to reduce EMI and common mode noise
- Common mode attenuation from 100kHz to 500MHz
- Operating temperature 0° to 70° C
- Multiple signal lines and packaging options available
- Low profile, SMT packaging rated to withstand 225° C peak IR reflow temperature
- Minimum interwinding breakdown voltage of 1500 Vrms

ELECTRICAL SPECIFICATIONS AT 25° C

Part Number	Number of Lines (winding x core)	OCL μH min	Common Mode Attenuation dB typ								DCR Ω max
			300kHz	1MHz	10MHz	30MHz	50MHz	100MHz	300MHz	500MHz	
Surface Mount											
S555-5999-41	4 (4 x 1)	20	-16	-25	-37	-42	-41	-42	-34	-31	0.50
S555-5999-40	4 (4 x 1)	24	-10	-22	-30	-29	-27	-23	-10	-2	0.35
S555-5999-15	4 (2 x 2)	38	-10	-17	-29	-35	-36	-36	-23	-15	0.30
S555-0139-01	4 (2 x 2)	80	-11	-21	-30	-32	-33	-32	-20	-9	0.95
S555-5999-02	4 (2 x 2)	140	-17	-27	-40	-45	-43	-38	-22	-11	0.80
S555-6400-08	4 (4 x 1)	4700	-40	-50	-38	-28	-22	-11	-4	---	1.00
S555-2940-00	6 (2 x 3)	80	-12	-19	-29	-30	-29	-28	-20	-12	0.20
S555-1084-00	8 (2 x 4)	24	-5	-12	-27	-32	-34	-32	-20	-11	0.30
S555-5999-39	8 (2 x 4)	350	-21	-28	-35	-29	-25	-19	-10	-4	0.20
S553-5999-D6	16 (2 x 8)	85	-17	-27	-37	-38	-36	-30	-12	-2	0.30
Through Hole											
0553-3965-08	2 (2 x 1)	140	-16	-26	-38	-43	-45	-42	-24	-16	0.80
0555-3001-08	4 (2 x 2)	120	-16	-26	-39	-45	-44	-38	-20	-15	0.80
0555-6400-06	4 (4 x 1)	4700	-44	-50	-37	-27	-21	-8	---	---	1.00

©2003 Bel Fuse Inc. Specifications subject to change without notice. 03.03

COMMON MODE CHOKES For LAN and Telecom Applications

SCHEMATICS

0553-3965-08



0555-3001-08

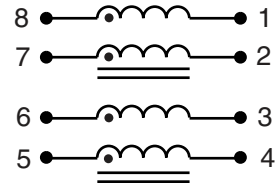

0555-6400-06

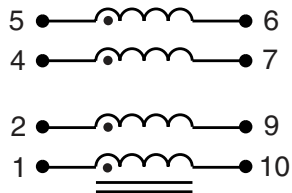

S553-5999-D6

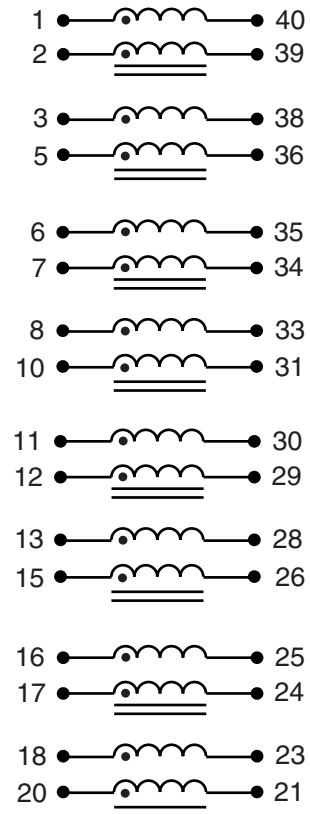

S555-0139-01

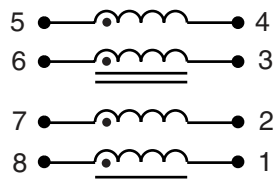

COMMON MODE CHOKES

For LAN and Telecom Applications

SCHEMATICS

S555-1084-00
S555-5999-39

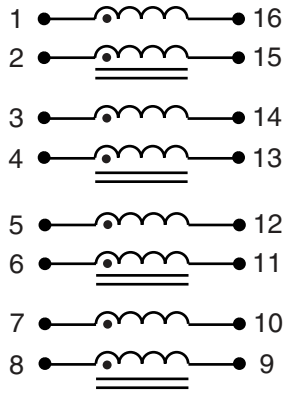

S555-2940-00

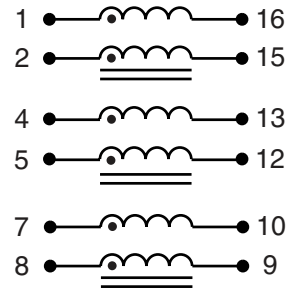

S555-5999-02
S555-5999-15

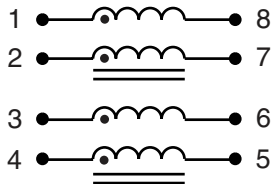

S555-5999-40
S555-5999-41

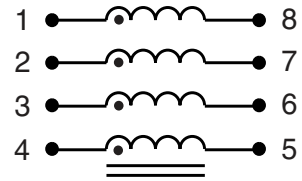

S555-6400-08

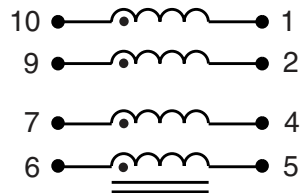

COMMON MODE CHOKES For LAN and Telecom Applications

CMC00100

MECHANICALS

0553-3965-08

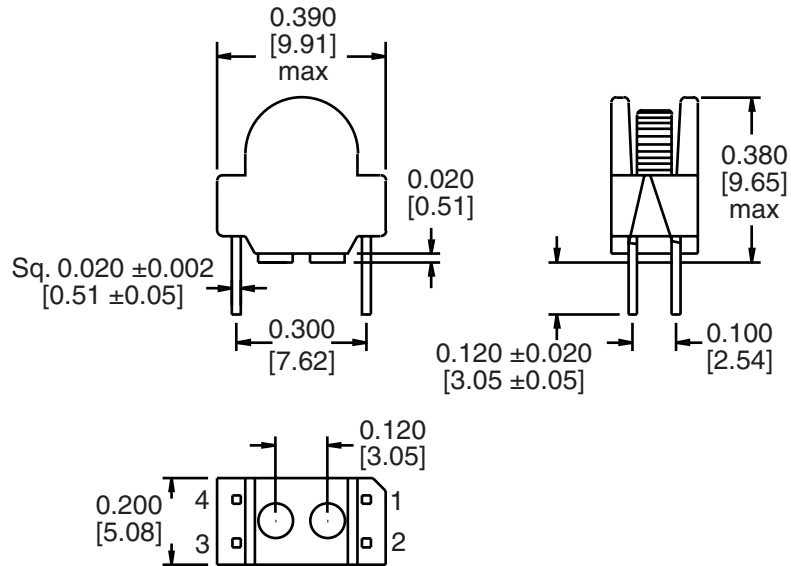

Dimensions are in inches [millimeters].
Standard dimension tolerance is ±0.005 [0.13] unless otherwise noted.

0555-3001-08

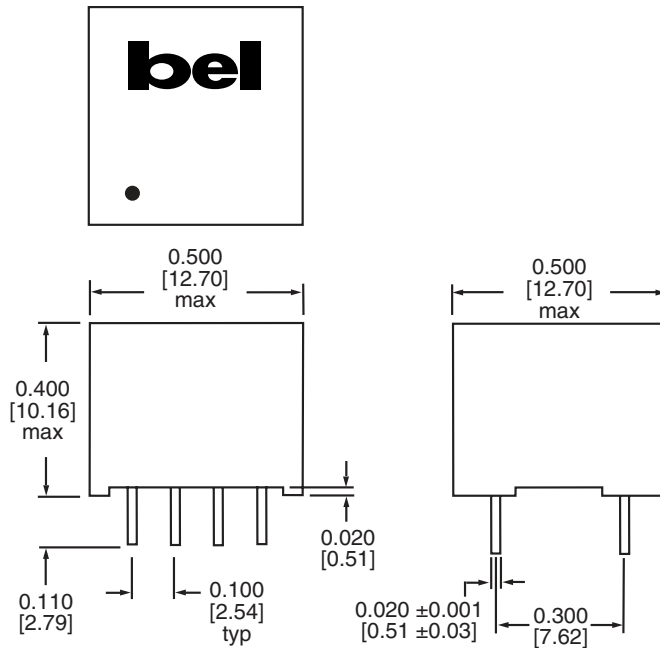

Dimensions are in inches [millimeters].
Standard dimension tolerance is ±0.005 [0.13] unless otherwise noted.

COMMON MODE CHOKES

For LAN and Telecom Applications

MECHANICALS

0555-6400-06

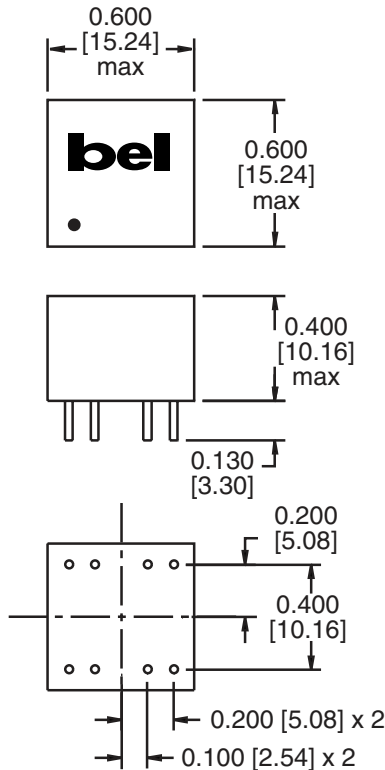

Dimensions are in inches [millimeters].
Standard dimension tolerance is ± 0.005 [0.13] unless otherwise noted.

S553-5999-D6

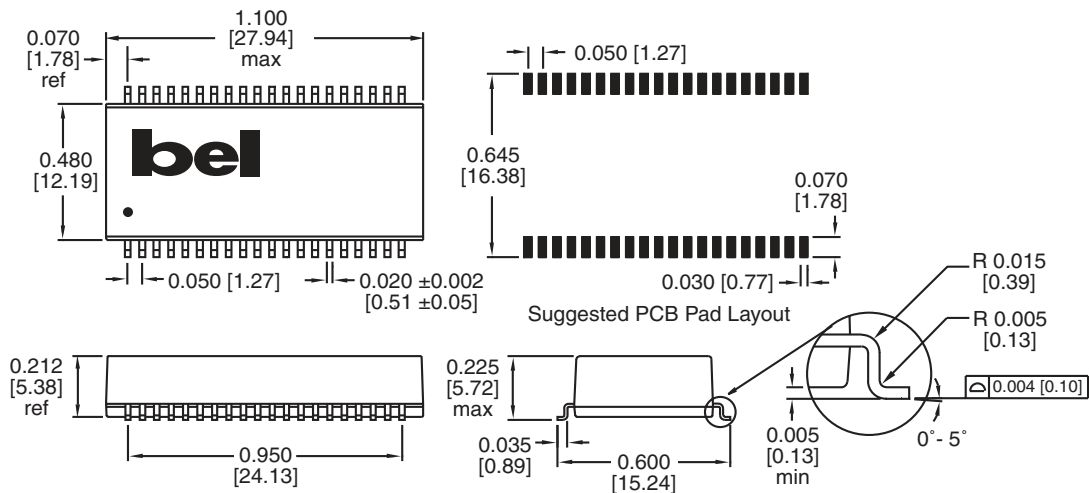

Dimensions are in inches [millimeters].
Standard dimension tolerance is ± 0.005 [0.13] unless otherwise noted.

CMC00100

MECHANICALS

S555-0139-01

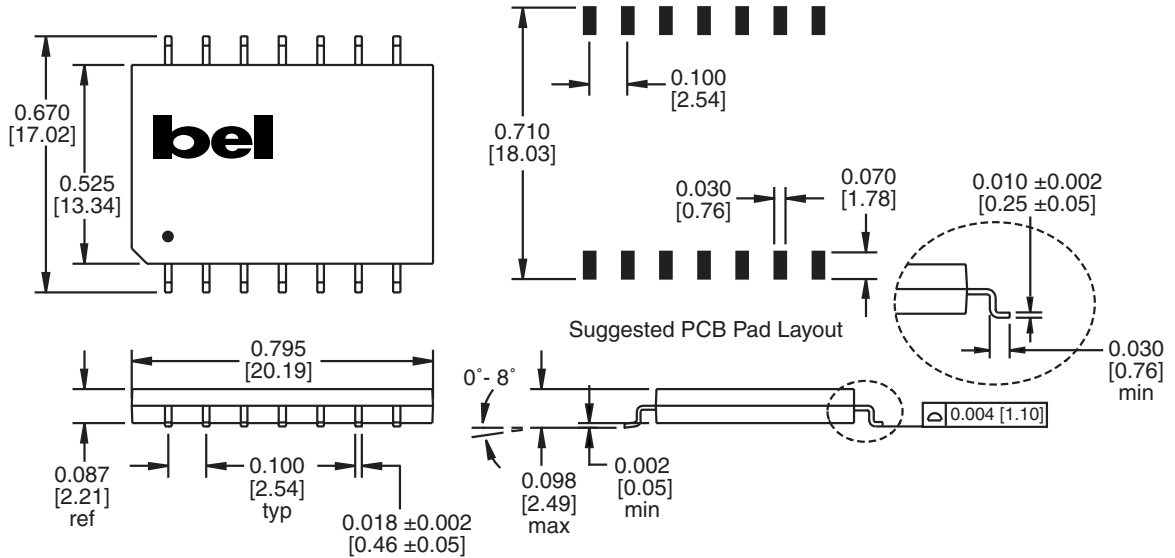

Dimensions are in inches [millimeters].
Standard dimension tolerance is ± 0.005 [0.13] unless otherwise noted.

S555-1084-00
S555-2940-00
S555-5999-39

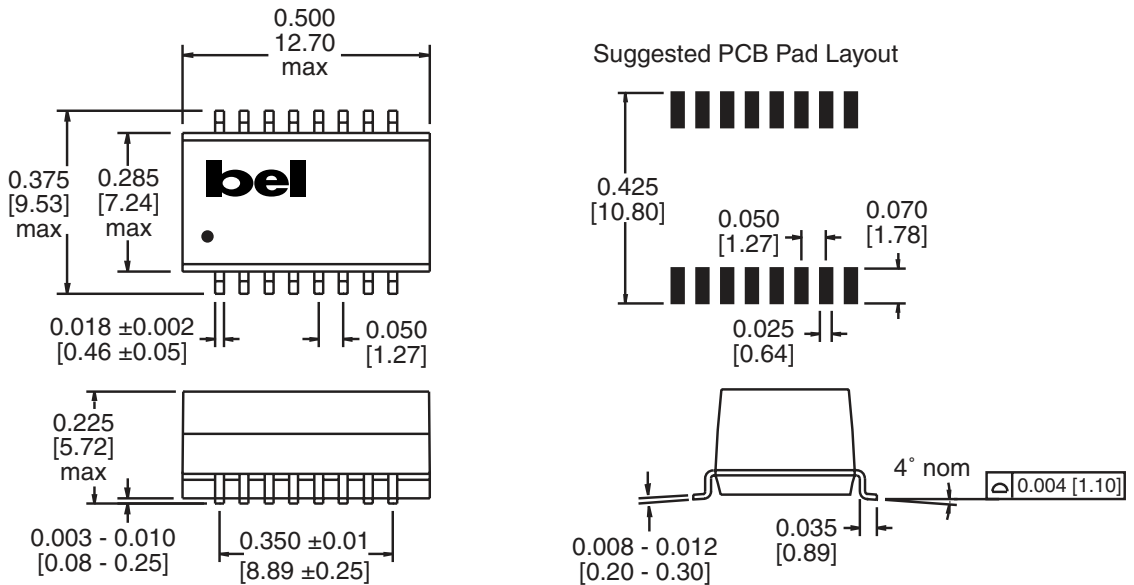

Dimensions are in inches [millimeters].
Standard dimension tolerance is ± 0.005 [0.13] unless otherwise noted.

COMMON MODE CHOKES

For LAN and Telecom Applications

MECHANICALS

S555-5999-02

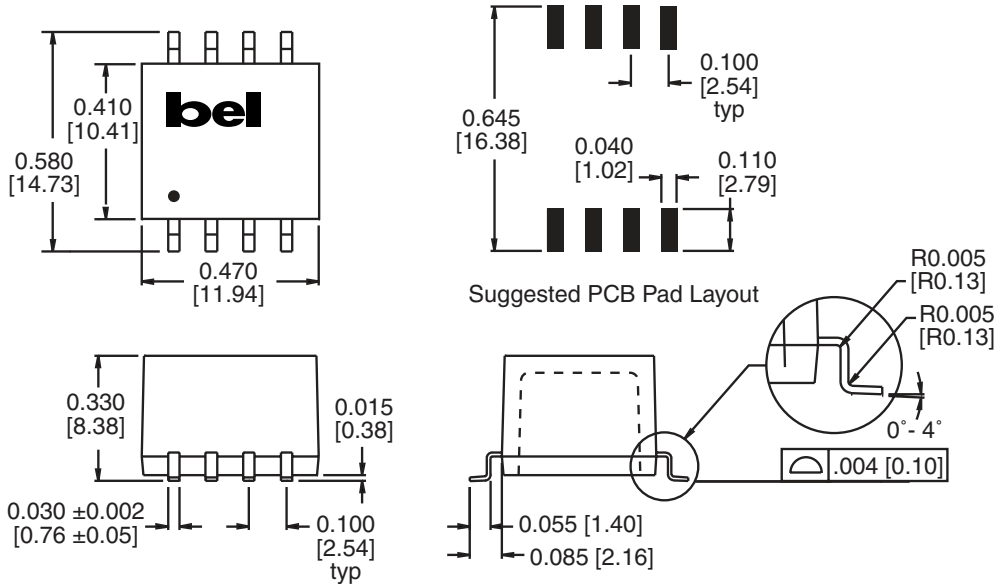

Dimensions are in inches [millimeters].
Standard dimension tolerance is ±0.005 [0.13] unless otherwise noted.

S555-5999-15

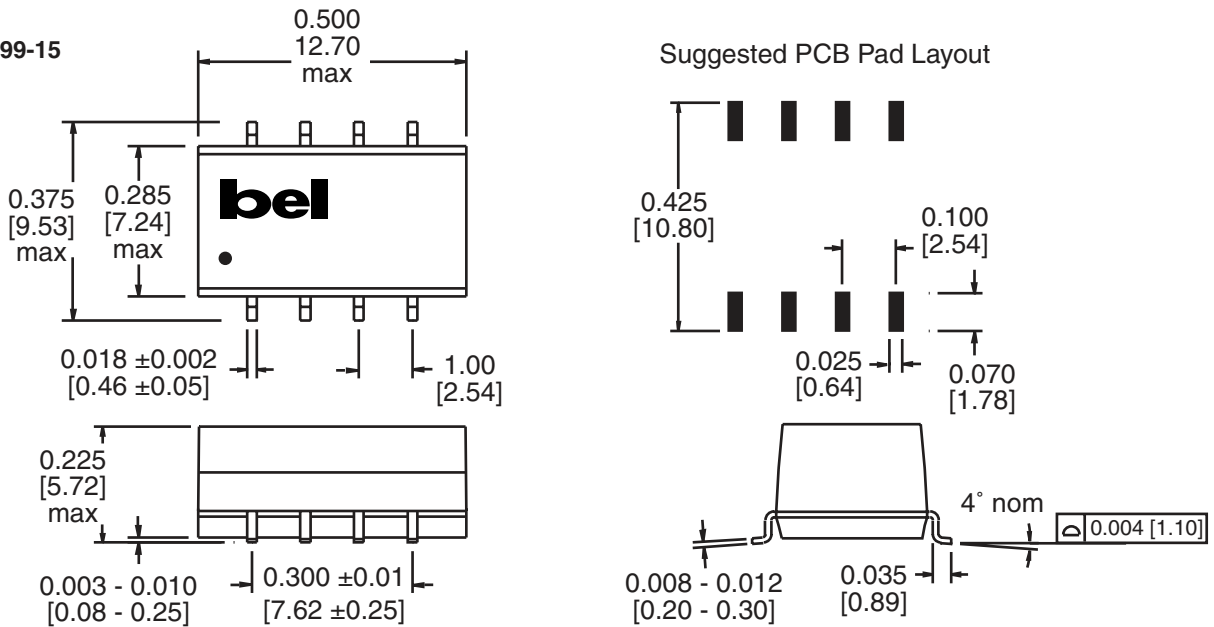

Dimensions are in inches [millimeters].
Standard dimension tolerance is ±0.005 [0.13] unless otherwise noted.

CMC00100

MECHANICALS

S555-5999-40

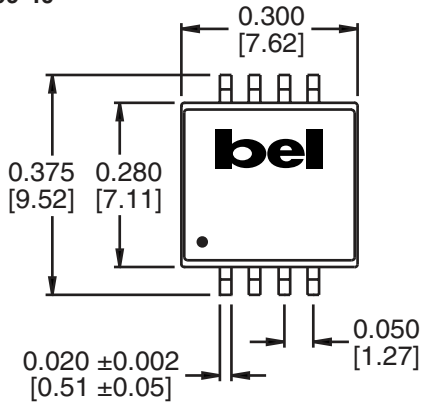

Suggested PCB Pad Layout

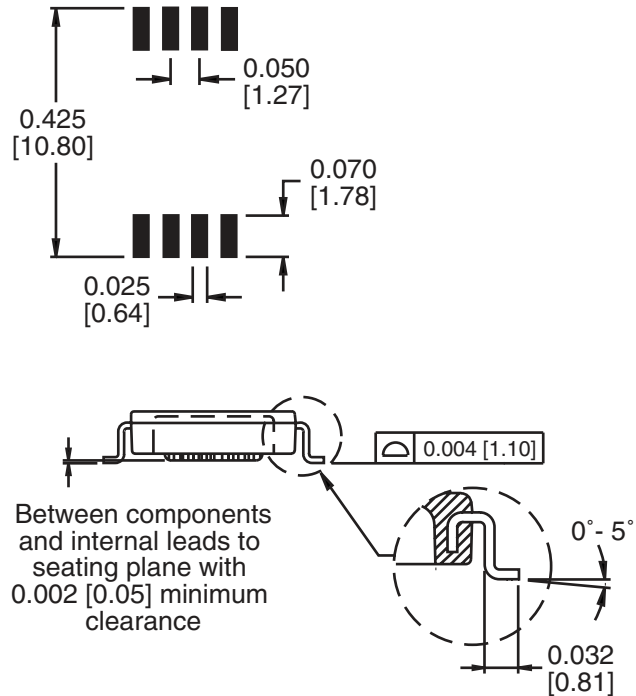

S555-5999-41

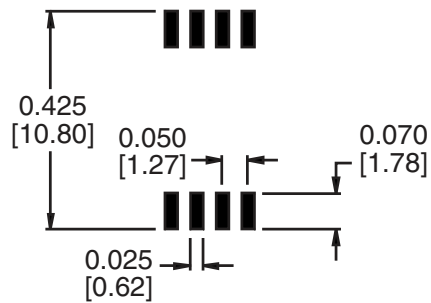
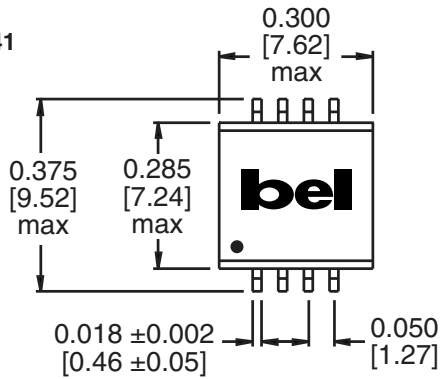

Suggested PCB Pad Layout

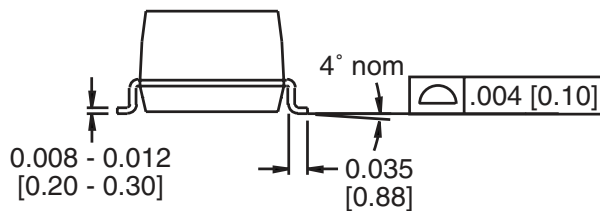

Dimensions are in inches [millimeters].
 Standard dimension tolerance is ±0.005 [0.13] unless otherwise noted.

COMMON MODE CHOKES
For LAN and Telecom Applications

MECHANICALS

S555-6400-08

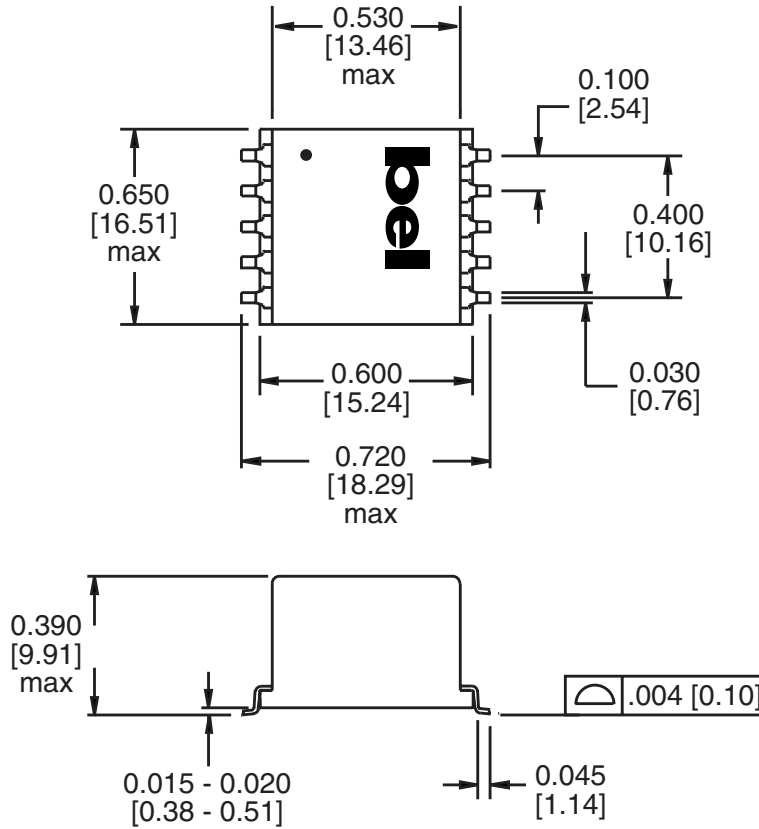

Dimensions are in inches [millimeters].
 Standard dimension tolerance is ± 0.005 [0.13] unless otherwise noted.

COMMON MODE CHOKES For LAN and Telecom Applications

COMMON MODE TEST CIRCUIT

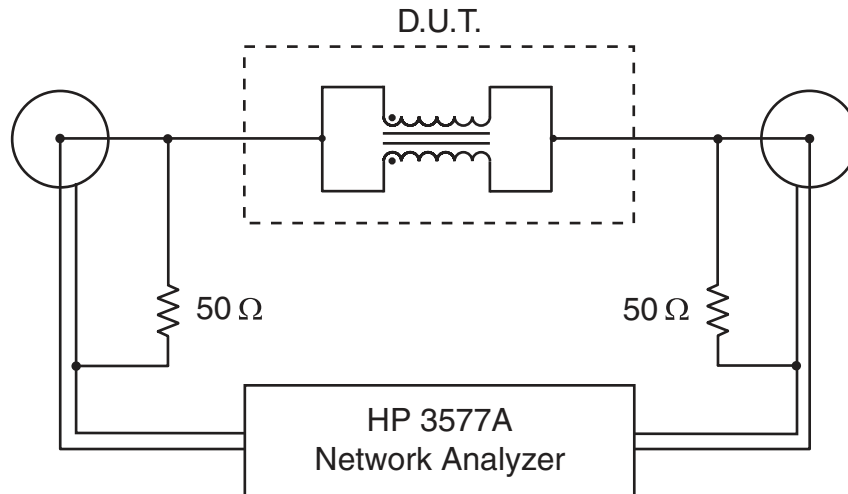

CORPORATE

Bel Fuse Inc.
206 Van Vorst Street
Jersey City, NJ 07302
Tel 201-432-0463
Fax 201-432-9542
www.belfuse.com

CMC-10

FAR EAST

Bel Fuse Ltd.
8F / 8 Luk Hop Street
San Po Kong
Kowloon, Hong Kong
Tel 852-2328-5515
Fax 852-2352-3706
www.belfuse.com

EUROPE

Bel Fuse Europe Ltd.
Preston Technology Management Centre
Marsh Lane, Suite G7, Preston
Lancashire, PR1 8UD, U.K.
Tel 44-1772-556601
Fax 44-1772-888366
www.belfuse.com