

## Trench gate field-stop 650 V, 80 A high speed HB series IGBT

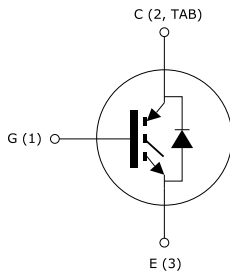
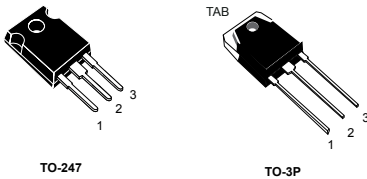

## Features

- Maximum junction temperature:  $T_J = 175\text{ }^\circ\text{C}$
- High speed switching series
- Minimized tail current
- Low saturation voltage:  $V_{CE(sat)} = 1.6\text{ V (typ.) @ } I_C = 80\text{ A}$
- Tight parameter distribution
- Safe paralleling
- Positive  $V_{CE(sat)}$  temperature coefficient
- Low thermal resistance
- Very fast soft recovery antiparallel diode

## Applications

- Photovoltaic inverters
- High frequency converters

## Description

These devices are IGBTs developed using an advanced proprietary trench gate field-stop structure. These devices are part of the new HB series of IGBTs, which represent an optimum compromise between conduction and switching loss to maximize the efficiency of any frequency converter. Furthermore, the slightly positive  $V_{CE(sat)}$  temperature coefficient and very tight parameter distribution result in safer paralleling operation.

## Product status link

[STGW80H65DFB](#)
[STGWT80H65DFB](#)

## Product summary

Order code	STGW80H65DFB
Marking	GW80H65DFB
Package	TO-247
Packing	Tube
Order code	STGWT80H65DFB
Marking	GWT80H65DFB
Package	TO-3P
Packing	Tube

# 1 Electrical ratings

**Table 1. Absolute maximum ratings**

Symbol	Parameter	Value	Unit
$V_{CES}$	Collector-emitter voltage ( $V_{GE} = 0$ )	650	V
$I_C$	Continuous collector current at $T_C = 25\text{ °C}$	120 <sup>(1)</sup>	A
	Continuous collector current at $T_C = 100\text{ °C}$	80	
$I_{CP}$ <sup>(2)</sup>	Pulsed collector current ( $t_p \leq 1\ \mu\text{s}$ , $T_J < 175\text{ °C}$ )	300	A
$V_{GE}$	Gate-emitter voltage	$\pm 20$	V
	Transient gate-emitter voltage	$\pm 30$	V
$I_F$	Continuous forward current at $T_C = 25\text{ °C}$	120 <sup>(1)</sup>	A
	Continuous forward current at $T_C = 100\text{ °C}$	80	
$I_{FP}$ <sup>(2)</sup>	Pulsed forward current ( $t_p \leq 1\ \mu\text{s}$ , $T_J < 175\text{ °C}$ )	300	A
$P_{TOT}$	Total power dissipation at $T_C = 25\text{ °C}$	470	W
$T_{STG}$	Storage temperature range	- 55 to 150	°C
$T_J$	Operating junction temperature range	- 55 to 175	

1. Current level is limited by bond wires
2. Defined by design, not subject to production test.

**Table 2. Thermal data**

Symbol	Parameter	Value	Unit
$R_{thJC}$	Thermal resistance junction-case IGBT	0.32	°C/W
$R_{thJC}$	Thermal resistance junction-case diode	0.66	
$R_{thJA}$	Thermal resistance junction-ambient	50	

## 2 Electrical characteristics

$T_C = 25\text{ °C}$  unless otherwise specified

**Table 3. Static characteristics**

Symbol	Parameter	Test conditions	Min.	Typ.	Max.	Unit
$V_{(BR)CES}$	Collector-emitter breakdown voltage	$V_{GE} = 0\text{ V}, I_C = 2\text{ mA}$	650			V
$V_{CE(sat)}$	Collector-emitter saturation voltage	$V_{GE} = 15\text{ V}, I_C = 80\text{ A}$		1.6	2	V
		$V_{GE} = 15\text{ V}, I_C = 80\text{ A}, T_J = 125\text{ °C}$		1.8		
		$V_{GE} = 15\text{ V}, I_C = 80\text{ A}, T_J = 175\text{ °C}$		1.9		
$V_F$	Forward on-voltage	$I_F = 80\text{ A}$		1.9	2.3	V
		$I_F = 80\text{ A}, T_J = 125\text{ °C}$		1.6		
		$I_F = 80\text{ A}, T_J = 175\text{ °C}$		1.5		
$V_{GE(th)}$	Gate threshold voltage	$V_{CE} = V_{GE}, I_C = 1\text{ mA}$	5	6	7	V
$I_{CES}$	Collector cut-off current	$V_{GE} = 0\text{ V}, V_{CE} = 650\text{ V}$			100	$\mu\text{A}$
$I_{GES}$	Gate-emitter leakage current	$V_{CE} = 0\text{ V}, V_{GE} = \pm 20\text{ V}$			$\pm 250$	nA

**Table 4. Dynamic characteristics**

Symbol	Parameter	Test conditions	Min.	Typ.	Max.	Unit
$C_{ies}$	Input capacitance	$V_{CE} = 25\text{ V}, f = 1\text{ MHz}, V_{GE} = 0\text{ V}$	-	10524	-	$\mu\text{F}$
$C_{oes}$	Output capacitance		-	385	-	
$C_{res}$	Reverse transfer capacitance		-	215	-	
$Q_g$	Total gate charge	$V_{CC} = 520\text{ V}, I_C = 80\text{ A}, V_{GE} = 15\text{ V}$ (see <a href="#">Figure 29. Gate charge test circuit</a> )	-	414	-	nC
$Q_{ge}$	Gate-emitter charge		-	78	-	
$Q_{gc}$	Gate-collector charge		-	170	-	

**Table 5. IGBT switching characteristics (inductive load)**

Symbol	Parameter	Test conditions	Min.	Typ.	Max.	Unit
$t_{d(on)}$	Turn-on delay time	$V_{CE} = 400\text{ V}$ , $I_C = 80\text{ A}$ , $V_{GE} = 15\text{ V}$ , $R_G = 10\ \Omega$ (see Figure 28. Test circuit for inductive load switching)		84	-	ns
$t_r$	Current rise time			52	-	
$(di/dt)_{on}$	Turn-on current slope			1270	-	A/ $\mu\text{s}$
$t_{d(off)}$	Turn-off-delay time			280	-	ns
$t_f$	Current fall time			31	-	
$E_{on}^{(1)}$	Turn-on switching energy			2.1	-	mJ
$E_{off}^{(2)}$	Turn-off switching energy			1.5	-	
$E_{ts}$	Total switching energy		3.6	-		
$t_{d(on)}$	Turn-on delay time	$V_{CE} = 400\text{ V}$ , $I_C = 80\text{ A}$ , $V_{GE} = 15\text{ V}$ , $R_G = 10\ \Omega$ , $T_J = 175\text{ }^\circ\text{C}$ (see Figure 28. Test circuit for inductive load switching)		77	-	ns
$t_r$	Current rise time			51	-	
$(di/dt)_{on}$	Turn-on current slope			1270	-	A/ $\mu\text{s}$
$t_{d(off)}$	Turn-off-delay time			328	-	ns
$t_f$	Current fall time			30	-	
$E_{on}^{(1)}$	Turn-on switching energy			4.4	-	mJ
$E_{off}^{(2)}$	Turn-off switching energy			2.1	-	
$E_{ts}$	Total switching energy		6.5	-		

1. Including the reverse recovery of the diode.
2. Including the tail of the collector current.

**Table 6. Diode switching characteristics (inductive load)**

Symbol	Parameter	Test conditions	Min.	Typ.	Max.	Unit	
$t_{rr}$	Reverse recovery time	$I_F = 80\text{ A}$ , $V_R = 400\text{ V}$ , $V_{GE} = 15\text{ V}$ di/ $dt = 100\text{ A}/\mu\text{s}$ (see Figure 28. Test circuit for inductive load switching)	-	85	-	ns	
$Q_{rr}$	Reverse recovery charge			-	1105	-	nC
$I_{rrm}$	Reverse recovery current			-	26	-	A
$di_{rr}/dt$	Peak rate of fall of reverse recovery current during $t_b$			-	722	-	A/ $\mu\text{s}$
$E_{rr}$	Reverse recovery energy			-	267	-	$\mu\text{J}$
$t_{rr}$	Reverse recovery time	$I_F = 80\text{ A}$ , $V_R = 400\text{ V}$ , $V_{GE} = 15\text{ V}$ , $T_J = 175\text{ }^\circ\text{C}$ di/dt = $100\text{ A}/\mu\text{s}$ (see Figure 28. Test circuit for inductive load switching)	-	149	-	ns	
$Q_{rr}$	Reverse recovery charge			-	4920	-	nC
$I_{rrm}$	Reverse recovery current			-	66	-	A
$di_{rr}/dt$	Peak rate of fall of reverse recovery current during $t_b$			-	546	-	A/ $\mu\text{s}$
$E_{rr}$	Reverse recovery energy			-	1172	-	$\mu\text{J}$

## 2.1 Electrical characteristics (curves)

Figure 1. Power dissipation vs case temperature

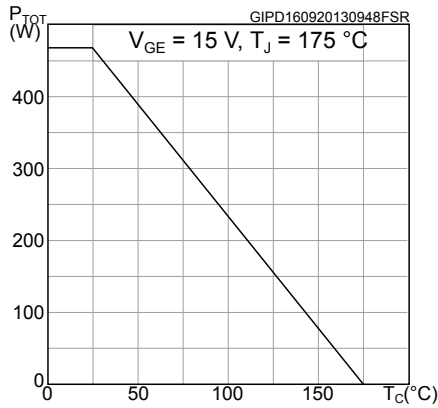

Figure 2. Collector current vs case temperature

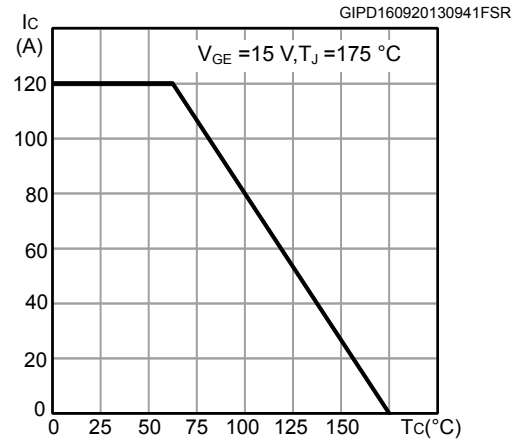

Figure 3. Output characteristics ( $T_J = 25\text{ °C}$ )

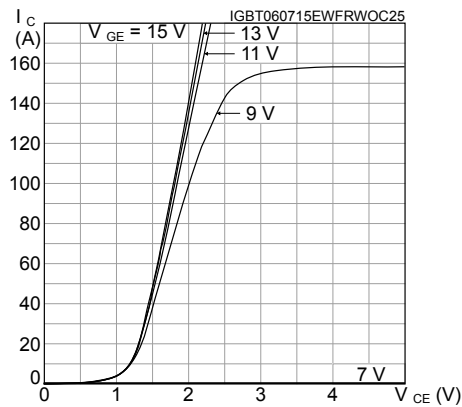

Figure 4. Output characteristics ( $T_J = 175\text{ °C}$ )

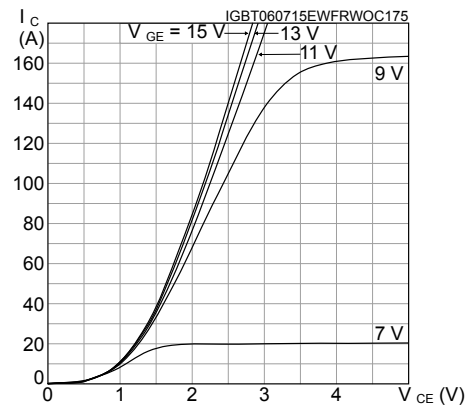

Figure 5.  $V_{CE(sat)}$  vs junction temperature

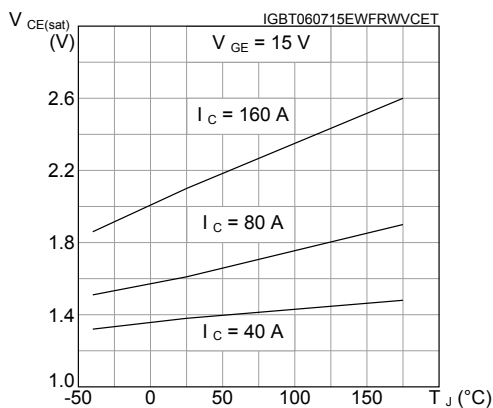

Figure 6.  $V_{CE(sat)}$  vs collector current

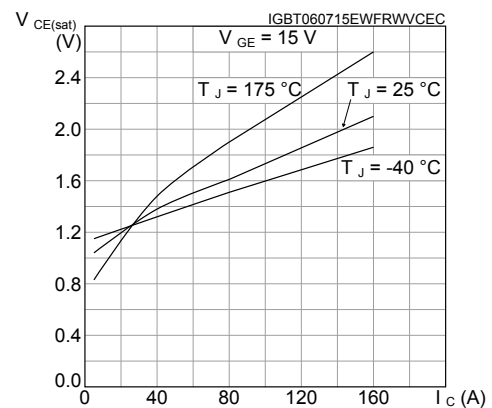

Figure 7. Collector current vs switching frequency

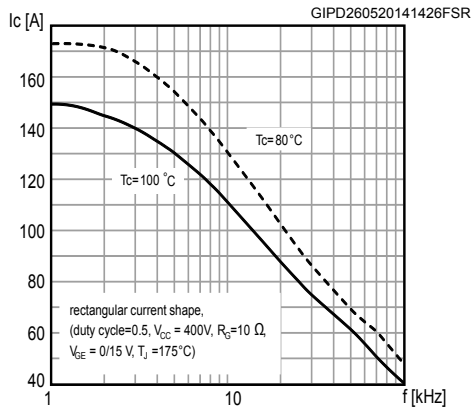

Figure 8. Forward bias safe operating area

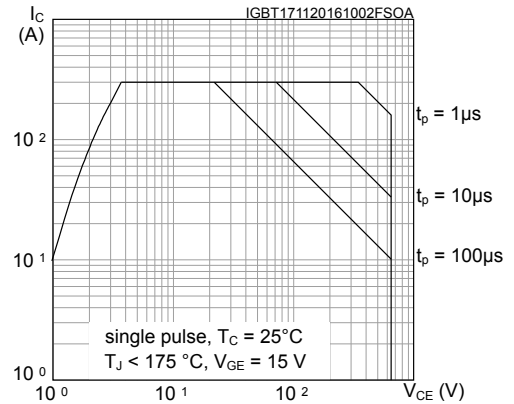

Figure 9. Transfer characteristics

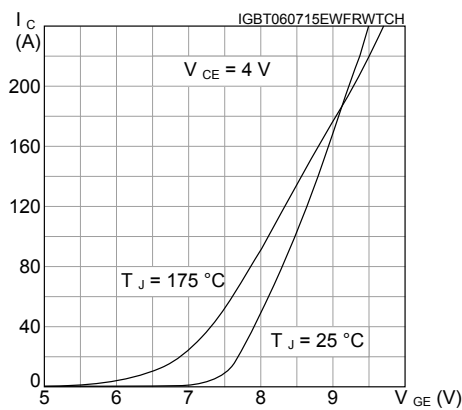

Figure 10. Diode Vf vs forward current

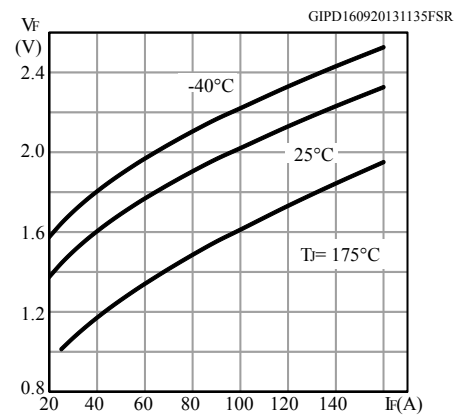

Figure 11. Normalized VGE(th) vs junction temperature

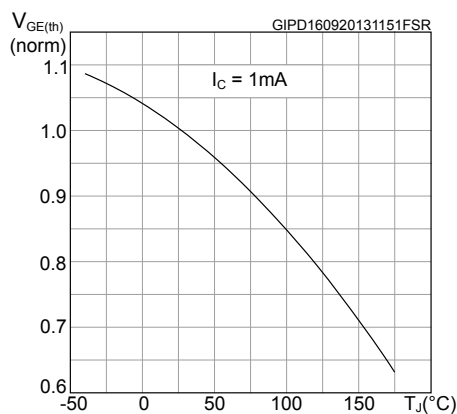
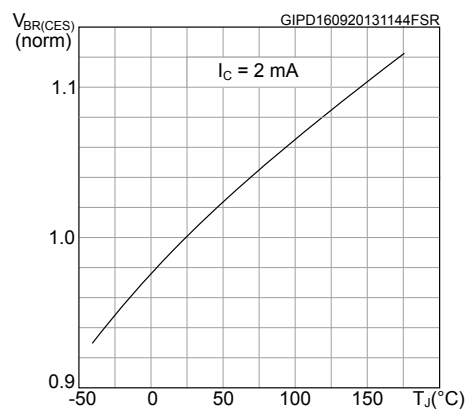
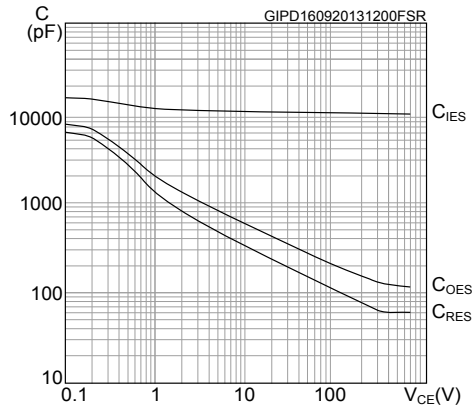
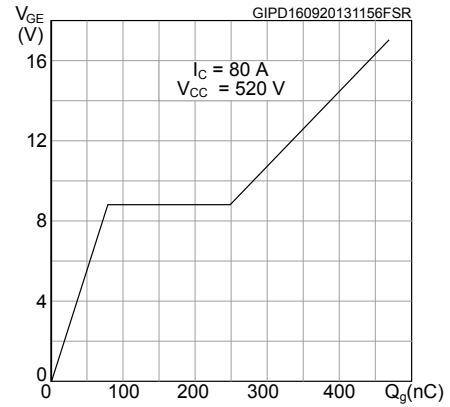
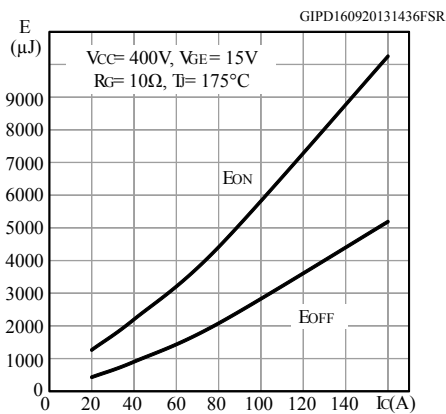
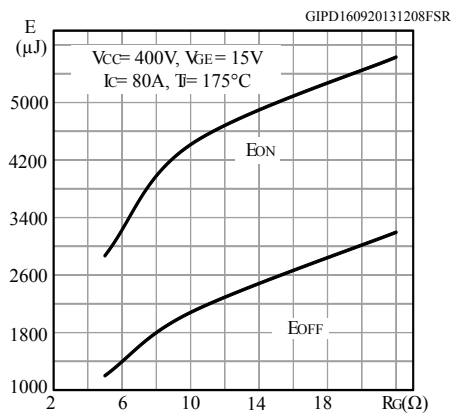
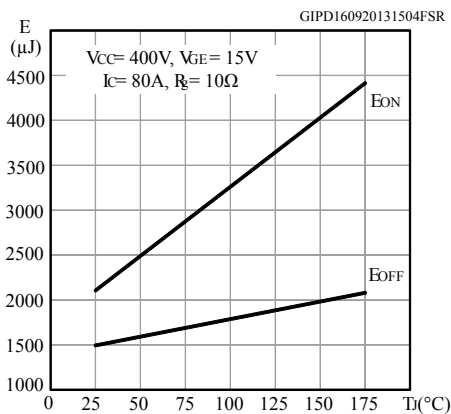
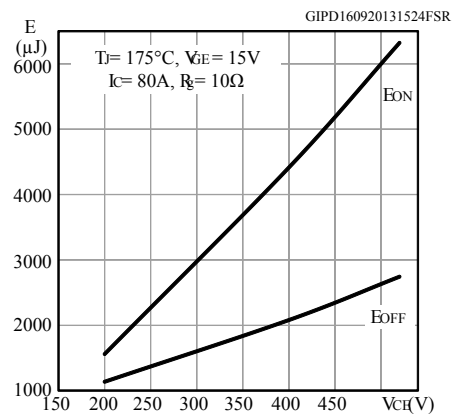
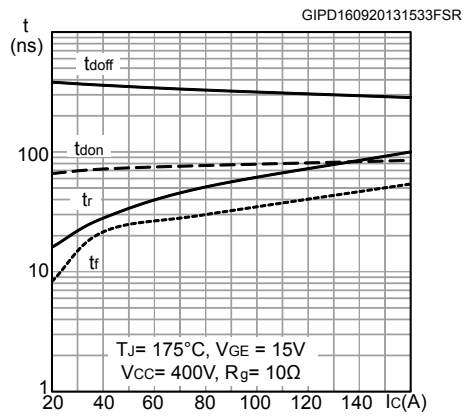
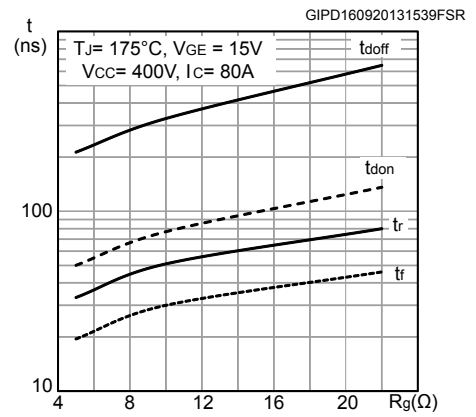
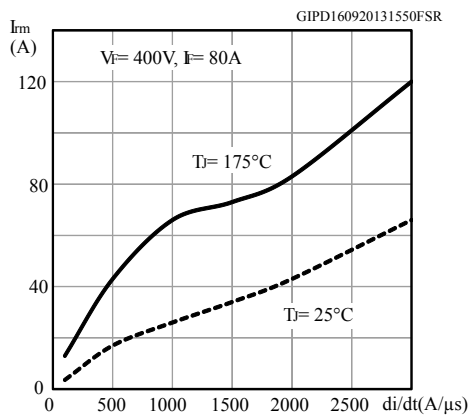
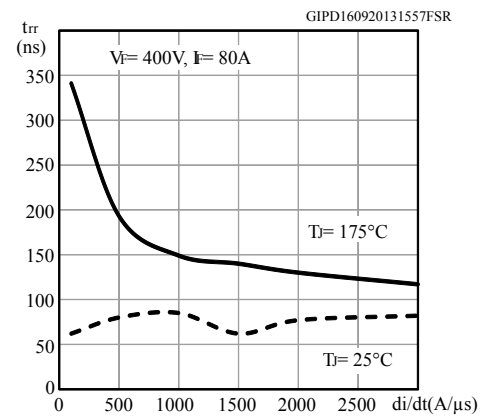
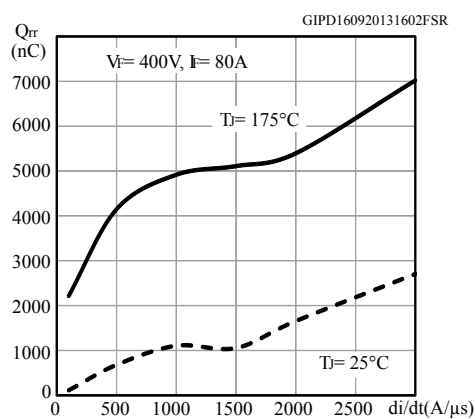
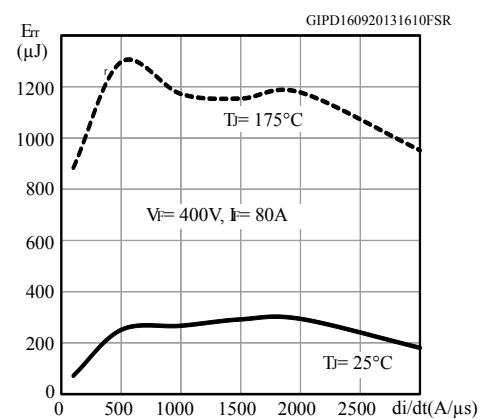

Figure 12. Normalized VBR(CES) vs junction temperature



**Figure 13. Capacitance variations**

**Figure 14. Gate charge vs gate-emitter voltage**

**Figure 15. Switching energy vs collector current**

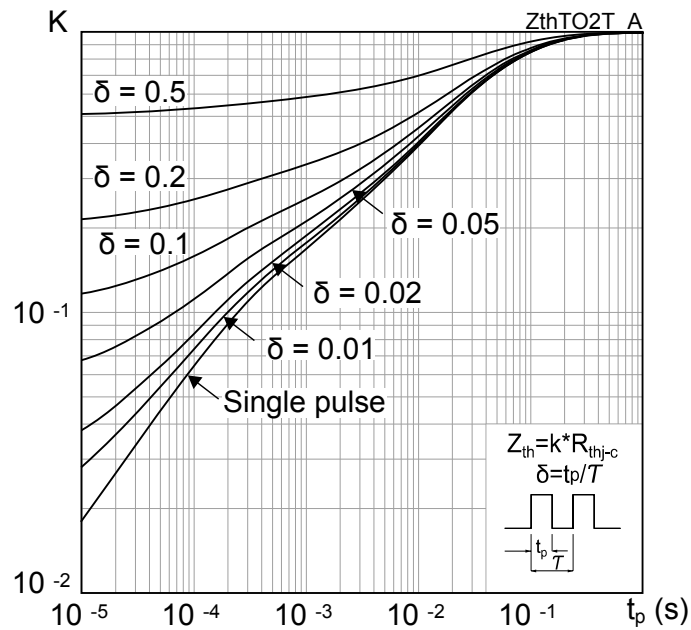
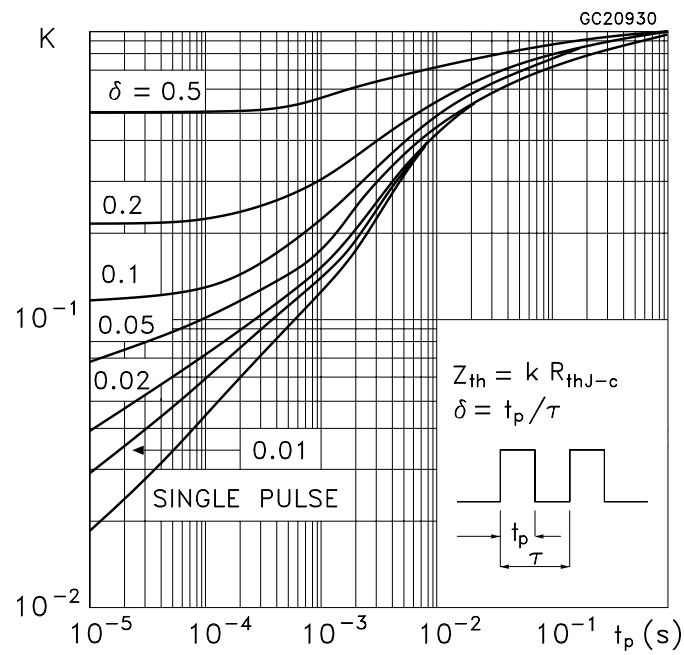
**Figure 16. Switching energy vs gate resistance**

**Figure 17. Switching energy vs temperature**

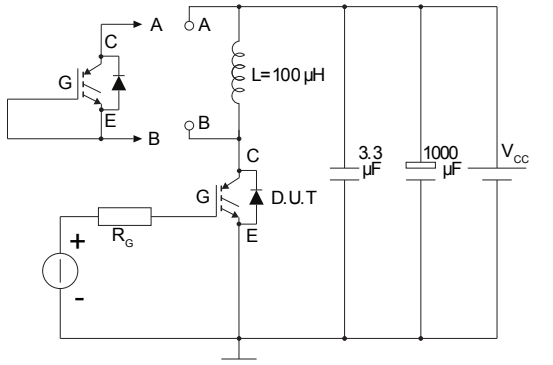
**Figure 18. Switching energy vs collector emitter voltage**

**Figure 19. Switching times vs collector current**

**Figure 20. Switching times vs gate resistance**

**Figure 21. Reverse recovery current vs diode current slope**

**Figure 22. Reverse recovery time vs diode current slope**

**Figure 23. Reverse recovery charge vs diode current slope**

**Figure 24. Reverse recovery energy vs diode current slope**

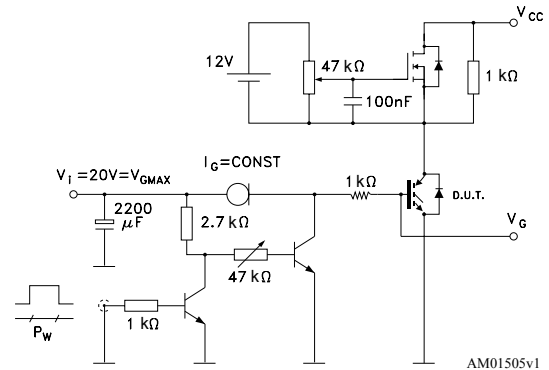

**Figure 25. Thermal impedance for IGBT**

**Figure 26. Thermal impedance for diode**

### 3 Test circuits

**Figure 27. Test circuit for inductive load switching**

AM01504v1

**Figure 28. Gate charge test circuit**

AM01505v1

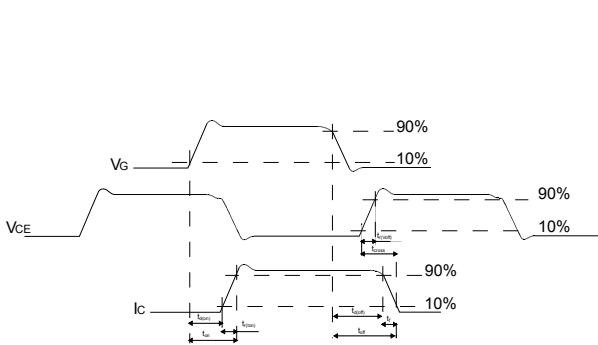
**Figure 29. Switching waveform**

AM01506v1

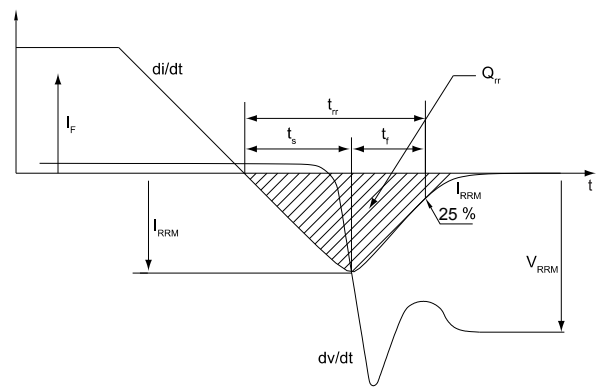
**Figure 30. Diode reverse recovery waveform**

AM01507v1

## 4 Package information

---

In order to meet environmental requirements, ST offers these devices in different grades of **ECOPACK** packages, depending on their level of environmental compliance. ECOPACK specifications, grade definitions and product status are available at: [www.st.com](http://www.st.com). ECOPACK is an ST trademark.

### 4.1 TO-247 package information

Figure 31. TO-247 package outline

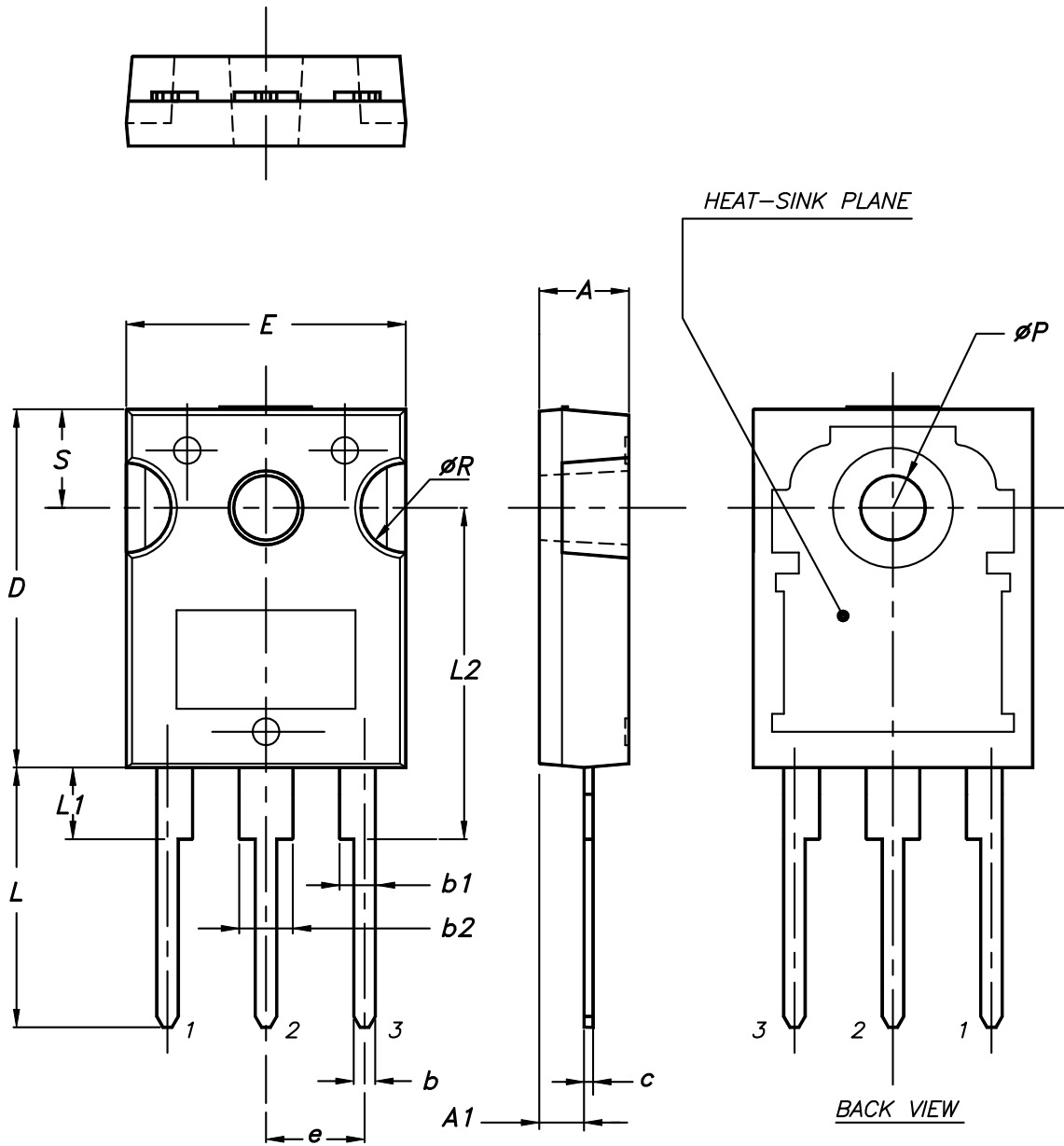

0075325\_9

Table 7. TO-247 package mechanical data

Dim.	mm		
	Min.	Typ.	Max.
A	4.85		5.15
A1	2.20		2.60
b	1.0		1.40
b1	2.0		2.40
b2	3.0		3.40
c	0.40		0.80
D	19.85		20.15
E	15.45		15.75
e	5.30	5.45	5.60
L	14.20		14.80
L1	3.70		4.30
L2		18.50	
ØP	3.55		3.65
ØR	4.50		5.50
S	5.30	5.50	5.70

## 4.2 TO-3P package information

Figure 32. TO-3P package outline

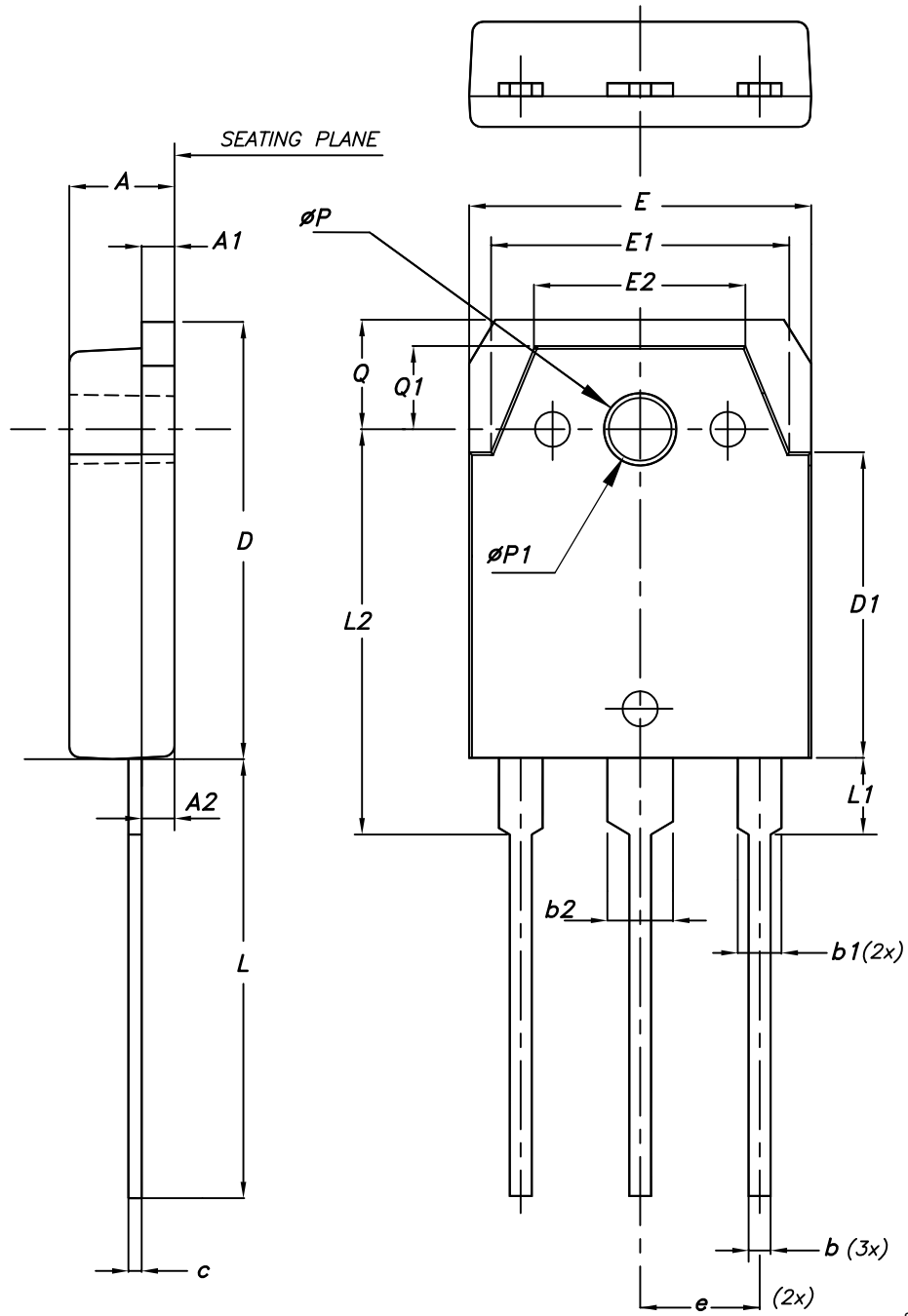

8045950\_3

Table 8. TO-3P package mechanical data

Dim.	mm		
	Min.	Typ.	Max.
A	4.60	4.80	5.00
A1	1.45	1.50	1.65
A2	1.20	1.40	1.60
b	0.80	1.00	1.20
b1	1.80	2.00	2.20
b2	2.80	3.00	3.20
c	0.55	0.60	0.75
D	19.70	19.90	20.10
D1	13.70	13.90	14.10
E	15.40	15.60	15.80
E1	13.40	13.60	13.80
E2	9.40	9.60	9.90
e	5.15	5.45	5.75
L	19.80	20.00	20.20
L1	3.30	3.50	3.70
L2	18.20	18.40	18.60
ØP	3.30	3.40	3.50
ØP1	3.10	3.20	3.30
Q	4.80	5.00	5.20
Q1	3.60	3.80	4.00

## Revision history

**Table 9. Document revision history**

Date	Revision	Changes
12-Mar-2013	1	First release.
18-Sep-2013	2	Document status promoted from preliminary to production data. Added Section 2.1: <i>Electrical characteristics (curves)</i>
20-Nov-2013	3	Added device in Max247. Modified <i>Table 1</i> accordingly. Updated <i>Section 4: Package information</i> . Minor text changes in cover page.
24-Jan-2014	4	Updated title and description in cover page. Updated <i>Table 6: IGBT switching characteristics (inductive load)</i> , <i>Table 7: Diode switching characteristics (inductive load)</i> , <i>Figure 9: Forward bias safe operating area</i> and <i>Figure 14: Switching energy vs. temperature</i> .
13-Jun-2014	5	Updated <i>Figure 5: Collector current vs. case temperature</i> , <i>Figure 6: Power dissipation vs. case temperature</i> , <i>Figure 18: Switching times vs. collector current</i> , <i>Figure 19: Switching times vs. gate resistance</i> and <i>Figure 24: Capacitance variations</i> . Added <i>Figure 25: Collector current vs. switching frequency</i> . Updated <i>Section 4: Package information</i> . Minor text changes.
07-May-2015	6	Added TO-247 long leads package information.
21-Sep-2016	7	Updated <i>Figure 2: "Output characteristics (T<sub>J</sub>= 25 °C)"</i> , <i>Figure 3: "Output characteristics (T<sub>J</sub>= 175 °C)"</i> , <i>Figure 4: "Transfer characteristics"</i> , <i>Figure 7: "VCE(sat) vs. junction temperature"</i> and <i>Figure 8: "VCE (sat) vs. collector current"</i> . The part number STGY80H65DFB has been moved to a separate datasheet. Minor text changes.
17-Nov-2016	8	Updated <i>Table 2: "Absolute maximum ratings"</i> and <i>Figure 9: "Forward bias safe operating area"</i> . The part number STGWA80H65DFB has been moved to a separate datasheet. Updated document accordingly.
14-Jun-2019	9	Modified <a href="#">Table 1. Absolute maximum ratings</a> . Updated <a href="#">Section 4.1 TO-247 package information</a> . Minor text changes.



## Contents

<b>1</b>	<b>Electrical ratings</b> .....	<b>2</b>
<b>2</b>	<b>Electrical characteristics</b> .....	<b>3</b>
<b>2.1</b>	Electrical characteristics (curves) .....	5
<b>3</b>	<b>Test circuits</b> .....	<b>10</b>
<b>4</b>	<b>Package information</b> .....	<b>11</b>
<b>4.1</b>	TO-247 package information .....	11
<b>4.2</b>	TO-3P package information .....	13
	<b>Revision history</b> .....	<b>16</b>

**IMPORTANT NOTICE – PLEASE READ CAREFULLY**

STMicroelectronics NV and its subsidiaries (“ST”) reserve the right to make changes, corrections, enhancements, modifications, and improvements to ST products and/or to this document at any time without notice. Purchasers should obtain the latest relevant information on ST products before placing orders. ST products are sold pursuant to ST’s terms and conditions of sale in place at the time of order acknowledgement.

Purchasers are solely responsible for the choice, selection, and use of ST products and ST assumes no liability for application assistance or the design of Purchasers’ products.

No license, express or implied, to any intellectual property right is granted by ST herein.

Resale of ST products with provisions different from the information set forth herein shall void any warranty granted by ST for such product.

ST and the ST logo are trademarks of ST. For additional information about ST trademarks, please refer to [www.st.com/trademarks](http://www.st.com/trademarks). All other product or service names are the property of their respective owners.

Information in this document supersedes and replaces information previously supplied in any prior versions of this document.

© 2019 STMicroelectronics – All rights reserved