



DC Fan

60×60×25 mm

San Cooler 60 9A type   



General Specifications

- Material Frame: Plastic (Flammability: UL 94V-0), Impeller: Plastic (Flammability: UL 94V-0)
- Expected life See the table below. (L10 life: 90% survival rate for continuous operation in free air at 60°C, rated voltage)
Expected life at 40°C is for reference only.
- Motor protection function Locked rotor burnout protection, Reverse polarity protection
For details, please refer to p. 599.
- Dielectric strength 50/60 Hz, 500 VAC, for 1 minute (between lead wire conductors and frame)
- Insulation resistance 10 MΩ or more with a 500 VDC megger (between lead wire conductors and frame)
- Sound pressure level (SPL) At 1 m away from the air inlet
- Storage temperature -30 to +70°C (Non-condensing)
- Lead wire ⊕Red ⊖Black or Blue Sensor Yellow
- Mass 80 g

Specifications

The models listed below **have ribs and pulse sensors**. For models without ribs, append "1" to the end of model numbers.

Model no.	Rated voltage [V]	Operating voltage range [V]	Rated current [A]	Rated input [W]	Rated speed [min ⁻¹]	Max. airflow [m ³ /min] [CFM]	Max. static pressure [Pa] [inchH ₂ O]	SPL [dB (A)]	Operating temperature [°C]	Expected life [h]		
▶▶ 9A0612G401	12	6 to 13.2	0.24	2.88	5600	0.78 27.6	87.3 0.351	39	-20 to +60	30000/60°C (53000/40°C)		
▶▶ 9A0612S401			0.17	2.04	4600	0.65 23.0	56.8 0.228	33				
▶▶ 9A0612H401		6 to 13.8	0.11	1.32	3800	0.53 18.7	40.2 0.161	28			-20 to +70	40000/60°C (70000/40°C)
▶▶ 9A0612F401			0.09	1.08	3200	0.44 15.5	29.4 0.118	24				
▶▶ 9A0612M401			0.06	0.72	2600	0.36 12.7	19.6 0.079	20				
▶▶ 9A0624G401	24	12 to 27.6	0.13	3.12	5600	0.78 27.6	87.3 0.351	39	-20 to +60	30000/60°C (53000/40°C)		
▶▶ 9A0624S401			0.08	1.92	4600	0.65 23.0	56.8 0.228	33				
▶▶ 9A0624H401		6 to 13.8	0.06	1.44	3800	0.53 18.7	40.2 0.161	28			-20 to +70	40000/60°C (70000/40°C)
▶▶ 9A0624F401			0.05	1.2	3200	0.44 15.5	29.4 0.118	24				
▶▶ 9A0624M401			0.04	0.96	2600	0.36 12.7	19.6 0.079	20				

Note 1: Sensor and control options are available for selection. Refer to the table on pp. 623 to 624.

Note 2: The ▶▶ mark indicates Short LeadTime Service applicable models. See p. 654 for details.

Airflow - Static Pressure Characteristics

9A0612G401 With pulse sensor

Operating voltage range

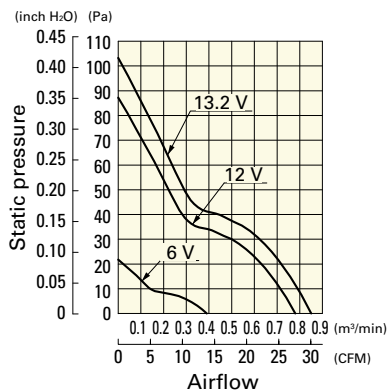

9A0612S401 With pulse sensor

Operating voltage range

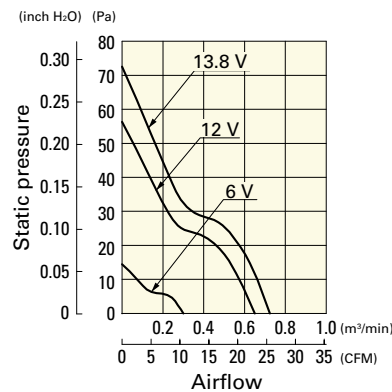

9A0612H401 With pulse sensor

Operating voltage range

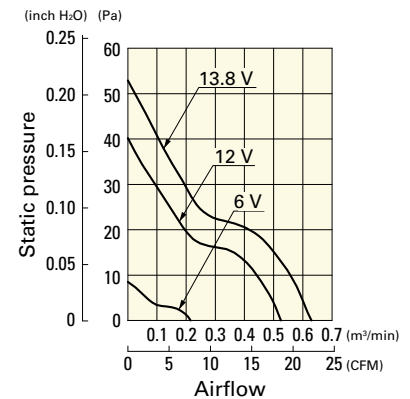

Airflow - Static Pressure Characteristics

9A0612F401 With pulse sensor

Operating voltage range

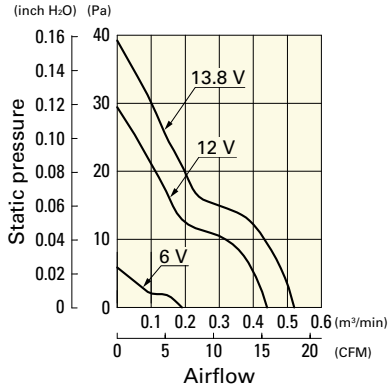

9A0612M401 With pulse sensor

Operating voltage range

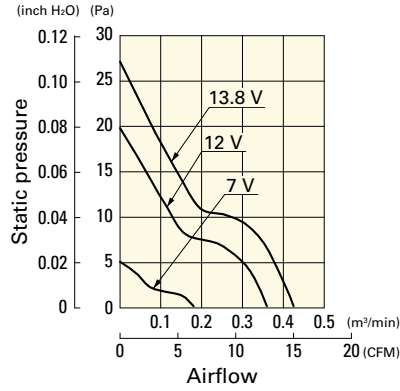

9A0624G401 With pulse sensor

Operating voltage range

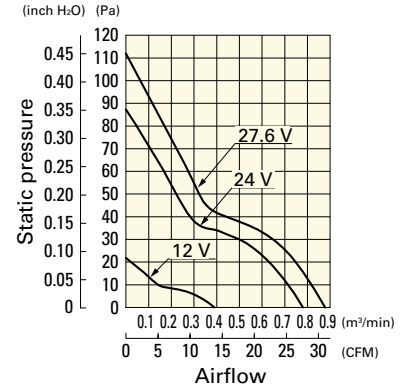

9A0624S401 With pulse sensor

Operating voltage range

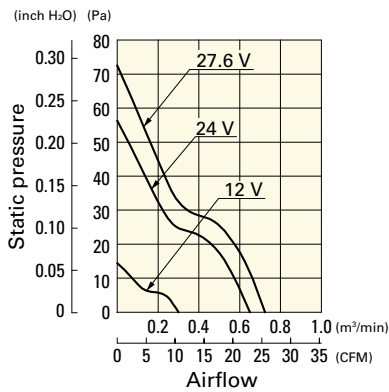

9A0624H401 With pulse sensor

Operating voltage range

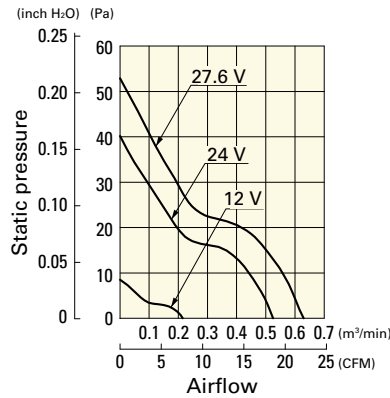

9A0624F401 With pulse sensor

Operating voltage range

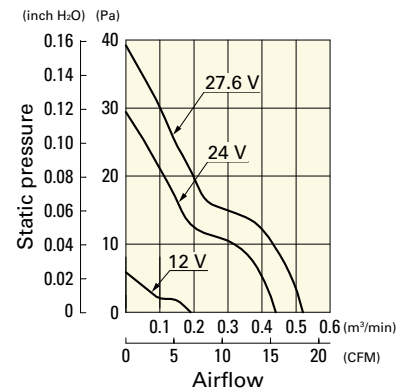

9A0624M401 With pulse sensor

Operating voltage range

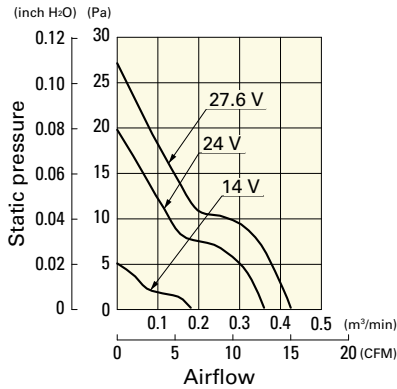

Dimensions (unit: mm) (With ribs)

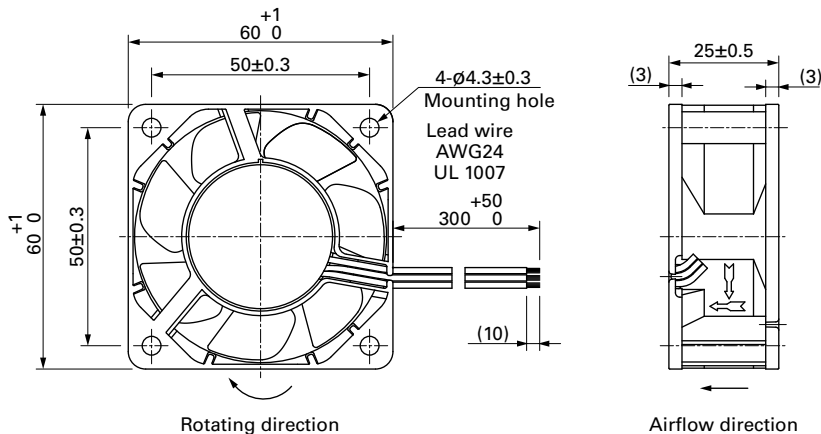

Reference Dimensions of Mounting Holes and Vent Opening (unit: mm)

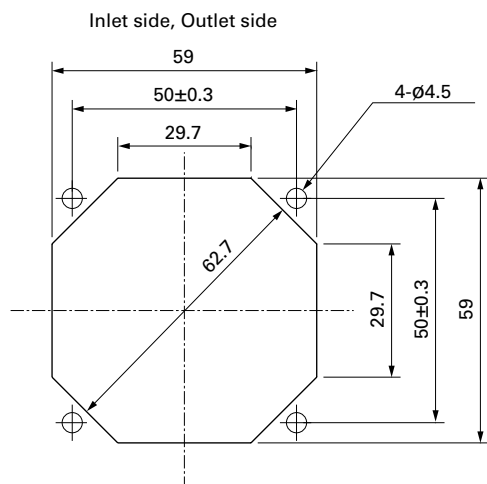

Options

Finger guards

page: p. 584

Model no.: 109-139E, 109-139H

Resin finger guards

page: p. 591

Model no.: 109-1003G

Resin filter kits

page: p. 592

Model no.: 109-1003F13 (13PPI), 109-1003F20 (20PPI),
109-1003F30 (30PPI), 109-1003F40 (40PPI)