

## CPDQC5V0R-HF / CPDUC5V0R-HF

RoHS Device

Halogen Free

### Table

Part Number	Package
CPDQC5V0R-HF	0402C/SOD-923F
CPDUC5V0R-HF	0603C/SOD-523F

### Features

- Bi-directional ESD protection.
- IEC 61000-4-2 (ESD) ; ±30KV(contact).
- Surface mount package.
- Operating voltage: 5V
- Low clamping voltage.
- Low leakage current.
- High surge current.



### Mechanical data

- Terminals: Matte tin plated, solderable per MIL-STD-750, method 2026.
- Marking Code: E5R
- Mounting position: Any
- Weight:
  - 0402C: 0.001 grams(approx.).
  - 0603C: 0.003 grams(approx.).

### Circuit Diagram

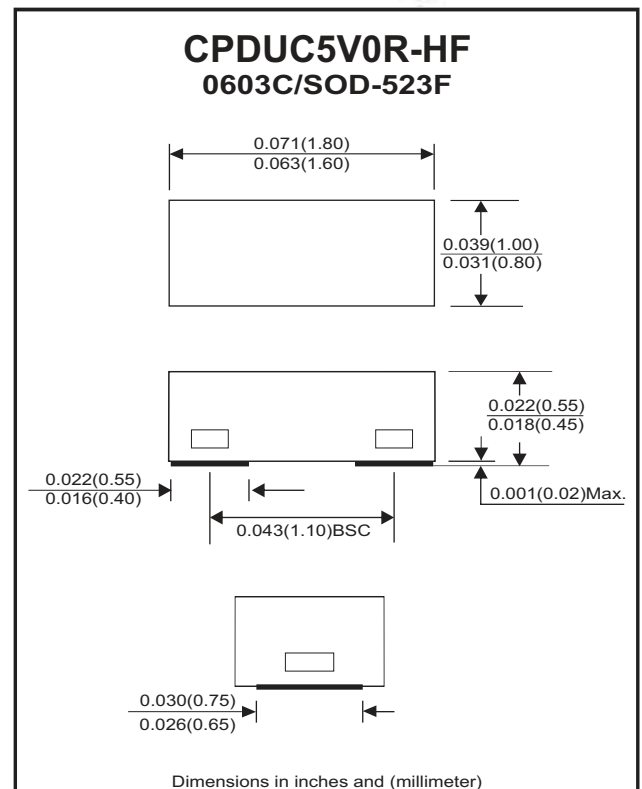
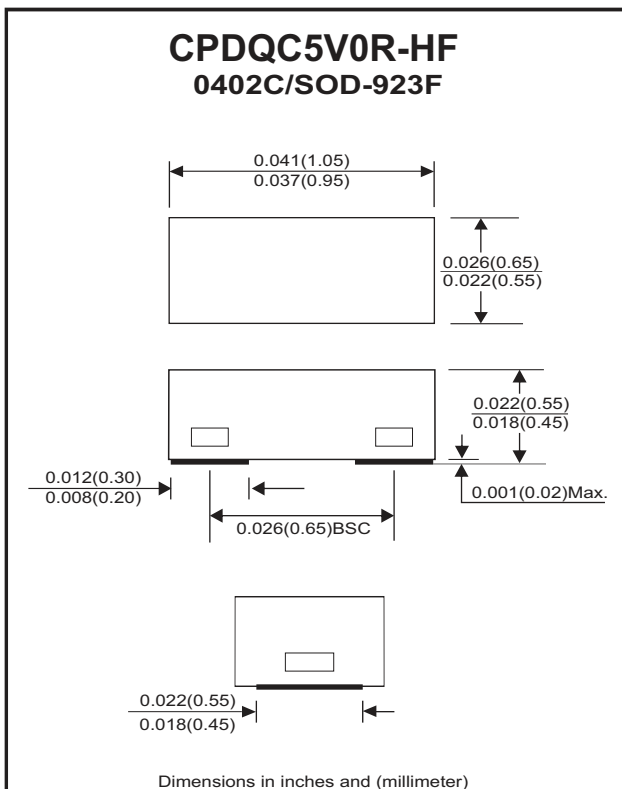

## Electrical Characteristics (at TA=25°C unless otherwise noted)

Parameter	Conditions	Symbol	Min	Typ	Max	Unit
Reverse stand-Off voltage		$V_{RWM}$	-	-	5	V
Diode breakdown voltage	$I_R = 1mA$	$V_{BD}$	5.6	-	9.4	V
Reverse leakage current	$V_R = 5V$	$I_L$	-	5	90	nA
Junction capacitance	$V_R = 0V, f = 1MHz$	$C_T$	-	24	30	pF
ESD capability	IEC 61000-4-2(air) IEC 61000-4-2(contact)	ESD	-	-	±30	kV
Clamping Voltage	$I_{PP} = 1A, t_p = 8/20\mu s$	$V_c$	-	-	8	V
	$I_{PP} = 11A, t_p = 8/20\mu s$	$V_c$	-	-	12	V
Operation temperature		$T_j$	-40	-	+150	°C
Storage temperature		$T_{STG}$	-40	-	+150	°C

## Rating and Characteristic Curves

Fig.1 - Reverse Characteristics

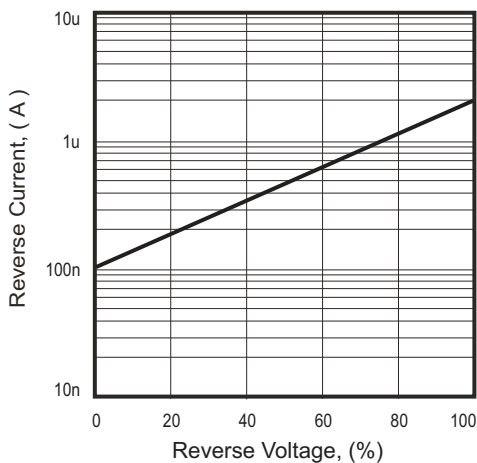

Fig.2 - Typical Capacitance Between Terminals Characteristics

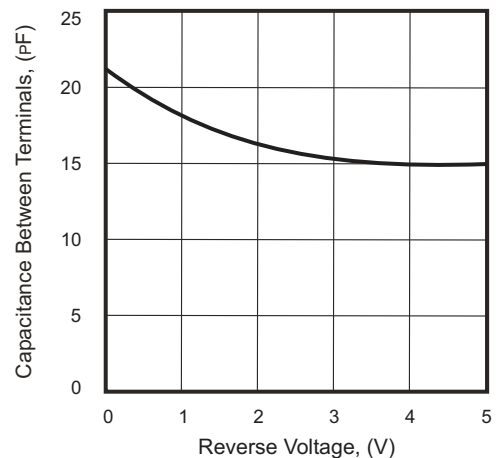

Fig.3 - Clamping Voltage vs. Peak Pulse Current

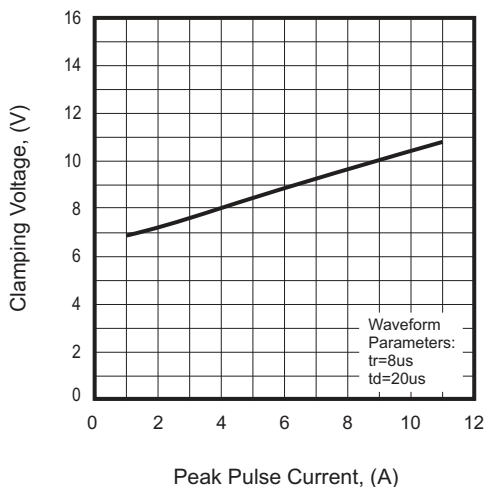
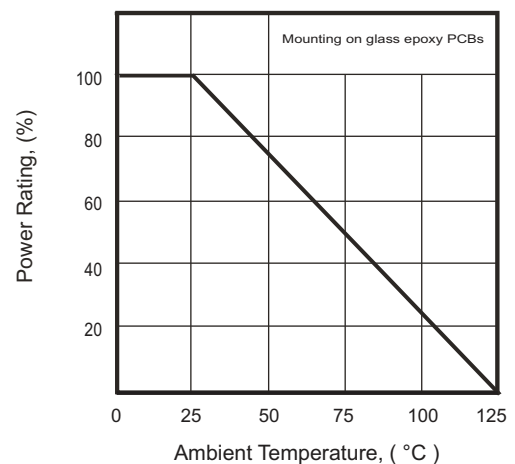
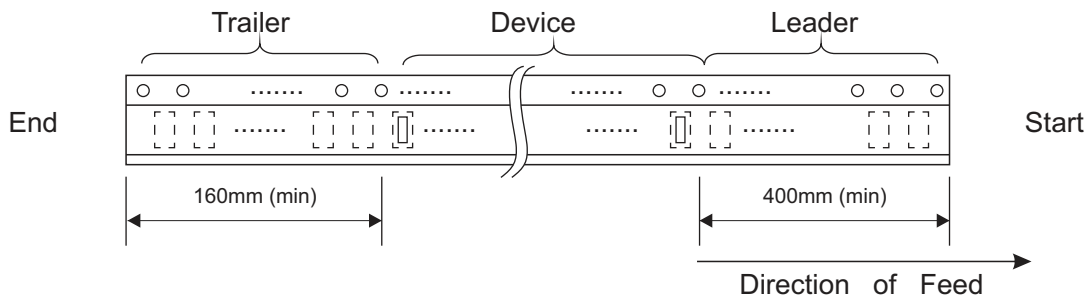
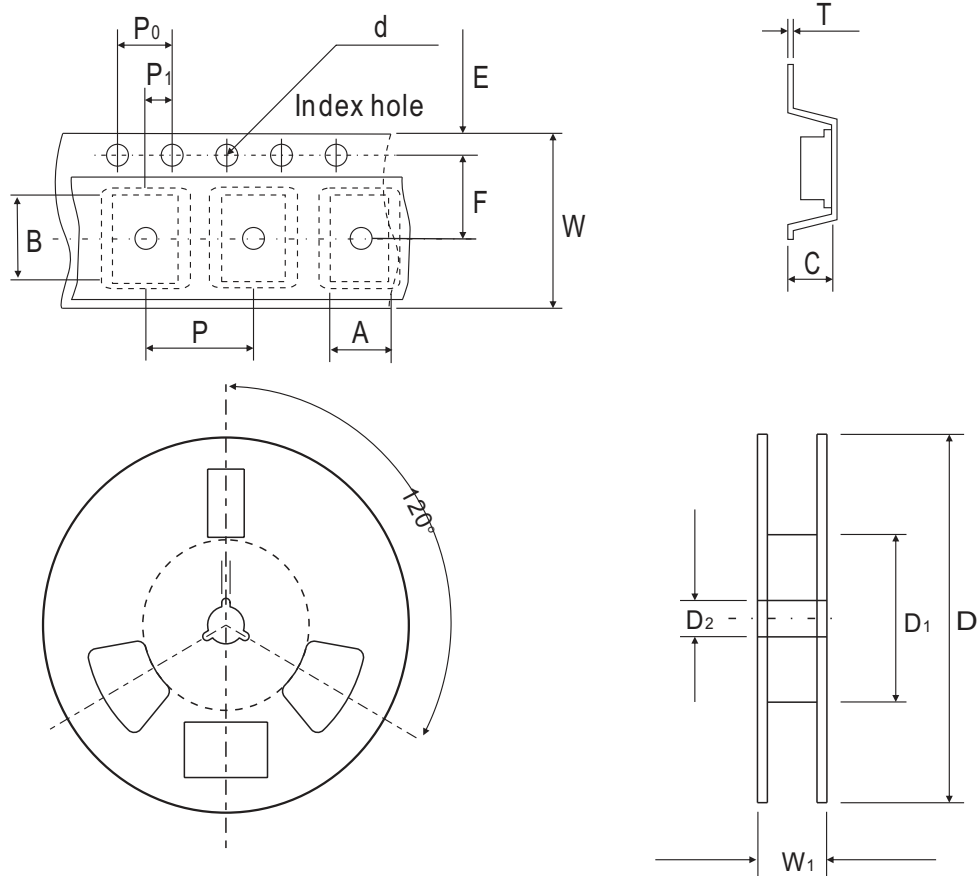

Fig. 4 - Power Rating Derating Curve



## 0402C/SOD-923F Reel Taping Specification



0402C (SOD-923F)	SYMBOL	A	B	C	d	D	D <sub>1</sub>	D <sub>2</sub>
	(mm)	0.75 ± 0.05	1.17 ± 0.05	0.65 ± 0.05	1.50 + 0.10 - 0	178.00 ± 1.00	60.00 ± 0.50	13.50 ± 0.20
	(inch)	0.030 ± 0.002	0.046 ± 0.002	0.026 ± 0.002	0.059 + 0.004 - 0	7.008 ± 0.039	2.362 ± 0.020	0.531 ± 0.008

0402C (SOD-923F)	SYMBOL	E	F	P	P <sub>0</sub>	P <sub>1</sub>	T	W	W <sub>1</sub>
	(mm)	1.75 ± 0.10	3.50 ± 0.10	4.00 ± 0.10	4.00 ± 0.10	2.00 ± 0.10	0.20 + 0.02 - 0.05	8.00 ± 0.20	12.00 + 0.50 - 0
	(inch)	0.069 ± 0.004	0.138 ± 0.004	0.157 ± 0.004	0.157 ± 0.004	0.079 ± 0.004	0.008 + 0.001 - 0.002	0.315 ± 0.008	0.472 + 0.020 - 0



## Marking Code

Part Number	Marking Code
CPDQC5V0R-HF	E5R
CPDUC5V0R-HF	E5R



## Suggested PAD Layout

SIZE	0402C/SOD-923F	
	(mm)	(inch)
A	0.70	0.028
B	0.40	0.016
C	0.70	0.028
D	1.10	0.043
E	0.30	0.012

## Suggested PAD Layout

SIZE	0603C/SOD-523F	
	(mm)	(inch)
A	1.10	0.043
B	0.70	0.028
C	1.00	0.039
D	1.80	0.071
E	0.40	0.016

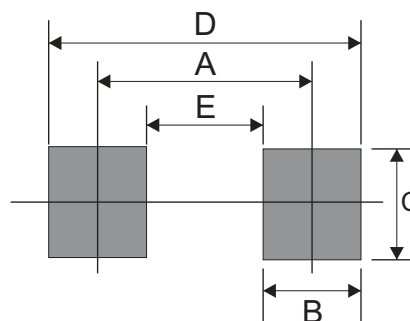
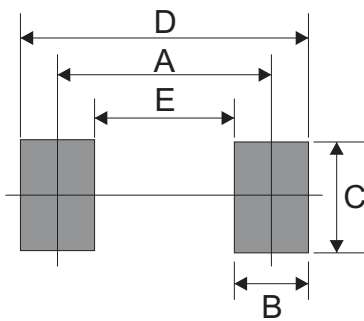

## Standard Packaging

Case Type	Qty Per Reel	Reel Size
	(Pcs)	(inch)
0402C/SOD-923F	5,000	7
0603C/SOD-523F	4,000	7