

# N-Channel, Logic Level Enhancement Mode Field Effect Transistor

## NDB5060L

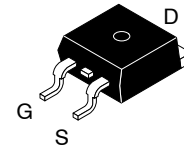

D2PAK-3  
(TO-263, 3-LEAD)  
CASE 418AJ

### General Description

These logic level N-Channel enhancement mode power field effect transistors are produced using onsemi's proprietary, high cell density, DMOS technology. This very high density process has been especially tailored to minimize on-state resistance, provide superior switching performance, and withstand high energy pulses in the avalanche and commutation modes. These devices are particularly suited for low voltage applications such as automotive, DC-DC converters, PWM motor controls, and other battery powered circuits where fast switching, low in-line power loss, and resistance to transients are needed.

### Features

- 26 A, 60 V
  - ◆  $R_{DS(ON)} = 0.05 \text{ m}\Omega @ V_{GS} = 5 \text{ V}$
  - ◆  $R_{DS(ON)} = 0.035 \text{ m}\Omega @ V_{GS} = 10 \text{ V}$
- Critical DC Electrical Parameters Specified at Elevated Temperature
- Rugged Internal Source-Drain Diode Can Eliminate the Need for an External Zener Diode Transient Suppressor
- 175°C Maximum Junction Temperature Rating
- High Density Cell Design for Extremely Low  $R_{DS(ON)}$
- D<sup>2</sup>PAK Package for Both Through Hole and Surface Mount Applications

### N-CHANNEL MOSFET

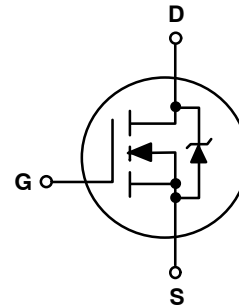

### MARKING DIAGRAM

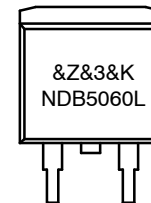

&Z = Assembly Plan Code  
&3 = 3-Digit Date Code (Year & Week)  
&K = 2-Digits Lot Run Traceability Code  
NDB5060L = Specific Device Code

### ABSOLUTE MAXIMUM RATINGS $T_C = 25^\circ\text{C}$ unless otherwise noted

Symbol	Rating	Value	Unit
$V_{DSS}$	Drain-Source Voltage	60	V
$V_{DGR}$	Drain-Gate Voltage ( $R_{GS} \leq 1 \text{ M}\Omega$ )	60	V
$V_{GSS}$	Drain-Source Voltage - Continuous - Nonrepetiti ( $t_p < 50 \mu\text{s}$ )	$\pm 16$ $\pm 25$	V
$I_D$	Drain Current - Continuous - Pulsed	26 78	A
$P_D$	Total Power Dissipation @ $T_C = 25^\circ\text{C}$ - Derate above $25^\circ\text{C}$	68 0.45	W W/ $^\circ\text{C}$
$T_J, T_{STG}$	Operating and Storage Temperature Range	-65 to 175	$^\circ\text{C}$

Stresses exceeding those listed in the Maximum Ratings table may damage the device. If any of these limits are exceeded, device functionality should not be assumed, damage may occur and reliability may be affected.

### THERMAL CHARACTERISTICS

Symbol	Rating	Value	Unit
$R_{\theta JC}$	Thermal Resistance, Junction-to-Case	2.2	$^\circ\text{C}/\text{W}$
$R_{\theta JA}$	Thermal Resistance, Junction-to-Ambient	62.5	$^\circ\text{C}/\text{W}$

### ORDERING INFORMATION

Device	Package	Shipping <sup>†</sup>
NDB5060L	D2PAK-3 (Pb-Free)	800 / Tape & Reel

<sup>†</sup>For information on tape and reel specifications, including part orientation and tape sizes, please refer to our Tape and Reel Packaging Specification Brochure, [BRD8011/D](#).

# NDB5060L

## ELECTRICAL CHARACTERISTICS (T<sub>C</sub> = 25°C unless otherwise specified)

Symbol	Parameter	Condition	Min	Typ	Max	Unit
--------	-----------	-----------	-----	-----	-----	------

### DRAIN-SOURCE AVALANCHE RATINGS (Note 1)

W <sub>DSS</sub>	Single Pulse Drain-Source Avalanche Energy	V <sub>DD</sub> = 30 V, I <sub>D</sub> = 26 A	-	-	100	mJ
I <sub>AR</sub>	Maximum Drain-Source Avalanche Current		-	-	26	A

### OFF CHARACTERISTICS

BV <sub>DSS</sub>	Drain-Source Breakdown Voltage	V <sub>GS</sub> = 0 V, I <sub>D</sub> = 250 μA	60	-	-	V
I <sub>DSS</sub>	Zero Gate Voltage Drain Current	V <sub>DS</sub> = 60 V, V <sub>GS</sub> = 0 V	-	-	250	μA
		V <sub>DS</sub> = 60 V, V <sub>GS</sub> = 0 V, T <sub>J</sub> = 125°C	-	-	1	mA
I <sub>GSSF</sub>	Gate-Body Leakage, Forward	V <sub>GS</sub> = 16 V, V <sub>DS</sub> = 0 V	-	-	100	nA
I <sub>GSSR</sub>	Gate-Body Leakage, Reverse	V <sub>GS</sub> = -16 V, V <sub>DS</sub> = 0 V	-	-	-100	nA

### ON CHARACTERISTICS (Note 1)

V <sub>GS(th)</sub>	Gate Threshold Voltage	V <sub>DS</sub> = V <sub>GS</sub> , I <sub>D</sub> = 250 μA	1	1.4	2	V
		V <sub>DS</sub> = V <sub>GS</sub> , I <sub>D</sub> = 250 μA, T <sub>J</sub> = 125°C	0.65	1	1.5	
R <sub>DS(on)</sub>	Static Drain-Source On-Resistance	V <sub>GS</sub> = 5 V, I <sub>D</sub> = 13 A	-	0.042	0.05	Ω
		V <sub>GS</sub> = 5 V, I <sub>D</sub> = 13 A, T <sub>J</sub> = 125°C	-	0.07	0.08	
		V <sub>GS</sub> = 10 V, V <sub>DS</sub> = 13 A	-	0.031	0.035	
I <sub>D(on)</sub>	On-State Drain Current	V <sub>GS</sub> = 5 V, V <sub>DS</sub> = 10 V	26	-	-	A
g <sub>FS</sub>	Forward Transconductance	V <sub>DS</sub> = 10 V, I <sub>D</sub> = 13 A	-	16	-	S

### DYNAMIC CHARACTERISTICS

C <sub>iss</sub>	Input Capacitance	V <sub>DS</sub> = 30 V, V <sub>GS</sub> = 0 V, f = 1.0 MHz	-	840	-	pF
C <sub>oss</sub>	Output Capacitance		-	230	-	pF
C <sub>rss</sub>	Reverse Transfer Capacitance		-	75	-	pF

### SWITCHING CHARACTERISTICS (Note 1)

t <sub>D(on)</sub>	Turn - On Delay Time	V <sub>DD</sub> = 30 V, I <sub>D</sub> = 26 A, V <sub>GS</sub> = 5 V, R <sub>GEN</sub> = 30 Ω, R <sub>GS</sub> = 30 Ω	-	13	20	nS
t <sub>r</sub>	Turn - On Rise Time		-	200	400	nS
t <sub>D(off)</sub>	Turn - Off Delay Time		-	45	80	nS
t <sub>f</sub>	Turn - Off Fall Time		-	102	200	nS
Q <sub>g</sub>	Total Gate Charge	V <sub>DS</sub> = 24 V, I <sub>D</sub> = 26 A, V <sub>GS</sub> = 5 V	-	17	24	nC
Q <sub>gs</sub>	Gate-Source Charge		-	4	-	nC
Q <sub>gd</sub>	Gate-Drain Charge		-	10	-	nC

### DRAIN-SOURCE DIODE CHARACTERISTICS

I <sub>S</sub>	Maximum Continuous Drain-Source Diode Forward Current		-	-	26	A
I <sub>SM</sub>	Maximum Pulsed Drain-Source Diode Forward Current		-	-	78	A
V <sub>SD</sub>	Drain-Source Diode Forward Voltage	V <sub>GS</sub> = 0 V, I <sub>S</sub> = 13 A (Note 1)	-	0.9	1.3	V
t <sub>rr</sub>	Reverse Recovery Time	V <sub>GS</sub> = 0 V, I <sub>F</sub> = 26 A, dI <sub>F</sub> /dt = 100 A/μs	-	54	120	ns
I <sub>rr</sub>	Reverse Recovery Current		-	2.1	8	A

Product parametric performance is indicated in the Electrical Characteristics for the listed test conditions, unless otherwise noted. Product performance may not be indicated by the Electrical Characteristics if operated under different conditions.

1. Pulse Test: Pulse Width ≤ 300 μs, Duty Cycle ≤ 2.0%.

TYPICAL CHARACTERISTICS

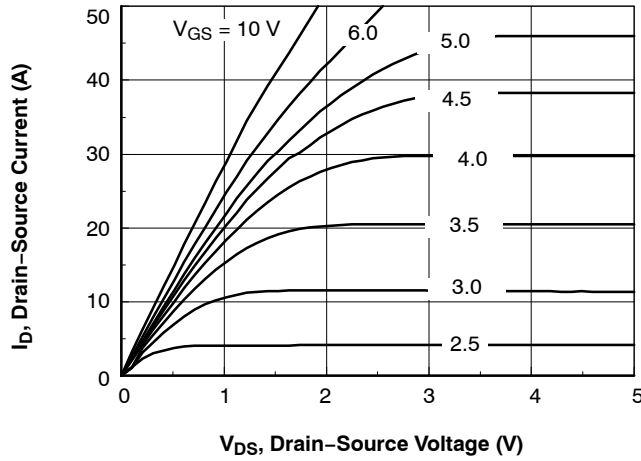

Figure 1. On-Region Characteristics

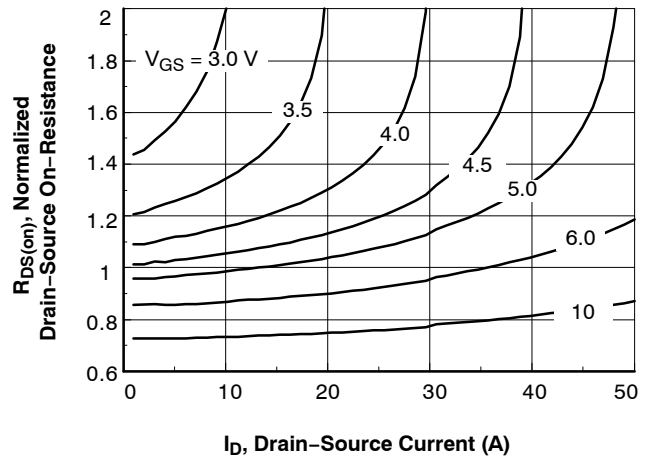

Figure 2. On-Resistance Variation with Gate Voltage and Drain Current

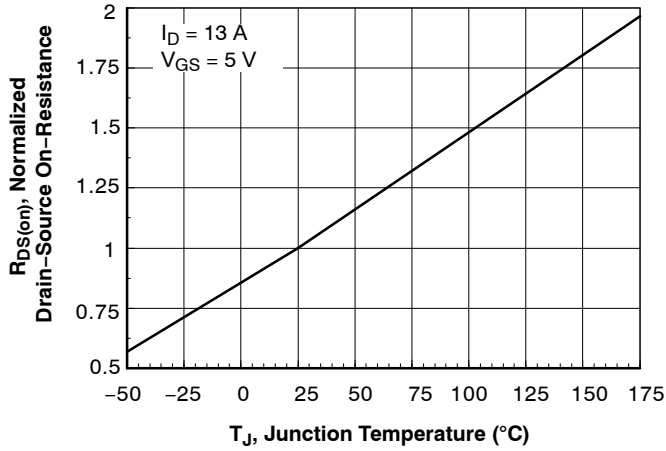

Figure 3. On-Resistance Variation with Temperature

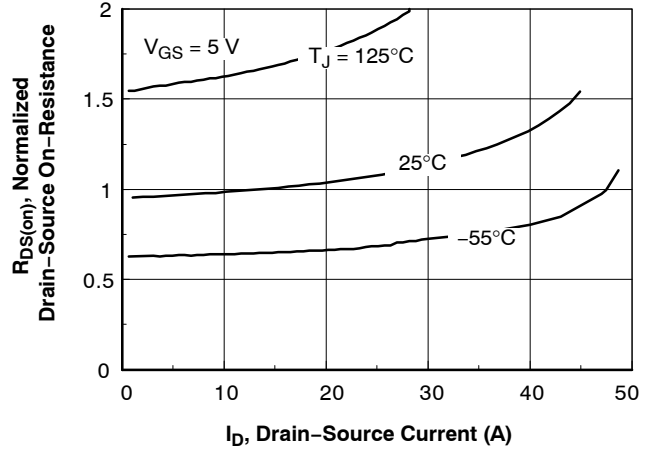

Figure 4. On-Resistance Variation with Drain Current and Temperature

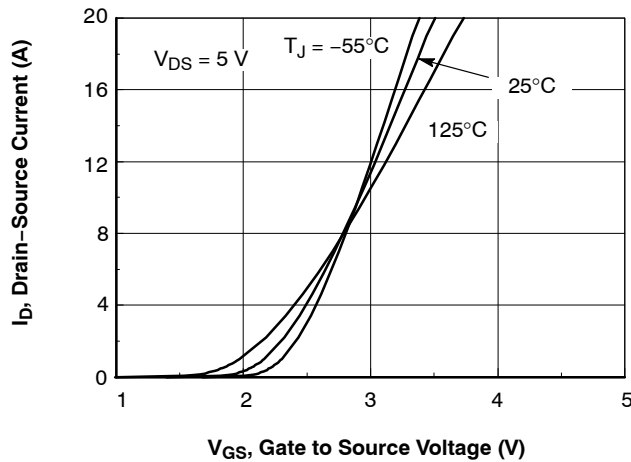

Figure 5. Transfer Characteristics

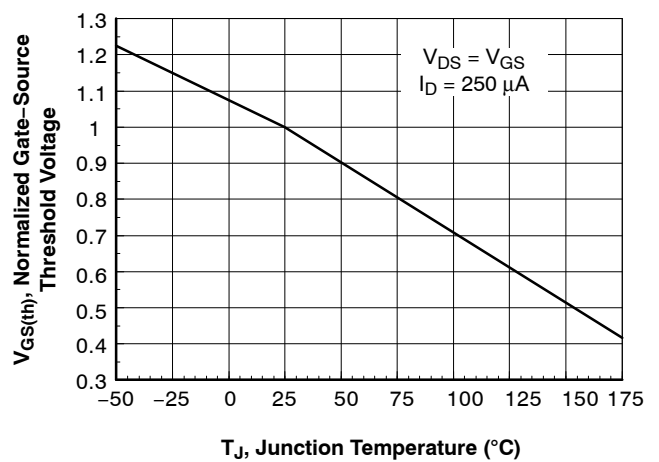

Figure 6. Gate Threshold Variation with Temperature

TYPICAL CHARACTERISTICS (Continued)

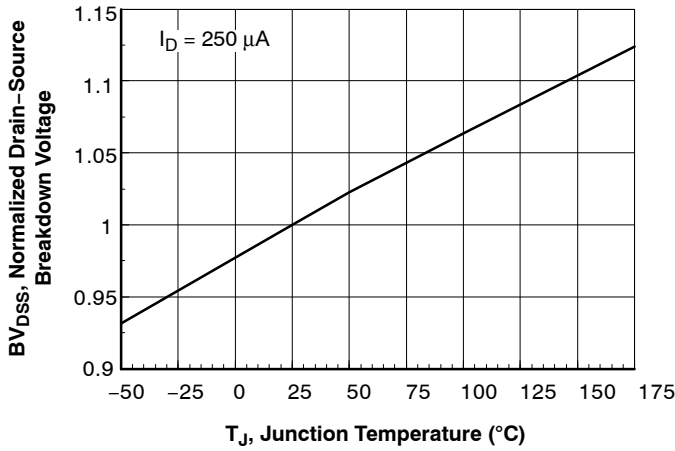

Figure 7. Breakdown Voltage Variation with Temperature

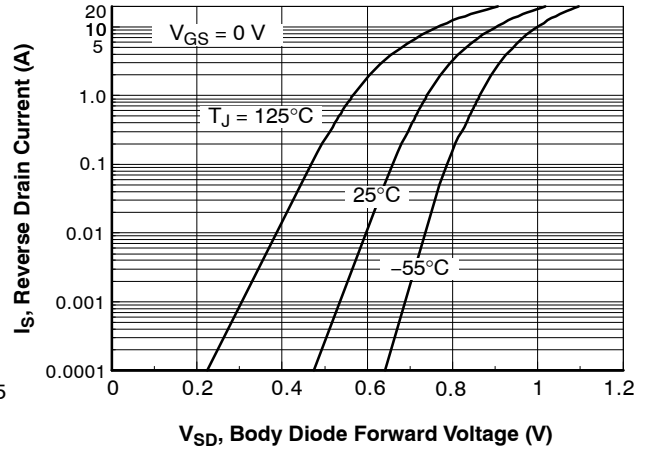

Figure 8. Body Diode Forward Voltage Variation with Current and Temperature

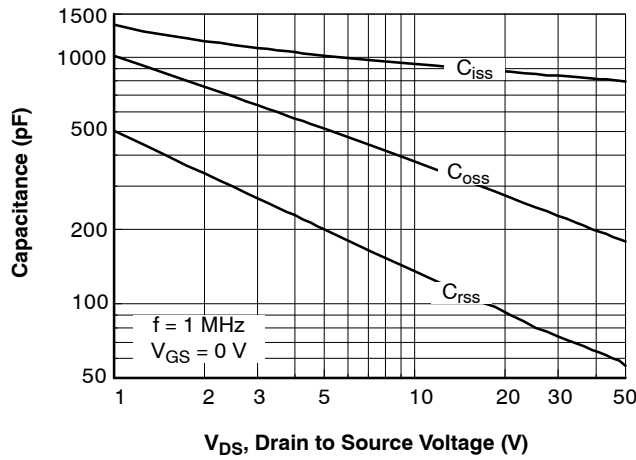

Figure 9. Capacitance Characteristics

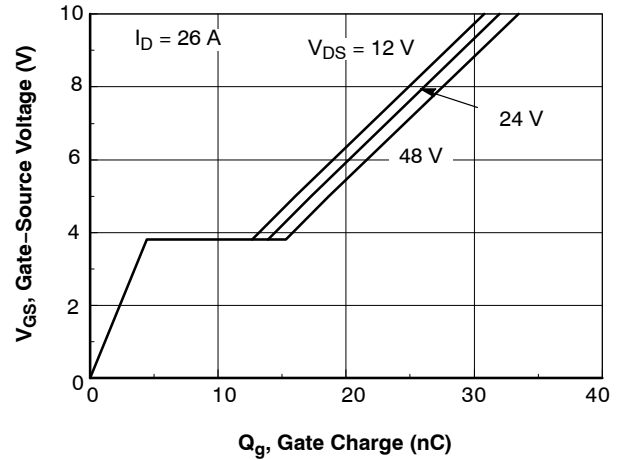

Figure 10. Gate Charge Characteristics

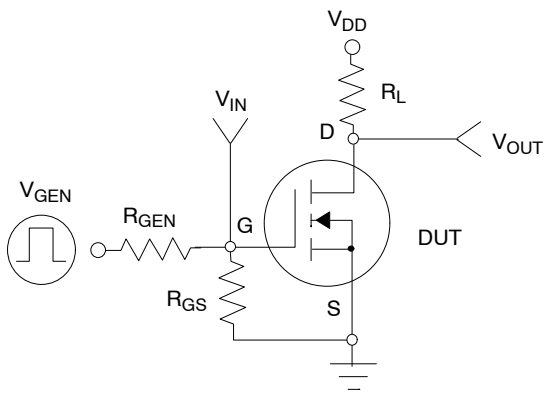

Figure 11. Switching Test Circuit

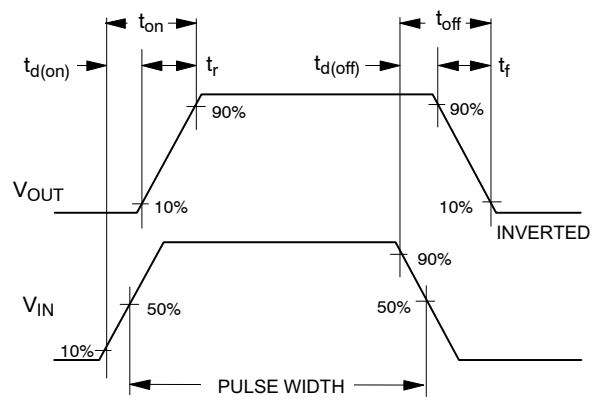

Figure 12. Switching Waveforms

TYPICAL CHARACTERISTICS (Continued)

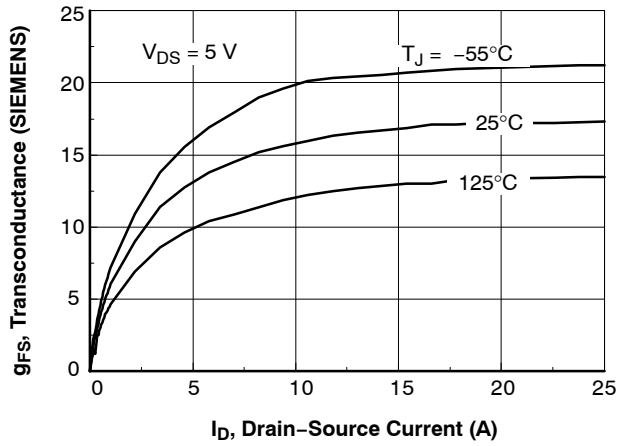

Figure 13. Transconductance Variation with Drain Current and Temperature

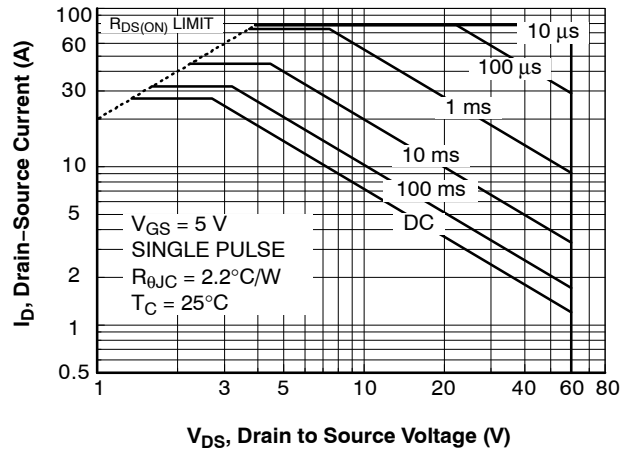

Figure 14. Maximum Safe Operating Area

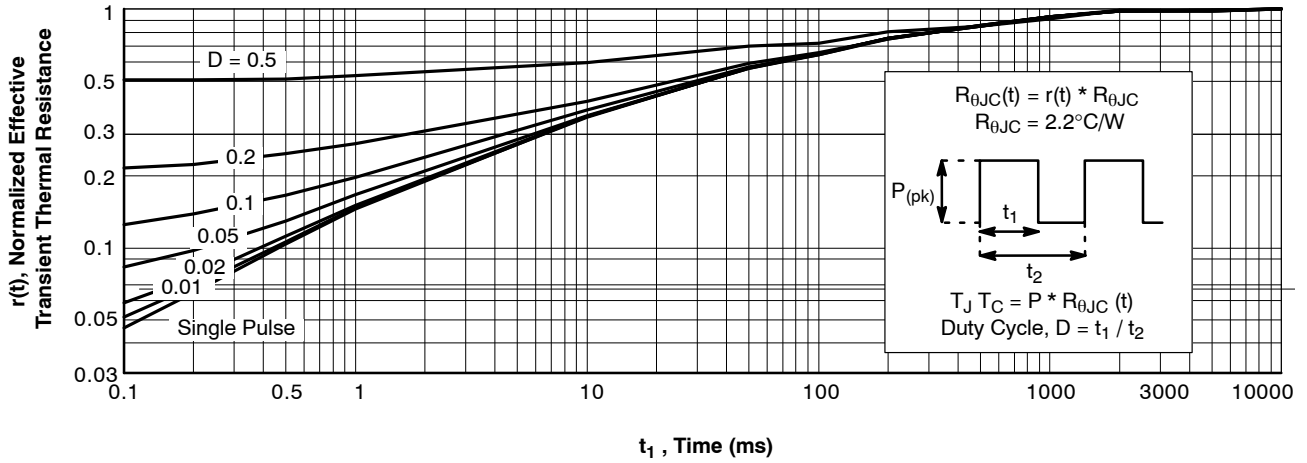
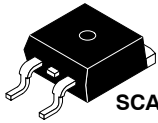

Figure 15. Transient Thermal Response Curve

# MECHANICAL CASE OUTLINE

## PACKAGE DIMENSIONS

ON Semiconductor®



SCALE 1:1

### D<sup>2</sup>PAK-3 (TO-263, 3-LEAD)

#### CASE 418AJ

#### ISSUE F

DATE 11 MAR 2021

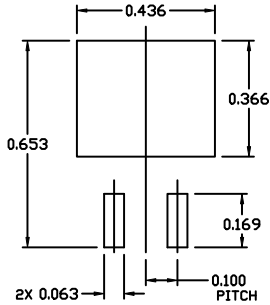

#### RECOMMENDED MOUNTING FOOTPRINT

For additional information on our Pb-free strategy and soldering details, please download the ON Semiconductor Soldering and Mounting Techniques Reference Manual, SOLDERRM/D.

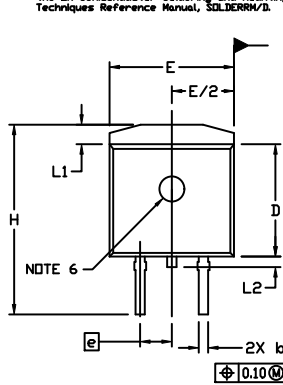

#### NOTES:

- DIMENSIONING AND TOLERANCING PER ASME Y14.5M, 2009.
- CONTROLLING DIMENSION: INCHES
- CHAMFER OPTIONAL.
- DIMENSIONS D AND E DO NOT INCLUDE MOLD FLASH. MOLD FLASH SHALL NOT EXCEED 0.005 PER SIDE. THESE DIMENSIONS ARE MEASURED AT THE OUTERMOST EXTREMES OF THE PLASTIC BODY AT DATUM H.
- THERMAL PAD CONTOUR IS OPTIONAL WITHIN DIMENSIONS E, L1, D1, AND E1.
- OPTIONAL MOLD FEATURE.
- ①, ② ... OPTIONAL CONSTRUCTION FEATURE CALL OUTS.

DIM	INCHES		MILLIMETERS	
	MIN.	MAX.	MIN.	MAX.
A	0.160	0.190	4.06	4.83
A1	0.000	0.010	0.00	0.25
b	0.020	0.039	0.51	0.99
c	0.012	0.029	0.30	0.74
c2	0.045	0.065	1.14	1.65
D	0.330	0.380	8.38	9.65
D1	0.260	---	6.60	---
E	0.380	0.420	9.65	10.67
E1	0.245	---	6.22	---
e	0.100	BSC	2.54	BSC
H	0.575	0.625	14.60	15.88
L	0.070	0.110	1.78	2.79
L1	---	0.066	---	1.68
L2	---	0.070	---	1.78
L3	0.010	BSC	0.25	BSC
M	0*	8*	0*	8*

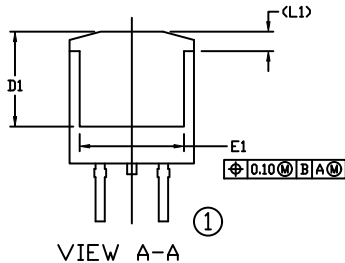
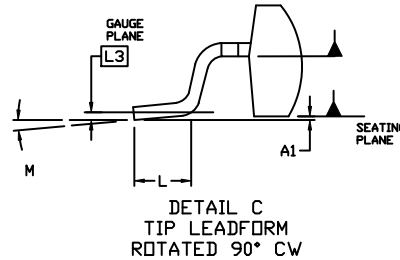
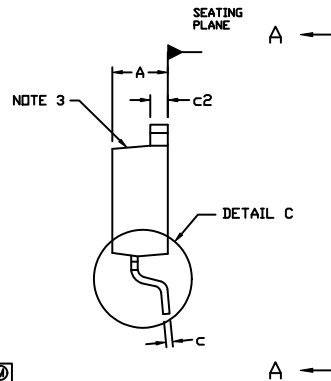

VIEW A-A

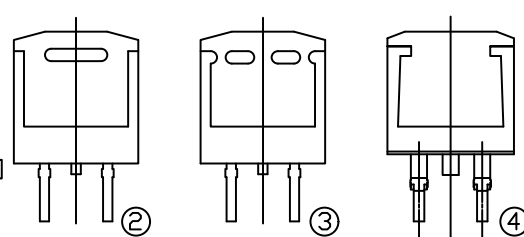

VIEW A-A  
OPTIONAL CONSTRUCTIONS

#### GENERIC MARKING DIAGRAMS\*

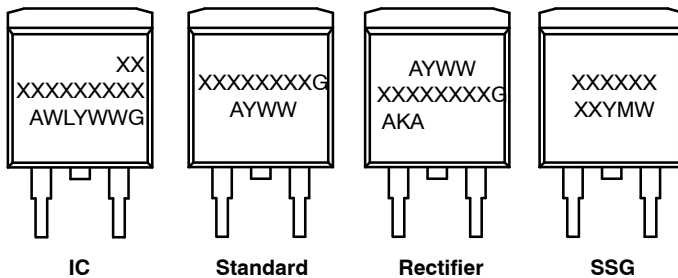

IC

Standard

Rectifier

SSG

- XXXXXX = Specific Device Code
- A = Assembly Location
- WL = Wafer Lot
- Y = Year
- WW = Work Week
- W = Week Code (SSG)
- M = Month Code (SSG)
- G = Pb-Free Package
- AKA = Polarity Indicator

\*This information is generic. Please refer to device data sheet for actual part marking. Pb-free indicator, "G" or microdot "▪", may or may not be present. Some products may not follow the Generic Marking.

DOCUMENT NUMBER:	98AON56370E	Electronic versions are uncontrolled except when accessed directly from the Document Repository. Printed versions are uncontrolled except when stamped "CONTROLLED COPY" in red.
DESCRIPTION:	D <sup>2</sup> PAK-3 (TO-263, 3-LEAD)	PAGE 1 OF 1

ON Semiconductor and ON are trademarks of Semiconductor Components Industries, LLC dba ON Semiconductor or its subsidiaries in the United States and/or other countries. ON Semiconductor reserves the right to make changes without further notice to any products herein. ON Semiconductor makes no warranty, representation or guarantee regarding the suitability of its products for any particular purpose, nor does ON Semiconductor assume any liability arising out of the application or use of any product or circuit, and specifically disclaims any and all liability, including without limitation special, consequential or incidental damages. ON Semiconductor does not convey any license under its patent rights nor the rights of others.

**onsemi**, **Onsemi**, and other names, marks, and brands are registered and/or common law trademarks of Semiconductor Components Industries, LLC dba "**onsemi**" or its affiliates and/or subsidiaries in the United States and/or other countries. **onsemi** owns the rights to a number of patents, trademarks, copyrights, trade secrets, and other intellectual property. A listing of **onsemi**'s product/patent coverage may be accessed at [www.onsemi.com/site/pdf/Patent-Marking.pdf](http://www.onsemi.com/site/pdf/Patent-Marking.pdf). **onsemi** reserves the right to make changes at any time to any products or information herein, without notice. The information herein is provided "as-is" and **onsemi** makes no warranty, representation or guarantee regarding the accuracy of the information, product features, availability, functionality, or suitability of its products for any particular purpose, nor does **onsemi** assume any liability arising out of the application or use of any product or circuit, and specifically disclaims any and all liability, including without limitation special, consequential or incidental damages. Buyer is responsible for its products and applications using **onsemi** products, including compliance with all laws, regulations and safety requirements or standards, regardless of any support or applications information provided by **onsemi**. "Typical" parameters which may be provided in **onsemi** data sheets and/or specifications can and do vary in different applications and actual performance may vary over time. All operating parameters, including "Typicals" must be validated for each customer application by customer's technical experts. **onsemi** does not convey any license under any of its intellectual property rights nor the rights of others. **onsemi** products are not designed, intended, or authorized for use as a critical component in life support systems or any FDA Class 3 medical devices or medical devices with a same or similar classification in a foreign jurisdiction or any devices intended for implantation in the human body. Should Buyer purchase or use **onsemi** products for any such unintended or unauthorized application, Buyer shall indemnify and hold **onsemi** and its officers, employees, subsidiaries, affiliates, and distributors harmless against all claims, costs, damages, and expenses, and reasonable attorney fees arising out of, directly or indirectly, any claim of personal injury or death associated with such unintended or unauthorized use, even if such claim alleges that **onsemi** was negligent regarding the design or manufacture of the part. **onsemi** is an Equal Opportunity/Affirmative Action Employer. This literature is subject to all applicable copyright laws and is not for resale in any manner.

## ADDITIONAL INFORMATION

### TECHNICAL PUBLICATIONS:

Technical Library: [www.onsemi.com/design/resources/technical-documentation](http://www.onsemi.com/design/resources/technical-documentation)  
onsemi Website: [www.onsemi.com](http://www.onsemi.com)

### ONLINE SUPPORT: [www.onsemi.com/support](http://www.onsemi.com/support)

For additional information, please contact your local Sales Representative at [www.onsemi.com/support/sales](http://www.onsemi.com/support/sales)