

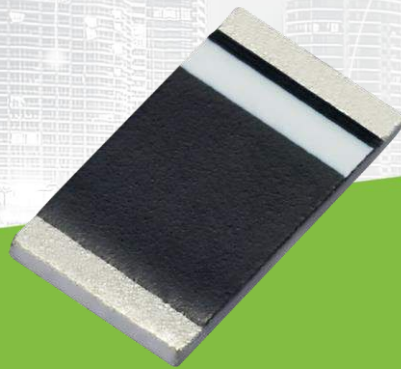

# TAOGLAS®



# Datasheet

**ILA.08 868MHz 5\*3\*0.5mm -0.5dBi Ceramic Loop Antenna**

**Part No:**  
ILA.08

**Description:**

868MHz Embedded Ceramic Loop Antenna for ISM/Lora/LPWAN/Sigfox

**Features:**

High Efficiency  
Omnidirectional  
Low profile  
Tiny Size  
Dims: 5.0\*3.0\*0.5mm  
Surface-Mount  
RoHS & REACH Compliant

1. Introduction	3
2. Specifications	4
3. Antenna Characteristics	5
4. Radiation Patterns	7
5. Mechanical Drawing – Antenna	9
6. Antenna Integration Guide	11
7. Mechanical Drawing – Evaluation Board	18
8. Soldering Conditions	19
9. Packaging	20
Changelog	21

Taoglas makes no warranties based on the accuracy or completeness of the contents of this document and reserves the right to make changes to specifications and product descriptions at any time without notice. Taoglas reserves all rights to this document and the information contained herein. Reproduction, use or disclosure to third parties without express permission is strictly prohibited.



## 1. Introduction

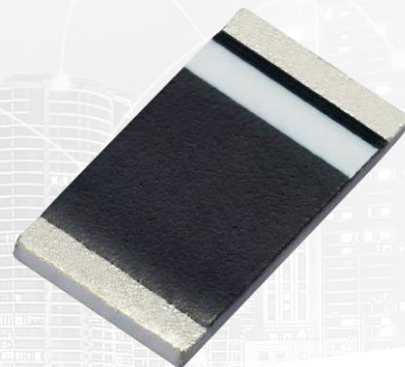

The ILA.08 is a new 868MHz ISM band embedded ceramic loop antenna from Taoglas featuring a strong efficiency of 45% at the center of the band. It is the perfect solution for the growing amount of devices using the 868MHz band, such as Sigfox or LoRa applications in Europe, or in metering applications.

This antenna works the best when placed at the center of the board edge. The ILA.08 antenna, at 5\*3\*0.5 mm, is low profile and would be suitable for devices with space constraints. The ILA.08 is delivered on tape and reel and now allows M2M customers to use an omnidirectional SMT antenna. The omnidirectional radiation characteristics allow for excellent performance regardless of device orientation. This is especially useful for devices that are not fixed in one particular spot during use. When there is little PCB space available for antenna placement, but high performance is required, the ILA.08 is the ideal choice.

The antenna is manufactured in a TS16949 first tier automotive approved facility and has passed the most stringent reliability testing. Since it is SMD, it is much easier to integrate and more reliable in high volume production compared to helical antennas which are cumbersome to install and subject to variability due to the need for manual assembly.

This antenna can be mounted with no performance degradation in either orientation as long as the antenna is soldered correctly via Surface mounting. Please see the integration instructions section for further detail regarding the optimum way to integrate this antenna into your device.

For further optimization to customer-specific device environments and for support to integrate and test this antennas performance in your device, contact your regional Taoglas Customer Services Team.

### Applications:

Sigfox, Lora, LPWAN, Automated Meter Reading (AMR), Radio Frequency Identification (RFID), Remote Monitoring, Healthcare, Sensing, Alarm Systems, Handheld Devices

## 2. Specifications

Antenna			
Frequency (MHz)	863	868	870
Efficiency (%)			
80 x 40 mm Ground Plane	42.57	46.47	44.57
Peak Gain (dBi)			
80 x 40 mm Ground Plane	-0.91 dBi	-0.51 dBi	-0.72 dBi
Max Return Loss (dB)	-10 dB		
Impedance ( $\Omega$ )	50 $\Omega$		
Polarization	Linear		
Input Power(W)	10		
Mechanical			
Dimensions (mm)	5.0 x 3.0 x 0.5		
Ground plane (mm)	80 x 40		
Weight (g)	0.02		
Environmental			
Temperature Range	-40°C to 85°C		
Storage Temperature	-40°C to 85°C		
Humidity	20% to 70%		
Moisture Sensitivity Level	3 (168 Hours)		

### 3. Antenna Characteristics

#### 3.1 Return Loss

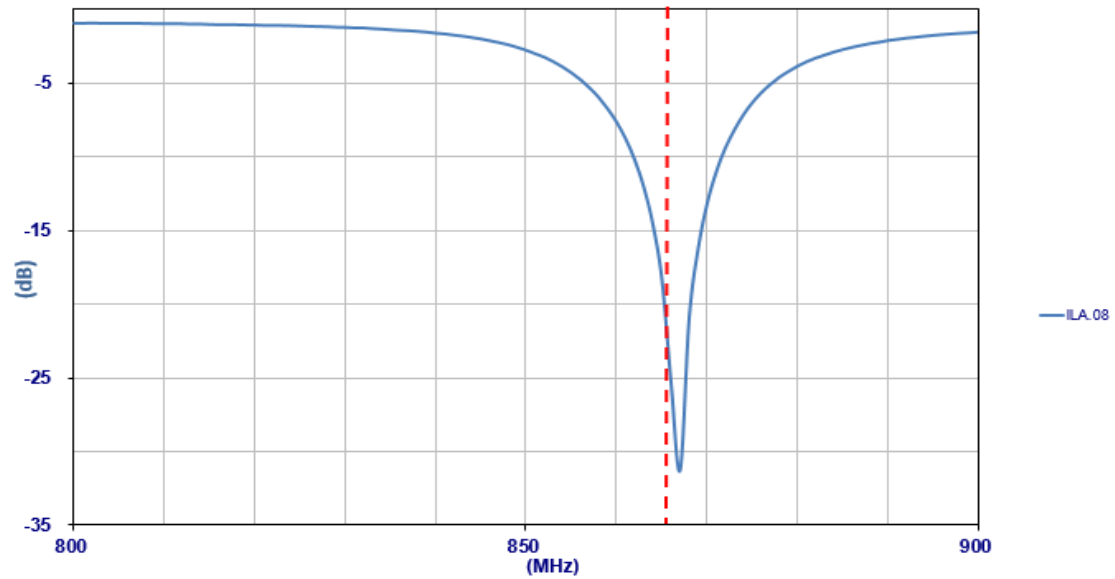

#### 3.2 Efficiency

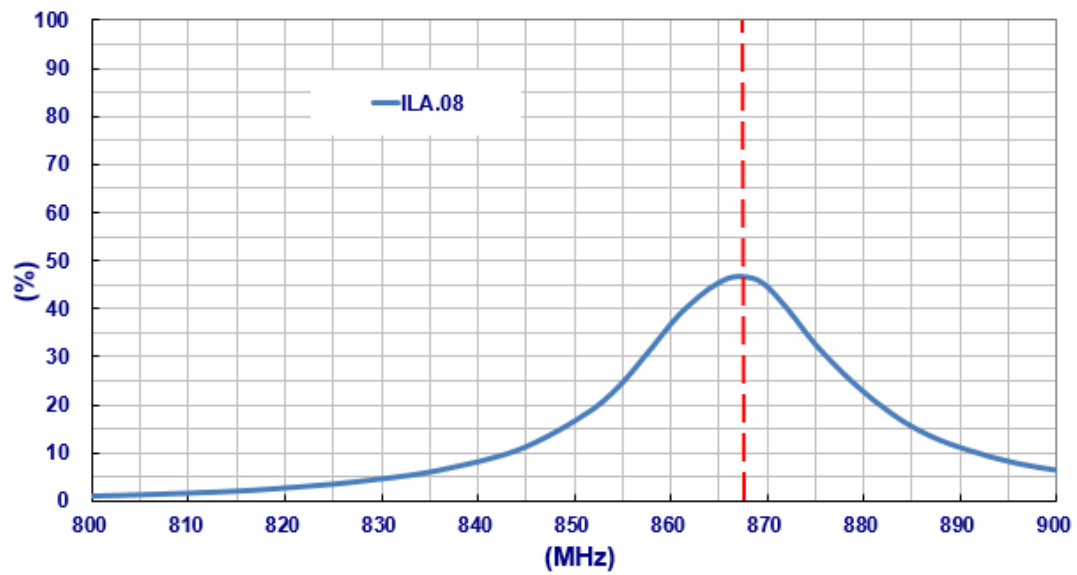

3.3 Average Gain

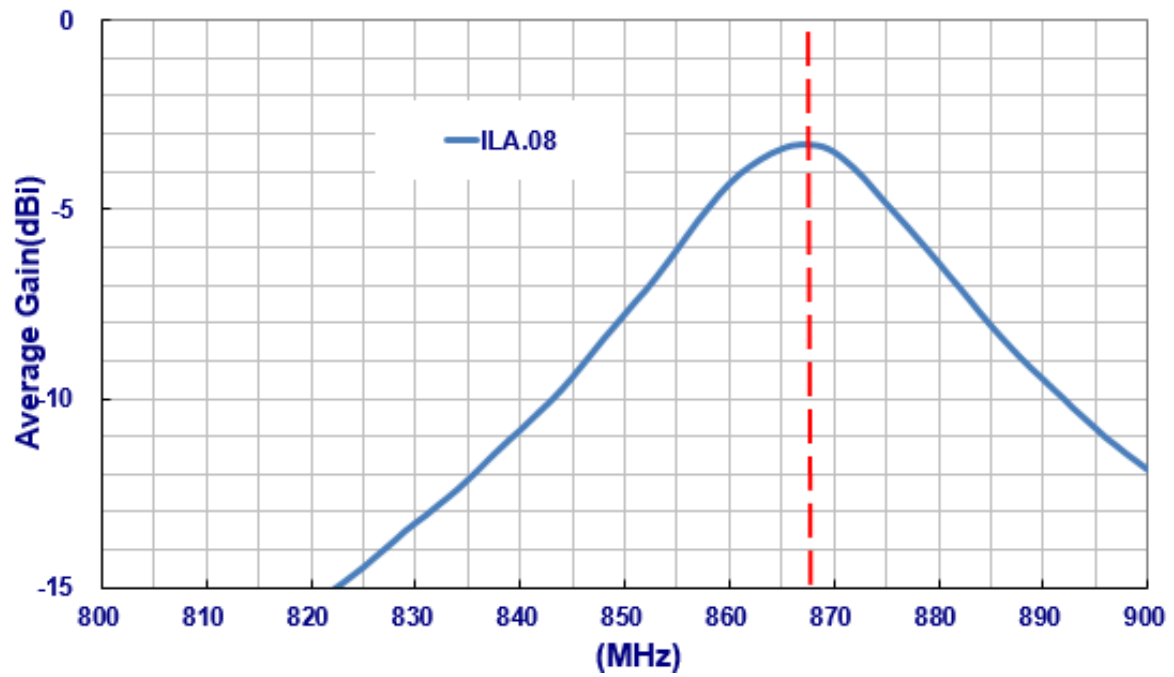

3.4 Peak Gain

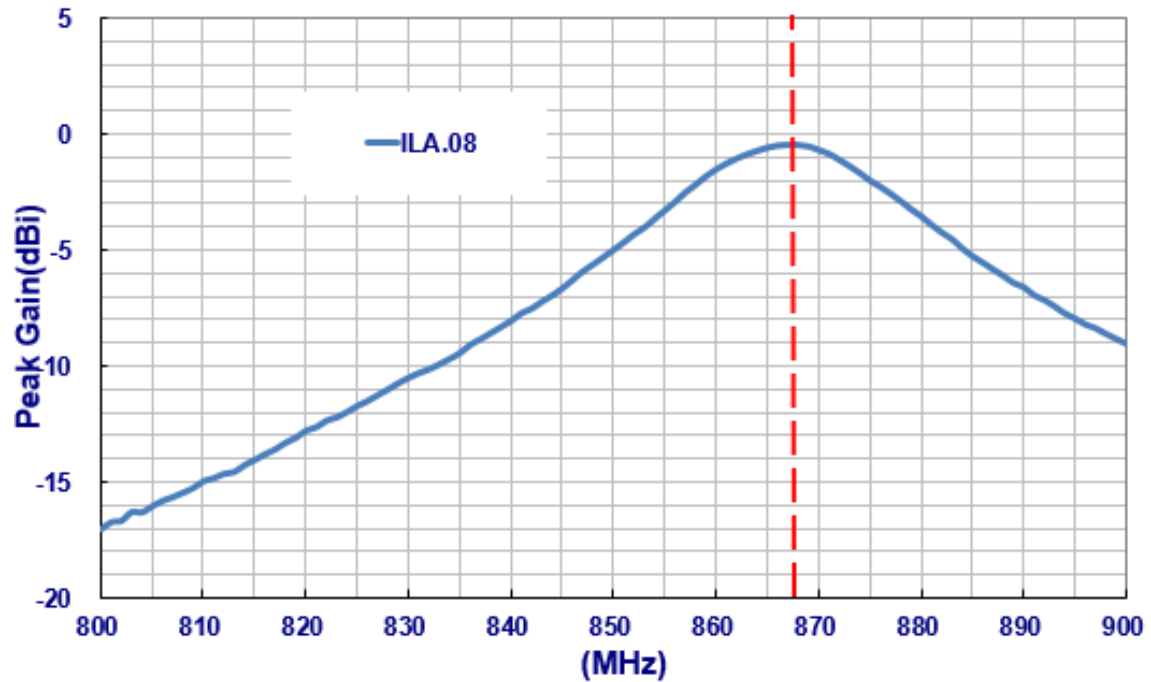

## 4. Radiation Patterns

### 4.1 Test Setup – Antenna on Evaluation Board



## 4.2 2D Radiation Pattern

868 MHz

XY Plane

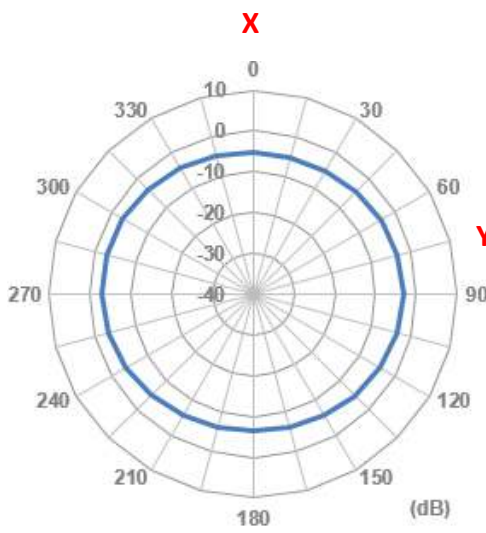

XZ Plane

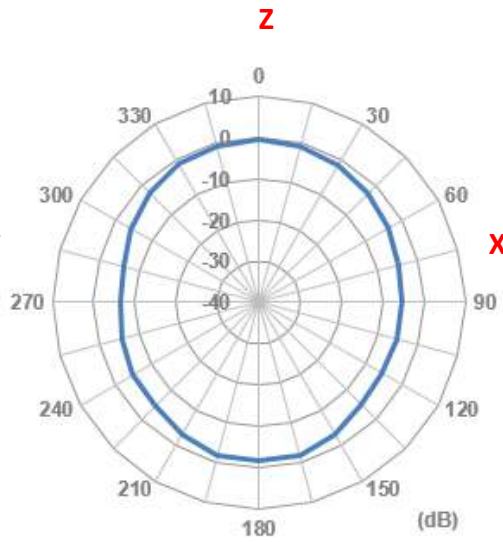

YZ Plane

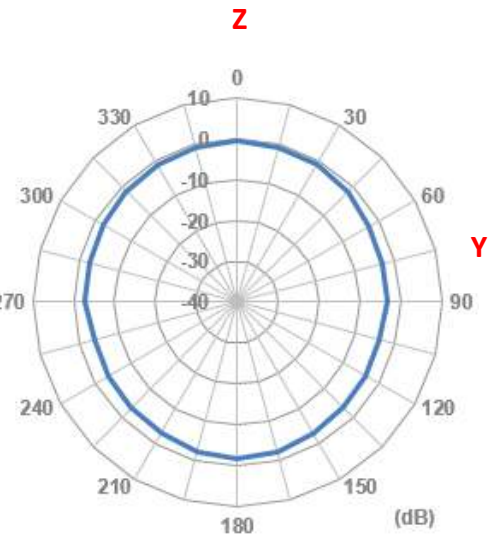

## 4.3 3D Radiation Pattern

868 MHz

Azimuth = 119.3  
Elevation = -34.9  
Roll = -45.9

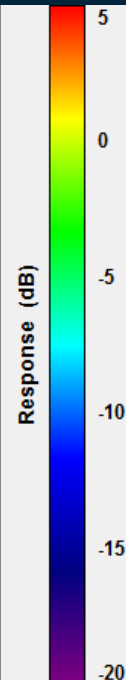
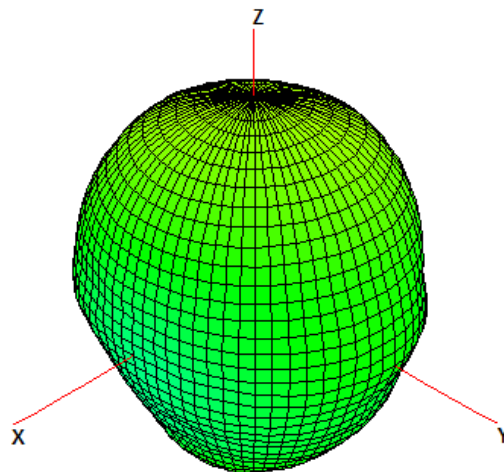



## 5. Mechanical Drawing – Antenna

### 5.1 Antenna Dimension and Drawing

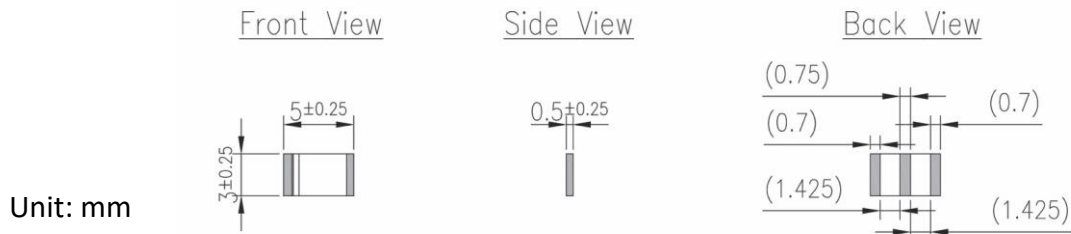

### 5.2 Antenna Footprint

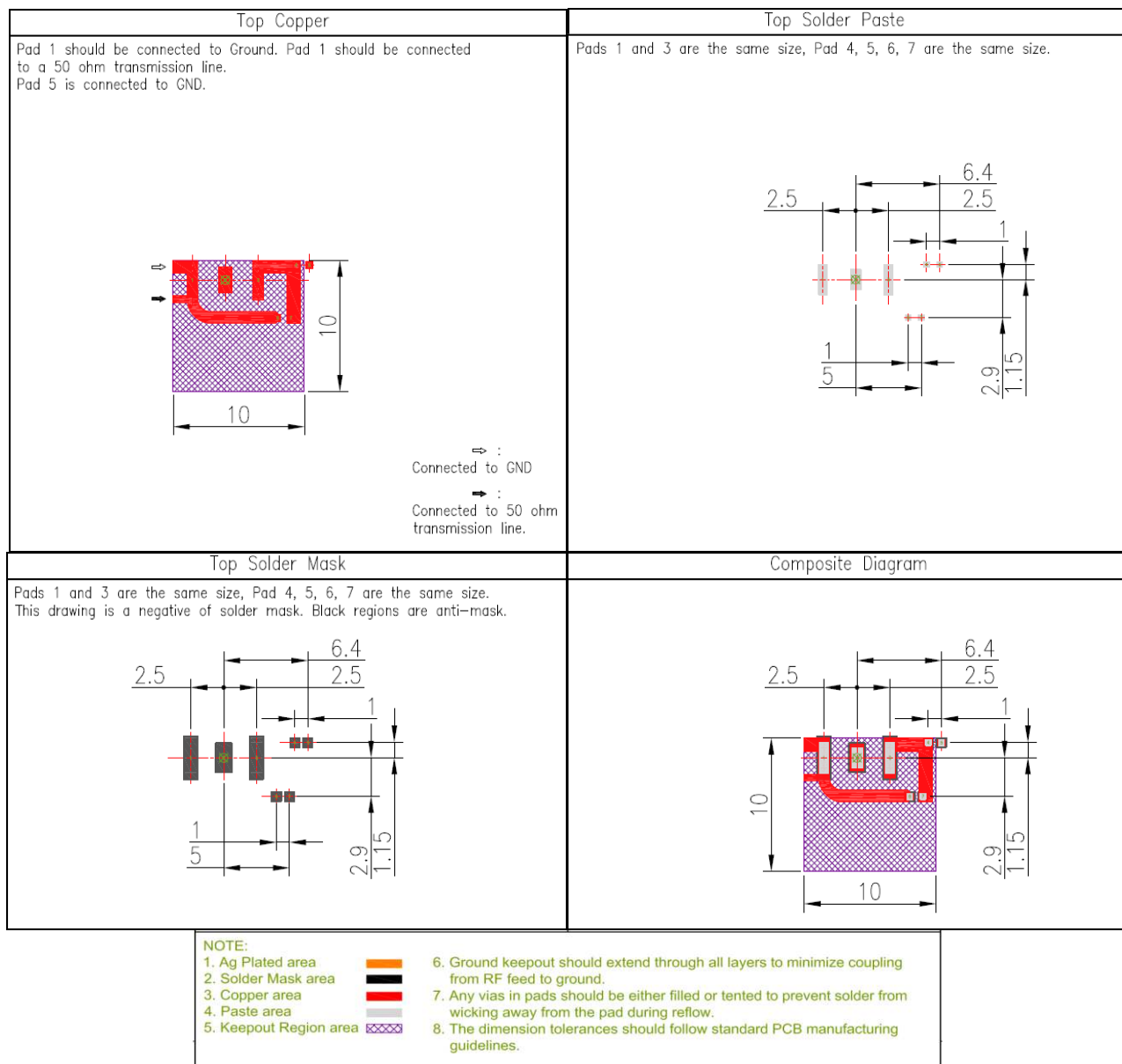

\*Taoglas is able to provide CAD drawing file to customers for evaluation.

## 5.2 Matching Circuit

Like all antennas, surrounding components, enclosures, and changes to the GND plane dimensions can alter performance. A pi-matching network like the one shown below is required incase adjustments need to be made. The antenna EVB has the same matching network. The components on the EVB are a good starting point for a new design, but will need to be adjusted upon integration for best performance. The zero ohm resistor is needed to solder down a coax pigtail to make measurements with a vector network analyzer.

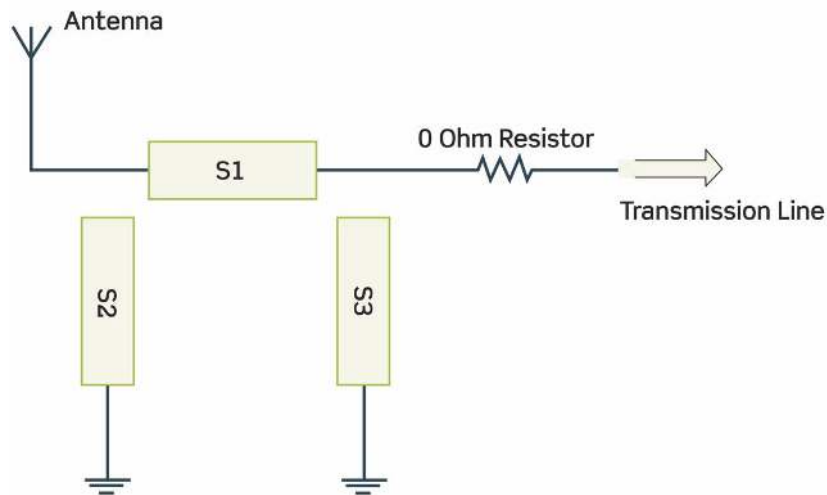

## 6. Antenna Integration Guide

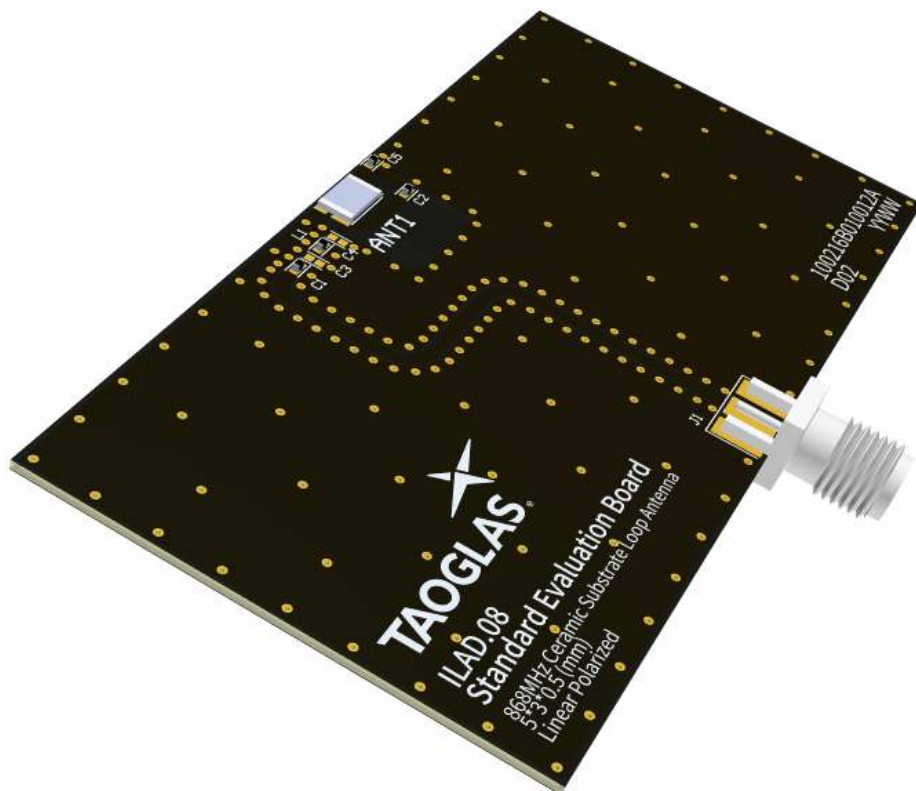
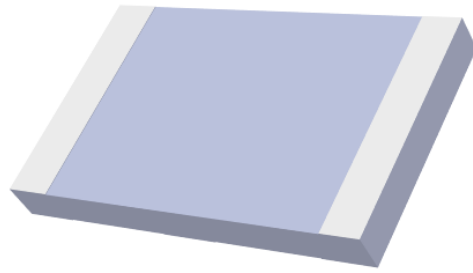

## 6.1 Schematic Symbol and Pin Definition

The circuit symbol for the antenna is shown below. The antenna has 4 pins with only three pins (Pin 1, Pin 2, and Pin 4) as functional. Pin 3 is for mechanical strength.

Pin	Description
1	RF Feed
2	FTE
3	Mechanical, Not Connected
4	Ground

ILA.08  
ANT1

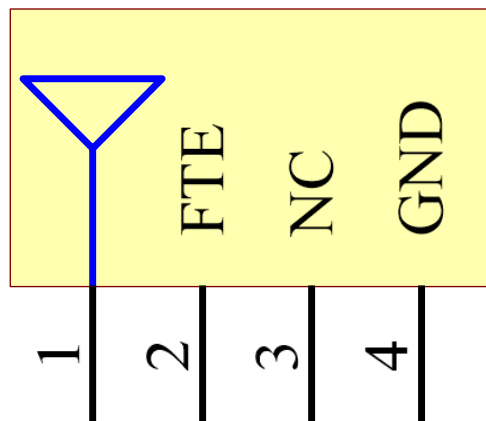

## 6.2 Antenna Integration

For any given PCB size, the antenna should ideally be placed on the PCB's longest side, to take advantage of the ground plane. Optimized matching components can be placed as shown.

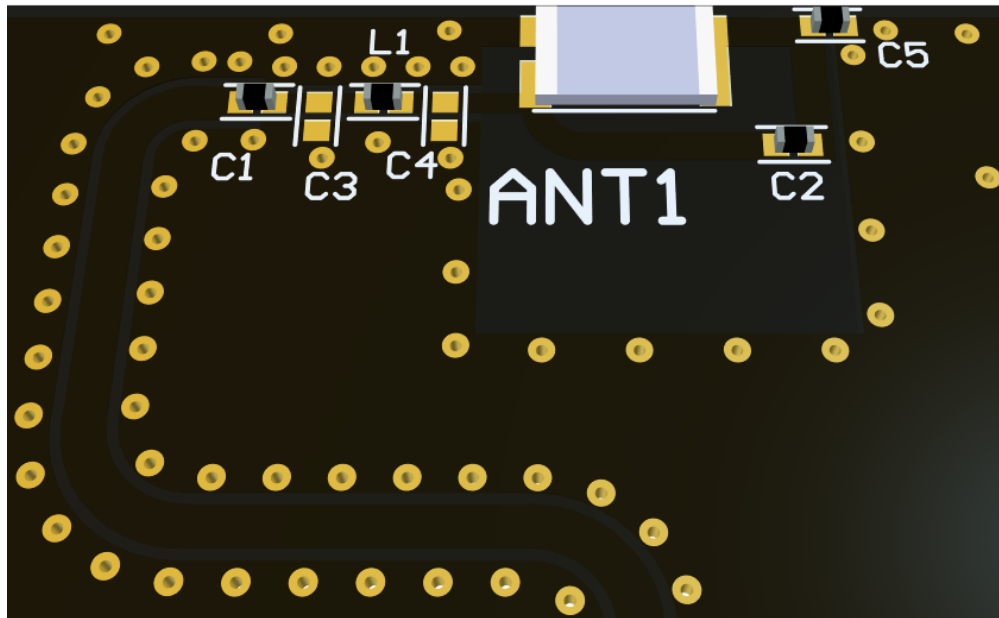

Top Side w/ Solder Mask

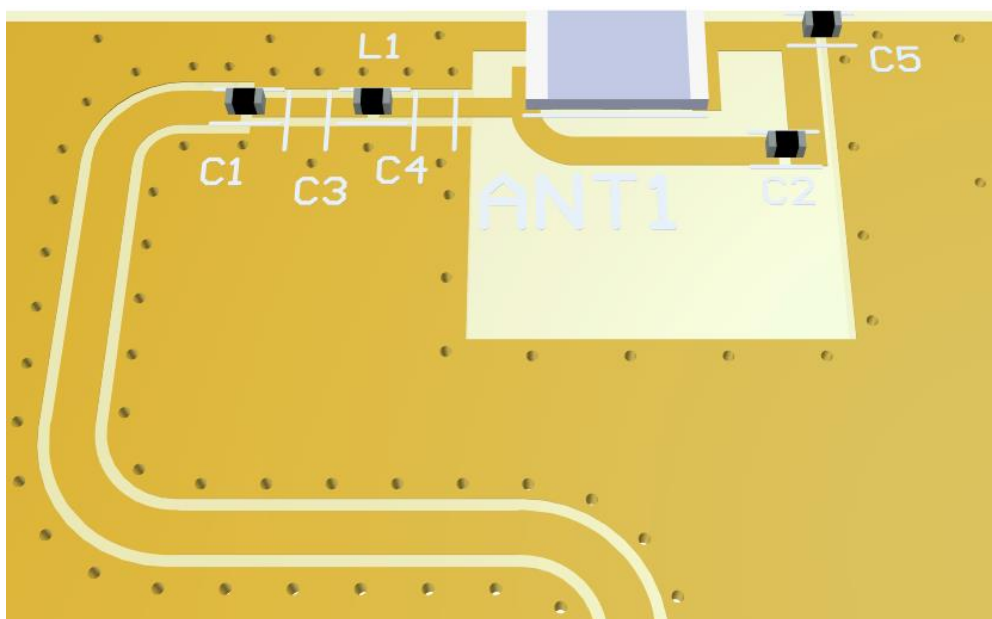

Top Side w/o Solder Mask

## 6.3 PCB Layout

The footprint and clearance on the PCB must meet the layout drawing in (Footprint Drawing). Note the placement of the optimized components. L1 is placed as close as possible to the RF feed (pad 1) but still within the transmission line. C1 is then placed tightly in series after that. C3 & C4 are optional components but the footprints are recommended in case they are needed. C5 is placed as close as possible to the tuning feed (pad 1) but still within the transmission line. C2 is then placed tightly in parallel after that connecting back to the RF Feed.

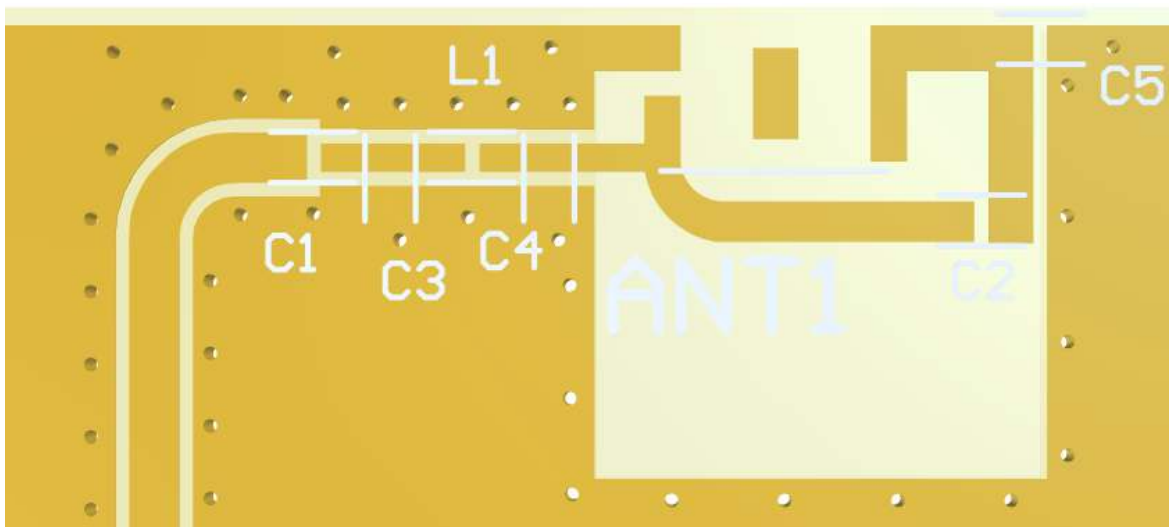

Topside

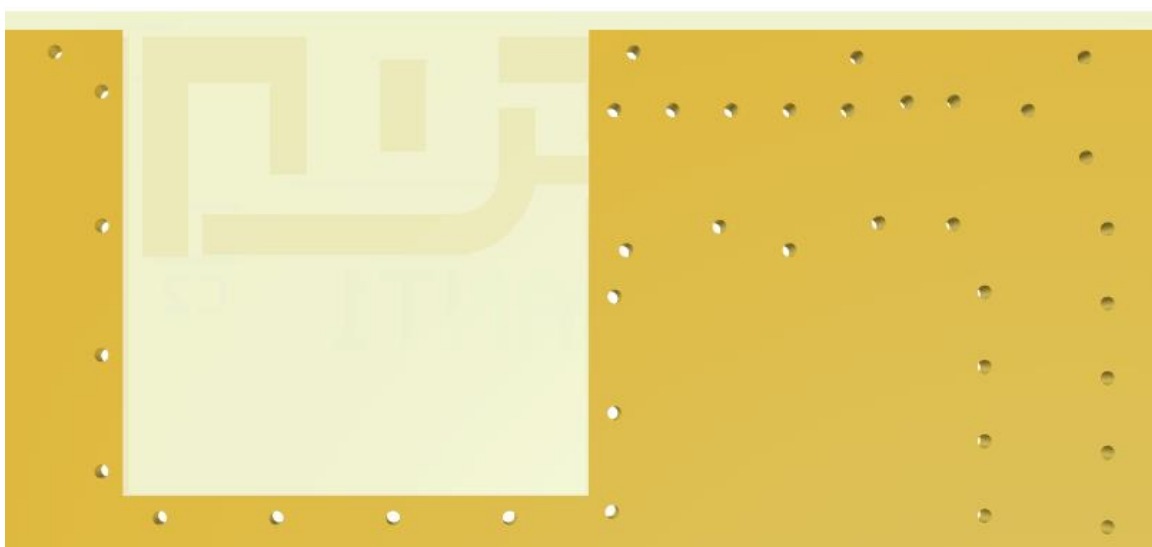

Bottom Side

## 6.4 PCB Clearance

Below shows the antenna footprint and clearance through ALL layers on the PCB. Only the antenna pads and connections to feed and GND are present within this clearance area (marked RED). The clearance area extends to 6.3mm in length and 7.6mm in width from the top center of the PCB. This clearance area includes the bottom side and ALL internal layers on the PCB.

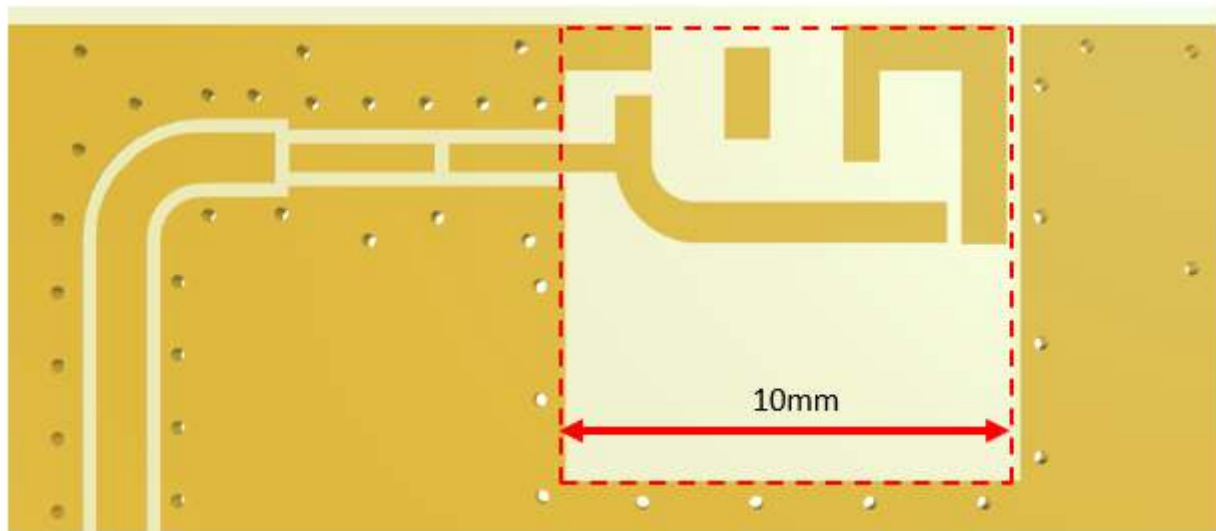

Topside

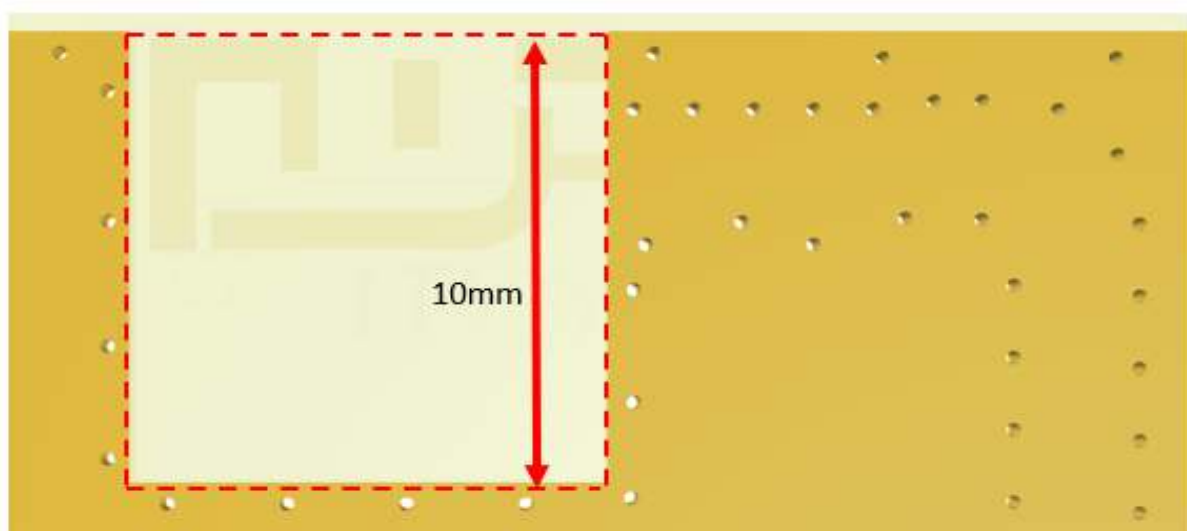

Bottom Side

6.5 Evaluation Board

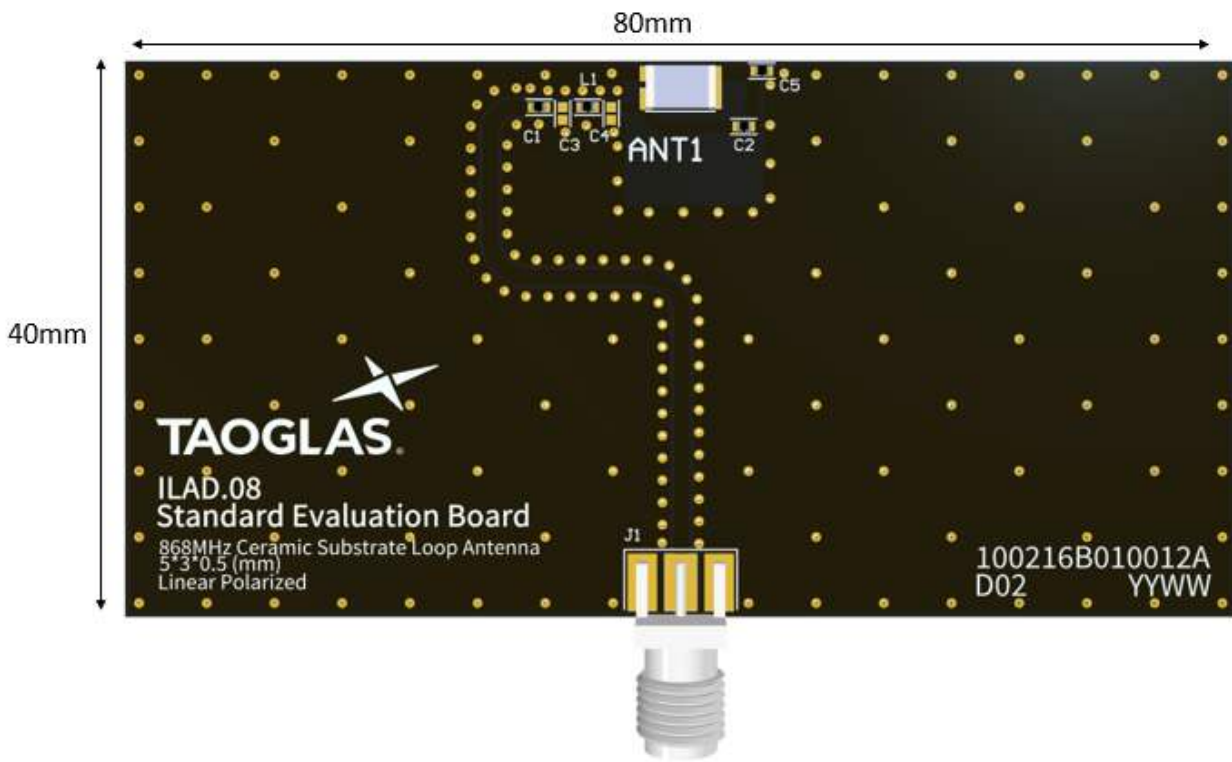

Topside

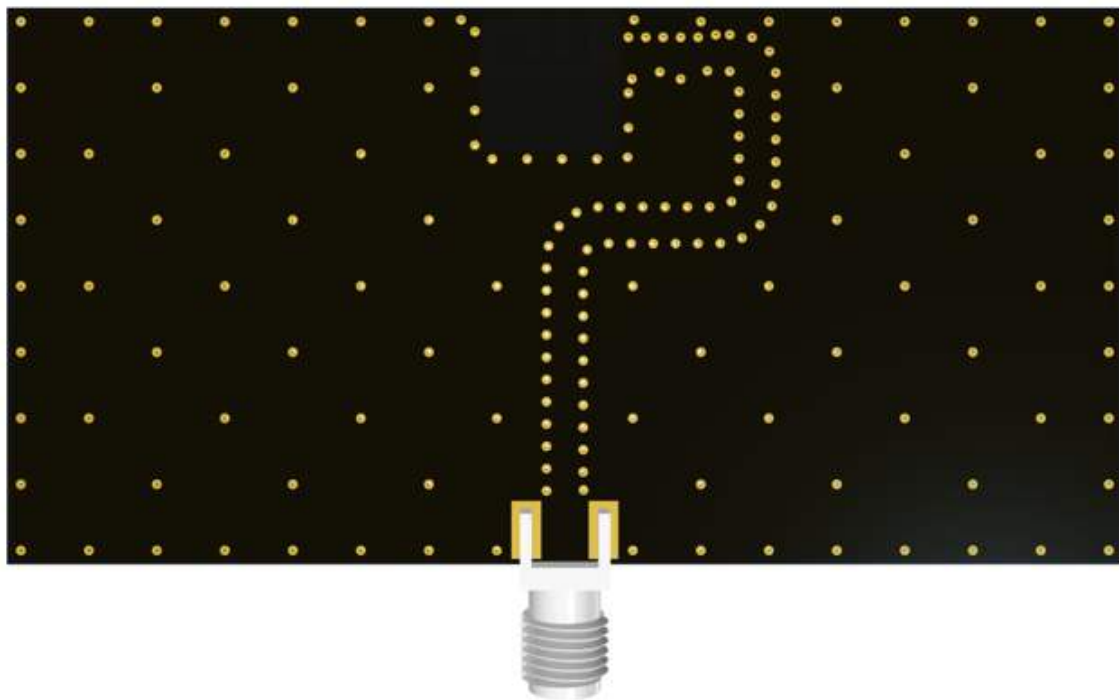

Bottom Side



## 6.6 Evaluation Board Matching Circuit

Matching components for the ILA.08 are required for the antenna to have optimal performance on the evaluation board, located outside of the copper clearance in the space specified in the above images. Additional matching components may be necessary for your device, so we recommend incorporating extra component footprints, forming a “pi” network, between the radio module and the antenna.

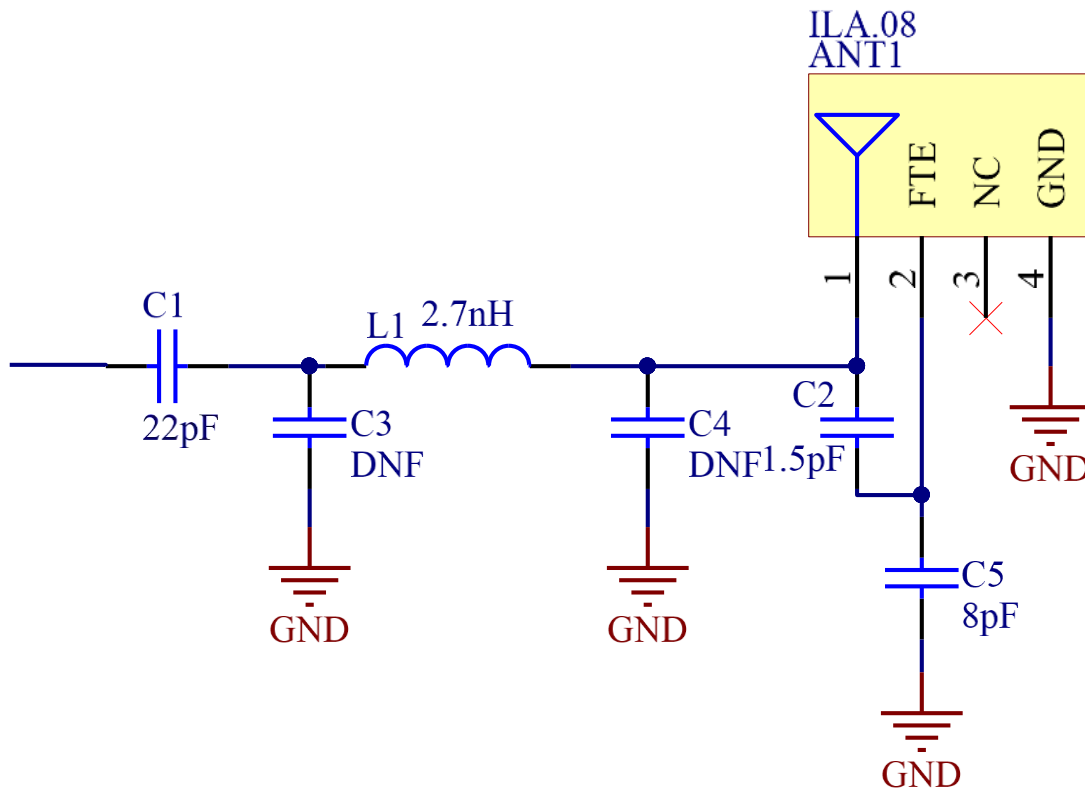

Designator	Type	Value	Manufacturer	Manufacturer Part Number
L1	Inductor	8.7nH	TDK	MLK1005S2N7ST000
C1	Capacitor	22pF	Murata	GRM1555C1H220JA01D
C2	Capacitor	1.5pF	Murata	GRM1555C1H1R5CA01D
C3	Capacitor	Not Fitted	-	-
C4	Capacitor	Not Fitted	-	-
C5	Capacitor	8pF	Murata	GRM1555D1H8R0DA01D

# 7. Mechanical Drawing – Evaluation Board

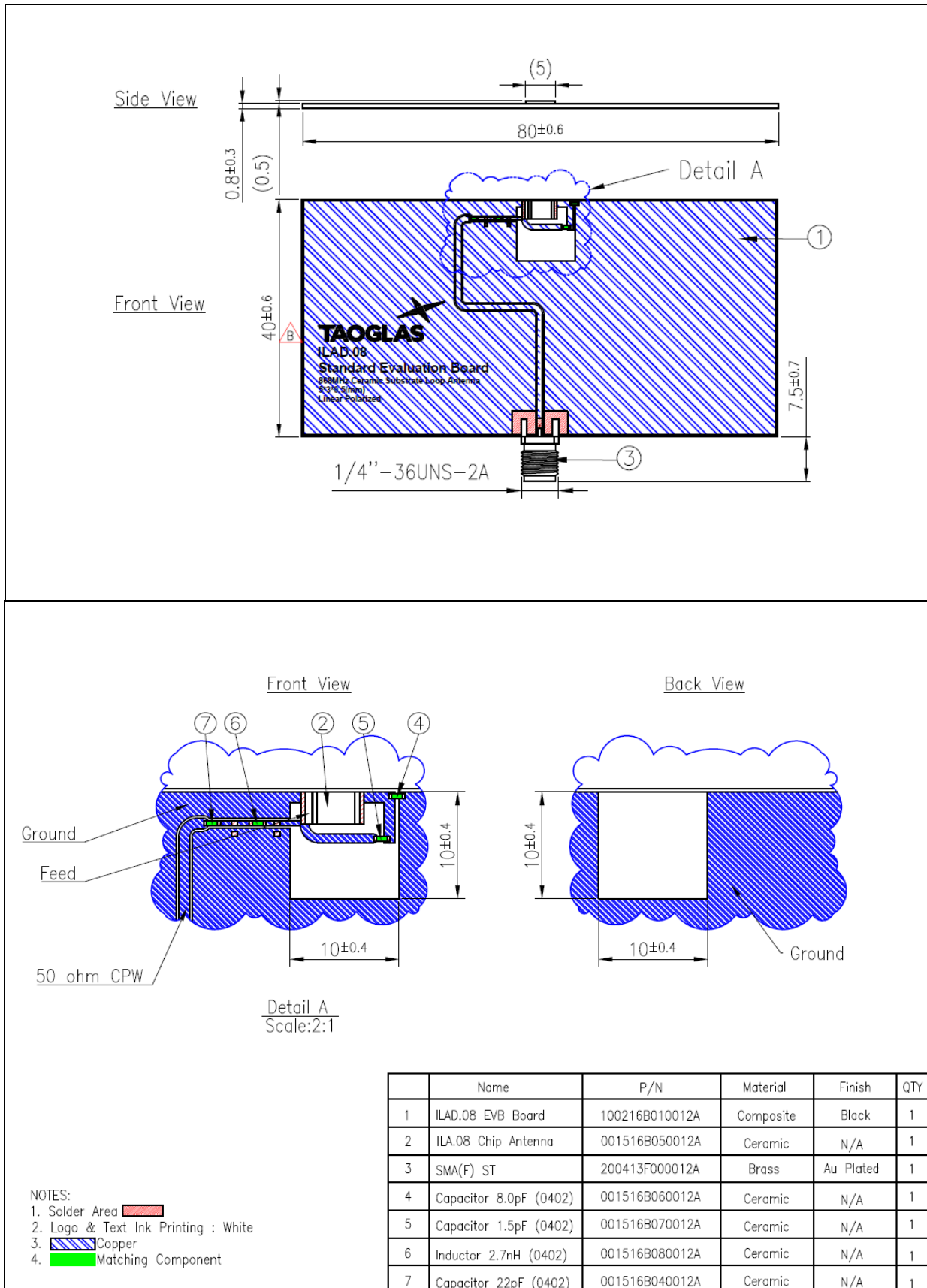

## 8. Soldering Conditions

Typical Soldering profile for lead-free process:

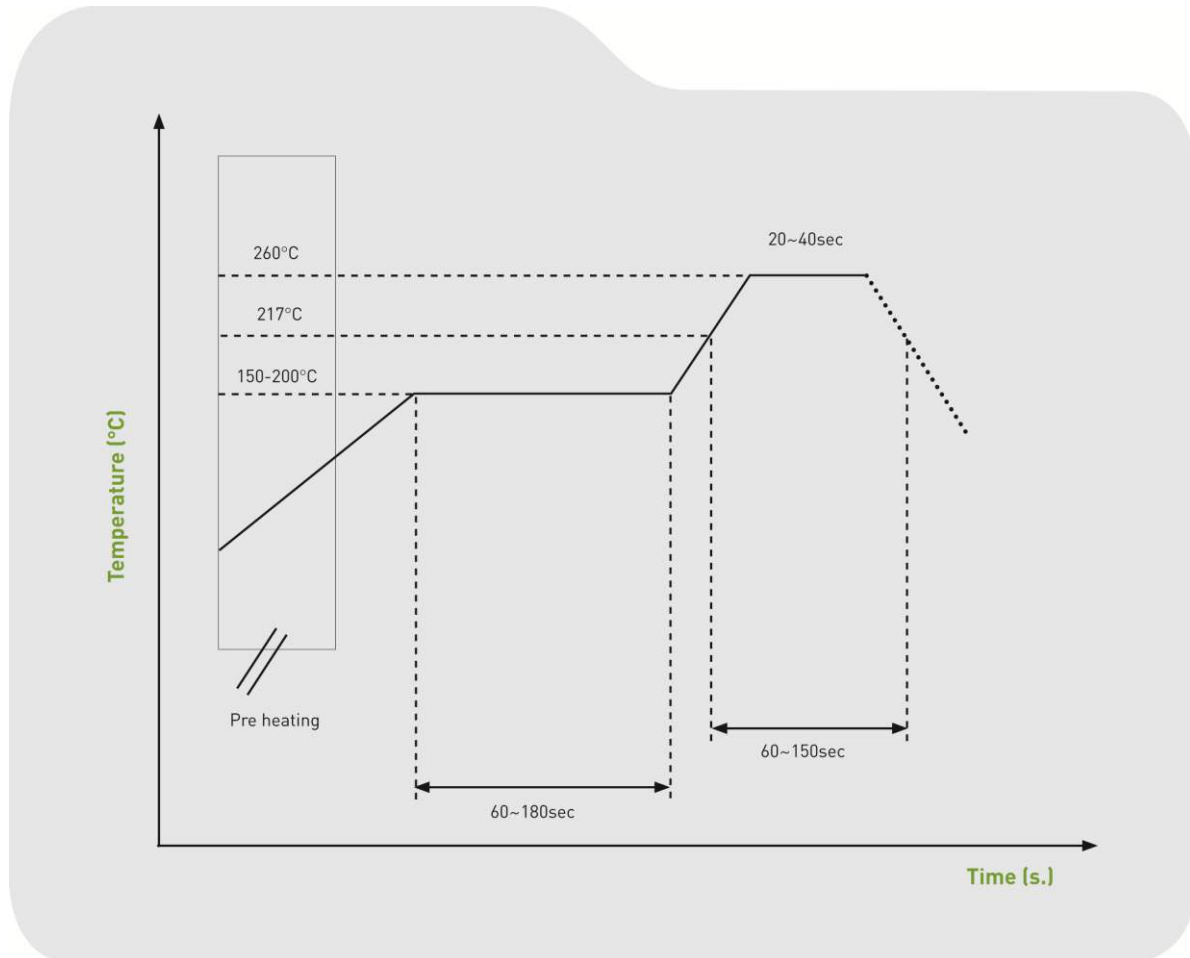

## 9. Packaging

6000 pcs ILA.08 per tape & reel  
 Dimensions - 330\*330\*17mm  
 Weight - 680g

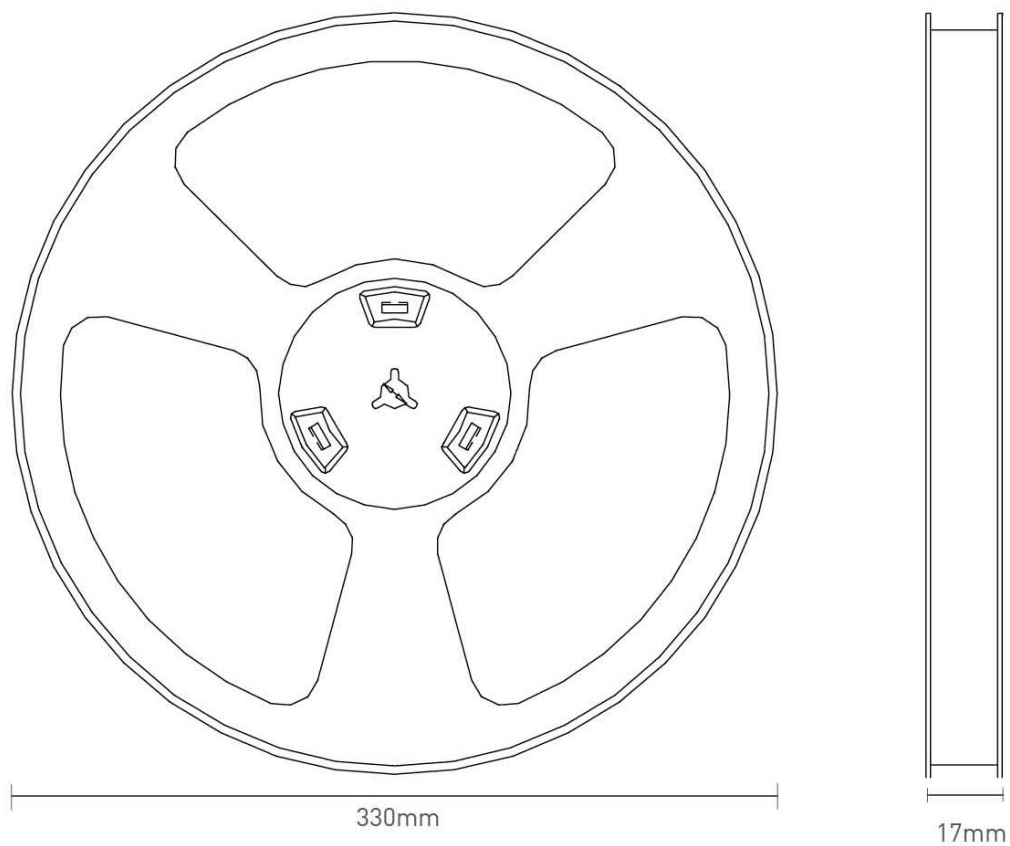

Tape Dimensions (unit: mm)		
Feature	Spec	Tolerances
W	12.00	±0.30
P	4.00	±0.10
E	1.75	±0.10
F	5.50	±0.10
P2	2.00	±0.10
D	1.50	+0.10 -0.00
Po	4.00	±0.10
10Po	40.00	±0.10

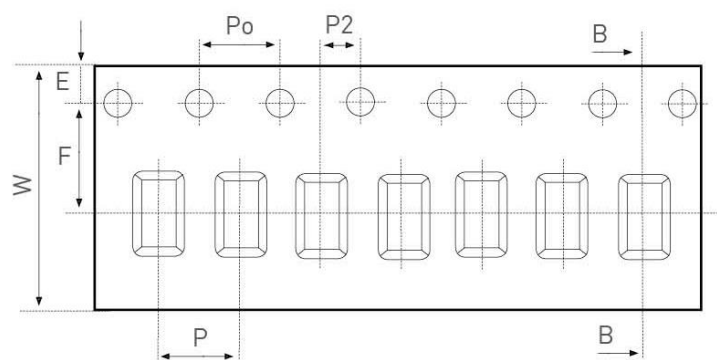

6000 pcs ILA.08  
 1 reel in small inner box  
 Dimensions - 330\*330\*17  
 Weight - 680g

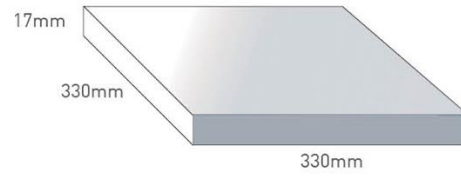

9 boxes / 54000 pcs in one carton  
 Carton Dimensions - 350\*350\*210mm  
 Weight - 6.69Kg

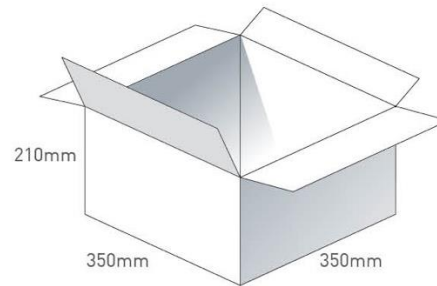

Pallet Dimensions 1220\*1020\*1410mm  
 36 Cartons per Pallet  
 4 Cartons per layer  
 9 Layers

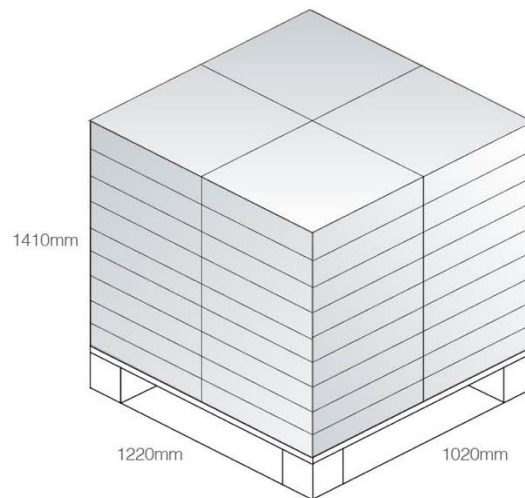

Changelog for the datasheet

**SPE-16-8-050 – ILA.08**

**Revision: C (Current Version)**

Date:	2023-03-13
Changes:	Antenna Integration Guide
Changes Made by:	Cesar Sousa

**Previous Revisions**

**Revision: B**

Date:	2021-10-31
Changes:	Format Change, MSL
Changes Made by:	Erik Landi

**Revision: A (Original First Release)**

Date:	2016-05-17
Notes:	Initial Release
Author:	STAFF



**TAOGLAS**®

[www.taoglas.com](http://www.taoglas.com)

