

Solid state

USB RF SP4T Switch Matrix

USB-2SP4T-63H

50Ω 10 to 6000 MHz

The Big Deal

- Very high isolation, 85 dB typ
- High speed switch transition, 5 μs typ
- High power handling, +30 dBm max
- Daisy-chain control of up to 35 modules



Software Package

Case Style: QM2605

Typical Applications

- Cellular handset / BTS testing
- High volume production testing / ATE
- Design verification testing
- RF signal routing / switch matrices

Model No.	Description	Qty.
USB-2SP4T-63H	Switch Matrix	1
Included Accessories		
MUSB-CBL-3+	2.6 ft USB cable	1

RoHS Compliant

See our web site for RoHS Compliance methodologies and qualifications

Product Overview

Mini-Circuits' USB-2SP4T-63H is a low cost, USB controlled, solid state matrix, containing two independent SP4T RF switches. Each fast switching, absorptive switch operates from 10 MHz to 6000 MHz with 5 μs typical switch transition speed. High linearity (+50 dBm typ IP3), and high isolation (85 dB typical) allow the model to be used for a wide variety of RF applications.

Full software support is provided for USB control, including our user-friendly GUI application for Windows and a full API with programming instructions for Windows and Linux environments (both 32-bit and 64-bit systems). The latest version of the full software package can be downloaded from <https://www.minicircuits.com/softwaredownload/solidstate.html> at any time.

The USB-2SP4T-63H is housed in a compact, low profile, rugged metal case (8.4" x 2.00" x 0.475") with 10 SMA (F) connectors (COM, 1 to 4 for each switch), a USB Mini-B port for power and control, and two data bus connectors for Master / Slave connections to other modules.

Key Features

Feature	Advantages
Two RF SP4T absorptive switches	Wideband (10 to 6000 MHz) with low insertion loss (2.5 dB typ.), high isolation (85 dB typ), and high power rating (+30 dBm through path).
High Linearity (IP3 50 dBm typ.)	Results in little or negligible inter-modulation generation, meeting requirements for digital communications signals
Internal DC Blocking capacitors	No need for external DC blocking circuitry
Dynamic daisy-chain control	Simplify control software and interconnections by cascading up to 35 modules of multiple switch types into a Master / Slave chain with a single USB interface.
Full software support included	Mini-Circuits' full software package, programming and user manual are available for download from https://www.minicircuits.com/softwaredownload/solidstate.html at no extra cost.

Trademarks: Windows is a registered trademark of Microsoft Corporation in the United States and other countries. Linux is a registered trademark of Linus Torvalds. Pentium is a registered trademark of Intel Corporation. Neither Mini-Circuits nor the Mini-Circuits USB-2SP4T-63H are affiliated with or endorsed by the owners of the above referenced trademarks

Mini-Circuits and the Mini-Circuits logo are registered trademarks of Scientific Components Corporation.



www.minicircuits.com P.O. Box 350166, Brooklyn, NY 11235-0003 (718) 934-4500 sales@minicircuits.com

Rev. C
M177221
EDR-11666/1
USB-2SP4T-63H
RAV
210114
Page 1 of 9

Electrical Specifications @ 0 to +50°C

Parameter	Port	Conditions	Min.	Typ.	Max.	Units
Operating Frequency			10		6000	MHz
Insertion Loss	COM to any active port	10 to 700 MHz	-	2.1	3.5	dB
		700 to 2500 MHz	-	2.5	4.0	
		2500 to 5000 MHz	-	2.9	4.3	
		5000 to 6000 MHz	-	3.3	4.7	
Isolation	Between ports 1 to 4 of a given switch	10 to 700 MHz	78	105	-	dB
		700 to 2500 MHz	74	105	-	
		2500 to 5000 MHz	63	90	-	
		5000 to 6000 MHz	58	80	-	
	COM to any terminated port of a given switch	10 to 700 MHz	77	105	-	
		700 to 2500 MHz	73	100	-	
		2500 to 5000 MHz	60	79	-	
	COM to port 1, 2, or 4 of a given switch (Disconnected state) ¹	5000 to 6000 MHz	58	70	-	
		10 to 700 MHz	77	105	-	
		700 to 2500 MHz	73	100	-	
		2500 to 5000 MHz	60	79	-	
	COM to port 3 of a given switch (Disconnected state) ¹	5000 to 6000 MHz	58	70	-	
		10 to 700 MHz	55	70	-	
		700 to 2500 MHz	37	48	-	
		2500 to 5000 MHz	30	39	-	
	Crosstalk between switches	5000 to 6000 MHz	28	36	-	
10 to 6000 MHz		85	100	-		
VSWR	COM port at all active states	10 to 700 MHz	-	1.25	-	:1
		700 to 2500 MHz	-	1.25	-	
		2500 to 5000 MHz	-	1.45	-	
		5000 to 6000 MHz	-	1.40	-	
	Any port connected to COM	10 to 700 MHz	-	1.25	-	
		700 to 2500 MHz	-	1.25	-	
		2500 to 5000 MHz	-	1.25	-	
		5000 to 6000 MHz	-	1.30	-	
	Any terminated port	10 to 700 MHz	-	1.20	-	
		700 to 2500 MHz	-	1.20	-	
		2500 to 5000 MHz	-	1.25	-	
		5000 to 6000 MHz	-	1.40	-	
Power Input @ 1 dB Compression	COM to any active port	100 to 6000 MHz	-	33	-	dBm
IP3 ²	COM to any active port	100 to 6000 MHz	-	50	-	dBm
Transition Time ³	-	-	-	5	8	µs
Minimum dwell time ⁴	High Speed Mode	-	-	15	-	µs
Switching Time (USB) ⁵	-	-	-	2	-	ms
Supply voltage (Vcc)	USB port	-	4.75	5	5.25	V _{DC}
Supply Current (Icc) ⁶		-	-	55	85	mA
Current Pass-through ⁷		-	-	-	500	
Operating RF Input Power	Any active port to COM port	Hot Switching	-	-	+23	dBm
	Any terminated port	-	-	-	+23	
	Through path	10 to 50 MHz	Max power at through path derates linearly from +30 dBm @ 50 MHz to +23 dBm @ 10 MHz			
50 to 6000 MHz		-	-	+30		

¹ In disconnected state COM port is reflective and ports 1-4 are absorptive, isolation COM to 1,2,4 is significantly better than COM to 3. See block diagram on page 3 for details.

² IP3 is tested with 1 MHz span between signals, +5 dBm per tone.

³ Transition time spec represents the time that the RF signal paths are interrupted during switching and thus is specified without communication delays.

⁴ Minimum dwell time is the shortest time that can be achieved between 2 switch transitions when programming an automated switch sequence.

⁵ Switching time(USB) is the time from issuing a single software command via USB to the switch state changing. The most significant factor is the host PC, influenced by CPU load and USB protocol. The time shown is an estimate for a medium CPU load and USB 2.0 connection.

⁶ Current consumption specified for a single unit without any slave modules.

⁷ Pass through current is the maximum current handling of a unit with slave modules attached. If controlling a large number of slave modules additional power supplies should be included to ensure this limit is not exceeded. See page 4 for details.

Absolute Maximum Ratings

Operating Temperature		0°C to 50°C
Storage Temperature		-20°C to 60°C
DC supply voltage max.		6V
RF power @ 10 - 6000 MHz into termination		+24 dBm
RF power @ Through path	10 to 50 MHz	Derate linearly from +35 dBm @ 50 MHz to +30 dBm @ 10 MHz
	50 to 6000 MHz	
DC voltage @ RF Ports		16V

Permanent damage may occur if any of these limits are exceeded. Operating in the range between operating power limits and absolute maximum ratings for extended periods of time may result in reduced life and reliability.

Connections

RF SP4T Switch A (COM 1, 2, 3, 4)	(SMA female)
RF SP4T Switch B (COM 1, 2, 3, 4)	(SMA female)
USB	(USB type Mini-B receptacle)
Serial In (Digital Control 2 port)	(Digital Snap Fit Connector)
Serial Out (Digital Control 1 port)	(Digital Snap Fit Connector)

Simplified Diagram

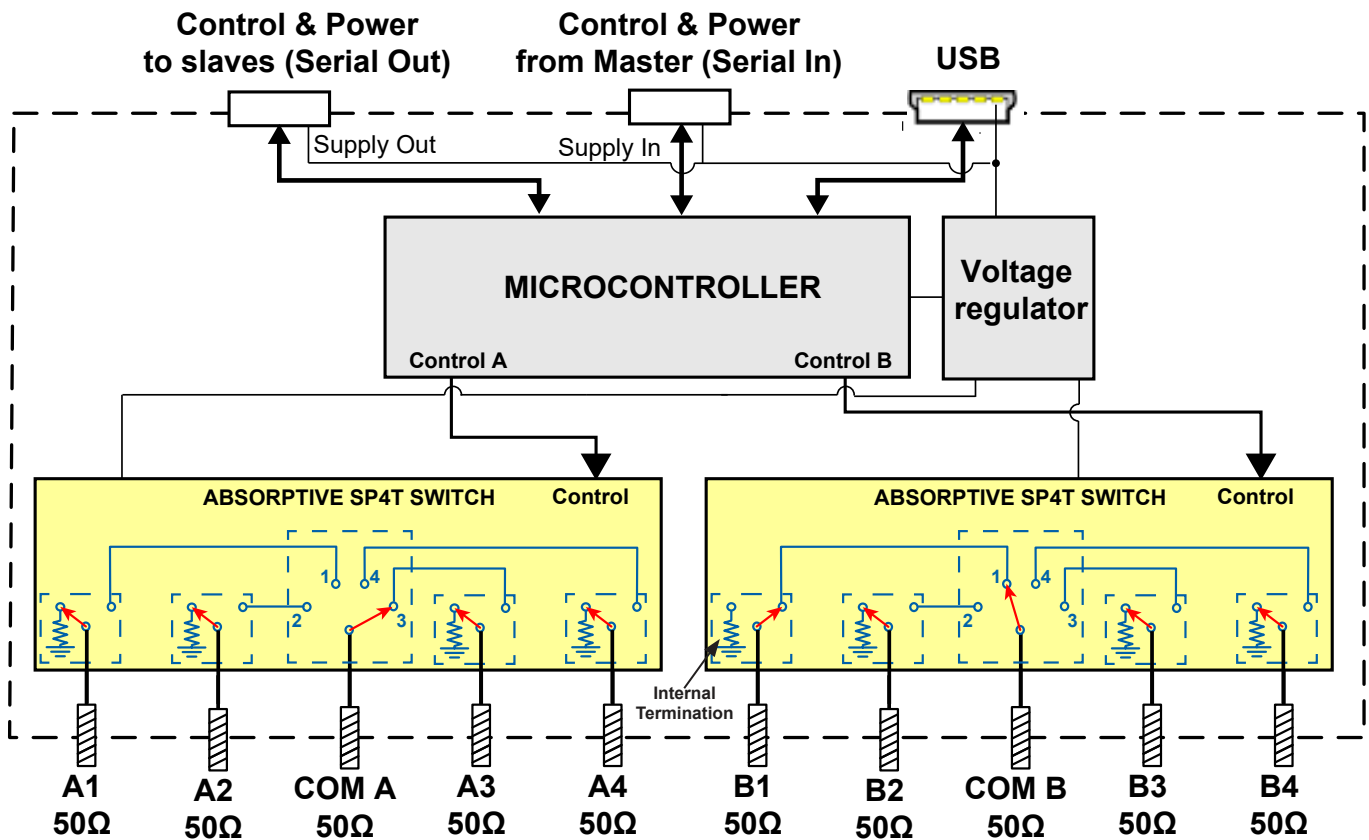

Connecting multiple modules (Daisy Chain)

The USB-2SP4T-63H is designed to connect up to 35 modules in series (Daisy chain) using dynamic addressing, meaning there is no need to specifically set the address of the modules, the addresses will be set automatically as part of establishing the communications with the PC. The module connected to the PC USB port will be assigned address 0 (Master), the first module connected to it will get address 1 (slave) and subsequent modules incrementing up to address 34 (slave).

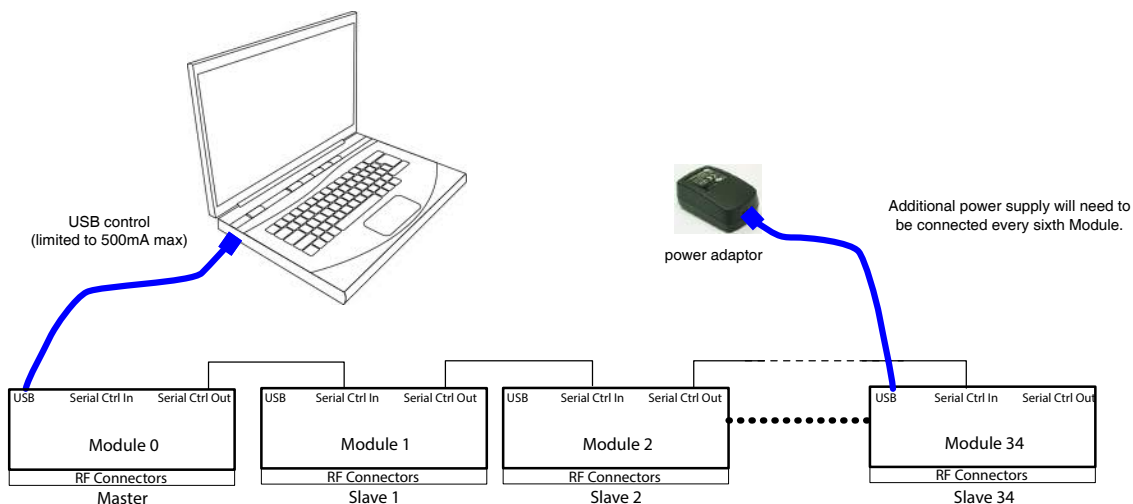

Connections between modules will be made using the serial in/out ports with the module connected to the PC as a master and all others as slave modules. All control will be through the master module (address zero) which is the only one communicating with the PC. Serial control out port of each module should be connected to the serial control in port of the next module. Power will be supplied from the PC via the master module up to a maximum of 500mA.

If connecting USB-2SP4T-63H units in series, additional power supply will generally be needed every six to eight modules. If mixing modules of different types ensure the max current through any unit does not exceed 500mA. All power supplies should be connected to the module via the module's USB port, connecting an additional power supply will automatically cut off power draw from the serial control in port for that module.

The Serial master/slave bus allows connecting modules of different types to the same daisy chain as long as all support Mini-Circuits Dynamic addressing setup. To add a new module to the set up simply connect the module to the setup and refresh the address listing, no need to reset any of the existing modules or assign addresses manually.

Connecting slave units should be done only with control cables provided by Mini-Circuits

Outline Drawing (QM2605)

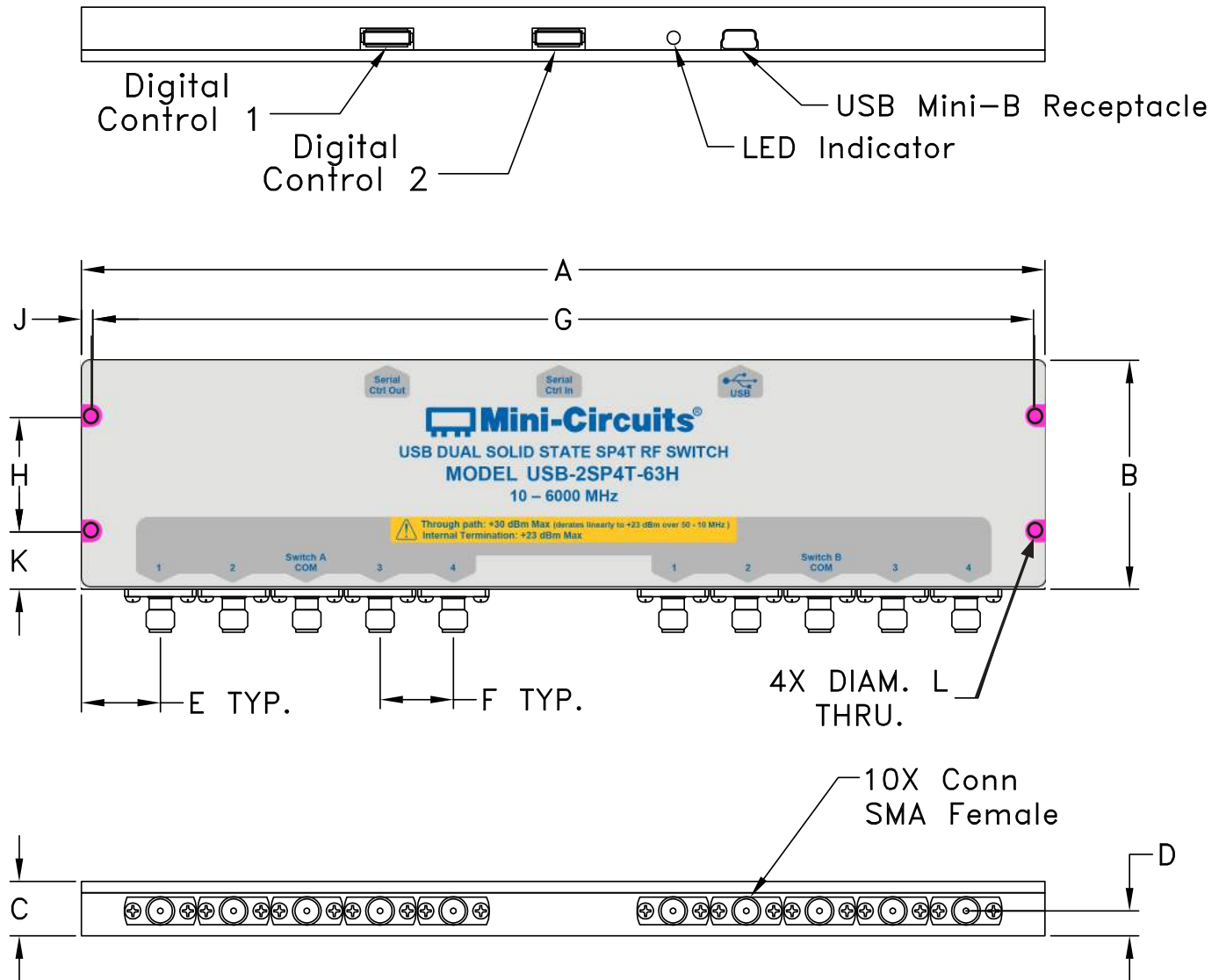

Outline Dimensions (inch / mm)

A	B	C	D	E	F	G	H	J	K	L	WT. GRAMS
8.42	2.00	0.475	0.217	0.69	0.640	8.220	1.000	0.10	0.50	0.106	450
213.9	50.8	12.06	5.51	17.53	16.26	208.79	25.40	2.54	12.70	2.69	

Typical Performance Curves

Insertion Loss J1 Active (over Temp.)

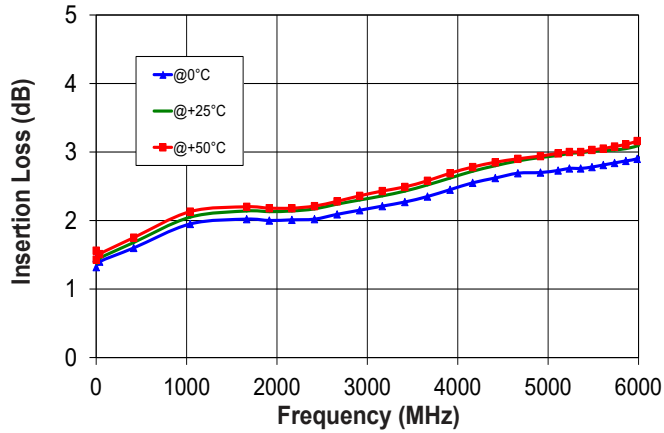

Insertion Loss J1/2/3/4 Active

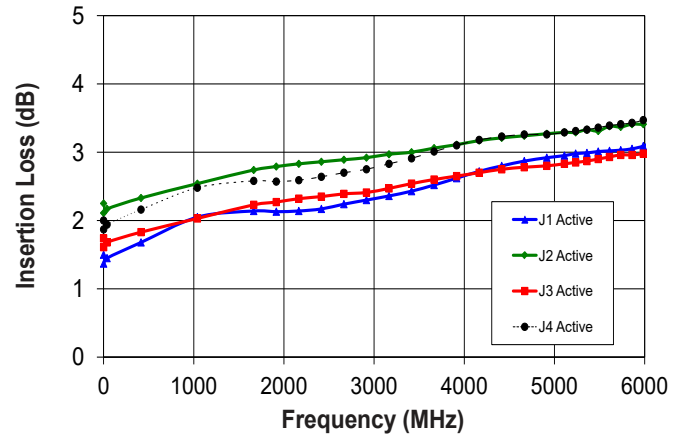

Isolation COM to J1 (J2 Active)

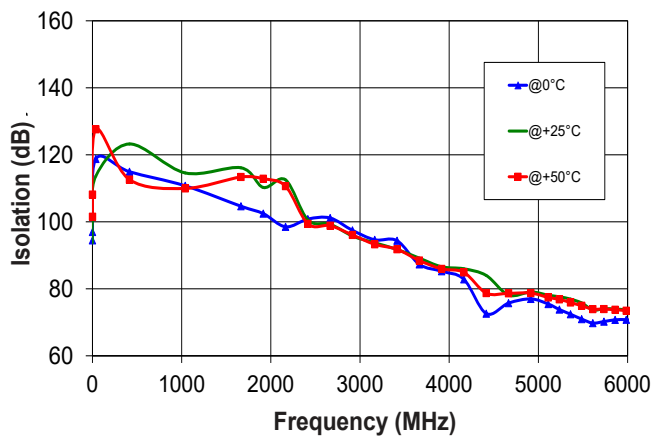

Isolation COM to J1 (J3 Active)

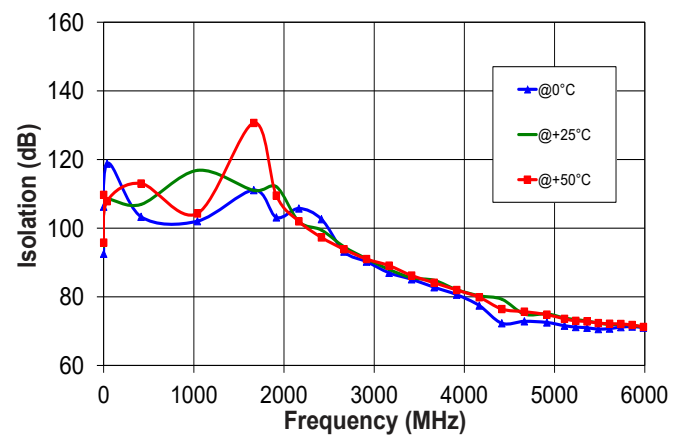

Isolation J2 to J3 (J3 Active)

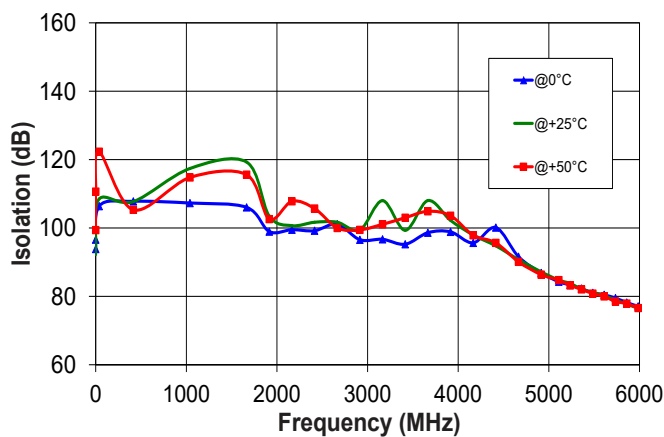

Isolation J1 to J3 (J2 Active)

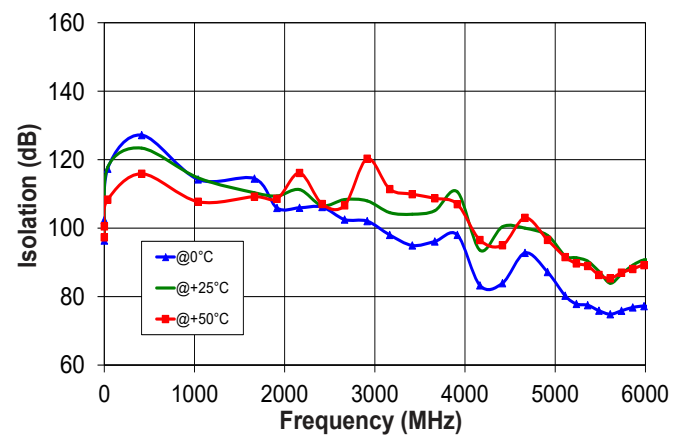

Typical Performance Curves (Continued)

VSWR @ COM over Temp. (J1 Active)

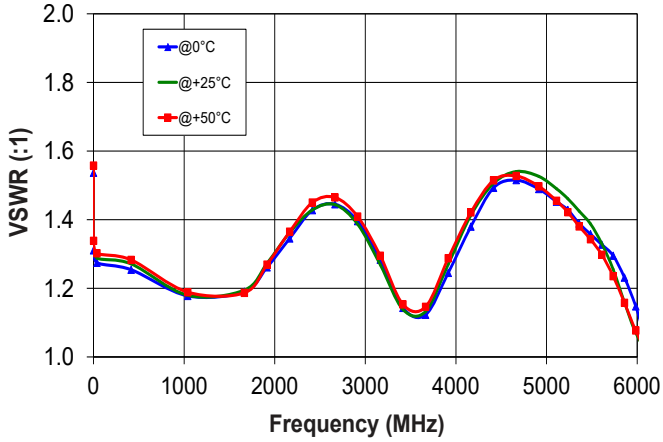

VSWR @ COM (J1/2/3/4 Active)

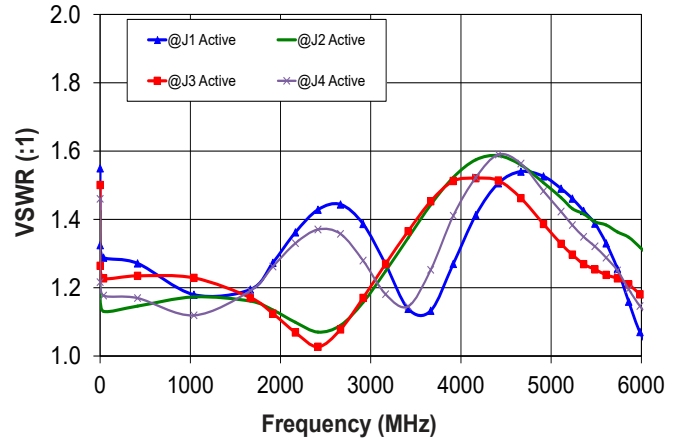

VSWR @ J1 Active Port over Temp.

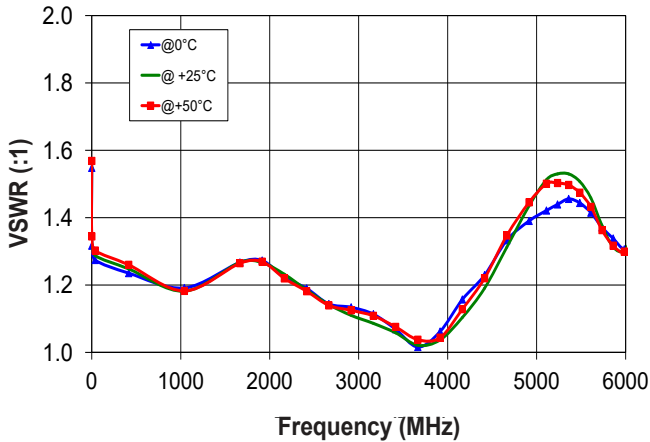

VSWR @ Active Ports J1/2/3/4

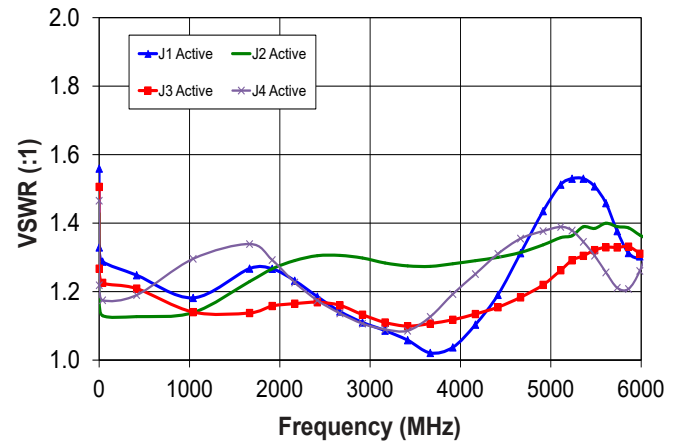

VSWR @ J1 Terminated over Temp.

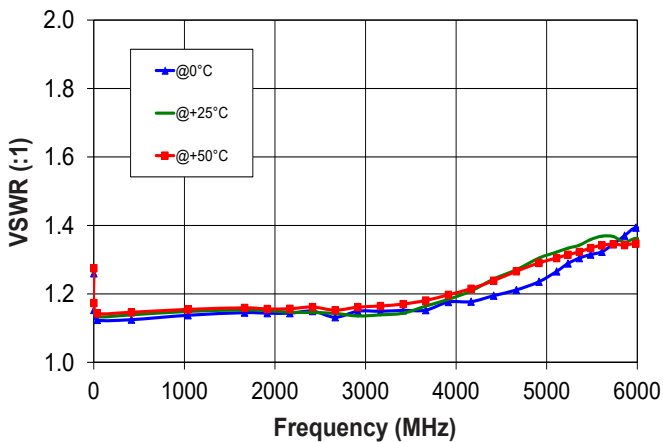

VSWR J1/2/3/4 Terminated Ports

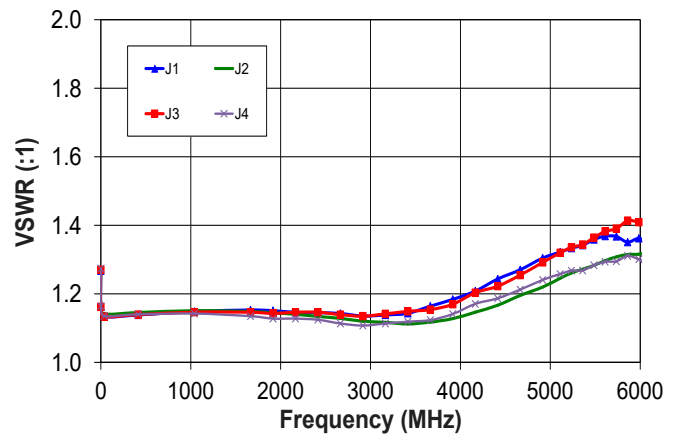

Software & Documentation Download:

- Mini-Circuits' full software and support package including user guide, Windows GUI, DLL files, programming manual and examples can be downloaded free of charge from <https://www.minicircuits.com/softwaredownload/solidstate.html>
- Please contact testsolutions@minicircuits.com for support

Minimum System Requirements

Parameter	Requirements	
Interface	USB HID	
System requirements	GUI	Windows 32 & 64 bit systems from Windows 98 up to Windows 10
	USB API (ActiveX & .Net)	Windows 32 & 64 bit systems with ActiveX or .Net support from Windows 98 up to Windows 10
	Daisy Chain Dynamic addressing	Additional unit of this model or another Mini-Circuits model supporting Dynamic addressing
	USB direct programming support	Linux, Windows systems from Windows 98 up to Windows 10
Hardware	Pentium® II or higher, RAM 256 MB	

Graphical User Interface (GUI) for Windows

Key Features:

- Set each switch manually
- Set timed sequence of switching states
- Configure switch address and upgrade Firmware
- Controlling up to 35 modules in 'daisy chain' configuration

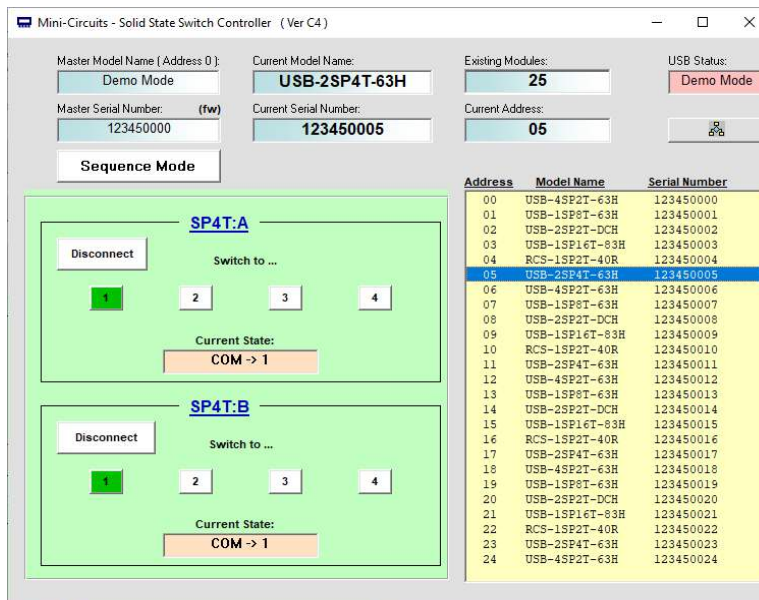

Application Programming Interface (API)

Windows Support:

- API DLL files exposing the full switch functionality See programming manual for details
 - ActiveX COM DLL file for creation of 32-bit programs
 - .Net library DLL file for creation of 32 / 64-bit programs
- Supported by most common programming environments (refer to application note [AN-49-001](#) for summary of tested environments)

Linux Support:

- Full switch control in a Linux environment is achieved by way of USB interrupt commands.

Ordering, Pricing & Availability Information see our web site

Model	Description
USB-2SP4T-63H	USB RF SP4T Switch matrix

Included Accessories	Part No.	Description
	MUSB-CBL-3+	2.6 ft (0.8 m) USB Cable: USB type A(Male) to USB type Mini-B(Male)

Optional Accessories	Description
MUSB-CBL-3+ (spare)	2.6 ft (0.8 m) USB Cable: USB type A(Male) to USB type Mini-B(Male)
MUSB-CBL-7+	6.6 ft (2.0 m) USB Cable: USB type A(Male) to USB type Mini-B(Male)
CBL-1.5FT-MMD+	1.5 ft cable assembly for serial control Daisy Chain with snap fit connectors
USB-AC/DC-5+	AC/DC +5V power adaptor with USB connector ^{8,9}

⁸ The USB-AC/DC-5 may be used to provide additional power if needing to connect a number of switches in series exceeding 500mA total current draw.

⁹ Includes power plugs for US, UK, EU, IL, AU & China. Plugs for other countries are also available, if you need a power plug for a country not listed please contact testsolutions@minicircuits.com

Additional Notes

- A. Performance and quality attributes and conditions not expressly stated in this specification document are intended to be excluded and do not form a part of this specification document.
- B. Electrical specifications and performance data contained in this specification document are based on Mini-Circuit's applicable established test performance criteria and measurement instructions.
- C. The parts covered by this specification document are subject to Mini-Circuits standard limited warranty and terms and conditions (collectively, "Standard Terms"); Purchasers of this part are entitled to the rights and benefits contained therein. For a full statement of the Standard Terms and the exclusive rights and remedies thereunder, please visit Mini-Circuits' website at www.minicircuits.com/MCLStore/terms.jsp