

## Flat suction pad (round)

SUF 5 HT1-60 M5-AG

Part no.:10.01.01.14230

<https://www.schmalz.com/10.01.01.14230>

Home > Vacuum Technology for Automation > Vacuum Components > Vacuum Suction Cups > Suction Cups for the Electronics Industry > Flat Suction Cups SUF > SUF 5 HT1-60 M5-AG

### Flat suction cup (round) for process safe handling of smooth or slightly rough surfaces



Size: 5

Suction cup material: High temp material HT1

Material hardness [Shore A]: 60 Shore A

Vacuum connection: M5-M

### Design Data

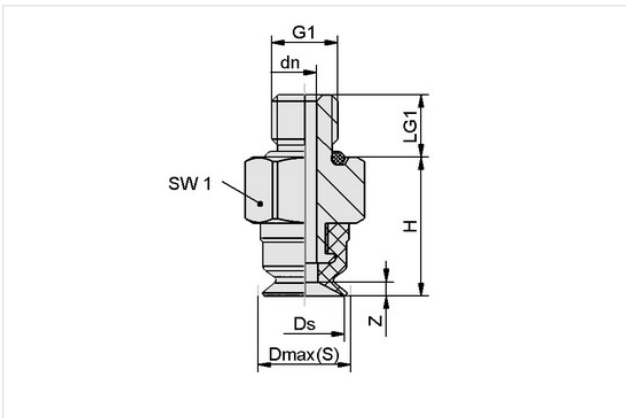

Attribute	Value
Dmax(S)	5.70 mm
Ds	5 mm
dn	1.80 mm
G1	M5-M
H	10.50 mm
LG1	4.70 mm
SW1	8 mm
Z (Stroke)	0.50 mm

### Technical Data

Attribute	Value
Suction force (-600mbar)	0.90 N
Pull-off force	0.90 N
Volume	0.01 cm <sup>3</sup>
Curve radius (min) (convex)	8 mm
Hose diameter (empf.) d	2 mm
Size	5
Suction cup material	High temp material HT1
Material hardness [Shore A]	60 Shore A

### Contact Schmalz

Schmalz Inc. | 5850 Oak Forest Drive, Raleigh, NC 27616, United States | +1 (919) 713-0880 | [schmalz.us@schmalz.com](mailto:schmalz.us@schmalz.com)

## Flat suction pad (round)

SUF 5 HT1-60 M5-AG

Part no...:10.01.01.14230

<https://www.schmalz.com/10.01.01.14230>

Weight	1 g
Product family	SUF
Number of folds	0

Note: Suction force: The specified suction forces are theoretical values at a vacuum of -0.6 bar and with a dry, smooth and flat workpiece surface - they do not include a safety factor  
Hose diameter: The recommended hose diameter refers to a hose length of approx. 2 m

### Spare parts



#### SC 020 M5-AG

Part no...:10.01.06.04273

Connection geometry: 020

Vacuum connection: M5-M

Fitting length: 5 mm

Nominal diameter dn: 1.8 mm



#### SUF 5 HT1-60 SC020

Part no...:10.01.01.13984

Size: 5

Suction cup material: High temp material HT1

Material hardness [Shore A]: 60 Shore A