

1KSMB Series

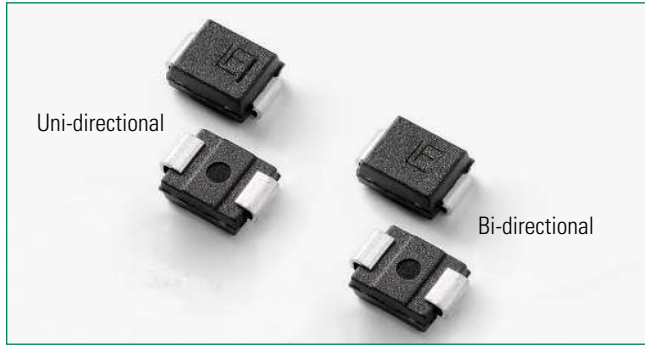

Agency Approvals

| Agency | Agency File Number |
|--------|--------------------|
| | E230531 |

Maximum Ratings and Thermal Characteristics
(T_A=25°C unless otherwise noted)

| Parameter | Symbol | Value | Unit |
|--|------------------|------------|------|
| Peak Pulse Power Dissipation at T _A =25°C by 10/1000µs Waveform (Fig.2)(Note 1), (Note 2) | P _{PPM} | 1000 | W |
| Power Dissipation on Infinite Heat Sink at T _L =50°C | P _D | 5.0 | W |
| Peak Forward Surge Current, 8.3ms Single Half Sine Wave (Note 3) | I _{FSM} | 120 | A |
| Maximum Instantaneous Forward Voltage at 50A for Unidirectional Only | V _F | 3.5 | V |
| Operating Temperature Range | T _J | -65 to 150 | °C |
| Storage Temperature Range | T _{STG} | -65 to 175 | °C |
| Typical Thermal Resistance Junction to Lead | R _{θJL} | 20 | °C/W |
| Typical Thermal Resistance Junction to Ambient | R _{θJA} | 100 | °C/W |

Notes:
 1. Non-repetitive current pulse, per Fig. 4 and derated above T_J (initial) =25°C per Fig. 3.
 2. Mounted on copper pad area of 0.2x0.2" (5.0 x 5.0mm) to each terminal.
 3. Measured on 8.3ms single half sine wave or equivalent square wave for unidirectional device only, duty cycle=4 per minute maximum.

Functional Diagram

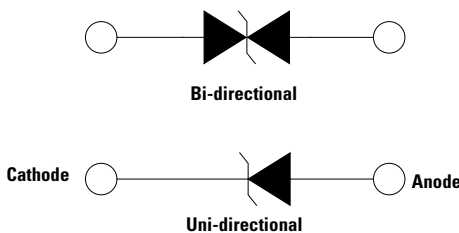

Description

The 1KSMB series is designed specifically to protect sensitive electronic equipment from voltage transients induced by lightning and other transient voltage events.

Features

- 1000W peak pulse power capability at 10/1000µs waveform, repetition rate (duty cycles):0.01 %
- For surface mounted applications to optimize board space
- Low profile package
- Typical failure mode is short from over-specified voltage or current
- Whisker test is conducted based on JEDEC JESD201A per its table 4a and 4c
- IEC-61000-4-2 ESD 30kV(Air), 30kV (Contact)
- ESD protection of data lines in accordance with IEC 61000-4-2
- EFT protection of data lines in accordance with IEC 61000-4-4
- Built-in strain relief
- V_{BR} @ T_J = V_{BR} @25°C x (1+αT x (T_J - 25)) (αT: Temperature Coefficient, typical value is 0.1 %)
- Glass passivated chip junction
- Fast response time: typically less than 1.0ps from 0V to BV min
- Excellent clamping capability
- Low incremental surge resistance
- Typical I_R less than 1µA when V_{BR} max>12V
- High temperature to reflow soldering guaranteed: 260°C/40sec
- Plastic package is flammability rated V-0 per Underwriters Laboratories
- Meet MSL level1, per J-STD-020, LF maximum peak of 260°C
- Matte tin lead-free Plated
- Available in breakdown Voltage from 6.8V to 180V specially designed for automotive applications
- Offers high-surge rating in compact package: bridges the gap between 600W and 1.5KW
- Halogen free and RoHS compliant
- Pb-free E3 means 2nd level interconnect is Pb-free and the terminal finish material is tin(Sn) (IPC/JEDEC J-STD-609A.01)

Applications

TVS devices are ideal for the protection of I/O Interfaces, V_{CC} bus and other vulnerable circuits used in Telecom, Computer, Industrial and Consumer electronic applications.

Additional Information



Electrical Characteristics (T_A=25°C unless otherwise noted)

| Part Number (Uni) | Part Number (Bi) | Marking | | Reverse Stand off Voltage V _R (Volts) | Breakdown Voltage V _{BR} (Volts) @ I _T | | Test Current I _T (mA) | Maximum Clamping Voltage V _C @ I _{PP} (V) | Maximum Peak Pulse Current I _{PP} (A) | Maximum Reverse Leakage I _R @ V _R (µA) | Agency Approval  |
|-------------------|------------------|---------|------|--|--|--------|----------------------------------|---|--|--|---|
| | | Uni | Bi | | Min. | Max. | | | | | |
| | | | | | | | | | | | |
| 1KSMB6.8A | 1KSMB6.8CA | A10A | N10A | 5.80 | 6.45 | 7.14 | 10 | 10.5 | 95.2 | 900 | x |
| 1KSMB7.5A | 1KSMB7.5CA | A10B | N10B | 6.40 | 7.13 | 7.88 | 10 | 11.3 | 88.5 | 400 | x |
| 1KSMB8.2A | 1KSMB8.2CA | A10C | N10C | 7.02 | 7.79 | 8.61 | 10 | 12.1 | 82.6 | 180 | x |
| 1KSMB9.1A | 1KSMB9.1CA | A10D | N10D | 7.78 | 8.65 | 9.55 | 1 | 13.4 | 74.6 | 45 | x |
| 1KSMB10A | 1KSMB10CA | A10E | N10E | 8.55 | 9.50 | 10.50 | 1 | 14.5 | 69.0 | 8 | x |
| 1KSMB11A | 1KSMB11CA | A10F | N10F | 9.40 | 10.50 | 11.60 | 1 | 15.6 | 64.1 | 4 | x |
| 1KSMB12A | 1KSMB12CA | A10G | N10G | 10.20 | 11.40 | 12.60 | 1 | 16.7 | 59.9 | 1 | x |
| 1KSMB13A | 1KSMB13CA | A10H | N10H | 11.10 | 12.40 | 13.70 | 1 | 18.2 | 54.9 | 1 | x |
| 1KSMB15A | 1KSMB15CA | A10I | N10I | 12.80 | 14.30 | 15.80 | 1 | 21.2 | 47.2 | 1 | x |
| 1KSMB16A | 1KSMB16CA | A10J | N10J | 13.60 | 15.20 | 16.80 | 1 | 22.5 | 44.4 | 1 | x |
| 1KSMB18A | 1KSMB18CA | A10K | N10K | 15.30 | 17.10 | 18.90 | 1 | 25.5 | 39.2 | 1 | x |
| 1KSMB20A | 1KSMB20CA | A10L | N10L | 17.10 | 19.00 | 21.00 | 1 | 27.7 | 36.1 | 1 | x |
| 1KSMB22A | 1KSMB22CA | A10M | N10M | 18.80 | 20.90 | 23.10 | 1 | 30.6 | 32.7 | 1 | x |
| 1KSMB24A | 1KSMB24CA | A10N | N10N | 20.50 | 22.80 | 25.20 | 1 | 33.2 | 30.1 | 1 | x |
| 1KSMB27A | 1KSMB27CA | A10O | N10O | 23.10 | 25.70 | 28.40 | 1 | 37.5 | 26.7 | 1 | x |
| 1KSMB30A | 1KSMB30CA | A10P | N10P | 25.60 | 28.50 | 31.50 | 1 | 41.4 | 24.2 | 1 | x |
| 1KSMB33A | 1KSMB33CA | A10Q | N10Q | 28.20 | 31.40 | 34.70 | 1 | 45.7 | 21.9 | 1 | x |
| 1KSMB36A | 1KSMB36CA | A10R | N10R | 30.80 | 34.20 | 37.80 | 1 | 49.9 | 20.0 | 1 | x |
| 1KSMB39A | 1KSMB39CA | A10S | N10S | 33.30 | 37.10 | 41.00 | 1 | 53.9 | 18.6 | 1 | x |
| 1KSMB43A | 1KSMB43CA | A10T | N10T | 36.80 | 40.90 | 45.20 | 1 | 59.3 | 16.9 | 1 | x |
| 1KSMB47A | 1KSMB47CA | A10U | N10U | 40.20 | 44.70 | 49.40 | 1 | 64.8 | 15.4 | 1 | x |
| 1KSMB51A | 1KSMB51CA | A10V | N10V | 43.60 | 48.50 | 53.60 | 1 | 70.1 | 14.3 | 1 | x |
| 1KSMB56A | 1KSMB56CA | A10W | N10W | 47.80 | 53.20 | 58.80 | 1 | 77.0 | 13.0 | 1 | x |
| 1KSMB62A | 1KSMB62CA | A10X | N10X | 53.00 | 58.90 | 65.10 | 1 | 85.0 | 11.8 | 1 | x |
| 1KSMB68A | 1KSMB68CA | A10Y | N10Y | 58.10 | 64.60 | 71.40 | 1 | 92.0 | 10.9 | 1 | x |
| 1KSMB75A | 1KSMB75CA | A10Z | N10Z | 64.10 | 71.30 | 78.80 | 1 | 103.0 | 9.7 | 1 | x |
| 1KSMB82A | 1KSMB82CA | B10A | O10A | 70.10 | 77.90 | 86.10 | 1 | 113.0 | 8.8 | 1 | x |
| 1KSMB91A | 1KSMB91CA | B10B | O10B | 77.80 | 86.50 | 95.50 | 1 | 125.0 | 8.0 | 1 | x |
| 1KSMB100A | 1KSMB100CA | B10C | O10C | 85.50 | 95.00 | 105.00 | 1 | 137.0 | 7.3 | 1 | x |
| 1KSMB110A | 1KSMB110CA | B10D | O10D | 94.00 | 105.00 | 116.00 | 1 | 152.0 | 6.6 | 1 | x |
| 1KSMB120A | 1KSMB120CA | B10E | O10E | 102.00 | 114.00 | 126.00 | 1 | 165.0 | 6.1 | 1 | x |
| 1KSMB130A | 1KSMB130CA | B10F | O10F | 111.00 | 124.00 | 137.00 | 1 | 179.0 | 5.6 | 1 | x |
| 1KSMB150A | 1KSMB150CA | B10G | O10G | 128.00 | 143.00 | 158.00 | 1 | 207.0 | 4.8 | 1 | x |
| 1KSMB160A | 1KSMB160CA | B10H | O10H | 136.00 | 152.00 | 168.00 | 1 | 219.0 | 4.6 | 1 | x |
| 1KSMB170A | 1KSMB170CA | B10I | O10I | 144.50 | 162.00 | 179.00 | 1 | 234.0 | 4.3 | 1 | x |
| 1KSMB180A | 1KSMB180CA | B10J | O10J | 153.00 | 171.00 | 189.00 | 1 | 246.0 | 4.1 | 1 | x |

For bidirectional type having V_s of 10 volts and less, the I_s limit is double.

For parts without A V_{min} is ± 10% and V_c is 5% higher than with A parts, the parts without A are currently available, but not recommended for new designs. The parts with A are preferred.

I-V Curve Characteristics

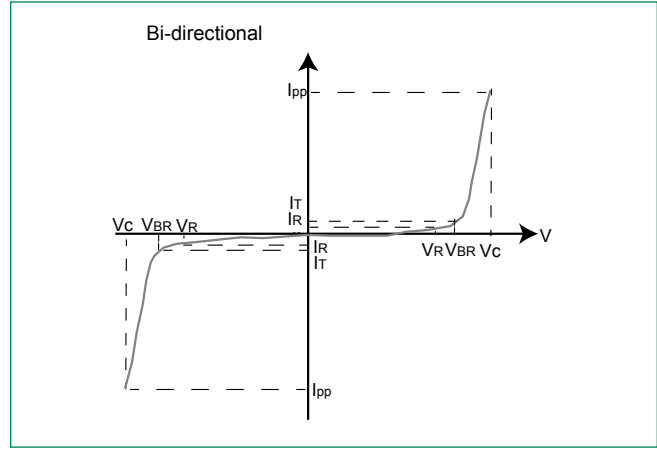
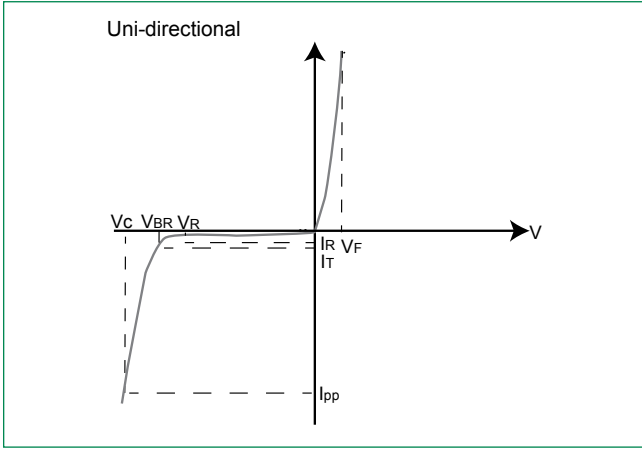

- P_{PPM} Peak Pulse Power Dissipation** – Max power dissipation
- V_R Stand-off Voltage** – Maximum voltage that can be applied to the TVS without operation
- V_{BR} Breakdown Voltage** – Maximum voltage that flows through the TVS at a specified test current (I_T)
- V_C Clamping Voltage** – Peak voltage measured across the TVS at a specified I_{ppm} (peak impulse current)
- I_R Reverse Leakage Current** – Current measured at V_R
- V_F Forward Voltage Drop for Uni-directional**

Ratings and Characteristic Curves ($T_A=25^\circ\text{C}$ unless otherwise noted)

Figure 1 - TVS Transients Clamping Waveform

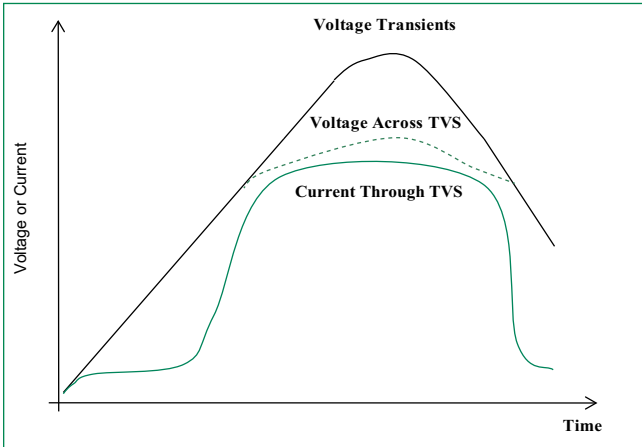
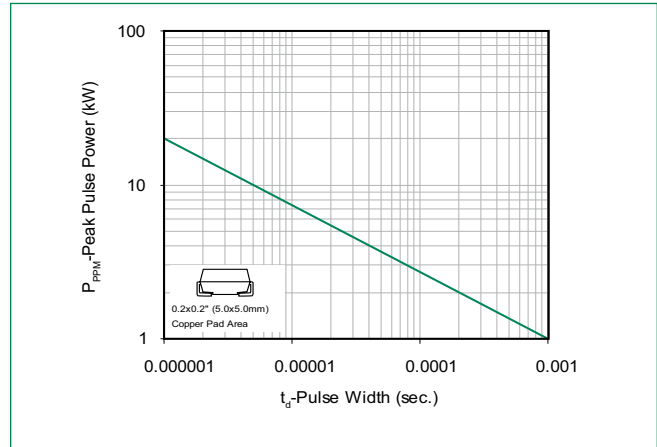

Figure 2 - Peak Pulse Power Rating Curve



Ratings and Characteristic Curves ($T_A=25^\circ\text{C}$ unless otherwise noted) (Continued)

Figure 3 - Peak Pulse Power Derating Curve

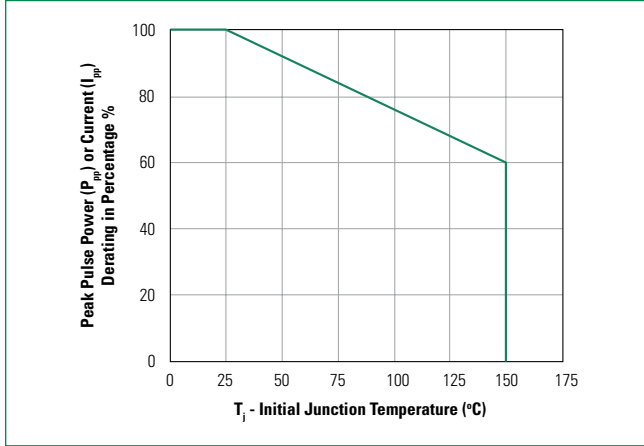

Figure 4 - Pulse Waveform

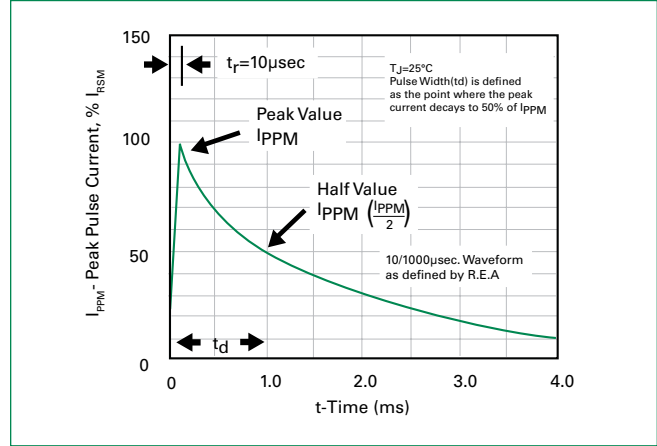

Figure 5 - Typical Junction Capacitance

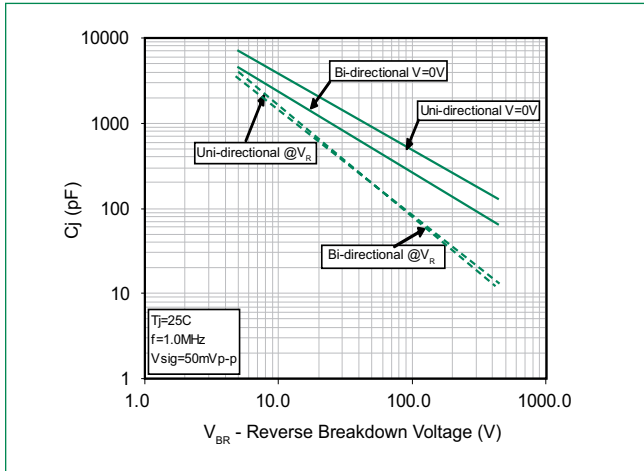

Figure 6 - Typical Transient Thermal Impedance

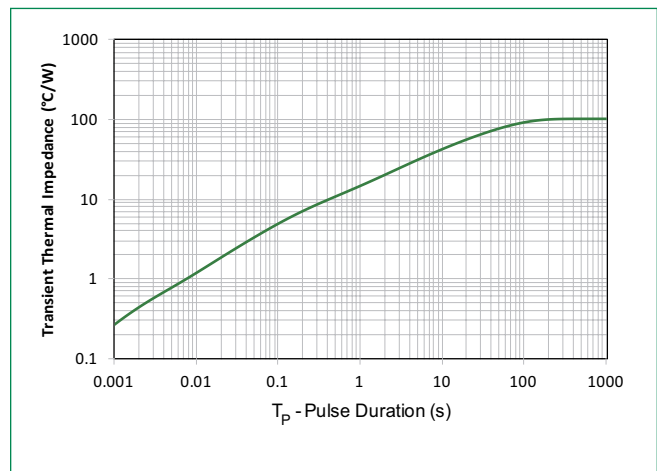

Figure 7 - Maximum Non-Repetitive Peak Forward Surge Current Uni-Directional Only

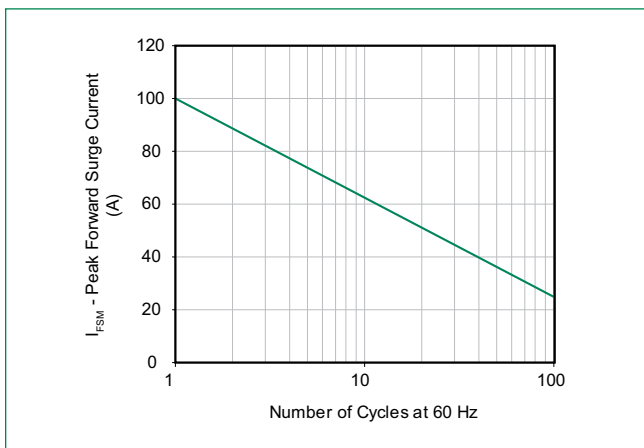
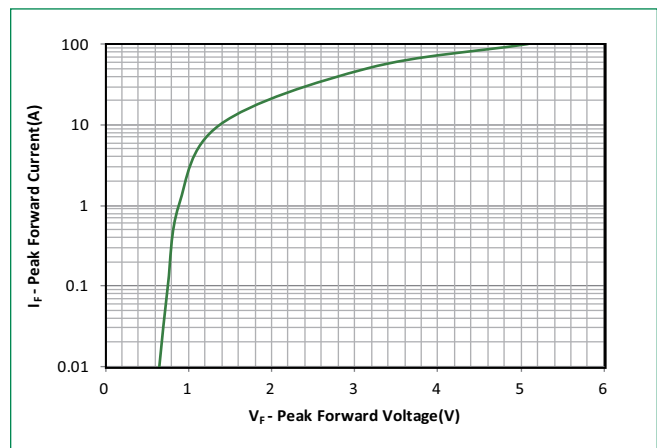
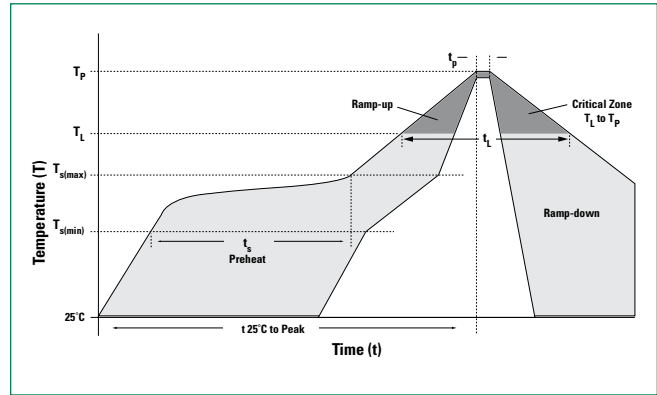

Figure 8 - Peak Forward Voltage Drop vs Peak Forward Current (Typical Values)



Soldering Parameters

| | | |
|--|------------------------------------|-------------------------|
| Reflow Condition | | Lead-free assembly |
| Pre Heat | - Temperature Min ($T_{s(min)}$) | 150°C |
| | - Temperature Max ($T_{s(max)}$) | 200°C |
| | - Time (min to max) (t_s) | 60 – 180 secs |
| Average ramp up rate (Liquidus Temp (T_A) to peak) | | 3°C/second max |
| $T_{s(max)}$ to T_A - Ramp-up Rate | | 3°C/second max |
| Reflow | - Temperature (T_A) (Liquidus) | 217°C |
| | - Time (min to max) (t_s) | 60 – 150 seconds |
| Peak Temperature (T_p) | | 260 ^{+0/-5} °C |
| Time within 5°C of actual peak Temperature (t_p) | | 20 – 40 seconds |
| Ramp-down Rate | | 6°C/second max |
| Time 25°C to peak Temperature (T_p) | | 8 minutes Max. |
| Do not exceed | | 260°C |



Physical Specifications

| | |
|-----------------|---|
| Weight | 0.003 ounce, 0.093 grams |
| Case | JEDEC DO214AA. Molded plastic body over glass passivated junction |
| Polarity | Color band denotes cathode except Bidirectional. |
| Terminal | Matte Tin-plated leads, Solderable per JESD22-B102 |

Environmental Specifications

| | |
|----------------------------|--------------------------|
| High Temp. Storage | JESD22-A103 |
| HTRB | JESD22-A108 |
| Temperature Cycling | JESD22-A104 |
| MSL | JEDEC-J-STD-020, Level 1 |
| H3TRB | JESD22-A101 |
| RSH | JESD22-A111 |

Dimensions

DO-214AA (SMB J-Bend)

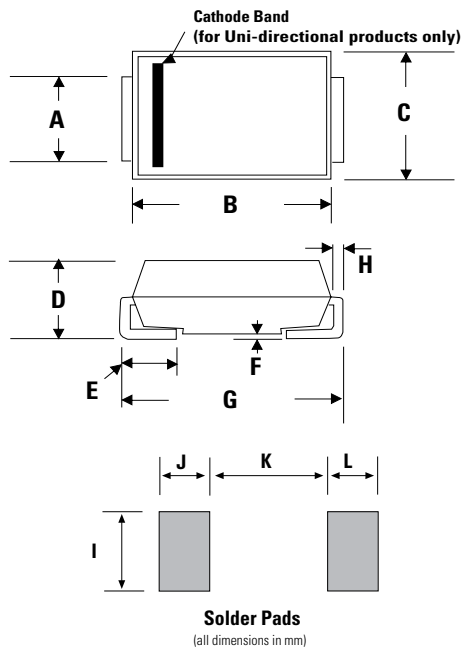

| Dimensions | Inches | | Millimeters | |
|------------|--------|-------|-------------|-------|
| | Min | Max | Min | Max |
| A | 0.077 | 0.086 | 1.950 | 2.200 |
| B | 0.160 | 0.180 | 4.060 | 4.570 |
| C | 0.130 | 0.155 | 3.300 | 3.940 |
| D | 0.084 | 0.096 | 2.130 | 2.440 |
| E | 0.030 | 0.060 | 0.760 | 1.520 |
| F | - | 0.008 | - | 0.203 |
| G | 0.205 | 0.220 | 5.210 | 5.590 |
| H | 0.006 | 0.012 | 0.152 | 0.305 |
| I | 0.089 | - | 2.260 | - |
| J | 0.085 | - | 2.160 | - |
| K | - | 0.107 | - | 2.740 |
| L | 0.085 | - | 2.160 | - |

Part Numbering System

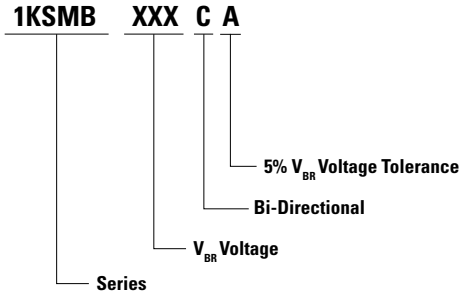

Part Marking System

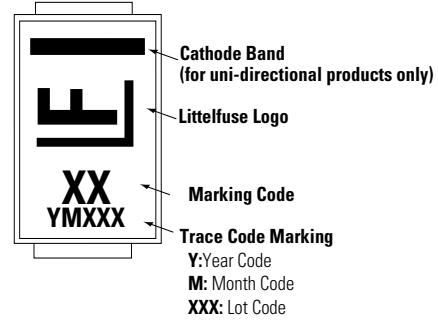

Packaging

| Part number | Component Package | Quantity | Packaging Option | Packaging Specification |
|-------------|-------------------|----------|----------------------------------|-------------------------|
| 1KSMBxxxXX | DO-214AA | 3000 | Tape & Reel - 12mm tape/13" reel | EIA STD RS-481 |

Tape and Reel Specification

