



A Product Line of
Diodes Incorporated



SPECIFICATION FOR APPROVAL

CUSTOMER _____

NOMINAL FREQUENCY 24.000000 MHz

HOLDER TYPE TYPE FK 3.2x2.5 SEAM SEALED CRYSTAL CLOCK OSCILLATOR

SPEC. NO. (P/N) FK2400045

CUSTOMER P/N _____

ISSUE DATE November 24, 2017

VERSION B

| APPROVED | PREPARED | QA |
|----------|----------|----|
| | | |

Diodes Incorporated

No.2, Ziqiang 5th Rd., Zhongli Industrial Park,
Zhongli Dist., Taoyuan City 32063, Taiwan (R.O.C.)
TEL: 886-3-451-8888
FAX: 886-3-461-3865
<https://www.diodes.com>

*Pb-free
*RoHS Compliant
*HF-Halogen Free
*REACH Compliant

TYPE FK 3.2x2.5 SEAM SEALED CRYSTAL CLOCK OSCILLATOR

FK2400045

VER. B 24-Nov-17

ELECTRICAL SPECIFICATIONS

SRe Part Number : FK2400045

| Item | Symbol | Specifications | Units | Notes |
|---------------------------------|--------------------------------|---------------------|-------|--------------------------------------|
| Nominal Frequency | Fo | 24.000000 | MHz | |
| Frequency Stability | FT | ± 25 | ppm | **See note |
| Operating Temperature Range | TR | -40 to +85 | °C | |
| Supply Voltage | V _{DD} | +1.8 to +3.3 | V | at +2.5V Typ. |
| Logic Type | LT | LVC MOS | | |
| Supply Current, Output Enabled | I _{DD} /OE | 8 | mA | Max. |
| Supply Current, Output Disabled | I _{DD} /OD | 10 | µA | Max. |
| Duty Cycle (Symmetry) | DC/SY | 45 / 55 | % | Measured 50% of Waveform |
| Rise / Fall Time | T _R /T _F | 5 | ns | Max. measured 10/90% of Waveform |
| Output Voltage "0" Level | V _{OL} | 10% V _{DD} | V | Max at I _{OL} = 4.0mA Min. |
| Output Voltage "1" Level | V _{OH} | 90% V _{DD} | V | Min at I _{OH} = -4.0mA Max. |
| Output Load | CL | 15 | pF | Max. |
| Jitter, Phase | RMS | 1 | ps | Max. 12KHz ~ 5MHz Frequency Band |
| Jitter, Accumulated | RMS(1-σ) | 3 | ps | Typ. 20,000 Consecutive Periods |
| Jitter, Peak to Peak | Pk-Pk | 30 | ps | Max. 100,000 Random Periods |
| Start Up Time | | 10 | ms | Max. |
| Storage Temperature Range | | -55 to +125 | °C | |

※ This product doesn't include harmful substance that stipulated by SONY SS-00259 Level 1 and S-AT2-001 Level 1 standard. RoHS Compliant (Pb - Free).

**Stability includes all combinations of Operating Temperature, Load changes, rated Input (Supply) Voltage changes, Initial Calibration Tolerance (25°C), Aging (1 year at 25°C Average Effective Ambient Temperature), Shock and Vibration.

Output Enable / Disable Function

| Parameter | Min. | Typ. | Max. | Units | Notes |
|----------------------------------------------------------|--------------------|------|--------------------|-------|----------------|
| Input Voltage (Pin1), Output Enable | 0.7V _{DD} | | | V | Or Open |
| Input Voltage (Pin1), Output Disable (low power standby) | | | 0.3V _{DD} | V | Output is Hi-Z |
| Internal Pullup Resistance | 30 | | | KΩ | |
| Output Disable Delay | | | 50 | ns | |



TYPE FK 3.2x2.5 SEAM SEALED CRYSTAL CLOCK OSCILLATOR

FK2400045

VER. B 24-Nov-17

TEST CIRCUIT

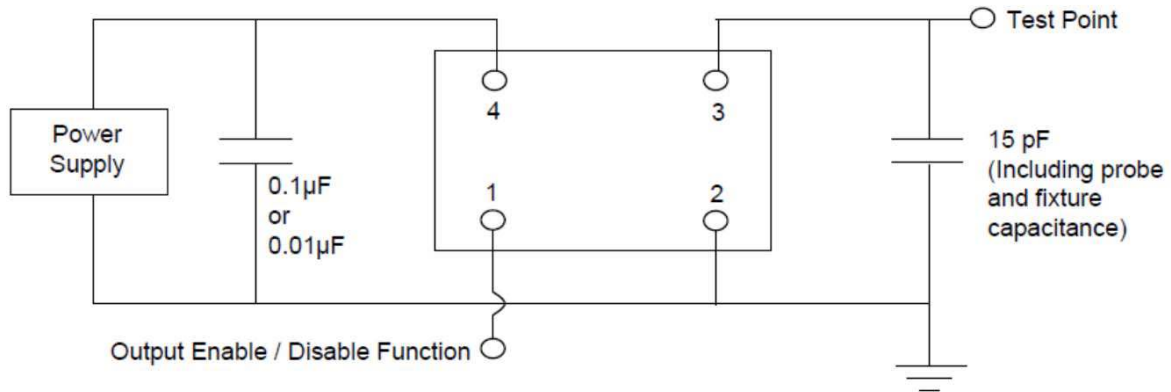

OUTPUT WAVEFORM

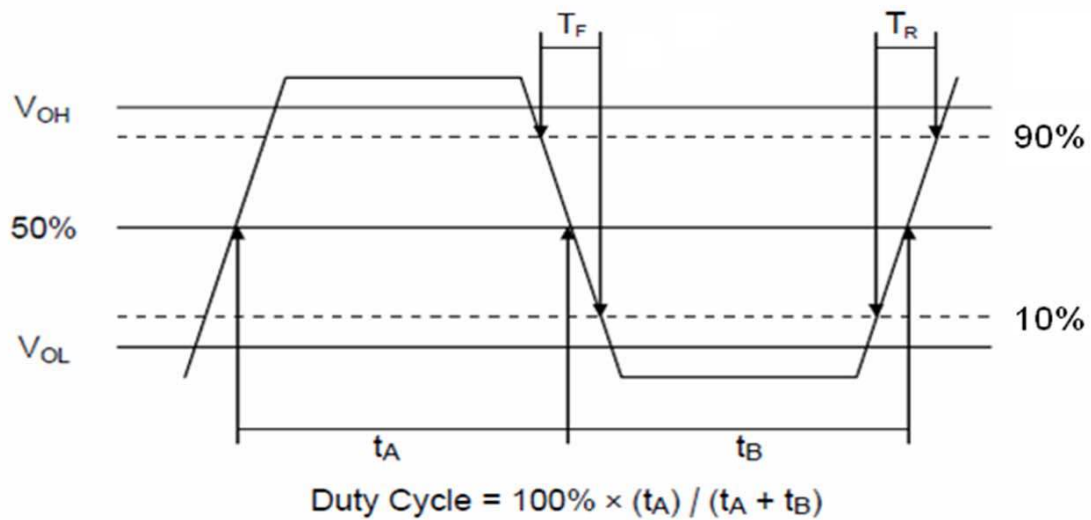

TYPE FK 3.2x2.5 SEAM SEALED CRYSTAL CLOCK OSCILLATOR

FK2400045

VER. B 24-Nov-17

RELIABILITY SPECIFICATIONS

ENVIRONMENTAL:

- a) THERMAL SHOCK: MIL-STD-883, Method 1011, Condition A
- b) MOISTURE RESISTANCE: MIL-STD-883, Method 1004
- c) VIBRATION: MIL-STD-883, Method 2007, Condition A
- d) RESISTANCE TO SOLDERING HEAT: J-STD-020D Table 5-2 Pb-free devices (except 2 cycles max)
- e) HAZARDOUS SUBSTANCE: Pb - free and RoHS Compliant.

MECHANICAL:

- a) SHOCK: MIL-STD-883, Method 2002, Condition B
- b) SOLDERABILITY: JESD22-B102-D Method 2 (Preconditioning E)
- c) TERMINAL STRENGTH: MIL-STD-883, Method 2004, Test Condition D
- d) GROSS LEAK: MIL-STD-883, Method 1014, Condition C
- e) FINE LEAK: MIL-STD-883, Method 1014, Condition A2, $R1=2 \times 10^{-8}$ atm cc/s
- f) SOLVENT RESISTANCE: MIL-STD-202, Method 215

SUGGESTED IR REFLOW PROFILE

*As per IPC-JEDEC J-STD-020D

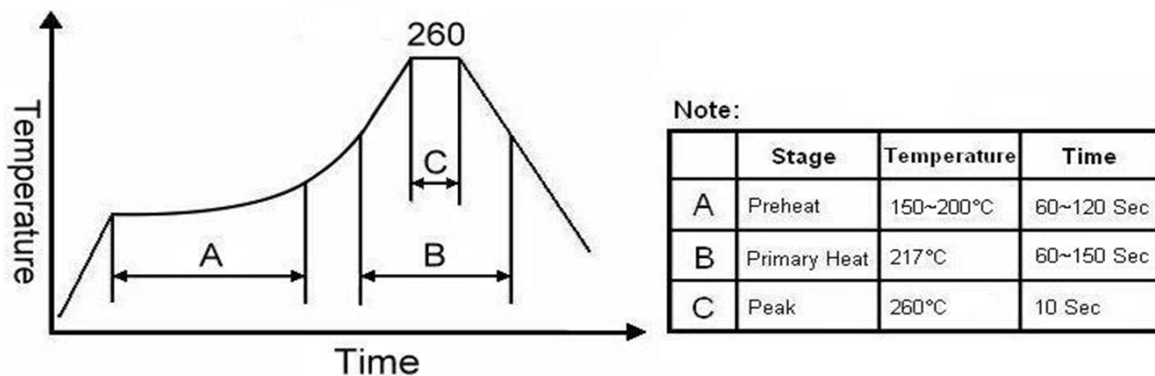

TYPE FK 3.2x2.5 SEAM SEALED CRYSTAL CLOCK OSCILLATOR

FK2400045

VER. B 24-Nov-17

MARKING

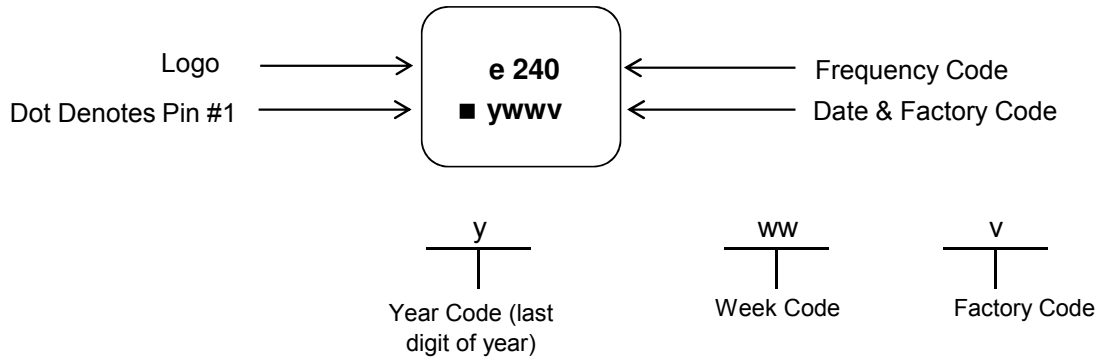

MECHANICAL DRAWINGS (Scale: None. Dimensions are in mm.)

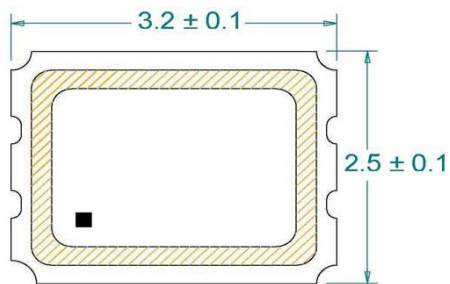

Recommended Land Pattern*

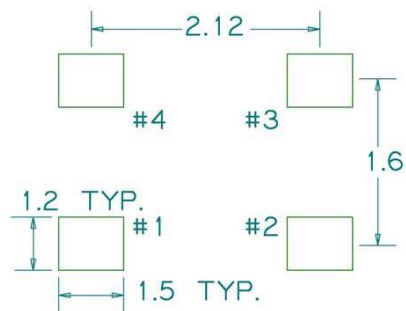

*External high-frequency power decoupling is recommended.(see test circuit for minimum recommendation). To ensure optimal performance, do not route traces beneath the package.

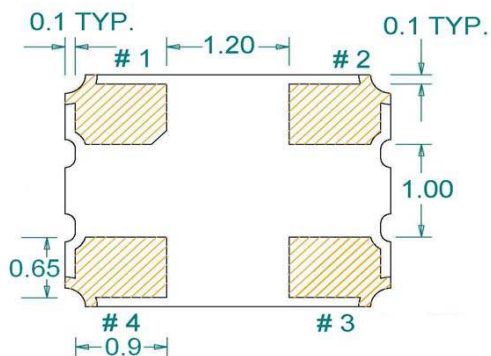

| Pin | Function |
|-----|-----------------|
| 1 | OE |
| 2 | Ground |
| 3 | Clock Output |
| 4 | V _{DD} |

TYPE FK 3.2x2.5 SEAM SEALED CRYSTAL CLOCK OSCILLATOR

FK2400045

VER. B 24-Nov-17

TAPE&REEL

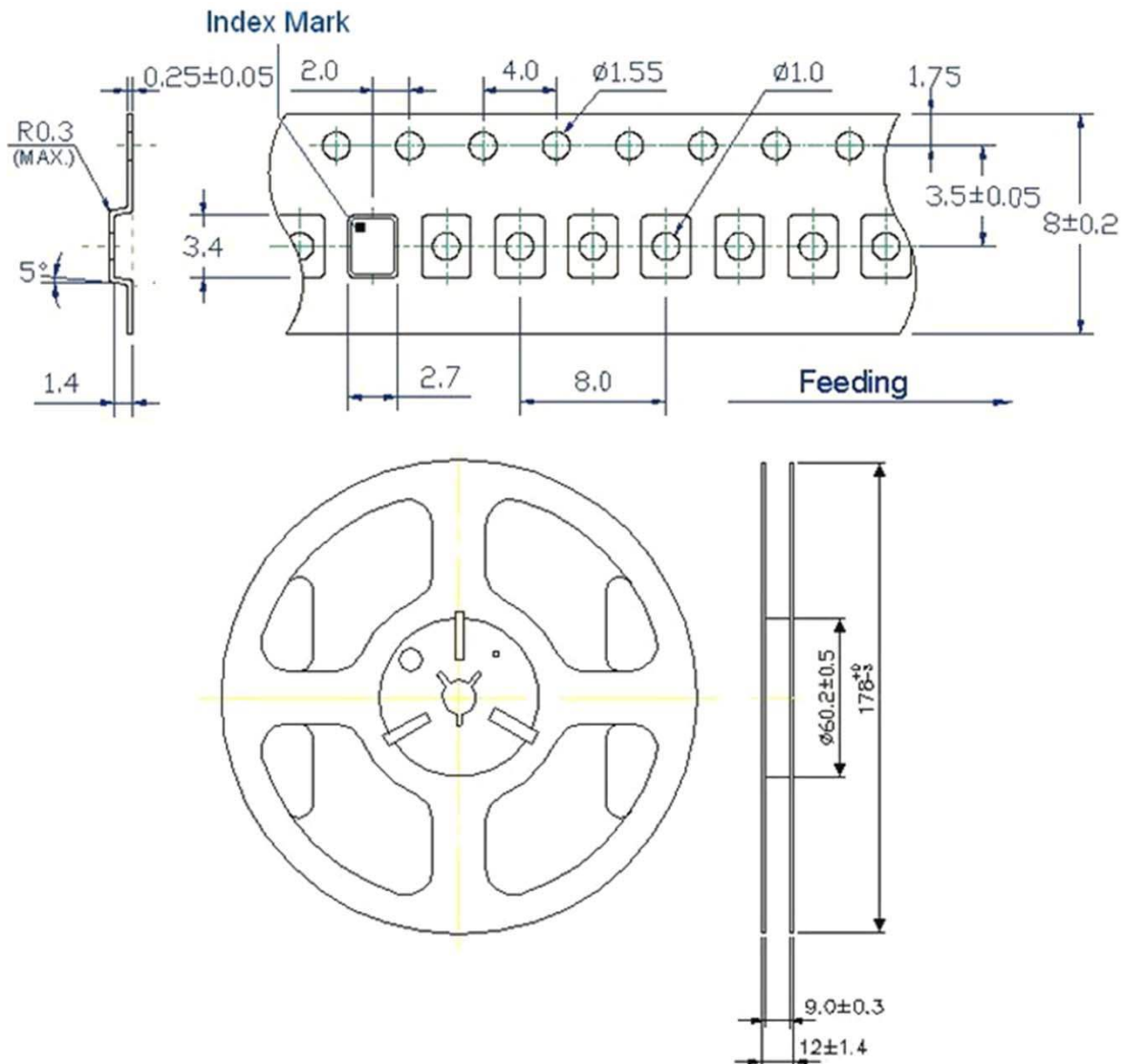

1. 230mm minimum leafer which consist of carrier and/or tape followed by a minimum of 160mm of empty carrier tape sealed with cover tape.
2. 160mm minimum trailer of empty carrier tape sealed with cover tape.

TYPE FK 3.2x2.5 SEAM SEALED CRYSTAL CLOCK OSCILLATOR

FK2400045

VER. B 24-Nov-17

PACKING

